



DVD PLAYER

OWNER'S MANUAL

MODEL : DV7942P



Before connecting, operating or adjusting this product,
please read this instruction booklet carefully and completely.



Safety Precautions



CAUTION
RISK OF ELECTRIC SHOCK
DO NOT OPEN



CAUTION: TO REDUCE THE RISK OF ELECTRIC SHOCK DO NOT REMOVE COVER (OR BACK) NO USER-SERVICEABLE PARTS INSIDE REFER SERVICING TO QUALIFIED SERVICE PERSONNEL.



This lightning flash with arrowhead symbol within an equilateral triangle is intended to alert the user to the presence of uninsulated dangerous voltage within the product's enclosure that may be of sufficient magnitude to constitute a risk of electric shock to persons.



The exclamation point within an equilateral triangle is intended to alert the user to the presence of important operating and maintenance (servicing) instructions in the literature accompanying the product.

WARNING: TO REDUCE THE RISK OF FIRE OR ELECTRIC SHOCK, DO NOT EXPOSE THIS PRODUCT TO RAIN OR MOISTURE.

WARNING: Do not install this equipment in a confined space such as a book case or similar unit.

CLASS 1 LASER PRODUCT
KLASSE 1 LASER PRODUKT
LUOKAN 1 LASER LAITE
KLASS 1 LASER APPARAT
CLASSE 1 PRODUIT LASER

CAUTION:

This Digital Video Disc Player employs a Laser System.

To ensure proper use of this product, please read this owner's manual carefully and retain for future reference should the unit require maintenance, contact an authorized service location (see service procedure).

Use of controls, adjustments, or the performance of procedures other than those specified herein may result in hazardous radiation exposure.

To prevent direct exposure to laser beam, do not try to open the enclosure. Visible laser radiation when open. DO NOT STARE INTO BEAM.

CAUTION: The apparatus should not be exposed to water (dripping or splashing) and no objects filled with liquids, such as vases, should be placed on the apparatus.



NOTES ON COPYRIGHTS:

It is forbidden by law to copy, broadcast, show, broadcast via cable, play in public, or rent copyrighted material without permission.

This product features the copy protection function developed by Macrovision. Copy protection signals are recorded on some discs. When recording and playing the pictures of these discs on a VCR, picture noise will appear.

This product incorporates copyright protection technology that is protected by method claims of certain U.S. patents and other intellectual property rights owned by Macrovision Corporation and other rights owners. Use of this copyright protection technology must be authorized by Macrovision Corporation, and is intended for home and other limited viewing uses only unless otherwise authorized by Macrovision Corporation. Reverse engineering or disassembly is prohibited.

SERIAL NUMBER: The serial number is found on the back of this unit. This number is unique to this unit and not available to others. You should record requested information here and retain this guide as a permanent record of your purchase.

Model No. _____

Serial No. _____



Table of Contents

Introduction

Safety Precautions	2
Table of Contents	3
Before Use	4-5
Playable Discs	4
Precautions	5
Notes on Discs	5
About Symbols	5
Front Panel and Display Window	6
Remote Control	7
Rear Panel	8

Preparation

Connections	9-10
Connecting to a TV	9
Connecting to Optional Equipment	10
Before Operation	11-14
General Explanation	11
On-Screen Display	11
Initial Settings	12-14
• <i>Initial Settings General Operation</i>	12
• <i>Language</i>	12
• <i>Picture</i>	12
• <i>Sound</i>	13
• <i>Others</i>	13
• <i>Parental Control</i>	14

Operation

Operation with DVD and Video CD	15-17
Playing a DVD and Video CD	15
General Features	15
• <i>Moving to another TITLE</i>	15
• <i>Moving to another CHAPTER/TRACK</i>	15
• <i>Search</i>	15
• <i>Still Picture and Frame-by-Frame Playback</i>	16
• <i>Slow Motion</i>	16
• <i>Random</i>	16
• <i>Repeat</i>	16
• <i>Repeat A-B</i>	16
• <i>Time Search</i>	16
• <i>3D Surround</i>	16
• <i>Zoom</i>	17
• <i>Marker Search</i>	17
Special DVD Features	17
• <i>Title Menu</i>	17
• <i>Disc Menu</i>	17
• <i>Camera Angle</i>	17
• <i>Changing the Audio Language</i>	17
• <i>Changing the Audio Channel</i>	17
• <i>Subtitle</i>	17

Operation with Audio CD and MP3/WMA Disc

Playing an Audio CD and MP3/WMA Disc	18
Notes on MP3/WMA Recordings	18
• <i>Pause</i>	19
• <i>Moving to another Track</i>	19
• <i>Repeat Track/ All/ Off</i>	19
• <i>Search</i>	19
• <i>Random</i>	19
• <i>Repeat A-B</i>	19
• <i>3D Surround</i>	19
• <i>Changing the Audio Channel</i>	19

Operation with JPEG Disc

Viewing a JPEG disc	20
• <i>Moving to another File</i>	20
• <i>Still Picture</i>	20
• <i>To flip picture</i>	20
• <i>To rotate picture</i>	20
• <i>Notes on JPEG Recordings</i>	20

Programmed Playback

Programmed Playback with Audio CD and MP3/WMA Disc	21
Programmed Playback with Video CD	21
• <i>Repeat Programmed Tracks</i>	21
• <i>Erasing a Track from Program List</i>	21
• <i>Erasing the Complete Program List</i>	21

Additional Information

Last Condition Memory	22
Screen Saver	22
System Select	22
Controlling the TV	22

Reference

Troubleshooting	23
Speaker Settings	24
Language Code List	25
Country Code List	26
Specifications	27

About the symbols for instructions

 Indicates hazards likely to cause harm to the unit itself or other material damage.



 Indicates special operating features of this unit.

 Indicates tips and hints for making the task easier.



Before Use

Playable Discs

	DVD (8 cm / 12 cm disc)
	Video CD (VCD) (8 cm / 12 cm disc)
	Audio CD (8 cm / 12 cm disc)

In addition, this unit can play a DVD-R, DVD±RW, Kodak PICTURE CD, SVCD, and CD-R or CD-RW that contains audio titles, MP3, WMA or JPEG files.

Notes

- Depending on the conditions of the recording equipment or the CD-R/RW (or DVD-R/±RW) disc itself, some CD-R/RW (or DVD-R/±RW) discs cannot be played on the unit.
- Do not attach any seal or label to either side (the labeled side or the recorded side) of a disc.
- Do not use irregularly shaped CDs (e.g., heart-shaped or octagonal). It may result in malfunctions.

Notes on DVDs and Video CDs

Some playback operations of DVDs and Video CDs may be intentionally fixed by software manufacturers. As this unit plays DVDs and Video CDs according to disc content designed by the software manufacturer, some playback features of the unit may not be available or other functions may be added.

Refer also to the instructions supplied with the DVDs and Video CDs. Some DVDs made for business purposes may not be played on the unit.

Regional code of the DVD player and DVDs

This DVD player is designed and manufactured for playback of region “2” encoded DVD software. The region code on the labels of some DVD discs indicates which type of player can play those discs. This unit can play only DVD discs labeled “2” or “ALL”. If you try to play any other discs, the message “Check Regional Code” will appear on the TV screen. Some DVD discs may not have a region code label even though their playback is prohibited by area limits.



Disc-related terms

Title (DVD only)

The main film content or accompanying feature content or additional feature content, or music album.

Each title is assigned a title reference number enabling you to locate it easily.

Chapter (DVD only)

Sections of a picture or a musical piece that are smaller than titles. A title is composed of one or several chapters. Each chapter is assigned a chapter number, enabling you to locate the chapter you want. Depending on the disc, chapters may not be recorded.

Track (Video CD and audio CD only)

Sections of a picture or a musical piece on a video CD or an audio CD. Each track is assigned a track number, enabling you to locate the track you want.

Scene

On a video CD with PBC (Playback control) functions, moving pictures and still pictures are divided into sections called “Scenes”. Each scene is displayed in the menu screen and assigned a scene number, enabling you to locate the scene you want.

A scene is composed of one or several tracks.

Types of video CDs

There are two types of video CDs:

Video CDs equipped with PBC (Version 2.0)

PBC (Playback control) functions allow you to interact with the system via menus, search functions, or other typical computer-like operations. Moreover, still pictures of high resolution can be played if they are included in the disc.

Video CDs not equipped with PBC (Version 1.1)

Operated in the same way as audio CDs, these discs allow playback of video pictures as well as sound, but they are not equipped with PBC.

Before Use (Continued)

Precautions

Handling the unit

When shipping the unit

The original shipping carton and packing materials come in handy. For maximum protection, re-pack the unit as it was originally packed at the factory.

When setting up the unit

The picture and sound of a nearby TV, VCR, or radio may be distorted during playback. In this case, position the unit away from the TV, VCR, or radio, or turn off the unit after removing the disc.

To keep the exterior surfaces clean

Do not use volatile liquids, such as insecticide spray, near the unit. Do not leave rubber or plastic products in contact with the unit for a long period of time. They will leave marks on the surface.

Cleaning the unit

To clean the cabinet

Use a soft, dry cloth. If the surfaces are extremely dirty, use a soft cloth lightly moistened with a mild detergent solution. Do not use strong solvents such as alcohol, benzene, or thinner, as these might damage the surface of the unit.

To obtain a clear picture

The DVD player is a high-tech, precision device. If the optical pick-up lens and disc drive parts are dirty or worn, the picture quality will be poor. Regular inspection and maintenance are recommended after every 1,000 hours of use. (This depends on the operating environment.)
For details, please contact your nearest dealer.

Notes on Discs

Handling discs

Do not touch the playback side of the disc.
Hold the disc by the edges so that fingerprints will not get on the surface.
Do not stick paper or tape on the disc.

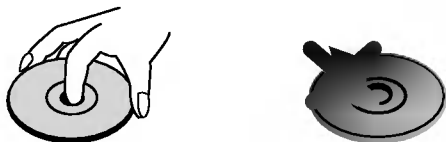

Storing discs

After playing, store the disc in its case. Do not expose the disc to direct sunlight or sources of heat, or leave it in a parked car exposed to direct sunlight, as there may be a considerable temperature increase inside the car.

Cleaning discs

Fingerprints and dust on the disc can cause poor picture quality and sound distortion. Before playing, clean the disc with a clean cloth. Wipe the disc from the center out.

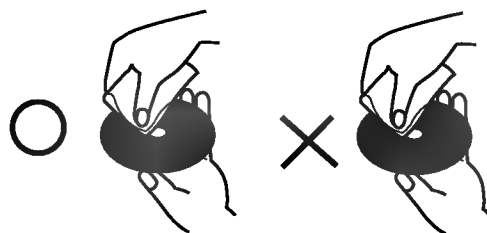

Do not use strong solvents such as alcohol, benzene, thinner, commercially available cleaners, or anti-static spray intended for older vinyl records.







About Symbols

About the symbol display

“” may appear on the TV screen during operation. This icon means the function explained in this owner’s manual is not available on that specific DVD video disc.

About the disc symbols for instructions

A section whose title has one of the following symbol is applicable only to the disc represented by the symbol.

-  DVD
-  Video CDs with the PBC (playback control) function.
-  Video CDs without the PBC (playback control) function.
-  Audio CDs.
-  MP3 disc.
-  WMA disc.
-  JPEG disc.



Front Panel and Display Window

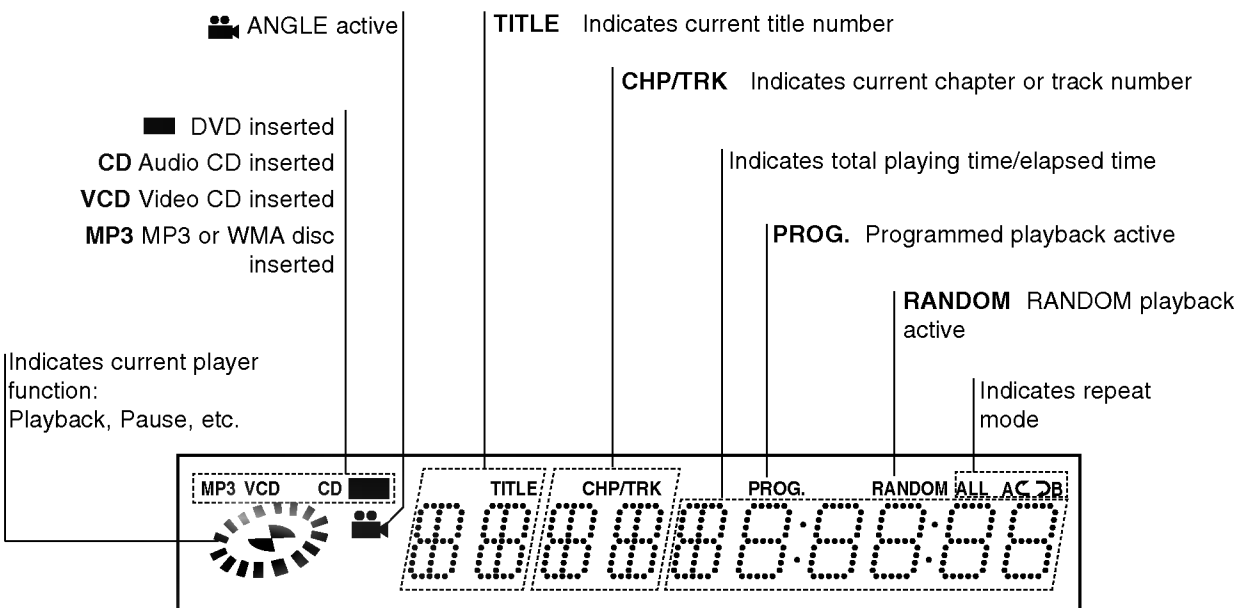
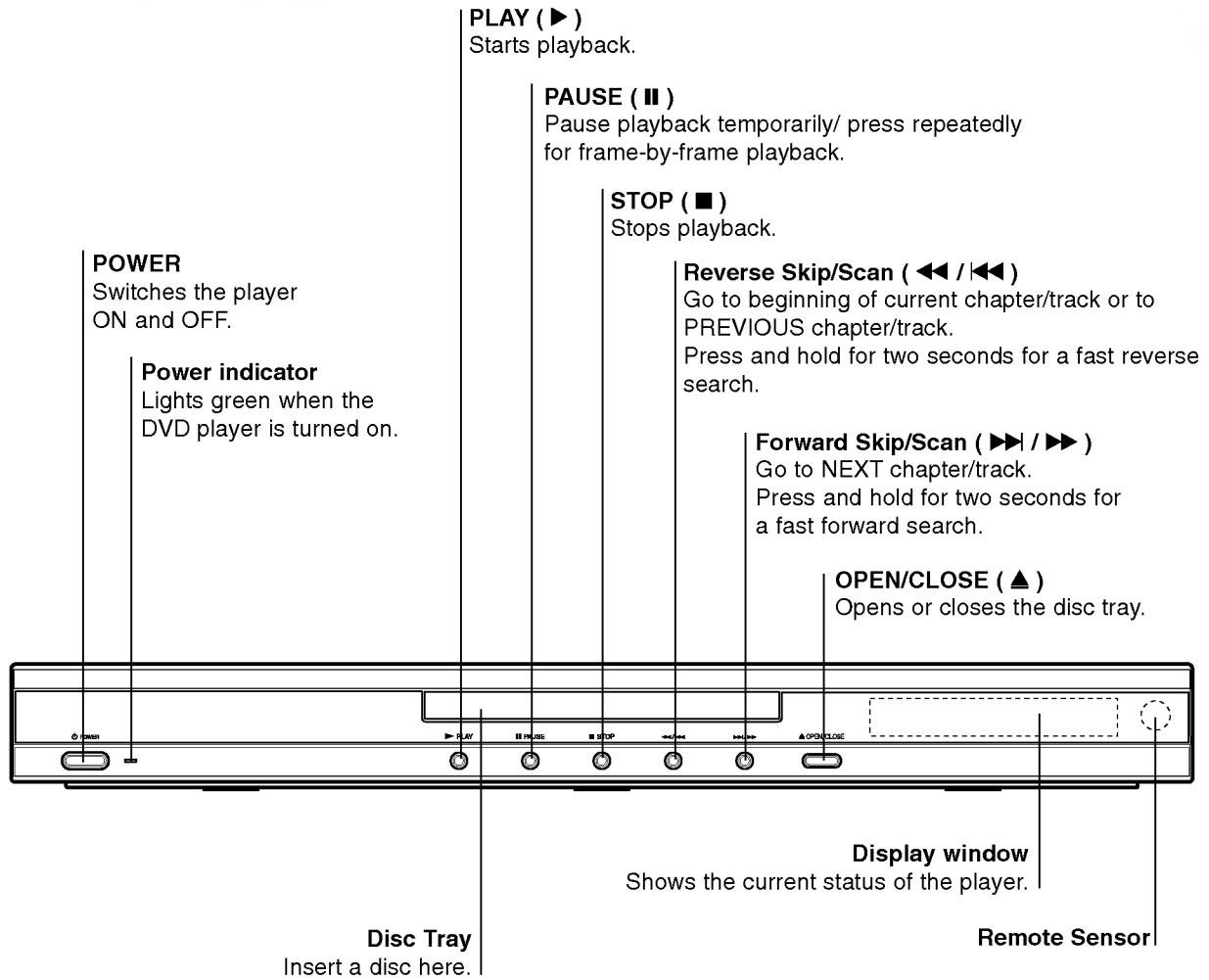

Remote Control

POWER
Switches DVD Player ON and OFF.

SOUND/MUTE
- Selects 3D SURROUND during disc playback.
- Turns off TV sound.

DVD
Selects operational mode of remote control to DVD.

DISPLAY
Accesses On-Screen display.

◀ ▶ ▲ ▼ (left/right/up/down)
- Selects an item in the menu.
- Selects channel of TV and changes volume of TV.

MENU
Accesses menu on a DVD disc.

PAUSE/STEP (⏸) •
Pauses playback temporarily/ press repeatedly for frame-by-frame playback.

SLOW (◀ / ▶) •
Reverse/ Forward slow playback.

STOP (■) •
Stops playback.

0-9 number buttons
Selects numbered items in a menu.

AUDIO •
Selects an audio language (DVD) or an audio channel (CD).

SUBTITLE •
Selects a subtitle language.

ANGLE •
Selects a DVD camera angle if available

SETUP •
Accesses or removes setup menu.

MARKER •
Marks any point during playback.

SEARCH •
Displays MARKER SEARCH menu.

OPEN/CLOSE
Opens and closes the disc tray.

This button is not available.

TV
Selects operational mode of remote control to TV.

RETURN/TV AV
- Removes the setup menu.
- Displays the menu of a video CD with PBC.
- Selects AUX AV input channel of TV.

SELECT/ENTER
Acknowledges menu selection.

TITLE
Displays the discs Title menu, if available.

• **Forward SKIP/SCAN (▶▶)**
Search forward*/ go to next chapter or track.

• **PLAY (▶)**
Starts playback.

• **Reverse SKIP/SCAN (◀◀)**
Search backward*/ go to beginning of current chapter or track or go to previous chapter or track.

* Press and hold button for about two seconds.

PROGRAM
Enters to the program edit mode or exits from that.

CLEAR
Removes a track number on the program list or a mark on the MARKER SEARCH menu.

• **REPEAT**
Repeat chapter, track, title, all.

• **A-B**
Repeat sequence.

• **RANDOM**
Plays tracks in random order.

• **ZOOM**
Enlarges video image.

Remote control battery installation

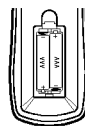

Detach the battery cover on the rear of the remote control, and insert two R03 (size AAA) batteries with + and - aligned correctly.



Caution
Do not mix old and new batteries. Never mix different types of batteries (standard, alkaline, etc.).

Remote Control Operation Range

Point the remote control at the remote sensor and press the buttons.

- **Distance:** About 23 ft (7 m) from the front of the remote sensor.
- **Angle:** About 30° in each direction of the front of the remote sensor.



Rear Panel

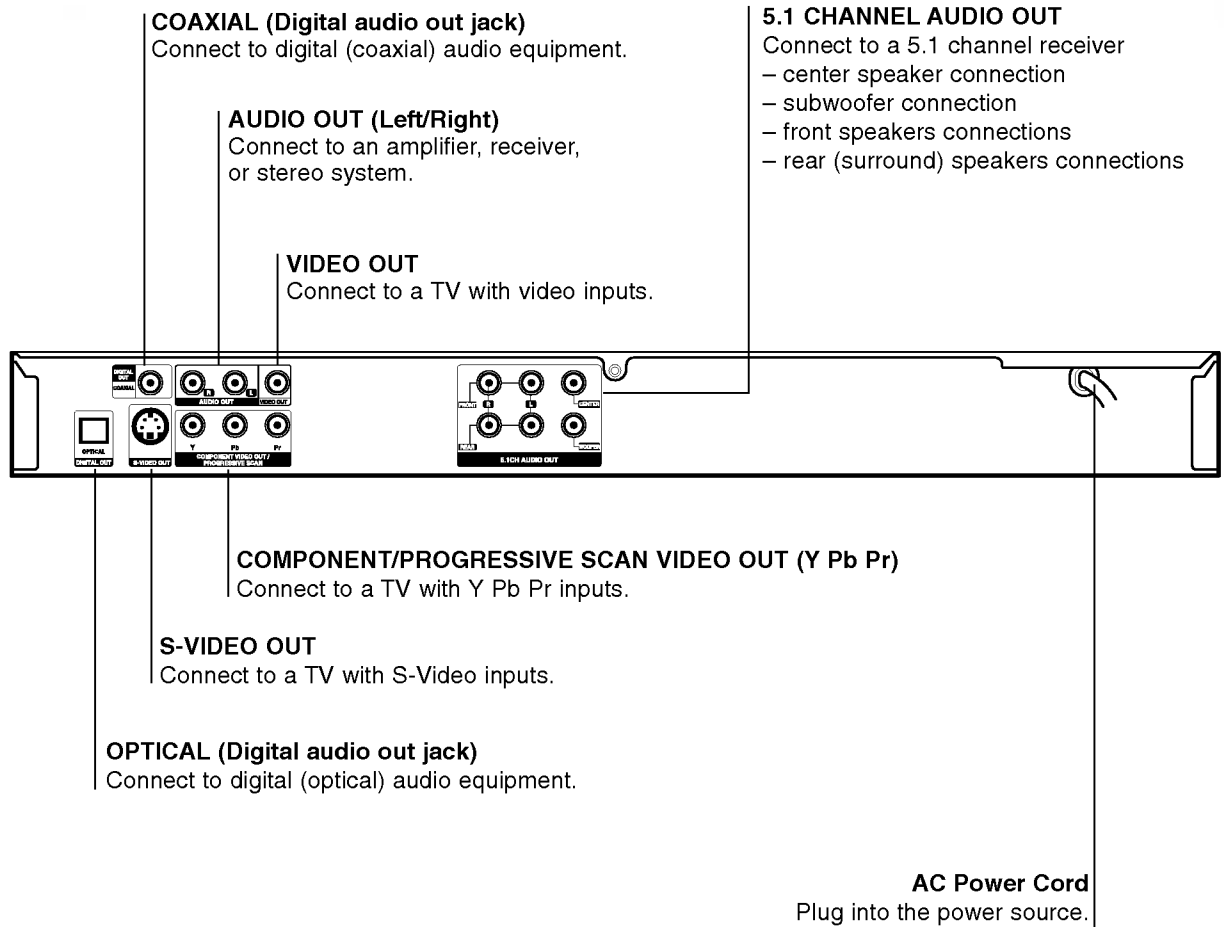

Do not touch the inner pins of the jacks on the rear panel. Electrostatic discharge may cause permanent damage to the unit.



Connections

Tips

- Depending on your TV and other equipment you wish to connect, there are various ways you could connect the player. Use only one of the connections described below.
- Please refer to the manuals of your TV, VCR, Stereo System or other devices as necessary to make the best connections.
- For better sound reproduction, connect the player's AUDIO OUT jacks to the audio in jacks of your amplifier, receiver, stereo or audio/video equipment. See "Connecting to Optional Equipment" on 10.

Caution

- Make sure the DVD Player is connected directly to the TV. Tune the TV to the correct video input channel.
- Do not connect the DVD Player's AUDIO OUT jack to the phono in jack (record deck) of your audio system.
- Do not connect your DVD Player via your VCR. The DVD image could be distorted by the copy protection system.

Connecting to a TV

- Make one of the following connections, depending on the capabilities of your existing equipment.

Video connection

- 1 Connect the VIDEO OUT jack on the DVD Player to the video in jack on the TV using the video cable (V).
- 2 Connect the Left and Right AUDIO OUT jacks of the DVD Player to the audio left/right in jacks on the TV (A) using the audio cables.

S-Video connection

- 1 Connect the S-VIDEO OUT jack on the DVD Player to the S-Video in jack on the TV using the S-Video cable (S).
- 2 Connect the Left and Right AUDIO OUT jacks of the DVD Player to the audio left/right in jacks on the TV (A) using the audio cables.

Component Video (Color Stream®) connection

- 1 Connect the COMPONENT VIDEO OUT/ PROGRESSIVE SCAN jacks on the DVD Player to the corresponding in jacks on the TV using an Y Pb Pr cable (C).
- 2 Connect the Left and Right AUDIO OUT jacks of the DVD Player to the audio left/right in jacks on the TV (A) using the supplied audio cables.

Progressive Scan (ColorStream® pro) connection

- If your television is a high-definition or "digital ready" television, you may take advantage of the DVD Player's progressive scan output for the highest video resolution possible.
- If your TV does not accept the Progressive Scan format, the picture will appear scrambled if you try Progressive Scan on the DVD Player.

- 1 Connect the COMPONENT VIDEO OUT/ PROGRESSIVE SCAN jacks on the DVD Player to the corresponding in jacks on the TV using an optional Y Pb Pr cable (C).
- 2 Connect the Left and Right AUDIO OUT jacks of the DVD Player to the audio left/right in jacks on the TV (A) using the supplied audio cables.

Notes

- Set the Progressive to "On" on the setup menu for progressive signal, see page 12.
- Progressive scan does not work with the analog video connections (yellow VIDEO OUT jack).

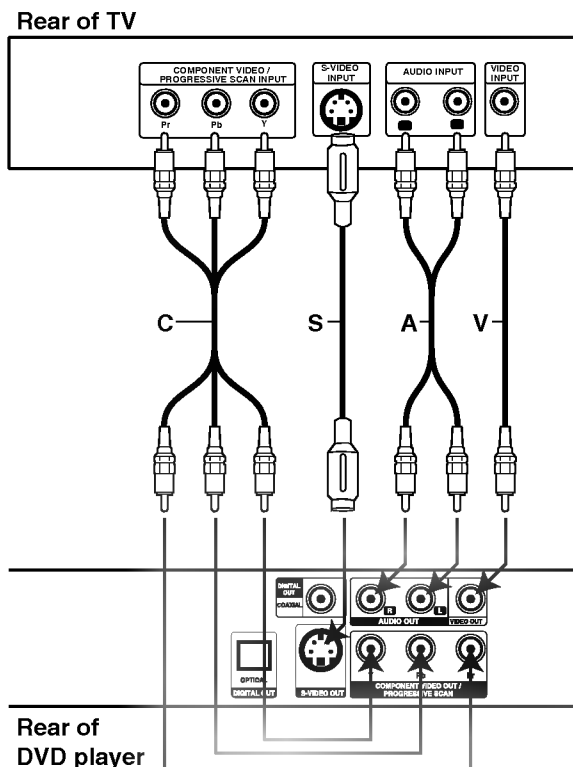

Connections (Continued)

Connecting to Optional Equipment

Connecting to an amplifier equipped with two channel analog stereo or Dolby Pro Logic II/ Pro Logic

Connect the Left and Right AUDIO OUT jacks on the DVD Player to the audio left and right in jacks on your amplifier, receiver, or stereo system, using the audio cables (A).

Connecting to an amplifier equipped with two channel digital stereo (PCM) or to an Audio/ Video receiver equipped with a multi-channel decoder (Dolby Digital™, MPEG 2, or DTS)

- 1 Connect one of the DVD Player's DIGITAL AUDIO OUT jacks (OPTICAL O or COAXIAL X) to the corresponding jack on your amplifier. Use an optional digital (optical O or coaxial X) audio cable.
- 2 You will need to activate the player's digital output. (See "Digital Audio Output" on page 13).

Digital Multi-channel sound

A digital multi-channel connection provides the best sound quality. For this you need a multi-channel Audio/Video receiver that supports one or more of the audio formats supported by your DVD Player (MPEG 2, Dolby Digital and DTS). Check the receiver manual and the logos on the front of the receiver.

Caution:

Due to the DTS Licensing agreement, the digital output will be in DTS digital out when DTS audio stream is selected.

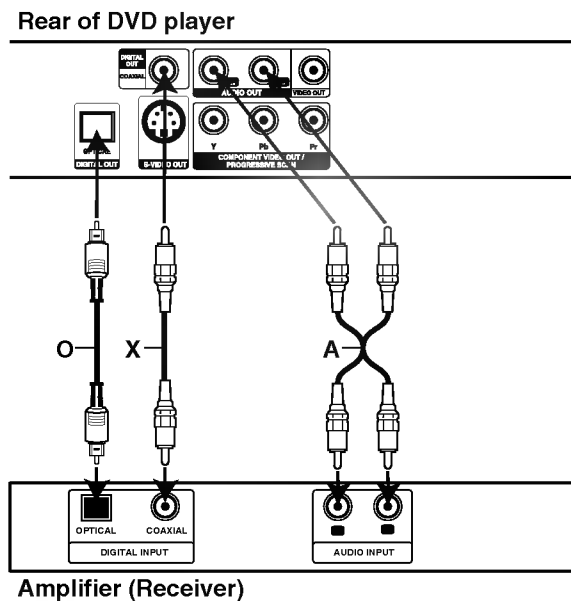

Notes

- If the audio format of the digital output does not match the capabilities of your receiver, the receiver will produce a strong, distorted sound or no sound at all.
- Six Channel Digital Surround Sound via digital connection can only be obtained if your receiver is equipped with a Digital Multi-channel decoder.
- To see the audio format of the current DVD in the on-screen display, press AUDIO.

Analog connection to a multi-channel A/V receiver with 6 Channel connectors (Dolby Digital)

This DVD Player contains a multi-channel decoder. This enables playback of DVDs recorded in Multi-channel Surround without the need for an optional decoder.

- 1 Connect the CENTER and WOOFER jacks for the Center speaker and the Subwoofer (C) to the corresponding in jacks on your receiver.
- 2 Connect the Left and Right FRONT speaker jacks (F) to the corresponding in jacks on your receiver.
- 3 Connect the Left and Right REAR speaker jacks (R) to the corresponding in jacks on your receiver.
- 4 Make the appropriate Sound settings for Analog Output and Speaker Settings in the setup menu. See page 13.

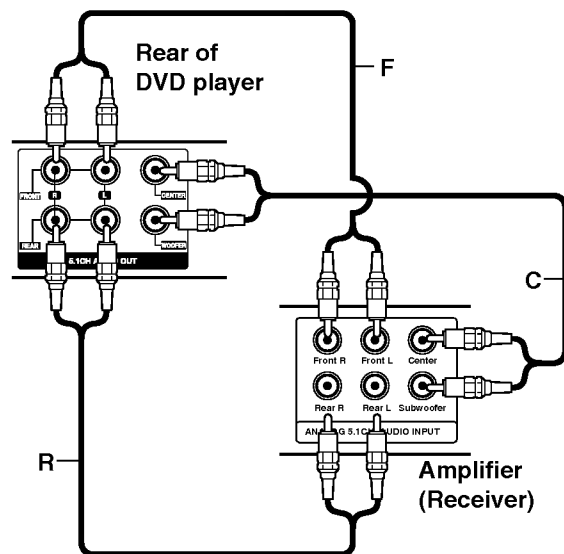

Before Operation

Caution:

Before using the remote control, press the DVD or TV button to select the device to be operated.

General Explanation

This manual gives basic instructions for operating the DVD Player. Some DVDs require specific operation or allow only limited operation during playback. When this occurs, the symbol  appears on the TV screen, indicating that the operation is not permitted by the DVD Player or is not available on the disc.

On-Screen Display

General playback status can be displayed on the TV screen. Some items can be changed on the menu.

On-screen display operation









1 Press DISPLAY during playback.

2 Press ▲/▼ to select an item.
The selected item will be highlighted.

3 Press ◀▶ to change the setting of an item.







The number buttons can be also be used for setting numbers (e.g., title number). For some functions, press SELECT/ENTER to execute the setting.





Temporary Feedback Field Icons

	Repeat Title
	Repeat Chapter
	Repeat Track (non-PBC Video CDs only)
	Repeat All Tracks (non-PBC Video CDs only)
	Repeat A-B
	Repeat Off
	Resume play from this point
	Action prohibited or not available

Notes

- Some discs may not provide all of the features on the on-screen display example shown below.
- If no button is pressed for 10 seconds, the on-screen display disappears.

Items		Function (Press ▲/▼ to select desired item)	Selection Method
Title Number	 1 / 3	Shows the current title number and total number of titles, and skips to the desired title number.	◀ / ▶, or Numbers, SELECT/ENTER
Chapter Number	 1 / 12	Shows the current chapter number and total number of chapters, and skips to the desired chapter number.	◀ / ▶, or Numbers, SELECT/ENTER
Time search	 0:20:09	Shows the elapsed playing time, and searches the point by the elapsed time directly.	Numbers, SELECT/ENTER
Audio language and Digital Audio Output mode	 1 ENG D D D 5.1 CH	Shows the current audio soundtrack language, encoding method, and channel number, and changes the setting.	◀ / ▶, or AUDIO
Subtitle language		Shows the current subtitles language, and changes the setting.	◀ / ▶, or SUBTITLE
Angle		Shows the current angle number and total number of angles, and changes the angle number.	◀ / ▶, or ANGLE
Sound	 NORM.	Shows the current sound mode, and changes the setting.	◀ / ▶

Items		Function (Press ▲/▼ to select desired item)	Selection Method
Track Number	 1 / 4	Shows the current track number, total number of tracks and PBC On mode, and skip to the desired track number.	◀ / ▶, or Numbers, SELECT/ENTER
Time	 0:20:09	Shows the elapsed playing time (Display only)	-
Audio Channel	 STER.	Shows the audio channel, and changes the audio channel.	◀ / ▶, or AUDIO
Sound	 NORM.	Shows the current sound mode, and changes the setting.	◀ / ▶

Before Operation (Continued)

Initial Settings

You can set your own Personal Preferences on the player.

Initial Settings General Operation

- 1 Press SETUP.**
The setup menu appears.

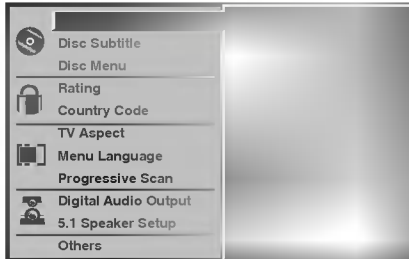

- 2 Press ▲▼ to select the desired item.**
The screen will show the current setting for the selected item, as well as alternate setting(s).
- 3 While the desired item is selected, press ►, then ▲▼ to select the desired setting.**
- 4 Press SELECT/ENTER to confirm your selection.**
Some items require additional steps.
- 5 Press SETUP, RETURN, or PLAY to exit the setup menu.**

Language

Disc Language

Select a language for the disc's Menu, Audio, and Subtitle.

Original : The original language set for the disc is selected.
Other : To select another language, press number buttons to enter the corresponding 4-digit number according to the language code list on page 25. If you enter the wrong language code, press CLEAR.

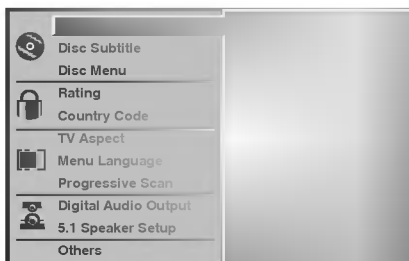

Menu Language

Select a language for the setup menu. This is the menu you see when you press SETUP.

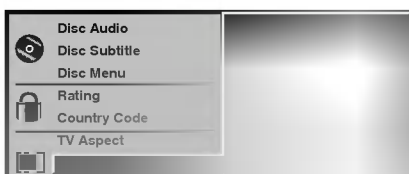

Picture

TV Aspect

4:3 Letterbox: Select when a standard 4:3 TV is connected. Displays theatrical images with masking bars above and below the picture.

4:3 Panscan: Select when a conventional TV set is connected. The video material formatted in the Pan & Scan style is played back in that style (Both sides of the picture are cut off).

16:9 Wide: Select when a 16:9 wide TV is connected.



Progressive Scan

Progressive Scan Video provides the highest quality pictures with less flickering.

If you are using the COMPONENT VIDEO OUT/ PROGRESSIVE SCAN jacks, but are connecting the DVD Player to a standard (analog) television, set Progressive Scan to Off.

If you are using the Component Video jacks for connection to a TV or monitor that is compatible with a progressive scan signal, set Progressive Scan to On.

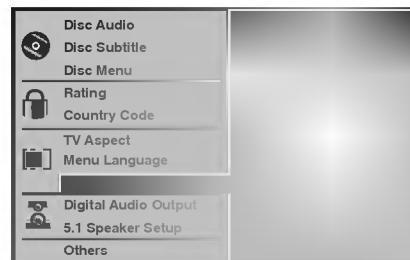

Note

Progressive Scan only works when the system is set to NTSC or AUTO. Also if the system is set to AUTO, Progressive Scan only works during DVD of NTSC system is playing back .

Caution

Once the setting for progressive scan output is entered, an image will only be visible on a progressive scan compatible TV or monitor. If you set Progressive Scan to On in error, you must reset the unit. Press STOP to stop any disc that is playing. Next, press STOP again and hold it for five seconds before releasing it. The video output will be restored to the standard setting, and a picture will once again be visible on a conventional analog TV or monitor.

Before Operation (Continued)

Sound

Digital Audio Output

Each DVD disc has a variety of audio output options. Set the player's Digital Audio Output according to the type of audio system you use.

DOLBY DIGITAL/PCM: Select "DOLBY DIGITAL/PCM" if you connected the DVD Player's DIGITAL OUT jack to a Dolby Digital decoder (or an amplifier or other equipment with a Dolby Digital decoder).

Stream/PCM: Select "Stream/PCM" if you connected the DVD Player's DIGITAL OUT jack to an amplifier or other equipment with a DTS decoder, Dolby Digital decoder or MPEG decoder.

PCM: Select when connected to a 2-channel digital stereo amplifier. The DVD player outputs sounds in the PCM 2ch format when you play a DVD video disc recorded on the Dolby Digital, MPEG1, or MPEG2 recording system.

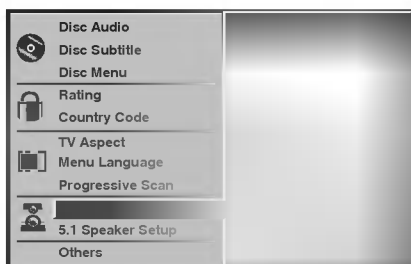

Sample Frequency

To change the Sample Frequency setting, first select the desired Digital Audio Output as indicated as above. If your receiver or amplifier is NOT capable of handling 96KHz signals, select 48KHz. When this choice is made, this unit will automatically convert any 96KHz signals to 48KHz so your system can decode them. If your receiver or amplifier is capable of handling 96KHz signals, select 96KHz. When this choice is made, this unit will pass each type of signal through without any further processing.

5.1 Speaker settings

Select speaker settings, including volume balance and delay time, or test the speaker settings.

Speaker settings are only active on the Analog Multi-Channel Output. (See "Speaker Settings", page 24.)

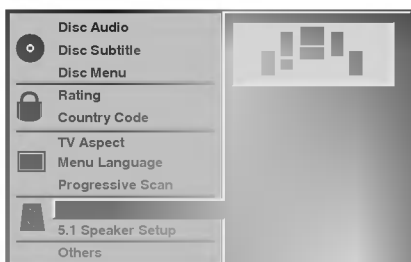

Others

The DRC, Vocal, PBC and Auto Play settings can be changed.

- Press ▲/▼ to select the desired item and press SELECT/ENTER. The setting of the selected item is changed between On and Off.

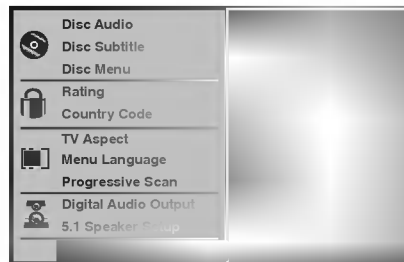

Dynamic Range Control (DRC)

With the DVD format, you can hear a program's soundtrack in the most accurate and realistic presentation possible, thanks to digital audio technology. However, you may wish to compress the dynamic range of the audio output (the difference between the loudest sounds and the quietest ones). Then, you may listen to a movie at a lower volume without losing clarity of sound. Set DRC to On for this effect.

PBC

Set Playback Control (PBC) to On or Off.

On: Video CDs with PBC are played according to the PBC.

Off: Video CDs with PBC are played the same way as Audio CDs.

Vocal

Set Vocal to On only when a multi-channel karaoke DVD is playing. The karaoke channels on the disc will mix into normal stereo sound.

Auto Play

You can set up the DVD Player so a DVD disc automatically starts playing whenever the DVD is inserted.

If Auto Play mode is set to On, this DVD player will search a title that playback time is long most and then play back the title automatically.

On: Auto Play function is activated.

Off: Auto Play function is not activated.



Note

The Auto Play function may not work for some DVDs.

Before Operation (Continued)

Parental Control

Rating

Movies on DVDs may contain scenes not suitable for children. Therefore, discs may contain Parental Control information that applies to the complete disc or to certain scenes on the disc. These scenes are rated from 1 to 8, and alternatively, more suitable scenes are available for selection on some discs. Ratings are country-dependent. The Parental Control feature allows you to prevent discs from being played by your children or to have certain discs played with alternative scenes.

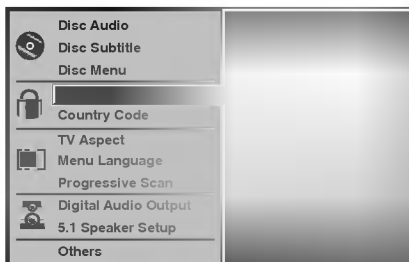

1 Select "Rating" on the Setup menu using the ▲▼ buttons.

2 While "Rating" is selected, press ►.

3 When you have not entered a password yet. Enter a 4-digit password using the numbered buttons to create a personal 4-digit security password. then press SELECT/ENTER. Enter the 4-digit password again and press SELECT/ENTER to verify. **When you have already entered a password;** Enter a 4-digit password using the numbered buttons to confirm the personal 4-digit security password, then press SELECT/ENTER.

If you make a mistake before pressing SELECT/ENTER, press CLEAR and enter 4-digit security password again.

4 Select a rating from 1 to 8 using the ▲▼ buttons. One (1) has the least playback restrictions. Eight (8) has the most playback restrictions.

Unlock: If you select Unlock, Parental Control is not active. The disc will play in full.

Ratings 1 to 8: Some discs contain scenes not suitable for children. If you set a rating for the player, all disc scenes with the same rating or lower will be played. Higher rated scenes will not be played unless an alternative scene is available on the disc. The alternative must have the same rating or a lower one. If no suitable alternative is found, playback will stop. You must enter the 4-digit password or change the rating level in order to play the disc.

5 Press SELECT/ENTER to confirm your rating selection, then press SETUP to exit the menu.

Country Code

Enter the code of a country/area whose standards were used to rate the DVD video disc, referring to the list (See "Country Code List", page 26.).

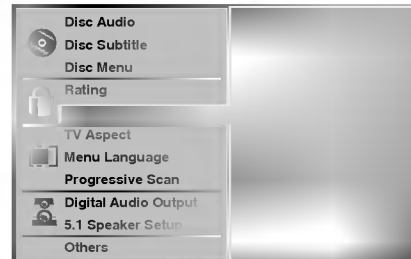

1 Select Country Code using the ▲▼ buttons on the setup menu.

2 While Country Code is selected, press ►.

3 Follow step 3 of "Rating" on left.

4 Select the first character using the ▲▼ buttons.

5 Shift the cursor using ► button and select the second character using ▲▼ buttons.

6 Press SELECT/ENTER to confirm your country code selection, then press SETUP to exit the menu.

Note

Confirmation of the 4-digit password is necessary when the code is changed (see "Changing the 4-digit code" below.).

Changing the 4-digit code

- 1 Follow Steps 1-2 as shown above to the left (Rating).
- 2 Enter the old code, then press SELECT/ENTER.
- 3 Select Change using ▲▼ buttons then press SELECT/ENTER.
- 4 Enter the new 4-digit code, then press SELECT/ENTER.
- 5 Enter exactly the same code a second time and verify by pressing SELECT/ENTER.
- 6 Press SETUP to exit the menu.

If you forget your 4-digit code

If you forget your password, to clear the current password, follow the procedure below.

- 1 Press SETUP to display the setup menu.
- 2 Use the Number buttons to enter the 6-digit number "210499".
The 4-digit password is cleared. "P CLR" appears on the display for a moment.
- 3 Enter a new code as shown above to the left (Rating).



Operation with DVD and Video CD

Playing a DVD and Video CD

Playback Setup

- Turn on the TV and select the video input source connected to the DVD player.
- Audio system: Turn on the audio system and select the input source connected to the DVD player.





1 Press OPEN/CLOSE to open the disc tray.

2 Load your chosen disc in the tray, with the playback side down.

3 Press OPEN/CLOSE to close the tray. READING appears on the TV screen, and playback starts automatically. If playback does not start, press PLAY.
In some cases, the disc menu might appear instead.

If a menu screen is displayed

The menu screen may be displayed first after loading a DVD or Video CD which offer a menu.

 Use the     buttons to select the title/chapter you want to view, then press SELECT/ENTER to start playback.
Press TITLE or MENU to return to the menu screen.

- 
- Use the number buttons to select the track you want to view.
Press RETURN to return to the menu screen.
 - Menu setting and the exact operating procedures for using the menu may differ depending on the disc. Follow the instructions on the each menu screen. You also may set PBC to Off under setup. See page 13.

Notes

- If Parental Control is set and the disc is not within the Rating settings (not authorized), the 4-digit code must be entered and/or the disc must be authorized (see “Parental Control”, on page 14).
- DVDs may have a region code.
Your player will not play discs that have a region code different from your player. The region code for this player is 2 (two).

General Features

Note

Unless stated otherwise, all operations described use the remote control. Some features may also be available on the Setup menu.

Moving to another TITLE









When a disc has more than one title, you can move to another title as follows:

- Press DISPLAY, then press the appropriate numbered button (0-9) to select a title number.

Moving to another CHAPTER/TRACK





























When a title on a disc has more than one chapter or a disc has more than one track, you can move to another chapter/track as follows:

- Press SKIP/SCAN   or  briefly during playback to select the next chapter/track or to return to the beginning of the current chapter/track.
- Press  twice briefly to step back to the previous chapter/track.
- To go directly to any chapter during DVD playback, press DISPLAY. Then, press   to select the chapter/track icon. Then, enter the chapter/track number using the numbered buttons (0-9).

Note

For two-digit numbers, press the numbered buttons (0-9) in rapid succession.

Search

- 1 Press and hold SKIP/SCAN   or  for about two seconds during playback.
The player will now go into SEARCH mode.
- 2 Press and hold SKIP/SCAN   repeatedly to select the required speed:   X2,   X4,   X16,   X100 (backward) or  X2,  X4,  X16,  X100 (forward).
With a Video CD, the Search speed changes:   X2,   X4,   X8, (backward) or  X2,  X4,  X8, (forward).
- 3 To exit SEARCH mode, press PLAY.

Operation with DVD and Video CD

General Features (continued)

Still Picture and Frame-by-frame playback



- 1 Press PAUSE/STEP during playback.
The player will now go into PAUSE mode.
- 2 You can advance the picture frame-by-frame by pressing PAUSE/STEP repeatedly on the remote control.

Slow Motion



- 1 Press SLOW ◀ or ▶ during playback.
The player will enter SLOW mode.
- 2 Use the SLOW ◀ or ▶ to select the required speed:
◀ 1/16, ◀ 1/8, ◀ 1/4 or ◀ 1/2 (backward), or
▶ 1/16, ▶ 1/8, ▶ 1/4 or ▶ 1/2 (forward).
- 3 To exit slow motion mode, press PLAY.



Note

Slow motion playback in reverse is not applicable for Video CD.

Random



- 1 Press RANDOM during playback or in stop mode.
The unit automatically begins Random Playback and "RANDOM" appears on the display window.
- 2 To return to normal playback, press RANDOM until "RANDOM" disappears on the display window.



Tip

By pressing SKIP/SCAN ▶▶ during Random playback, the unit selects another title (track) and resumes Random playback.



Note

- This function only works with DVD Karaoke discs and video CD without PBC.
- On a Video CD with PBC, you must set PBC to Off on the setup menu to use the Random function. See page 13.

Repeat



DVD Video Discs - Repeat Chapter/Title/Off

- 1 To repeat the currently playing chapter, press REPEAT.
The Repeat Chapter icon appears on the TV screen.
- 2 To repeat the title currently playing, press REPEAT a second time.
The Repeat Title icon appears on the TV screen.
- 3 To exit Repeat mode, press REPEAT a third time.
The Repeat Off icon appears on the TV screen.

Video CDs - Repeat Track/All/Off

- 1 To repeat the track currently playing, press REPEAT.
The Repeat Track icon appears on the TV screen.
- 2 To repeat the disc currently playing, press REPEAT a second time.
The Repeat All icon appears on the TV screen.
- 3 To exit Repeat mode, press REPEAT a third time.
The Repeat Off icon appears on the TV screen.



Note

On a Video CD with PBC, you must set PBC to Off on the setup menu to use the Repeat function. See page 13.

Repeat A-B



To repeat a sequence in a title:

- 1 Press A-B at your chosen starting point.
"A" appears briefly on the TV screen.
- 2 Press A-B again at your chosen end point.
"A B" appears briefly on the TV screen, and the repeat sequence begins ("A↔B" appears the display window).
- 3 To cancel the sequence, press A-B.

Time Search



The Time Search function allows you to start playing at any chosen time on the disc.

- 1 Press DISPLAY during playback. The on-screen display appears on the screen.
The Time Search box shows the elapsed playing time of the current disc.
- 2 Within 10 seconds, press ▲/▼ to select the Time Search icon in the on-screen display.
The ":-:--" appears in the Time Search box.
- 3 Within 10 seconds, use the number buttons to enter the required start time. Enter hours, minutes, and seconds from left to right in the box.
If you enter the wrong numbers, press CLEAR to remove the numbers you entered. Then enter the correct numbers.
- 4 Within 10 seconds, press SELECT/ENTER to confirm the start time.
Playback starts from the selected time on the disc. If you enter an invalid time, playback will continue from the current point.

3D Surround



This unit can produce a 3D Surround effect, which simulates multi-channel audio playback from two conventional stereo speakers, instead of the five or more speakers normally required to listen to multi-channel audio from a home theater system.

- 1 Press SOUND to select "3D SUR" during playback.
- 2 To turn off the 3D Surround effect, press SOUND again to select "NORM".



Operation with DVD and Video CD

General Features (continued)

Zoom

The Zoom function allows you to enlarge the video image and to move through the enlarged image.

- 1 Press ZOOM during playback or still playback to activate the Zoom function.
If you press ZOOM repeatedly, the magnification level increases up to six steps.
- 2 Use the ◀▶▲▼ buttons to move through the zoomed picture.
- 3 Press CLEAR to resume normal playback or return to the paused image.

Note

- The zoom function may not work for some DVDs.

Marker Search



You can start playback from a memorized point. Up to nine points can be memorized.

To enter a mark, follow these steps.

- 1 During disc playback, press MARKER when playback reaches the spot that you want to memorize.
The Marker icon will appear on the TV screen briefly.
- 2 Repeat step 1 to enter up to nine Marker points on a disc.

To Recall a Marked Scene

- 1 During disc playback, press SEARCH.
The MARKER SEARCH menu will appear on the screen.
- 2 Within 10 seconds, press ◀▶ to select a Marker number that you want to recall.
- 3 Press SELECT/ENTER.
Playback will start from the Marked scene.
- 4 To remove the MARKER SEARCH menu, press SEARCH.

To clear a Marked Scene

- 1 During disc playback, press SEARCH.
The MARKER SEARCH menu will appear on the screen.
- 2 Press ◀▶ to select the Marker number that you want to erase.
- 3 Press CLEAR.
The Marker number will be erased from the list.
- 4 Repeat steps 2 and 3 to erase additional Marker numbers.
- 5 To remove the MARKER SEARCH menu, press SEARCH.

Special DVD Features

Checking the contents of DVD Video discs: Menus

DVDs may offer menus that allow you to access special features. To use the disc menu, press MENU. Then, press the appropriate number button to select an option. Or, use the ◀▶▲▼ buttons to highlight your selection, then press SELECT/ENTER.

Title Menu

- 1 Press TITLE.
If the current title has a menu, the menu will appear on the screen. Otherwise, the disc menu may appear.
- 2 The menu can list camera angles, spoken language and subtitle options, and chapters for the title.
- 3 To remove the title menu, press TITLE again.

Disc Menu

- 1 Press MENU.
The disc menu is displayed.
- 2 To remove the disc menu, press MENU again.

Camera Angle

If the disc contains scenes recorded at different camera angles, you can change to a different camera angle during playback.

- Press ANGLE repeatedly during playback to select a desired angle.
The number of the current angle appears on the display.

Changing the Audio Language

Press AUDIO repeatedly during playback to hear a different audio language or audio track.

Changing the Audio Channel

Press AUDIO repeatedly during playback to hear a different audio channel (STER., LEFT or RIGHT).

Subtitles

Press SUBTITLE repeatedly during playback to see the different subtitle languages.

Note

If Ⓞ appears, the feature is not available on the disc.

Operation with Audio CD and MP3/WMA Disc

Playing an Audio CD and MP3/WMA Disc



The DVD Player can play MP3/WMA formatted recordings on CD-ROM, CD-R or CD-RW discs. Before playing MP3/WMA recordings, read the notes on MP3/WMA Recordings on right.

- 1 Insert a disc and close the tray.**
Audio CD; Audio CD menu appears on the TV screen go to step 3.
MP3/WMA disc; The MP3/WMA-JPEG choice menu appears on the TV screen. Go to step 2



- 2 Press ▲▼ to select the MP3/WMA then press SELECT/ENTER.**
The MP3/WMA menu appears on the TV screen. Press RETURN to move to the MP3/WMA-JPEG choice menu.

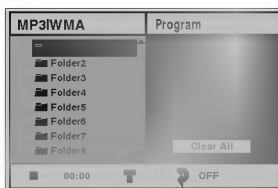

- 3 Press ▲▼ to select a folder, and SELECT/ENTER.**
A list of files in the folder appears.
- 4 Press ▲▼ to select a track then press PLAY or SELECT/ENTER.**
Playback starts.
During playback, the current track's elapsed playing time will appear on the display window and menu. Playback will stop at the end of the disc.
Press TITLE to move to the next page.
Press MENU to move to the previous page.

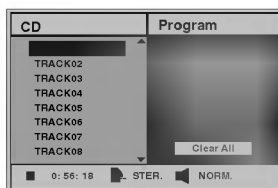

Audio CD menu



MP3/WMA menu



If you are in a file list and want to return to the Folder list, use the ▲▼ to highlight  and press SELECT/ENTER to return to the previous menu screen.

- 5 To stop playback at any other time, press STOP.**



Notes on MP3/WMA Recordings

About MP3

- An MP3 file is audio data compressed by using the MPEG1 audio layer-3 file-coding scheme. We call files that have the “.mp3” file extension “MP3 files”.
- The player can not read an MP3 file that has a file extension other than “.mp3”.

About WMA(Window Media Audio)

- An WMA file is a Microsoft audio compression technology.
- WMA(Windows Media Audio) offers double the audio compression of the MP3 format.

MP3/WMA Disc compatibility with this player is limited as follows:

1. Sampling Frequency / only at 44.1kHz (MP3), 22.05 - 44.1kHz (WMA)
2. Bit rate / within 32 - 320kbps (MP3), 32 - 128kbps (WMA)
3. CD-R physical format should be “ISO 9660”
4. If you record MP3/WMA files using the software which cannot create a FILE SYSTEM, for example “Direct-CD” etc., it is impossible to playback MP3/WMA files. We recommend that you use “Easy-CD Creator”, which creates an ISO9660 file system.
5. A single session disc requires MP3/WMA files in the first track. If there is no MP3/WMA file in the 1st track, it cannot playback MP3/WMA files. If you wish to playback MP3/WMA files, format all the data in the disc or use a new one.
6. File names should be named using 8 letters or less and must incorporate “.mp3” or “.wma” extension e.g. “*****.MP3” or “*****.WMA”.
7. Do not use special letters such as “/ : * ? “ < > ” etc.
8. Total number of files on the disc should be less than 650.

This DVD player requires discs/recordings to meet certain technical standards in order to achieve optimal playback quality. Pre-recorded DVDs are automatically set to these standards. There are many different types of recordable disc formats (including CD-R containing MP3 or WMA files). That require certain pre-existing conditions (see above) to insure compatible playback.



Customers should also note that permission is required in order to download MP3/WMA files and music from the Internet. Our company has no right to grant such permission. Permission should always be sought from the copyright owner.

Operation with Audio and MP3/WMA Disc (Continued)

Pause

- 1 Press PAUSE/STEP during playback.
- 2 To return to playback, press PLAY or press PAUSE/STEP again.











Moving to another Track

- Press SKIP/SCAN  or  briefly during playback to go to the next track or to return to the beginning of the current track.
- Press SKIP/SCAN  twice briefly to step back to the previous track.
- In case of audio CD, to go directly to any track, enter the track number using the numbered buttons (0-9) during playback.

Repeat Track/All/Off

- 1 To repeat the track currently playing, press REPEAT. The Repeat icon and "TRACK" appears on the menu screen.
- 2 To repeat all tracks on a disc, press REPEAT a second time. The Repeat icon and "ALL" appears on the menu screen.
- 3 To cancel Repeat mode, press REPEAT a third time. The Repeat icon and "OFF" appears on the menu screen.

Search

- 1 Press and hold SKIP/SCAN  or  for about two seconds during playback. The player will now go into SEARCH mode.
- 2 Press and hold SKIP/SCAN  or  repeatedly to select the required speed: X2, X4, X8 (backward) or X2, X4, X8 (forward). Search speed and direction are indicated on the menu screen.
- 3 To exit SEARCH mode, press PLAY.

Random

- 1 Press RANDOM during playback or when playback is stopped. The unit automatically begins Random Playback and RANDOM or "RAND." appears on the display window and menu screen.
- 2 To return to normal playback, press RANDOM repeatedly until RANDOM or "RAND." disappears on the display window and menu screen.

Repeat A-B

To repeat a sequence.

- 1 During disc playback, press A-B at your chosen starting point. The Repeat icon and "A * " appears on the menu screen.
- 2 Press A-B again at your chosen end point. The Repeat icon and "A B" appears on the menu screen, and the sequence begins to play repeatedly.
- 3 To exit the sequence and return to normal play, press A-B again. The Repeat icon and "OFF" appears on the menu screen.

3D Surround

This unit can produce a 3D Surround effect, which simulates multi-channel audio playback from two conventional stereo speakers, instead of the five or more speakers normally required to listen to multi-channel audio from a home theater system.

- 1 Press SOUND to select "3D SUR" during playback.
- 2 To turn off the 3D Surround effect, press SOUND again to select "NORM."

Changing the Audio Channel

Press AUDIO repeatedly during playback to hear a different audio channel (STER., LEFT, or RIGHT).

Operation with JPEG Disc

Viewing a JPEG disc

This DVD Player can play discs with JPEG files and Kodak picture CD. Before playing JPEG recordings, read the notes on JPEG Recordings on right.

- 1 Insert a disc and close the tray.**
The MP3/WMA-JPEG choice menu appears on the TV screen.



- 2 Press ▲/▼ to select the JPEG then press SELECT/ENTER.**
The JPEG menu appears on the TV screen.



- 3 Press ▲/▼ to select a folder, and SELECT/ENTER.**
A list of files in the folder appears.
Press RETURN to move to the MP3/WMA-JPEG choice menu.

Tip

If you are in a file list and want to return to the Folder list, use the ▲/▼ buttons on the remote to highlight “..” and press SELECT/ENTER to return to the previous menu screen.

- 4 If you want to view a particular file, press ▲/▼ to highlight a file and press SELECT/ENTER or PLAY.**

Viewing the file proceeding starts.
During viewing a file, press RETURN to move to the previous menu (JPEG menu).
Press TITLE to move to the next page.
Press MENU to move to the previous page.



Tip

There are three viewing Slide Speed options: Fast, Normal, Slow, and Off. Press ◀▶ to highlight the Slide Speed then press ▲/▼ to select the option you want to use, and press SELECT/ENTER.

- 5 To stop viewing at any other time, press STOP.**
The JPEG menu appears.



Moving to another File

Press SKIP/SCAN ◀◀ or ▶▶ once during viewing a picture to advance to the next file or to the previous file.

Still Picture

- Press PAUSE/STEP during slide show.
The player will now go into PAUSE mode.
- To return to the slide show, press PLAY or press PAUSE/STEP again.

To flip the picture

Press ▲/▼ during showing a picture to flip the picture horizontally or a vertically.

To rotate picture

Press ◀▶ during showing a picture to rotate the picture clockwise or counter clockwise.

Notes on JPEG Recordings

- Depending upon the size and number of the JPEG files, it could take a long time for the DVD player to read the disc's contents. If you don't see an on-screen display after several minutes, some of the files are too big — reduce the resolution of the JPEG files to less than 2 mega pixels and burn another disc.
- Total number of files and folders on the disc should be less than 650.
- Some disc may be incompatible due to different recording format or condition of disc.
- When you are using software such as “Easy CD Creator” to burn the jpeg files into the CD-R, ensure that all the selected files have the “.jpg” extensions when copying into the CD layout.
- If the files have “.jpe” or “.jpeg” extensions, please rename them as “.jpg” files.
- File names without “.jpg” extension will not be able to be read by this DVD player. Even though the files are shown as JPEG image files in windows explorer.

Programmed Playback

Programmed Playback with Audio CD and MP3/WMA Disc

The Program function enables you to store your favorite tracks from any disc in the player memory.

Program can contain 30 tracks.

1 Press PROGRAM during playback or in the stop mode to enter the Program Edit mode.

The  mark will appear to the right of the word Program on the right side of the menu screen.

Note

Press PROGRAM to exit the Program Edit mode; the  mark will disappear.

2 Select a track, then press SELECT/ENTER to place the selected track on the Program list.

3 Repeat step 2 to place additional tracks on the Program list.

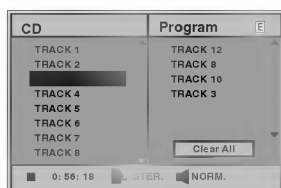

Audio CD menu

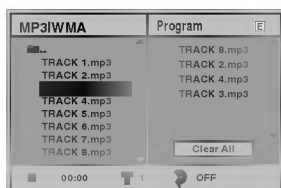

MP3/WMA menu

4 Press .

The programmed track you selected last is highlighted on the program list.

5 Press to select the track you want to start playing.

Press TITLE to move to the next page.
Press MENU to move to the previous page.

6 Press PLAY to start.

Playback begins in the order in which you programmed the tracks and "PROG." appears on the menu screen. Playback stops after all of the tracks on the Program list have played once.

7 To resume normal playback from programmed playback, select a track of CD (or MP3) list and then press SELECT/ENTER.

"PROG." indicator disappears on the menu screen.

Programmed Playback with Video CD

Note

On a Video CD with PBC, you must set PBC to Off on the setup menu to use the Program function. See page 13.

1 Insert Video CD and close the tray.

2 Press PROGRAM while playback is stopped.

The VCD Program menu will appear.

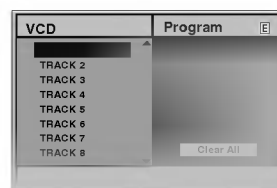

Note

Press RETURN or PROGRAM to exit the Program menu.

3 Follow steps 2-6 of "Programmed Playback with Audio CD and MP3 disc" on left.

4 To resume normal playback from programmed playback, press PROGRAM.

"PROG." indicator disappears in the display window.

Repeat Programmed Tracks

- To repeat the track currently playing, press REPEAT. The Repeat icon and "TRACK" appears on the menu screen.
- To repeat all tracks on the program list, press REPEAT a second time. The Repeat icon and "ALL" appears on the menu screen.
- To cancel Repeat mode, press REPEAT a third time. The Repeat icon and "OFF" appears on the menu screen.

Erasing a Track from Program List

1 Press PROGRAM during playback (Audio CD and MP3 disc only) or in the stop mode to enter the Program Edit mode.

The  mark will appear.

2 Press to move to the Program list.

3 Use to select the track that you wish to erase from the Program list.

4 Press CLEAR.

The track will be erased from the Program list.

Erasing the Complete Program List

1 Follow steps 1-2 of "Erasing a Track from Program List" as above.

2 Use to select "Clear All", then press SELECT/ENTER.

The complete Program for the disc will be erased.

The programs are also cleared when the disc is removed.

Additional Information

Last Condition Memory



This player memorizes the user settings for the last disc that you have viewed. Settings remain in memory even if you remove the disc from the player or switch off the player. If you load a disc that has its settings memorized, the latest stop position is automatically recalled.

Notes

- Settings are stored in memory for use any time.
- This player does not memorize settings of a disc if you switch off the player before commencing to play it.

Screen Saver

The screen saver picture appears when you leave the DVD Player in stop mode for about five minutes. After the Screen Saver has been engaged for about five minutes, the DVD Player will automatically turn itself off.

System Select

You must select the appropriate system mode for your TV system. If NO DISC appears in the display window, press and hold PAUSE on the front panel for more than 5 seconds to be able to select a system (PAL, NTSC, or AUTO).

- When the selected system does not coincide with the system of your TV, normal color picture may not be displayed.

AUTO: Select when DVD player is connected with Multi system TV.

NTSC: Select when DVD player is connected with NTSC-TV.

PAL: Select when DVD player is connected with PAL-TV.

Controlling the TV

Your remote control is capable of operating your DVD player as well as limited functions of LG TV. Follow the instructions below to operate for your LG TV.

1 Before using the remote control, press the **DVD** or **TV** button to select the device to be operated. To switch the remote control mode (to operate a different device), be sure to press the **DVD** or **TV** button first.

2 The **POWER**, **PR./CH.(▼/▲)**, **VOL (◀▶)**, **MUTE** and **TV AV** buttons on remote control are used to operate the LG TV.

Setting Remote Control Codes for LG TV

- This remote control supports two remote control codes for LG TV: Code 1 and Code 2. Code 1 is for LG TV with NTSC or multi system. Code 2 is for LG TV with PAL system.
- When the unit is shipped from the factory, the remote control is set to Code 1.
- To set the remote control to Code 2, hold down both the TV button and the number “2” button on the remote control. (If the batteries in the remote control are replaced while the remote control is set to Code 2, the setting will revert to Code 1.)
- To set the remote control back to Code 1, hold down both the TV button and the number “1” button on the remote control.

Note

If the remote control does not operate your particular TV, try the other code or use the remote control originally supplied with the LG TV. Due to the variety of codes used by manufacturers, OUR COMPANY cannot guarantee that the remote control will operate every model of LG TV.



Troubleshooting

Check the following guide for the possible cause of a problem before contacting service.

Symptom	Cause	Correction
No power.	<ul style="list-style-type: none"> The power cord is disconnected. 	<ul style="list-style-type: none"> Plug the power cord into the wall outlet securely.
The power is on, but the DVD player does not work.	<ul style="list-style-type: none"> No disc is inserted. 	<ul style="list-style-type: none"> Insert a disc. (Check that the DVD or, audio CD indicator in the display window is lit.)
No picture.	<ul style="list-style-type: none"> The TV is not set to receive DVD signal output. 	<ul style="list-style-type: none"> Select the appropriate video input mode on the TV so the picture from the DVD player appears on the TV screen.
	<ul style="list-style-type: none"> The video cable is not connected securely. 	<ul style="list-style-type: none"> Connect the video cable securely.
	<ul style="list-style-type: none"> The connected TV power is turned off. 	<ul style="list-style-type: none"> Turn on the TV.
No sound.	<ul style="list-style-type: none"> The equipment connected with the audio cable is not set to receive DVD signal output. 	<ul style="list-style-type: none"> Select the correct input mode of the audio receiver so you can listen to the sound from the DVD player.
	<ul style="list-style-type: none"> The audio cables are not connected securely. 	<ul style="list-style-type: none"> Connect the audio cable securely.
	<ul style="list-style-type: none"> The power of the equipment connected with the audio cable is turned off. 	<ul style="list-style-type: none"> Turn on the equipment connected with the audio cable.
	<ul style="list-style-type: none"> The Digital Audio Output is set to the wrong position. 	<ul style="list-style-type: none"> Set the Digital Audio Output to the correct position, then turn on the DVD player again by pressing OPERATE.
The playback picture is poor.	<ul style="list-style-type: none"> The disc is dirty. 	<ul style="list-style-type: none"> Clean the disc.
The DVD player does not start playback.	<ul style="list-style-type: none"> No disc is inserted. 	<ul style="list-style-type: none"> Insert a disc. (Check that the DVD, or audio CD indicator in the DVD display is lit.)
	<ul style="list-style-type: none"> An unplayable disc is inserted. 	<ul style="list-style-type: none"> Insert a playable disc. (Check the disc type, color system, and Regional code.)
	<ul style="list-style-type: none"> The disc is placed upside down. 	<ul style="list-style-type: none"> Place the disc with the playback side down.
	<ul style="list-style-type: none"> The disc is not placed within the guide. 	<ul style="list-style-type: none"> Place the disc on the disc tray correctly inside the guide.
	<ul style="list-style-type: none"> The disc is dirty. 	<ul style="list-style-type: none"> Clean the disc.
	<ul style="list-style-type: none"> The Rating level is set. 	<ul style="list-style-type: none"> Cancel the Rating function or change the rating level.
The remote control does not work properly.	<ul style="list-style-type: none"> The remote control is not pointed at the remote sensor of the DVD player. 	<ul style="list-style-type: none"> Point the remote control at the remote sensor of the DVD player.
	<ul style="list-style-type: none"> The remote control is too far from the DVD player. 	<ul style="list-style-type: none"> Operate the remote control within 23 ft (7 m).
	<ul style="list-style-type: none"> There is an obstacle in the path of the remote control and the DVD player. 	<ul style="list-style-type: none"> Remove the obstacle.
	<ul style="list-style-type: none"> The batteries in the remote control are exhausted. 	<ul style="list-style-type: none"> Replace the batteries with new ones.

Speaker Settings

Make the following settings for the built-in 5.1 channel surround decoder.



- 1** Select "5.1 Speaker Setup" using the ▲/▼ buttons on the setup menu.
- 2** While "5.1 Speaker Setup" is selected, press ► button.
- 3** Press ◀▶ buttons to select the desired speaker.
- 4** Adjust options by using ▲/▼/◀▶ buttons.

Speaker selection

Select a speaker that you want to adjust. (Front speakers (Left), Front speakers (Right), Center Speaker, Rear speakers (Left), Rear speakers (Right), or Subwoofer)

N Note

Certain speaker settings are prohibited by the Dolby Digital licensing agreement.

Volume

Press ◀/▶ to adjust the output level of the selected speaker. (-10dB - 0dB)

Size

- Press ◀/▶ to set a mode. (Large, Small or None)
- If you have connected the system to a speaker with a low frequency of 100Hz or below, select "Large."
- If you have connected the system to a speaker without a low frequency of 100Hz or below, select "Small." If you have not connected a subwoofer, always select "Large" for Front speaker (L/R).
- When you do not have a certain speaker connected, select "None."
- Front L/R speaker's size can be set to "Large" or "Small."
- If Front L/R speaker's size is set to "Small," Rear and Center speaker's size can be set to "Small" or "None."
- Subwoofer's size can be set only to "Large" or "None".

Distance

If you connected speakers to your DVD Player, setting the Distance lets the speakers know how far the sound has to travel to reach your set listening point. This allows the sound from each speaker to reach the listener at the same time. (1 ft = 30.48 cm)

Test

Press SELECT/ENTER to test the signals of each speaker. Adjust the volume to match the volume of test signals memorized in the system.

- Front Left (L) → Front Right (R) → Center → Rear Left (L) → Rear Right (R)

Return

Press SELECT/ENTER to return to the previous menu.



Language Code List

Enter the appropriate code number for the initial settings "Disc Audio", "Disc Subtitle" and/or "Disc Menu"
(See page 12).

Code	Language	Code	Language	Code	Language	Code	Language
6566	Abkhazian	7074	Fiji	7678	Lingala	8373	Singhalese
6565	Afar	7073	Finnish	7684	Lithuanian	8375	Slovak
6570	Afrikaans	7082	French	7775	Macedonian	8376	Slovenian
8381	Albanian	7089	Frisian	7771	Malagasy	8379	Somali
6577	Ameharic	7176	Galician	7783	Malay	6983	Spanish
6582	Arabic	7565	Georgian	7776	Malayalam	8385	Sudanese
7289	Armenian	6869	German	7784	Maltese	8387	Swahili
6583	Assamese	6976	Greek	7773	Maori	8386	Swedish
6588	Aymara	7576	Greenlandic	7782	Marathi	8476	Tagalog
6590	Azerbaijani	7178	Guarani	7779	Moldavian	8471	Tajik
6665	Bashkir	7185	Gujarati	7778	Mongolian	8465	Tamil
6985	Basque	7265	Hausa	7865	Nauru	8484	Tatar
6678	Bengali; Bangla	7387	Hebrew	7869	Nepali	8469	Telugu
6890	Bhutani	7273	Hindi	7879	Norwegian	8472	Thai
6672	Bihari	7285	Hungarian	7982	Oriya	6679	Tibetan
6682	Breton	7383	Icelandic	8065	Panjabi	8473	Tigrinya
6671	Bulgarian	7378	Indonesian	8083	Pashto, Pushto	8479	Tonga
7789	Burmese	7365	Interlingua	7065	Persian	8482	Turkish
6669	Byelorussian	7165	Irish	8076	Polish	8475	Turkmen
7577	Cambodian	7384	Italian	8084	Portuguese	8487	Twi
6765	Catalan	7465	Japanese	8185	Quechua	8575	Ukrainian
9072	Chinese	7487	Javanese	8277	Rhaeto-Romance	8582	Urdu
6779	Corsican	7578	Kannada	8279	Rumanian	8590	Uzbek
7282	Croatian	7583	Kashmiri	8285	Russian	8673	Vietnamese
6783	Czech	7575	Kazakh	8377	Samoan	8679	Volapük
6865	Danish	7589	Kirghiz	8365	Sanskrit	6789	Welsh
7876	Dutch	7579	Korean	7168	Scots Gaelic	8779	Wolof
6978	English	7585	Kurdish	8382	Serbian	8872	Xhosa
6979	Esperanto	7679	Laothian	8372	Serbo-Croatian	7473	Yiddish
6984	Estonian	7665	Latin	8378	Shona	8979	Yoruba
7079	Faroese	7686	Latvian, Lettish	8368	Sindhi	9085	Zulu

Country Code List

Enter the appropriate code number for the initial setting "Country Code" (See page 14).

Code	Country	Code	Country	Code	Country	Code	Country
AD	Andorra	ER	Eritrea	LC	Saint Lucia	SC	Seychelles
AE	United Arab Emirates	ES	Spain	LI	Liechtenstein	SD	Sudan
AF	Afghanistan	ET	Ethiopia	LK	Sri Lanka	SE	Sweden
AG	Antigua and Barbuda	FI	Finland	LR	Liberia	SG	Singapore
AI	Anguilla	FJ	Fiji	LS	Lesotho	SH	Saint Helena
AL	Albania	FK	Falkland Islands	LT	Lithuania	SI	Slovenia
AM	Armenia	FM	Micronesia	LU	Luxembourg	SJ	Svalbard and Jan Mayen Islands
AN	Netherlands Antilles	FO	Faroe Islands	LV	Latvia	SK	Slovak Republic
AO	Angola	FR	France	LY	Libya	SL	Sierra Leone
AQ	Antarctica	FX	France (European Territory)	MA	Morocco	SM	San Marino
AR	Argentina	GA	Gabon	MC	Monaco	SN	Senegal
AS	American Samoa	GB	Great Britain	MD	Moldavia	SO	Somalia
AT	Austria	GD	Grenada	MG	Madagascar	SR	Suriname
AU	Australia	GE	Georgia	MH	Marshall Islands	ST	Saint Tome and Principe
AW	Aruba	GF	French Guyana	MK	Macedonia	SU	Former USSR
AZ	Azerbaijan	GH	Ghana	ML	Mali	SV	El Salvador
BA	Bosnia-Herzegovina	GI	Gibraltar	MM	Myanmar	SY	Syria
BB	Barbados	GL	Greenland	MN	Mongolia	SZ	Swaziland
BD	Bangladesh	GM	Gambia	MO	Macau	TC	Turks and Caicos Islands
BE	Belgium	GN	Guinea	MP	Northern Mariana Islands	TD	Chad
BF	Burkina Faso	GP	Guadeloupe (French)	MQ	Martinique (French)	TF	French Southern Territories
BG	Bulgaria	GQ	Equatorial Guinea	MR	Mauritania	TG	Togo
BH	Bahrain	GR	Greece	MS	Montserrat	TH	Thailand
BI	Burundi	GS	S. Georgia & S. Sandwich Isls.	MT	Malta	TJ	Tadjikistan
BJ	Benin	GT	Guatemala	MU	Mauritius	TK	Tokelau
BM	Bermuda	GU	Guam (USA)	MV	Maldives	TM	Turkmenistan
BN	Brunei Darussalam	GW	Guinea Bissau	MW	Malawi	TN	Tunisia
BO	Bolivia	GY	Guyana	MX	Mexico	TO	Tonga
BR	Brazil	HK	Hong Kong	MY	Malaysia	TP	East Timor
BS	Bahamas	HM	Heard and McDonald Islands	MZ	Mozambique	TR	Turkey
BT	Bhutan	HN	Honduras	NA	Namibia	TT	Trinidad and Tobago
BV	Bouvet Island	HR	Croatia	NC	New Caledonia (French)	TV	Tuvalu
BW	Botswana	HT	Haiti	NE	Niger	TW	Taiwan
BY	Belarus	HU	Hungary	NF	Norfolk Island	TZ	Tanzania
BZ	Belize	ID	Indonesia	NG	Nigeria	UA	Ukraine
CA	Canada	IE	Ireland	NI	Nicaragua	UG	Uganda
CC	Cocos (Keeling) Islands	IL	Israel	NL	Netherlands	UK	United Kingdom
CF	Central African Republic	IN	India	NO	Norway	UM	USA Minor Outlying Islands
CG	Congo	IO	British Indian Ocean Territory	NP	Nepal	US	United States
CH	Switzerland	IQ	Iraq	NR	Nauru	UY	Uruguay
CI	Ivory Coast	IR	Iran	NU	Niue	UZ	Uzbekistan
CK	Cook Islands	IS	Iceland	NZ	New Zealand	VA	Vatican City State
CL	Chile	IT	Italy	OM	Oman	VC	Saint Vincent & Grenadines
CM	Cameroon	JM	Jamaica	PA	Panama	VE	Venezuela
CN	China	JO	Jordan	PE	Peru	VG	Virgin Islands (British)
CO	Colombia	JP	Japan	PF	Polynesia (French)	VI	Virgin Islands (USA)
CR	Costa Rica	KE	Kenya	PG	Papua New Guinea	VN	Vietnam
CS	Former Czechoslovakia	KG	Kyrgyzstan	PH	Philippines	VU	Vanuatu
CU	Cuba	KH	Cambodia	PK	Pakistan	WF	Wallis and Futuna Islands
CV	Cape Verde	KI	Kiribati	PL	Poland	WS	Samoa
CX	Christmas Island	KM	Comoros	PM	Saint Pierre and Miquelon	YE	Yemen
CY	Cyprus	KN	Saint Kitts & Nevis Anguilla	PN	Pitcairn Island	YT	Mayotte
CZ	Czech Republic	KP	North Korea	PR	Puerto Rico	YU	Yugoslavia
DE	Germany	KR	South Korea	PT	Portugal	ZA	South Africa
DJ	Djibouti	KW	Kuwait	PW	Palau	ZM	Zambia
DK	Denmark	KY	Cayman Islands	PY	Paraguay	ZR	Zaire
DM	Dominica	KZ	Kazakhstan	QA	Qatar	ZW	Zimbabwe
DO	Dominican Republic	LA	Laos	RE	Reunion (French)		
DZ	Algeria	LB	Lebanon	RO	Romania		
EC	Ecuador			RU	Russian Federation		
EE	Estonia			RW	Rwanda		
EG	Egypt			SA	Saudi Arabia		
EH	Western Sahara			SB	Solomon Islands		

Specifications

General

Power requirements	AC 110-240V , 50/60 Hz
Power consumption	14W
Dimensions (approx.)	430 X 48 X 242 mm (w x h x d)
Mass (approx.)	2.34 kg
Operating temperature	5°C to 35°C (41°F to 104°F)
Operating humidity	5 % to 90 %

System

Laser	Semiconductor laser, wavelength 650 nm
Signal system	PAL/NTSC
Frequency response	DVD (PCM 96 kHz): 8 Hz to 44 kHz DVD (PCM 48 kHz): 8 Hz to 22 kHz CD: 8 Hz to 20 kHz
Signal-to-noise ratio	More than 100dB (ANALOG OUT connectors only)
Harmonic distortion	Less than 0.008%
Dynamic range	More than 100 dB (DVD) More than 95 dB (CD)

Outputs

VIDEO OUT	1 Vp-p 75 Ω , sync negative, RCA jack x 1
S-VIDEO OUT	(Y) 1.0 V (p-p), 75 Ω , negative sync, Mini DIN 4-pin x 1 (C) 0.3 V (p-p) 75 Ω
COMPONENT VIDEO OUT	(Y) 1.0 V (p-p), 75 Ω , negative sync, RCA jack x 1 (Pb)/(Pr) 0.7 V (p-p), 75 Ω , RCA jack x 2
Audio output (digital audio)	0.5 V (p-p), 75 Ω , RCA jack x 1
Audio output (optical audio)	5 V (p-p), 75 Ω , Optical connector x 1
Audio output (analog audio)	2.0 Vrms (1 KHz, 0 dB), 600 Ω , RCA jack (L, R) x 1

Accessory

S-Video cable1
Video cable1
Audio cable1
Remote control1
Batteries2

- Design and specifications are subject to change without notice.

Manufactured under license from Dolby Laboratories. Dolby and the double-D symbol are trademarks of Dolby Laboratories. Confidential unpublished works. Copyright 1992-1997 Dolby Laboratories. All rights reserved.

DTS and DTS Digital Out are registered trademarks of Digital Theater Systems, Inc.





P/NO : 3834RS0053H