



ENGLISH

GPRS Phone

USER'S MANUAL

MODEL: G5300i

Please read this manual carefully
before operating your set. Retain it for
future reference.



P/N : MMBB0090315

Revision 1.1
PRINTED IN KOREA

ENGLISH



GPRS Phone

USER'S MANUAL

MODEL: G5300i

Please read this manual carefully
before operating your set.
Retain it for future reference.

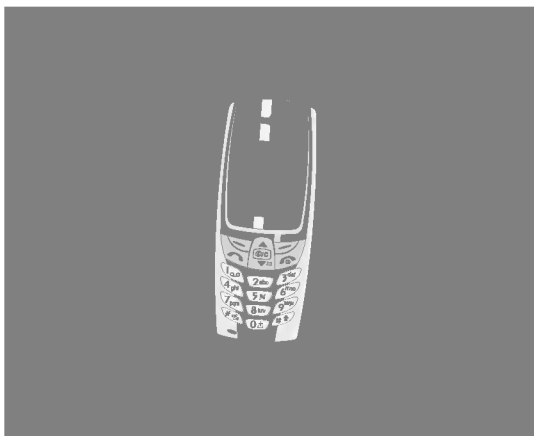

For Your Safety

All radio transmitters carry risks of interference with electronics in close proximity.



GSM Phones must be switched off at all times in an aircraft.



Do not activate near petrol stations, fuel depots, chemical plants or blasting operations.



Switch off the phone in any area where you are required by special regulations. For example, the phone is not allowed to be used in hospital because pacemakers and hearing aids can be affected.



Minor interference may affect TVs, radios, PCs, etc.



Do not hold the phone in your hand while driving.



Do not dismantle phone or battery.



Keep the phone in a safe place out of children's reach since it contains the detachable small parts and create a choking hazard.



Do not touch the charger with wet hands.



For your safety, use ONLY specified ORIGINAL batteries and chargers.

Please note:



Unusable batteries should be disposed of in accordance with relevant legislation.



Only use ORIGINAL accessories to avoid damage to your phone.



Emergency call may not be available under all cellular networks. Therefore, you should never depend solely on the phone for essential communications such as medical emergencies.

Important Information

This user's guide contains important information on the use and operation of this phone. Please read all the information carefully for optimal performance and to prevent any damage to or misuse of the phone. Any changes or modifications not expressly approved in this user's guide could void your warranty for this equipment.

Contents

Overview

Part of the Phone	10
• Front of the Phone	10
• Rear of the Phone	11
Key Description	12
• Alphanumeric Keys	14

Display Information

Display Information	15
• On-Screen Icons	15

Getting Started

Installation	17
• Inserting the SIM Card	17
• Installing the Battery	18
• Charging the Battery	19
• Disconnecting the charger	20
Powering On Sequence	21
• To get started with the phone	21
• To turn off the phone	21
Access Codes	22
• PIN code (4 to 8 digits)	22
• PIN2 code (4 to 8 digits)	22
• PUK code (4 to 8 digits)	22
• PUK2 code (4 to 8 digits)	23
• Security code (4 to 8 digits)	23

Accessing the Menu

Phonebook	24
Menu Tree	25
Messages [Menu 1]	27
• Write short message [Menu 1-1]	27
• Write multimedia message [Menu 1-2]	29
• Inbox [Menu 1-3]	34
• Outbox [Menu 1-4]	36
• Voice mail [Menu 1-5]	37
• Info service [Menu 1-6]	38
• Templates [Menu 1-7]	39
• Settings [Menu 1-8]	40
Call Register [Menu 2]	43
• Missed calls [Menu 2-1]	43
• Received calls [Menu 2-2]	43
• Dialed calls [Menu 2-3]	43
• All calls list [Menu 2-4]	43
• Delete recent calls [Menu 2-5]	43
• Call charge [Menu 2-6]	44
• GPRS information [Menu 2-7]	46
Profiles [Menu 3]	47
• Vibrate only [Menu 3-1]	47
• Quiet [Menu 3-2]	47
• General [Menu 3-3]	47
• Loud [Menu 3-4]	47
• Headset [Menu 3-5]	47
• Car [Menu 3-6]	48

Settings [Menu 4]	50
• Alarm clock [Menu 4-1]	50
• Date & Time [Menu 4-2]	50
• Phone settings [Menu 4-3]	51
• Call settings [Menu 4-4]	53
• Security settings [Menu 4-5]	57
• Network settings [Menu 4-6]	60
• Reset settings [Menu 4-7]	61
Organizer [Menu 5]	62
• Scheduler [Menu 5-1]	62
• Phone book [Menu 5-2]	63
Fun & Tools [Menu 6]	72
• Calculator [Menu 6-1]	72
• My folder [Menu 6-2]	72
• Game [Menu 6-3]	73
• Unit converter [Menu 6-4]	74
• World time [Menu 6-5]	74
WAP services [Menu 7]	75
• Home [Menu 7-1]	75
• Bookmarks [Menu 7-2]	75
• Push messages [menu 7-3]	75
• Profiles [Menu 7-4]	76
• Go to URL [Menu 7-5]	78
• Cache settings [Menu 7-6]	79
• Security certifications [Menu 7-7]	79
• Reset profiles [Menu 7-8]	79

Java [Menu 8]	80
• Applications [Menu 8-1]	80
• Memory status [Menu 8-2]	81
• Download [Menu 8-3]	81
Internet On-line menu	82

Additional Functions

How to Use Data and Fax call	83
• Sending Data or Fax Calls	83
• Receiving Data or Fax Calls	83
In call Menu	85
1. During a call	85
2. Multiparty or Conference Calls	87
Accessories	90
Care and Maintenance	92
Technical Data	94

Front of the Phone

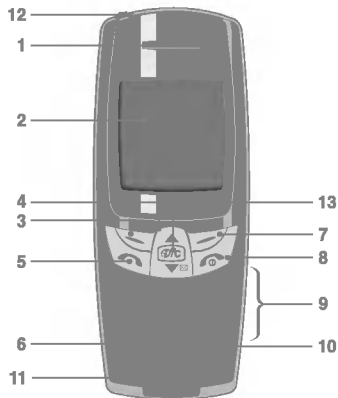

- | | |
|-------------------|-----------------------------|
| 1 Earpiece | 8 END/PWR keys |
| 2 Display Screen | 9 Numeric Keys |
| 3 Soft Left Key | 10 Hash Key |
| 4 Navigation Keys | 11 Microphone |
| 5 Send Key | 12 Ear Microphone Connector |
| 6 Star Key | 13 WAP Hotkey/
Clear key |
| 7 Soft Right Key | |



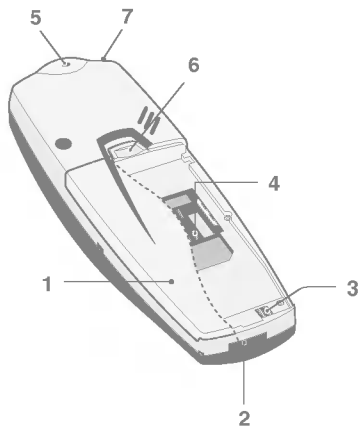







Rear of the Phone





- 1 Battery
- 2 Cable Connector/
Battery Charging Connector/
Hands-Free Car kit Connector
- 3 Battery Terminals
- 4 SIM Card Socket
- 5 Handstrap Hole
- 6 Battery Lock
- 7 Ear Microphone Connector

The following shows key components of the phone.

Keypad Description

Key	
	<p>Soft Left Key / Soft Right Key Each of these keys performs the function indicated by the text on the display immediately above it.</p>
	<p>WAP Hotkey / Clear key Used to connect to WAP directly by pressing this key. Used to delete character(s).</p> <p>Navigation Keys Used to scroll through name, phone numbers, menus or setting options.</p>
	Used to enter Message menu directly.
	Used to scroll through names, phone numbers.
	<p>Send Key You can dial a phone number and answer a call. If you press this key without entering a number, your phone shows the most recently dialed number.</p>
	<p>Numeric Keys These keys are used mainly to dial in standby mode and enter numbers or characters in editing mode. When you press these keys for a long time.</p> <ul style="list-style-type: none"> Used to call your voicemail box by . Used to call for international call by . Used to call Speed dials by from  to .

Key	
	Used to enter the vibration mode by pressing this key for a long time.
	Used to call by voice dial with long pressing this key. This key is also used as Ear mic. hook key when connecting Ear mic.
	END/PWR Key Used to end or reject a call. This key is also used as Power Key. Pressing and holding this key for a few seconds.

Alphanumeric Keys

The alphabet and numerical keypad mapping relation are listed as the following table.















Key	
	., / ? ! - : ' " 1
	A B C 2 Ä Å Ã Ä Å Æ Ç a b c ä å á â ã ä å ç
	D E F 3 Ě ě Ě ě D e f ě ě ě ě
	G H I 4 Ĩ ĩ Ĩ ĩ Ğ ğ h i ĩ ĩ ğ
	J K L 5 j k l
	M N O 6 Ñ Ñ Ñ Ñ Ñ Ñ Ñ Ñ m n o ñ ñ ñ ñ ñ ñ ñ
	P Q R S 7 Ş ş p q r s β ş
	T U V 8 Ũ ù Ũ ù Ũ ù Ũ ù t u v ù ù ù ù
	W X Y Z 9 w x y z
	0 [Space Key]

Display Information

Display Information





The screen displays several icons the following describe each of them you may see on the phone.

On-Screen Icons







Icon/Indicator	
	Tells you the strength of the network signal.
	Call is connected.
	You can use GPRS service.
	Shows that you are using a roaming service.
	Line 1/2 is in use for outgoing calls – If you subscribe to the Two Line Service.
	The alarm has been set and is on.
	Tells you the status of the battery.
	You have received a text message.
	You have received a voice message.
	You have received an E-mail.
	You can view your schedule.
	All audible signals are turned off.
	General menu in profile.
	Loud menu in profile.
	Quiet menu in profile.

Display Information

Display Information

Icon/Indicator	
	Headset menu in profile.
	Car menu in profile.
	You can divert a call.
	You can use Push message service through WAP.

Top Menu Icons

Icon	
	Messages
	Call Register
	Profiles
	Settings
	Organizer
	Fun & Tools
	Wap services
	Java
	SIM Service

1 Inserting the SIM Card

Locate the SIM card socket in the back of the phone.
Follow the steps below to install the SIM card.

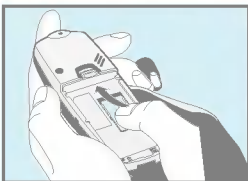

1. Remove the battery if attached.
2. Slide the SIM card into the slot, under the silvery holders, with the golden connectors facing down and the cut corner to the right.

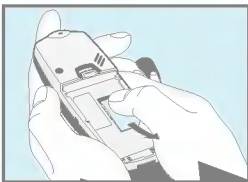

3. If you need to remove the SIM card, press the upper part of SIM card with the thumb, then carefully slide it out of the SIM card slot.

● Notice

- Before installing always make sure that the phone is switched off and remove the battery.
- The metal contact of the SIM card can be easily damaged by scratches. Pay special attention to the SIM card when you handle and install. Follow the instructions supplied with the SIM card.

② Installing the Battery

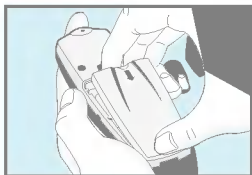

1. Place the battery on the back of the phone.

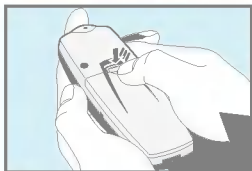

2. Push it until you hear a click.

3 Charging the Battery

To connect the travel adapter to the phone, you must have installed the battery.

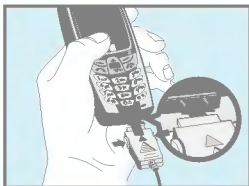

1. Insert one end of the travel adapter into the bottom of the phone.

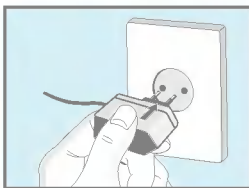

2. Connect the other end of the travel adapter to an AC wall outlet.
Use only the included packing charger.



● Warning

- Do not force the connector as this may damage the phone and/or the travel adapter.

4 Disconnecting the charger



Disconnect the travel adapter from the phone by pressing its side buttons.

● Notice

- The battery delivered with your phone has to be fully charged before using it.
- Do not remove your battery or the SIM card while charging.
- “Charging” is displayed on the screen after connecting the travel adapter. Only if the battery is totally empty, Back light is on without displaying “Charging”. Please note in this case, it may require a longer initial charging time before displaying “Charging” on the screen of the phone. The charging time depends on the charger and the battery used.
- The moving bars of battery icon will stop after charging completely.

① To get started with the phone



1. Press and hold  key until you hear a tone.
2. Depending on setting **PIN code request**, you can enter PIN code or not.
3. If your phone connects to a network, the network name will be displayed shortly.

② To turn off the phone

In standby mode, press and hold  key until you hear a tone.

You can use the access codes described in this section to avoid unauthorised use of your phone. The access codes (except PUK1 and PUK2 codes) can be changed by using [Menu 4-5-6].

PIN code (4 to 8 digits)

The PIN (Personal Identification Number) code protects your SIM card against unauthorised use. The PIN code is usually supplied with the SIM card. When **PIN code request** is set **Enable**, your phone will request the PIN code every time it is switched on. On the contrary, when **PIN code request** is set **Disable**, your phone connects to the network directly without the request PIN code.

PIN2 code (4 to 8 digits)

The PIN2 code, supplied with some SIM cards, is required to access some functions such as Advice of call charge, Fixed Dial number. These functions are only available if supported by your SIM card.

PUK code (4 to 8 digits)

The PUK(PIN Unblocking Key) code is required to change a blocked PIN code. The PUK code may be supplied with the SIM card. If not, contact your local service provider for the code. If you lose the code, also contact your service provider.

PUK2 code (4 to 8 digits)

The PUK2 code, supplied with some SIM cards, is required to change a blocked PIN2 code. If you lose the code, also contact your service provider.

Security code (4 to 8 digits)

The security code protects the unauthorised use of your phone. It is usually supplied with the phone. This code is required to delete all phone entries and to activate “Reset settings” menu. The default number is “0000”.

Phonebook

Accessing the Menu



To select a menu in phonebook, press [Names] in standby mode and then scroll to a desired item.

1	Search	Allows you to search for a specific name, number.
2	Add new	Allows you to add new names and numbers.
3	Speed dials	Allows you to assign up to 8 (2 nd - 9 th) one-touch dial allocations.
4	Voice list	Allows you to list phone numbers which is attached voice.
5	Caller groups	Allows you to show group list.
6	Copy all	Allows you to copy entries from your Phone memory to SIM card or from SIM card to Phone memory.
7	Delete all	Allows you to erase all the data in either your phonebook or the SIM card to the phone memory.
8	Settings	Allows you to set the memory and to search item by Variable, name and number.
9	Information	Allows you to check the status of memory, SDN (Service Dial Number), and Own number list.



1 Messages

- 1 Write short message
- 2 Write multimedia message
- 3 Inbox
- 4 Outbox
- 5 Voice mail
- 6 Info service
- 7 Templates
- 8 Settings



2 Call Register

- 1 Missed calls
- 2 Received calls
- 3 Dialed calls
- 4 All calls list
- 5 Delete recent calls
- 6 Call charge
- 7 GPRS information



3 Profiles

- 1 Vibrate only
- 2 Quiet
- 3 General
- 4 Loud
- 5 Headset
- 6 Car



4 Settings

- 1 Alarm clock
- 2 Date & Time
- 3 Phone settings
- 4 Call settings
- 5 Security settings
- 6 Network settings
- 7 Reset settings



5 Organizer

- 1 Scheduler
- 2 Phone book



6 Fun & Tools

- 1 Calculator
- 2 My folder
- 3 Game
- 4 Unit converter
- 5 World time



7 WAP services

- 1 Home
- 2 Bookmarks
- 3 Push messages
- 4 Profiles
- 5 Go to URL
- 6 Cache settings
- 7 Security certifications
- 8 Reset profiles



8 Java

- 1 Applications
- 2 Memory status
- 3 Download



9 SIM Service

This menu depends on SIM and the network services.



This menu includes functions related to SMS (Short Message Service), MMS (Multimedia Message Service), voice mail, as well as the network's service messages.

Write short message [Menu 1-1]

You can write and edit text messages, checking the number of characters.

1. Enter **Messages** then select **Write short message**.
2. To write a message, use T9 text. For details, see How to use T9 (Page 31).
3. Press [Insert] to attach the followings.
4. When you finish writing, press [Options].

Insert

- **Symbol**

You can add special characters.

- **Picture**

You can insert the **Default** pictures or pictures in **My folder** that are available for short messages.

- **Sound**

You can insert sounds that are available for short messages.

- **Text templates**

You can use **Text templates** already set in the phone.

- **Phone book**

You can add phone numbers or e-mail addresses in **Phone book**.





- **Business card**

You can add your contact information to the message.

Options

- **Send**

Sends text messages.

1. Enter numbers of recipient.
2. Press  key to add more recipients.
3. You can add phone numbers in the phone book.
4. Press  after entering numbers.

- **Save**

Stores messages in Outbox.

- **Font**

You can select **Size** and **Style** of fonts.

- **Colour**

You can select **Colour** of foreground and background.

- **Alignment**

You can make the message contents aligned **Right**, **Centre** or **Left**.

- **Add T9 dictionary**

You can add your own word. This menu can be shown only when edit mode is **Predictive (T9Abc/T9abc/T9ABC)**.



- **T9 languages**

Select a T9 input mode.

- **Exit**

If you press **Exit** while writing a message, you can end the writing message and back to the Message menu. The message you have written is not saved.

Write multimedia message [Menu 1-2]

You can write and edit multimedia messages, checking message size.

1. Enter the Messages menu by pressing  [Select].
2. If you want to write a new message, select **Write multimedia message**.
3. You can create a new message or choose one of the multimedia message templates already made.
4. Press **Insert** to add **Symbol, Picture, Sound, Text templates, Phonebook** or **Business card**.

Options

- **Preview**

You can preview multimedia messages you wrote.

- **Send**

You can send multimedia messages to multiple recipients, prioritise your message, and make it sent later as well.

- **Save**

You can save multimedia messages in the outbox or as templates.



- **Add slide**

You can add a slide before or after current slide.

- **Move to slide**

You can move to previous or next slide.

- **Delete slide**

You can delete current slides.

- **Set slide format**

- **Set timer**

You can set timer for slide, text, picture and sound.

- **Swap text and picture**

You can switch the position of picture and text of the message.

- **Remove media**

You can remove pictures or sounds in the slide. This option can be shown only when any media exists.

- **Add T9 dictionary**

You can add your own word. This menu can be shown only when edit mode is **Predictive (T9Abc/T9abc/T9ABC)**.

- **T9 languages**

Select a T9 input mode.

- **Exit**

You can back to the **Message** menu.





How to Use T9

T9 allows you to input text quickly.

In T9, you only need to press the key with the corresponding letter once. This is based on a built-in dictionary to which you can also add new words.

• Writing words by using T9.

1. Start writing a word by using the keys  to .
Press each key only once for one letter.
To write for instance 'Girl'.

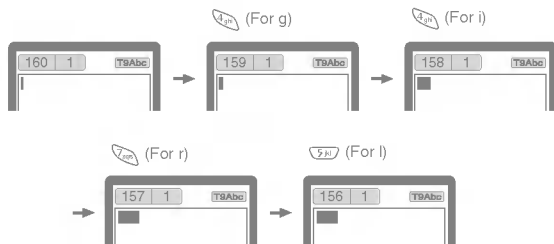



The word changes after each keystroke. Therefore you shouldn't pay too much attention to how the word appears on the display until you have pressed all the appropriate keys.



To delete a character to the left, press .

To insert several numbers, hold  down and key in the numbers.



If you hold  down, you can change the type of language. (You can also use options.)

Also, the phone supports three modes: **Predictive** (T9Abc, T9ABC, T9abc), **Multitap** (ABC, abc), **Numeric** (123). If you want to change a mode, press  key.

Alternatively : Press  key and select insert symbols. Select the desired character and press **Select**.

2. When you have finished writing a word, check whether the word is correct.

If the word is correct : Press  and write the next word.

If the word is not correct : Search by ,  (**Previous** and **Next word**).

Alternatively : If there is no word you want you can add your own word. Press  [Options] in the Predictive edit mode. Select Add T9 dictionary Menu. You can see the following.

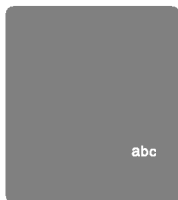

Input your
word

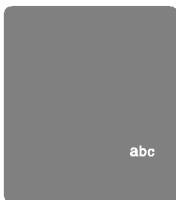

3. To insert a punctuation mark, press  repeatedly until the desired mark appears.

● **T9 languages**



- You can select T9 Languages by selecting Menu. In T9 mode, you can also select T9 Off menu. (Default is T9 On)



Inbox [Menu 1-3]

You will be alerted when you have received messages. They will be stored in Inbox.

In Inbox, you can identify each message by icons. For detail, see the icon directive.

- **Icon directive**
 - [] Multimedia message
 - [] Short message
 - [] SIM message
 - [] Read
 - [] Notified multimedia message

If the phone shows 'No space for SIM message', you have to delete any SIM messages from inbox or outbox. If the phone displays 'No space for message', you can make space of each repository as deleting messages, media and applications.

* **SIM message**

SIM message means the message exceptionally stored in SIM card.

For notified multimedia message, you have to wait for downloading and processing of the message. For notification setting, see [Menu 1-8-2] for detail.

To read a message, select one of the messages by pressing .

Reply

You can reply to the sender.



Forward

You can forward the selected message to another party.

Return call

You can call back to the sender.

Delete

You can delete the current message.

Extract

You can extract picture, sound and text. They will be saved in My folder or Phonebook.

View information

You can view information about received messages; Sender's address, Subject (only for Multimedia message), Message date & time, Message type, Message size.

Replay (applicable to Multimedia message only)

You can replay multimedia messages.



* Receive (In case of notification message)

If **Multimedia message** is set to **Auto download off**, you can get only Notification. To receive a message, you need to select [Receive]. Although **Multimedia message** is set to **Auto download on**, on the network condition or other reasons, you can get notification message.



Outbox [Menu 1-4]

When you have sent a message, you can see the sent message list including delivery report.

- **Icon directive**
 - [] Sent
 - [] Unsent
 - [] Delivery confirmed

* **When you use the message which is already sent**

Edit

You can edit the selected message.

Send

The selected message is to be sent.

Delete

The selected message is deleted.

View information

Shows whether the message was sent, unsent or delivered successfully.



Voice mail [Menu 1-5]

Listen to voice mail

You can listen to voice mail.

Voicemail centre

You can get the voicemail if this feature is supported by the network service provider. When new voicemail is arrived, the symbol will be displayed on the screen. Please check with your network service provider for details of their service in order to configure the handset accordingly.

1. Hold down  key in standby mode.
2. You can check the following submenus.

- **Home**

The number dialed on the home network to listen to voicemail.

- **Roam**

The number dialed when other networks to listen to voicemail.





Info service [Menu 1-6]

(Dependent to network and subscription)

Cell Broadcast messages (CB Message) are text messages by the network to GSM phone users. They provide general information such as weather reports, traffic news, taxis, pharmacies, and stock prices. Each type of information has the number; therefore, you can contact service provider. When you receive CB message, you can read it following sequence:

Read

1. When you receive CB message, it will be displayed on the screen. You can read the message by scrolling  , .
2. After reading the message, press  to return to the standby mode. In addition, you can save it until another message is reached.

Receive

Allows you to receive Cell broadcast messages.

Alert

Allows you to alert by beep when you receive Cell broadcast messages.

Languages

You can select the language you want. Then, the cell broadcast message will be shown in the language that you selected.



Topics (Dependent to network and subscription)

- **Add new**

You can add the CB message category in the Phone memory with its nickname.

- **View list**

You can see the CB message category which you added. If you press [Options], you can edit and delete CB message category which you added.

- **Active list**

You can select the CB message category in the active list by pressing [On/Off].

Templates [Menu 1-7]

You can see 11 predefined messages in the list and save 6 templates before you edit. You can also change them. The others are <Empty>.

Text

Allows you to edit predefined messages.



Multimedia

Allows you to edit predefined Multimedia messages.

You can use the following option for **Text** and **Multimedia**.

Edit : You can edit multimedia templates.

Add new : Allows you to add new multimedia templates.

Write message : You can write multimedia messages using multimedia templates.

Delete : You can delete multimedia templates.

Business card

Settings [Menu 1-8]

Short message

- **Message types**

Text, Voice, Fax, Natl. paging, X.400, E-mail, ERMES

Usually, the type of message is set to **Text**. You can convert your text into alternative formats. Contact your service provider for the availability of this function.

- **Validity period**

This network service allows you to set how long your text messages will be stored at the message centre.



- **Delivery report**

If you set **Yes** in this menu, you can check whether your message is sent successfully or not.

- **Reply via same service centre**

When a message is sent, it allows the person to whom you sent the message to reply and charges the cost of the reply to your telephone bill.

- **SMS centre**

If you want to send the text message, you can get the address of SMS centre through this menu.

Multimedia message

- **Validity period**

This network service allows you to set how long your text messages will be stored at the message centre.

- **Delivery report**

If you set **Yes** in this menu, you can check whether your message is sent successfully or not.

- **Auto download**

If you select 'on', you receive multimedia messages automatically.

If you select 'off', you receive only notification message in inbox and then you can check this notification.



- **Network settings**

If you select multimedia message server, you can set IP address for multimedia message server.

- **Permitted message types**

Personal : Personal message.

Advertisement : Commercial message.

Information : Necessary information.

Memory status

You can check how many free and in-use are in the SIM memory or the Phone memory.



Missed calls [Menu 2-1]

This menu shows recently missed numbers. You can call by this number, also save and view date and time this menu as well as writing messages.

Received calls [Menu 2-2]

This menu shows recently received numbers. You can call by this number, also save and view date and time, as well as writing messages.

Dialled calls [Menu 2-3]

This menu shows recently dialed numbers. You can call by this number, also save and view date and time, as well as writing messages.

All calls list [Menu 2-4]

You can save the phone number and check the date and time for a call. Moreover, you can call back to the other party, as well as writing messages.

Delete recent calls [Menu 2-5]

You can delete the all call records.



Call charge [Menu 2-6]

Within these submenus, you can view the duration and the call cost of your calls.

Call duration

This function allows you to view the duration of your Last Call, All Calls, Received calls and Dialed calls in hours, minutes and seconds. You can also reset the call timers.

Show call costs

This function allows you to check the cost of your last call, all calls, remaining and reset the costs. To reset the cost, you need the PIN2 code.

Note

- The actual call cost may be different depending on network features, billing, and tax.



Settings [SIM Dependent]

- **Set tariff**

You can set the currency type and the unit price. Contact your services providers to obtain charging unit prices. To select the currency or unit in this menu, you need the PIN2 code.

- **Set credit**

This network service allows you to limit the costs of your calls by selected charging units. If you select **Read**, the number of remaining unit is shown. If you select **Change**, you can change your charge limit.

● **Note**

- When all units have been used, no calls can be made except emergency calls. Depending on SIM card, you need the PIN2 code to set a call cost limit.

- **Auto display**

This network service allows you to see automatically cost of your last call. If you select **Yes** in **Auto display** menu, you can see the last cost when the call is released.



GPRS information [Menu 2-7]

You can check the amount of data transferred over the network through GPRS. In addition, you can also view how much time you are online.

Call duration

You can check the duration of GPRS call. You can also reset the call timers.

- **Last call**
- **All calls**
- **Reset**

Data volume

You can check the data volume.

- **Sent**
- **Received**
- **All**
- **Reset all**



In this menu, you can adjust and customize the phone tones for different events, environments and caller's group.

Note

- When your phone is connected to the Handsfree kit, it'll be automatically set to the Car profiles menu and when your phone is connected to the Earmic, it'll be automatically set to Headset profiles menu then each submenu related to them will be displayed automatically.

Vibrate only [Menu 3-1]

You can adjust the profile as Vibration if you need vibration mode.

Quiet [Menu 3-2]

You can adjust the profile as Quiet if you are in quiet place.

General [Menu 3-3]

You can adjust the profile as General.

Loud [Menu 3-4]

You can adjust the profile as Loud if you are in a noisy environment.

Headset [Menu 3-5]

You can adjust the Profiles as Headset when you put on a headset.



Car [Menu 3-6]

You can adjust the Profiles as Car when you activate Handsfree Kit.

A Group of Profiles submenus

Profiles menu have the submenus as shown below.

Incoming alert type

Allows to alert for the incoming call for adjusting environment.

Ring tone

Allows to set the ringing tone for adjusting environment.

Ring volume

Allows to set the ring volume for adjusting environment.

Message alert type

Allows to alert when receiving a message for adjusting environment:
Ring once, Vibrate, Silent.

Key/Effect volume

Allows to set the Key volume and effect volume for adjusting environment.

Keypad tone

Allows to set the keypad tone for adjusting environment.



Auto answer

Allows to set to answer automatically for adjusting environment. Please note that only Car and Headset has this sub menu so that you can activate this function.

- **Off**

Even though your phone is ringing, your phone will not answer automatically.

- **After 5 secs**

After 5 seconds your phone will answer automatically.

- **After 10 secs**

After 10 seconds your phone will answer automatically.

● Note

- If you set the Handsfree kit to the phone, you can't activate the vibration related with Incoming alert or Message alert menu. Therefore, in Handsfree menu, you can view the following submenus;
 - **Incoming alert** : Ring, Silent
 - **Message alert** : Ring Once, Silent



You can set the following menus for your convenience and preferences.

Alarm clock [Menu 4-1]

You can set the alarm to go off at a specified time.

1. Select **On** and enter the alarm time you want.
2. Select the repeat period: **Once, Daily, Weekly, Monthly.**
3. Select the alarm tone you want and press [OK].
4. Edit the alarm name and press [OK].
5. If you set **Alarm clock** to **Power off alarm**, the alarm goes off at a specified time despite the phone is switched off.

Date & Time [Menu 4-2]

You can set functions relating to the date and time.

Date

- **Set date**

You can set the date of your phone.

- **Date format**

You can set the **Date format**.



Time

The phone has its own clock. In this menu you can set the time and select between the 12-hour or 24-hour time formats.

- **Set time:**

You can set time of your phone in this menu.

- **Time format:**

Your can select time format between 12-hour or 24-hour.

Phone settings [Menu 4-3]

You can set functions relating to the phone.

Display settings

- **Screen saver**

You can set screen saver.

- **Call**

You can set the animation as making a call.

- **Wallpaper**

You can select background picture in a standby mode.



- **Greeting note**

If you select yes, this menu allows you select the standby display. In text mode, you can edit the text.

- **Backlight**

You can set the light-up duration you want whenever you press a key.

- **LCD contrast**



You can set the brightness of LCD you want by pressing $\left(\uparrow\right)$; $\left(\downarrow\right)$.

Languages

You can select the language will be displayed.



Call settings [Menu 4-4]

You can set the menu relevant to a call by pressing [Select] in Setting menu.

Call divert

The Call divert service allows you to divert incoming voice calls, fax calls, and data calls to another number. For details, contact your service provider.

- **All voice calls**

Diverts voice calls unconditionally.

- **If busy**

Diverts voice calls when the phone is in use.

- **If no reply**

Diverts voice calls which you do not answer.

- **If out of reach**

Diverts voice calls when the phone is switched off or out of coverage.

- **All data calls**

Diverts to a number with a PC connection unconditionally.

- **All fax calls**

Diverts to a number with a fax connection unconditionally.



- **Cancel all**

Cancels all call divert service.

- **The submenus**

Call divert menus have the submenus as shown below.

- **Activate**

Activating the corresponding service.

- To other number**

Inputs the number for diverting.

- To favorite number**

You can check 5 diverted numbers.

- To voice mail**

Forwards to message centre. This function doesn't include All data calls and All fax calls menus.

- **Cancel**

Deactivating the corresponding service.

- **View status**

Viewing the status of the corresponding service. Shows the status of Call waiting.



Anykey answer

- **On**

If you select this menu, you can receive a call by pressing any key except  key.

- **Off**

If you select this menu, you can receive an incoming call by only pressing  key.

● Note

- **How to use Handfree portable:**

If you want to use the handsfree portable(earphone), please press the button  for a long time after inserting it to the connector when incoming a call.

Send my number

(network and subscription dependent)

- **Set by network**

If you select this, you can send your phone number depending on two line service such as line 1 or line 2.

- **On**

If you select this, you can send your phone number to the other party. That is, your phone number will be displayed on receiver's phone.

- **Off**

If you select this, you can't send your phone number.



Call waiting

(network dependent)

If this service is Enable, you can accept a waiting (incoming) call.

- **On**

Activating the corresponding service.

- **Off**

Deactivating the corresponding service.

- **View status**

Checking the Status of the service.

Minute minder

If you select **On**, you can check the call duration by beep sound every minute during a call.

Auto redial

- **On**

When this function is set on, your phone will make up to 10 attempts for a call after not connecting.

- **Off**

Your phone will not make any attempts to connect the call after not connecting.



Select line



This function is only used if **Alternate line service** supported by the Service Provider. Two independent phone numbers are registered for the phone. This function provides you with the selection the currently used phone number. If this function is supported by your service provider, the following menu will be displayed.

- **Line 1** : Select Line 1 as the current phone number.
- **Line 2** : Select Line 2 as the current phone number.

Security settings [Menu 4-5]

PIN code request

In this menu, you can set the phone to ask for the PIN code of your SIM card when the phone is switched on. If this function is activated, you'll be requested to enter the PIN code.

1. Press [Menu] in standby mode.
2. Press  key for direct access or use  and  to enter **Settings**.
3. Scroll to highlight **Security settings** menu.
4. Select **PIN code request** by pressing [Select].
5. You can view the following submenus.
 - **On** : Enable PIN code request.
 - **Off** : Disable PIN code request.



Phone lock

You can use security code to avoid unauthorized use of your phone. When you switch on your phone, your phone will request security code always if you set phone lock to “On”. If you set phone lock to “Automatic”, your phone will request security code only when you change your SIM card.

- On
- Off
- Automatic

Automatic key lock

When you enable Automatic key lock, keypad will be lock automatically on an idle screen after 25 seconds without any key requesting.

- On
- Off

Note

- If you want to lock your phone keypad manually, enter Top menu and press  key.
- If you want to unlock your phone keypad, press  [unlock] key and then press  key. But if you enabled Automatic key lock before, your phone keypad will be unlock and then after 25 seconds the keypad will be lock up again automatically.



Call barring

The Call barring service prevents your phone from making or receiving certain category of calls. This function requires the call barring password. You can view the following submenus.

- **All outgoing :**

The barring service of all outgoing calls.

- **International [Outgoing international] :**

The barring service of all outgoing international calls.

- **International except home
[Outgoing international when roam] :**

The barring service of all international outgoing calls except home network.

- **All incoming :**

The barring service of all incoming calls.

- **Incoming when abroad :**

The barring service of all incoming calls when abroad.

- **Cancel all :**

You can cancel all barring service.

- **Change passwd :**

You can change the password for Call Barring Service.



Fixed dial number (SIM dependent)

You can restrict your outgoing calls to selected phone number. The numbers are protected by your PIN2 code.

- **Activate**

You can restrict your outgoing calls to selected phone number.

- **Cancel**

You can call without restricting phone number.

- **Number list**

You can view the number list saved as Fixed dial number.

Change codes

You can change the access codes : **PIN, PIN2, Security code.**

Network settings [Menu 4-6]

You can select the network which you will be registered either automatically or manually. Usually, the selection of the network used by the handset is automatic.

Automatic

The phone automatically selects network which is available in the area.



Manual

The phone will find the list of available networks and show you them. Then you can select the network which you want to use if this network has a roaming agreement with your home network operator.

Preferred

You can set a list of preferred networks the handset should attempt to register with first, before attempting to register to any other networks. This list is created from the handset's predefined list of known networks.

User define

You can add entries or delete new ones from the network list. This can even include new networks whose network codes are not known to the handset. To do this, select and then enter the network code, country code and network name.

Reset settings [Menu 4-7]





You can set the handset to the default configuration by selecting this menu. In addition, you need Security code to activate this function.



Scheduler [Menu 5-1]

On top of the screen there are sections for date and icons. Whenever you change the date, the calendar will be updated according to the date. And square cursor will be used to locate the certain day. If you see under bar on the calendar, it means that there is a schedule that day. This function helps to remind you of your schedule and memo. The phone will sound an alarm tone if you set this for the note.

For changing the day, month, and year.

	Yearly		If you press these keys shortly, you can set the alarm daily. In case of pressing for a long time, you can set it weekly.
	Monthly		

Add new

You can edit maximum 30 characters. You can take a note. You can choose the following types of note. You can make up to maximum 20 notes.

- **Schedule**



Input the subject, the schedule time, the repeat time, alarm time by pressing [Select].

- **Memo**



1. Select **Add New** by pressing [Select].
2. Scroll to highlight **Memo**.
3. Press [Select].
4. Input the memo and then press [Select].



View day

Shows the note for the chosen day. Use  ,  to browse through the note lists. If you set alarm for the note, Alarm watch is displayed. Press [Options] to delete, edit the note you selected.

View all

Shows the notes that are set for all days. Use  ,  to browse through the note lists. You can use the same menu as "View date" by pressing [Options].

Delete past

You can delete for the last schedule already is notified you.

Delete all

You can delete for the all note(s).

Phone book [Menu 5-2]

Search

(Calling from phonebook)

1. Open the phonebook first by pressing [Names] in a standby mode.
2. **Search** by Pressing [Select] to enter.



3. Depending on setting **Search by**, the below menu may not appear.
 - **Name**
 - **Number**
4. You can find an entry by name and number.
5. Select [Search].
6. You can check the names and numbers by pressing [List].
7. If you want to edit, delete, copy an entry, or to add the voice to one, select [Options]. The below menu will be displayed.
 - **Edit** : You can edit the name, number, E-mail, and fax by pressing [OK].
 - **Delete** : You can delete an entry.
 - **View other number** : You can see other phone numbers in names you searched.
 - **Write message** : You can write message.
 - **Copy** : You can copy an entry from SIM to phone or from phone to SIM.
 - **Call** : You can call thru the chosen entry.
 - **Voice** : You can add the voice to the entry or change the voice tag.
 - **Main number** : You can select the one out of mobile, home, office that you often use. The main number will be displayed first, if you set this.



Add new

You can add phonebook entry by using this function.

Phone memory capacity is 200 entries. SIM card memory capacity depends on the service provider.

You can also save 20 characters of name in the Phone memory, and you can save characters in the SIM card. The number of character is SIM dependent feature.

1. Open the phonebook first by pressing [Names] in standby mode.
2. Scroll to highlight **Add new**, and press [Select] to enter.
3. Select the memory you want to save: **SIM** or **Phone**.

- **SIM** : You can add name and number for entry.
 - a. Write a name to add.
 - b. Press [OK], then you can input a number.
 - c. Press [OK].
 - d. If you want to add the voice, press [Yes].
- **Phone** : You can add name, mobile, home, office, fax no. and E-mail address.
 - a. You can select among mobile, home and office by pressing [select].
 - b. Write a name to add.
 - c. Enter the numbers following as mobile, home, office by pressing [Next] for next step [Clear] for cancel and  for saving or exit.
 - d. If you want to add the voice, press [Yes].

You should speak a word within 2 seconds, and the phone asks you to speak it again to ensure the accuracy of voice recognition. After voice recognition has finished, Voice is attached automatically.



Note

- The voice can only be attached to main number which you set. For example, if you change main number voice will be automatically attached changed number.
- You can add voice tag to phone number in SIM card. The voice tag can be erased removing or changing SIM card. And voice tag attached to phone number in SIM card may be attached to another phone number when you changed SIM card. Why? The answer is that SIM card doesn't contain information about voice tag.



Speed dials

You can associate any of the keys 2 to 9 with a Name list entry. You can call directly by pressing this key for 2-3 seconds.

1. Open the phonebook first by pressing [Names] in a standby mode.
2. Scroll to **Speed dials**, then press [Select] to enter this menu.
3. Every Speed dials will be displayed.
4. If you want to add Speed dials, select <Empty>. Then, you can search the name in phonebook.
5. If you select allocated name by Speed dials, you can view following the submenus.
 - **Change** : You can change the allocation of Speed dials number.
 - **Cancel** : You can cancel the allocated Speed dials number.



Voice list

You can see all phone numbers which contain voice. You can also call directly by pressing [Send]. After selecting phone number by using  and  press [Options], you can see following the submenus.

- **Play**

You can play voice which is attached to phone number.

- **Change**

You can change voice which is attached to phone number.

- **Delete**

You can delete voice which is attached to phone number.

- **Call**

You can call by selecting this menu.

Caller groups

You can list up to 20 members per one group. There are 7 groups you can make lists to.

1. Press [Names] to enter into the phonebook in standby mode.
2. Scroll to **Caller groups** item then press [Select] to enter this menu.
3. Every Group list will be displayed.: **Family, Friend, Colleague, VIP, Group1, Group2** and **Others**.
4. Select Group name that you want to manage by pressing [Select].



5. Then submenus below will be displayed.

- **View member**

- You can view the number list in Caller groups.
- You can select the member you want by pressing [Options] then you can enable the submenu such as **Edit, Delete, View other number, Write message, Copy, Voice** and **Main number**.

- **Group ring tone**

You can set the ring tone depending on Group.

- **Group animation**

You can set the animation for each group.

- **Add member**

You can add the member in Caller groups.

1. Scroll to highlight **Add member**, and then press [Select] to enter.
2. The group member shouldn't be exceeded 20. Otherwise, the error message will be displayed.
3. Press [OK] to add member.

- **Delete member**

You can delete the member already saved in phonebook.

- **Rename**

You can change group name.



Copy all

You can copy/move entries from SIM card memory to Phone memory or from Phone memory to SIM card memory.

1. Open the phonebook first by pressing [Names] in standby mode.
2. Scroll to **Copy all**, then press [Select] to enter this menu.
3. Then submenus below will be displayed.
 - **SIM to Phone** : You can copy the entry from SIM Card to Phone memory.
 - **Phone to SIM** : You can copy the entry from Phone memory to SIM Card.

Delete all

You can delete all entries in **SIM, Phone, and Voice**. This function requires Security code.

1. Press [Names] to enter into the phonebook in standby mode.
2. Scroll to **Delete all**, then press [Select].
3. Then select a memory to erase: **SIM, Phone, Voice**.
4. And then you will be requested to enter Security code.
5. Press [OK] or, press [Back] to cancel.

Settings

You can set preferred memory which includes **Variable, SIM or Phone** and preferred search which includes **Variable, Name and Number**.



1. Open the phonebook first by pressing [Names] in a standby mode.
2. Scroll to **Settings**, then Press [Select] to enter.
3. Then submenus below will be displayed.

• Set memory

1. Scroll to highlight **Set memory**, then press [Select] to enter.
2. The three submenus are displayed.
 - **Variable** : If you select Variable, the phone asks you where to store whenever you add entries in Phonebook.
 - **SIM** : If you select SIM, the phone stores entries to SIM directly without asking you where to store.
 - **Phone** : If you select Phone, the phone stores entries to Phone directly without asking you where to store.

• Search by

1. Scroll to highlight Search by, then press [Select] to enter.
2. The three submenus are displayed.
 - **Variable** : If you select Variable, the phone asks you how to search the entries.
 - **Name** : If you select Name, the phone searches entries by name.
 - **Number** : If you select Number, the phone searches entries by number.



Information

- **Service dial number**

Use this function to access a particular list of services provided by your network operator (if supported by the SIM card).

- **Memory status**

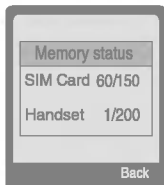

This feature allows you to see how many free and in-use are in your phonebook.







- **Own number (SIM dependent)**

You can check your own number in SIM card.



Calculator [Menu 6-1]

This contains the standard functions such as +, -, x, / : **Add, Subtract, Multiply, Divide.**

1. Input the numbers by pressing numeric keys.
2. Press  key once for Add and long press for Multiply. Press  key once for Subtract and long press for divide.
3. Press  key to input Prime number and  key to input Negative number.
4. You can view the result by pressing [Result] key.
5. If you want to continue the calculation, repeat the process.
6. You can delete the number or sign you want by pressing  .
7. Press  key if you want to end the calculation process.

My folder [Menu 6-2]

All the contents downloaded through M-service or EMS such as images, ringtones and etc, are available in the My folder menu.

In this menu you can check the contents, edit their name and, eventually, set them as wallpapers or ringtones.

Downloaded polyphonic ringtones must be activated in this menu in order to make them available in the audio profiles ringtones list. You can activate just one downloaded ringtone at once.

● Note

You can also attach this objects in an EMS message as described in the Write SMS chapter [Menu 1-1].











Game [Menu 6-3]

The phone offers you enjoyable games to play with.

Note

The Control keys are different for each game. But each game has screens to explain the main control key (see key info.). Other common control keys are below.

[Common Key Function]

-  [Soft 1 Key] : Start game, and Ok key
-  [CLR] : Pause
-  [Soft 2 Key] : Back
-  [END] : Exit
-  : Stage and level control.
-  [Up,down key] : Volume control
-  [Star key] : Navigation to the left
-  [Sharp key] : Navigation to the right



Unit converter [Menu 6-4]

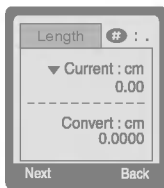

This converts any measurement into a unit you want. There are 4 types that can be converted into units: **Length**, **Area**, **Weight**, and **Volume**.

1. You can select one of four unit types by pressing [Next] key.
2. Select the unit you want to convert by pressing $\left(\frac{\text{cm}}{\text{cm}}\right)$ and $\left(\frac{\text{cm}}{\text{cm}}\right)$.
3. You can toggle between **Current** and **Convert** by long pressing $\left(\frac{\text{cm}}{\text{cm}}\right)$ and $\left(\frac{\text{cm}}{\text{cm}}\right)$.
4. You can input the prime number after the decimal place by pressing $\left(\frac{\text{cm}}{\text{cm}}\right)$.
5. You can delete the number you want by pressing $\left(\frac{\text{cm}}{\text{cm}}\right)$.
6. Press $\left(\frac{\text{cm}}{\text{cm}}\right)$ key or [Back] key if you want to end the process for converting the value.

World time [Menu 6-5]

You can view the time for each city around the world.

when you press $\left(\frac{\text{cm}}{\text{cm}}\right)$, $\left(\frac{\text{cm}}{\text{cm}}\right)$ shortly, you can view the city belonged to the different time zone and when you press $\left(\frac{\text{cm}}{\text{cm}}\right)$, $\left(\frac{\text{cm}}{\text{cm}}\right)$ long, you can view the all of city on the same time zone.

If you want to select the country you want, press [set] key.





Your phone supports services based on Wireless Application Protocol (WAP). You can access services supported by your network. The services menu allows you to get the information such as news, weather reports, and flight times.

Home [Menu 7-1]

You can connect to the configured homepage of the activated profile.

Bookmarks [Menu 7-2]

When you enter this menu, you can see the bookmarks. Then press  button to access available option, or press  to exit it.

- **Connect** : Connect to selected bookmark.
- **Add new** : Add a new bookmark manually.
- **Edit** : Edit the title and the address of the selected bookmark.
- **Delete** : Delete the selected bookmark from the bookmark list.

Push messages [Menu 7-3]

You can receive messages related with WAP which is included URL. So you can connect to indicated URL directly.

Inbox

You can read or delete the push messages.

- **Information** : Allows you connect to a specific site using the information in the received push message.
- **Load** : Allows you connect to a specific site using the information in the received push message.
- **Delete** : Deletes the selected push message.



Setting

You can set push the messages.

Profiles [Menu 7-4]

You can make up to 5 profiles and activate only one of them. Scroll to the desired profile and press  to access available options.

- **Activate**

You can activate the selected profile.

- **Settings**

You can edit and change WAP settings of the selected profile.

- **Homepage**

This setting allows you to enter the address (URL) of the site you want to use as homepage. You do not need to type "http://" in front of each URL as the WAP Browser will automatically add it.

- **Display image**

You can select whether images on WAP cards are displayed or not.

- **Conn. type**

The options for connection type are Continuous or Temporary and depend on the gateway.

- Temporary**

- A non-confirmed (connectionless) service.

- Continuous**

- A confirmed delivery mechanism but generates more network traffic.



- Conn. security

The options are **On** and **Off** depend on the gateway you are using.

- Gateway information

Most of WAP gateways do not require a User ID and Password. If your gateway need them to connect to it, then your network should provide them, and you must set them up correctly before trying to browse a WAP site.

- Bearer

Data

GPRS

- Data settings

The service settings are only available when Data is chosen as a bearer service.

These values of setting are provided by your network.

IP address : Enter the IP address of the WAP gateway you are using to access.

Dial number : Enter the telephone number to dial to access your WAP gateway.

Call type : Select the type of data call.: Analogue or ISDN (Digital).

Call speed : The speed of your data connection.

User ID : The user identity for your dial-up server (and NOT the WAP gateway).

Password : The password required by your dial-up server (and NOT the WAP gateway) to identify you.



- GPRS settings

The service settings are only available when GPRS is chosen as a bearer service.

- Linger timer

You can input timeout periods between 30sec, and 300sec. if any data wasn't input or transferred, the service will be unavailable.

• Rename

Edit the Profile Name.

• Email server

Save the URL of the E-mail server that you frequently use.

- Connect

Connect to the E-mail server that you configured.

- Edit address

Edit the URL of the E-mail server.

Go to URL [Menu 7-5]

You can directly connect to the site that you want. You need to enter the specific URL that you want to directly connect.



Cache settings [Menu 7-6]

You can remove the contents of Cache memory and change the Cache check mode.

Clear cache

The contents of Cache memory will be removed.

Check cache

You can change the time for checking the Cache memory.

- **Always**

The cache is always checked whenever URL is loaded or navigated.

- **Start only**

The cache is only checked when the WAP is started.

- **Off**

The cache is never checked.

Security certifications [Menu 7-7]

A list of the available certificates is shown.

Reset profiles [Menu 7-8]

You can reset all the current settings of profiles to the factory default.



Applications [Menu 8-1]

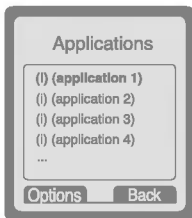

Java Menu Options

Scroll to an application and select Options.

- 1. Open** : Launches the selected MIDlet.
- 2. Delete** : Deletes the selected MIDlet.
- 3. Update** : Accesses the server and updates the selected MIDlet.
- 4. Information** : Displays information about the selected MIDlet.
- 5. Phone settings** : Allows you to set backlight and sound for java game.



JAVA™ is a trademark of Sun Microsystems, Inc.



Memory status [Menu 8-2]

Shows the size of memory available for game and application installations. You can also see the whole memory status of Handset.

Download [Menu 8-3]

See [Menu 7-2]. You can edit and set MIDlet server address. Download MIDlets using WAP Browser and store them in the phone. You can also view the list of MIDlets stored on the Applications screen.

If you are on line, you can see the following menus.

Home

This is the same as [Menu 7-1].

Reload

This reloads the current page.

Bookmarks

This is the same as [Menu 7-2].

Save as bookmarks

Save the current URL as a bookmark. You can also edit the bookmark title.

Go to URL

Same as [Menu 7-5].

Go to e-mail server

Connect to the E-mail server that you configured.

Set as e-mail server

Save the current URL as an E-mail server.

Save image

Save the browsed image.

To be able to data or fax service, you need the communicate software such as a data or a fax program. Before using these functions, you need to connect your phone to a computer or make sure that your phone is in connection with a compatible device.

Sending Data or Fax Calls

1. Connect your computer to the phone.
2. After starting the communicate software, make a call and transmit a data or fax.
3. After the data or fax transmission, you can end the call by just ending of the communicate software, pressing [End].

Receiving Data or Fax Calls

If you have separate numbers for voice, data and fax calls, your phone recognizes the type of call.

Receiving Data or Fax Calls – Separate numbers (Multi-numbers)

To use a data or a fax service, the display shows which type of call you are receiving.

To receive a data or fax call.

1. Connect your computer to the phone.
2. After starting the communicate software, accept a call and receive a data or fax (if it is not answered automatically).
3. After the data or fax reception, you can end the call by just ending of the communicate software, pressing [End].

Receiving Data or Fax Calls – Single number

If you have a SIM card that does not support separate voice, data and fax numbers, the phone does not recognize the type of incoming call.

To use a data or a fax service, make sure that you want to receive a data or fax call mode. You first have to set the phone to one of these options in the call mode (Settings → Call Setting → Next Incoming) sub menu.

To receive a data or fax call.

1. Press [Menu] in standby mode.
2. Select the call type you want (Voice, Data or Fax) and press [Select].
3. Connect your computer to the phone.
4. After starting the communicate software, accept a call and receive a data or fax (if it is not answered automatically).
5. After the data or fax reception, you can end the call by just ending of the communicate software, pressing [End].

Once you have set your phone for a specific incoming call, it remains set until you change it.

● PC Sync

PC Sync is a program for data exchange PC & Phone by data cable. Therefore, if you want to use this function, you have to buy accessory kit. About more detail for using guide refers to PC Sync Help file on the PC Sync CD.

During a call, the following menus will be displayed, not in a standby mode.

1 During a call

1-1 Putting a Call on Hold

You can place a call on hold or retrieve by just pressing the [Send] key. When a call is made or answered, press the [Send] key to place it on hold. When a call is held, press the [Send] key to make it active.

1-2 Making a Second Call

You can get a dial number from phonebook to make a second call. Press [Names] key then select **Search**. To save the dial number into phonebook during call, press [Names] key then select **Add new**.

1-3 Swapping Between Two Calls

To switch between two calls, select the [Options] key, then select Swap or just press [Send] key.

You can make one of two calls focused by pressing up/down arrow key. If you want to end one of two calls, make the call you want to end focused, then press [End] key when the call you want to end is focused.

1-4 Answering an Incoming Call

To answer an incoming call, simply press the [Send] key.

The handset is also able to warn you of an incoming call while you are already in a call. A tone sounds in the earpiece, and the display will show that a second call is waiting.

If Call Waiting is on, you can put the first call on hold and answer the second, by pressing [Send] or by selecting the [Answer] key.

You can end the current call and answer the waiting call by selecting the [Menu] key, then **End & Answer**.

1-5 Rejecting an Incoming Call

You can reject an incoming call without answering by simply pressing the [End] key.

When in a call you can reject an incoming call (1st call) by pressing the [Menu] key and selecting **Multiparty/End and Answer** or by pressing [End] key.

1-6 Controlling the volume during a call

You can control the volume during a call by pressing [Options] key and selecting **Volume** followed by  or .

1-7 Muting the Microphone

You can mute the microphone during a call by pressing the [Options] key then selecting **Mute**. The handset can be unmuted by pressing the [Unmute].

When the handset is muted, the caller cannot hear you, but you can still hear them.

1-8 Switching DTMF Tones on During a Call

To turn DTMF tones on during a call, for example, to allow your handset to make use of an automated switchboard, select the [Options] key, then **DTMF On**. DTMF tones can be turned off the same way.

1-9 Calling up the messages or SIM Tool Kit

The Messages and SIM Tool kit main menu options can be reached from the in-call menu by selecting the [Options] key, then **Messages or SIM Tool Kit** (Screen name depends on the network operator's SIM). SIM Tool kit menu is shown only when SIM in the handset supports SIM Tool kit service.

2 Multiparty or Conference Calls

The multiparty or conference service provides you with the ability to have a simultaneous conversation with more than one caller, if your network service provider supports this feature.

A multiparty call can only be set up when you have one active call and one call on hold, both calls having been answered. Once a multiparty call is set up, calls may be added, disconnected or separated (that is, removed from the multiparty call but still connected to you) by the person who set up the multiparty call. These options are all available from the in-call menu and are listed in Section.

The maximum callers in a multiparty call is five. Once started, you are in control of the multiparty call, and only you can add calls to the multiparty call.

2-1 Making a Second Call

You can make a second call while you are already in a call. To do this, enter the second number and press [Send]. When you get second call the first call is automatically put on hold. You can swap between calls by selecting the [Options] key then **Swap**.

2-2 Setting up a Multiparty Call

You can connect a call on hold to the currently active call to form a multiparty call by selecting the [Options] key then **Multiparty/Join all**.

2-3 Putting the Multiparty Call on Hold

To put a multiparty call on hold, select the [Options] key then **Multiparty/Hold all**.



2-4 De-activate the Multiparty Call on Hold

To de-activate a multiparty call on hold, select the [Options] key then **Multiparty/Join all**.

2-5 Adding Calls to the Multiparty Call

To join an active call to the held multiparty call, select the [Options] key then **Multiparty/Join all**.

2-6 Displaying Callers in a Multiparty Call

To scroll through the numbers of the callers who make up a multiparty call on the handset screen, press  and  keys.

2-7 Putting a Member of a Multiparty Call on Hold

To place one selected caller (whose number is currently displayed on-screen) of a multiparty call on hold, select the [Options] key then **Multiparty/Exclude**.

2-8 A Private Call in a Multiparty Call

To have a private call with one caller of a multiparty call, display the number of the caller you wish to talk to on the screen, then select the [Options] key and **Multiparty/Private** to put all the other callers on hold.

2-9 Ending a Multiparty Call

The currently displayed caller of a multiparty call can be disconnected by pressing the [End] key. To end a multiparty call, press the [Options] key then select **Multiparty/End** multiparty.

Selecting the [Options] key then **Multiparty/End all**, will end all the active and held calls.

2-10 Explicit Call Transfer (ECT)

If you have one caller on hold and another active call, you may connect one call party to another call party and then leave the call. This is done by selecting the **Multiparty/Transfer** option from the in-call menu.

Accessories

There are various accessories for your mobile phone. You can select these options according to your personal communication requirements.



Standard Battery



Portable Handsfree

This connects to your phone, allowing handsfree operation.



Travel Adapter

This charger allows you to charge the battery while away from home or your office.



Cigar Lighter Adapter

You can operate the phone and trickle charge the phone's battery from your vehicle by using the cigarette lighter charger.



Neckstrap

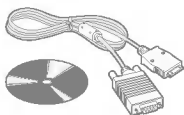

Data Kit/CD

You can connect your phone to PC to exchange the data between them.

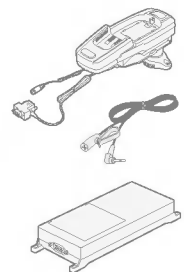

Handsfree Kit

The handsfree car kit enables you to attach the phone to the power jack in your car, providing you with handsfree operation.

● Note

- Information and specification in this menu is subject to change without prior notice.
- Accessories may be different in different regions; please check with our regional service company or agent for further enquiries.

Care and Maintenance

When using this unit, basic safety precautions as below should be always followed.

- Do not touch the adapter with wet hands.
- Do not disassemble this unit. (Take it to a qualified service technician when repair work is required.).
- Away from electrical appliance such as a TV, radio or personal computer.
- The unit should be situated from heat sources such as radiators or cookers.
- Do not drop.
- Do not subject this unit to mechanical vibration or shock.
- The coating of the phone may be damaged if covered with wrap or vinyl wrapper.
- Use dry cloth to clean the exterior of the unit. (Do not use solvent such as benzene, thinner or alcohol.)
- Do not subject this unit to excessive smoke or dust.
- Do not keep the phone next to credit cards or transport tickets; it can be affected the information on the magnetic strips.
- Do not tap the screen with a sharp object; otherwise, it may damage the phone.
- Do not expose the phone to liquid or moisture.
- Use the accessories like an earphone cautiously. Do not touch the antenna unnecessarily.

■ Caring for the Battery

- You do not need to completely discharge the battery before recharging. Unlike other battery systems, there is no memory effect that could compromise the battery's performance.
- Use only LG batteries and chargers. LG chargers are designed to maximize the battery life.
- Do not disassemble or short-circuit the battery pack.
- Keep the metal contacts of the battery pack clean.
- Replace the battery when it no longer provides acceptable performance. The battery pack may be recharged hundreds of times until it needs replacing.
- Recharge the battery if it has not been used for a long time to maximize usability.
- Do not expose the battery charger to direct sunlight or use it in high humidity, such as the bathroom.
- Do not leave the battery in hot or cold places, this may deteriorate the battery performance.

Technical Data

General

Product Name : G5300i

System : GSM 900/DCS 1800

Ambient Temperatures

Max : +55°C

Min : -10°C

Declaration of Conformity



This model complies with the essential requirements of Article 3 of the R&TTE 1999/5/EC Directive, if used for its intended use.

1. Health (Article 3.1.a of the R&TTE Directive)
2. Safety (Article 3.1.a of the R&TTE Directive)
3. Electromagnetic compatibility (Article 3.1.b of the R&TTE Directive)
4. Efficient use of the radio frequency spectrum (Article 3.2 of the R&TTE Directive)

I hereby declare under our sole responsibility that the product mentioned above to which this declaration relates complies with the above mentioned articles of the directive.

If available, write the contact person(s)

Mr. Jin Seog, Kim
LG Amsterdam Branch Office
Capronlaan 6, 1119 NR Schiphol-rijk,
The Netherlands
(Tel.) +31-20-655 7774

Mr. Ji Jong, Jeon
LG Electronics Inc. GSM Division
Emerald BD, 1042 Hoge-Dong, Dongan-Gu
Anyang-city, Kyuonki-Do
431-080, Korea

CE 0700

