

User's Guide

L2323T

Make sure to read the **Important Precautions** before using the product.
Keep the User's Guide(CD) in an accessible place for future reference.

See the label attached on the back cover and quote this information to your dealer when you require service.

Important Precautions

This unit has been engineered and manufactured to ensure your personal safety, however improper use may result in potential shock or fire hazards. In order to allow the proper operation of all safeguards incorporated in this display, observe the following basic rules for its installation, use, and servicing.

On Safety

Use only the power cord supplied with the unit. In case you use another power cord, make sure that it is certified by the applicable national standards if not being provided by the supplier. If the power cable is faulty in any way, please contact the manufacturer or the nearest authorized repair service provider for a replacement.

The power supply cord is used as the main disconnection device. Ensure that the socket-outlet is easily accessible after installation.

Operate the display only from a power source indicated in the specifications of this manual or listed on the display. If you are not sure what type of power supply you have in your home, consult with your dealer.

Overloaded AC outlets and extension cords are dangerous. So are frayed power cords and broken plugs. They may result in a shock or fire hazard. Call your service technician for replacement.

Do not Open the Display.

- There are no user serviceable components inside.
- There are Dangerous High Voltages inside, even when the power is OFF.
- Contact your dealer if the display is not operating properly.

To Avoid Personal Injury :

- Do not place the display on a sloping shelf unless properly secured.
- Use only a stand recommended by the manufacturer.

To Prevent Fire or Hazards:

- Always turn the display OFF if you leave the room for more than a short period of time. Never leave the display ON when leaving the house.
- Keep children from dropping or pushing objects into the display's cabinet openings. Some internal parts carry hazardous voltages.
- Do not add accessories that have not been designed for this display.
- During a lightning storm or when the display is to be left unattended for an extended period of time, unplug it from the wall outlet.
- Do not place objects on top of the media station or cover it. Obstructing ventilation holes may damage your media station or overheat the machine causing fire.



On Installation

Do not allow anything to rest upon or roll over the power cord, and do not place the display where the power cord is subject to damage.

Do not use this display near water such as near a bathtub, washbowl, kitchen sink, laundry tub, in a wet basement, or near a swimming pool.

Displays are provided with ventilation openings in the cabinet to allow the release of heat generated during operation. If these openings are blocked, built-up heat can cause failures which may result in a fire hazard. Therefore, NEVER:

- Block the bottom ventilation slots by placing the display on a bed, sofa, rug, etc.
- Place the display in a built-in enclosure unless proper ventilation is provided.
- Cover the openings with cloth or other material.
- Place the display near or over a radiator or heat source.

Do not rub or strike the Active Matrix LCD with anything hard as this may scratch, mar, or damage the Active Matrix LCD permanently.

Do not press the LCD screen with your finger for a long time as this may cause some afterimages.

Some dot defects may appear as Red, Green or Blue spots on the screen. However, this will have no impact or effect on the display performance.

If possible, use the recommended resolution to obtain the best image quality for your LCD display. If used under any mode except the recommended resolution, some scaled or processed images may appear on the screen. However, this is characteristic of the fixed-resolution LCD panel.

On Cleaning

- Unplug the display before cleaning the face of the display screen.
- Use a slightly damp (not wet) cloth. Do not use an aerosol directly on the display screen because over-spraying may cause electrical shock.

On Repacking

- Do not throw away the carton and packing materials. They make an ideal container in which to transport the unit. When shipping the unit to another location, repack it in its original material.

Please make sure the following items are included with your monitor. If any items are missing, contact your dealer.

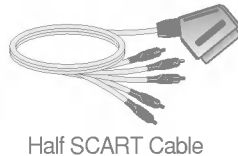
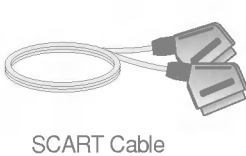
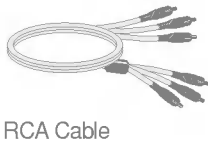
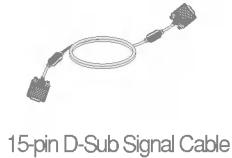
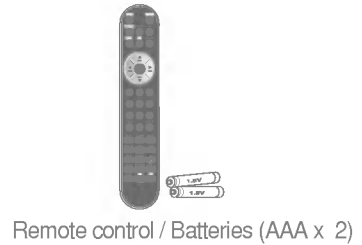
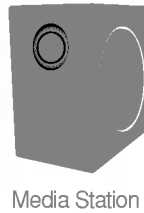
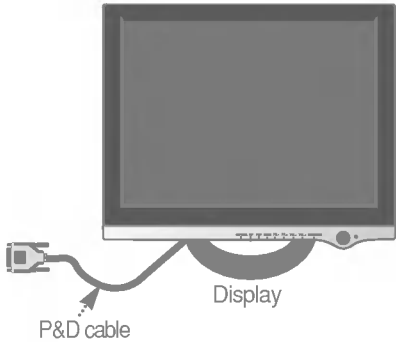

SCART Cable / Half SCART Cable
-It varies from country/region to country/region.

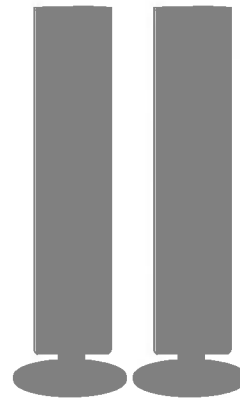

Please see the Speaker User Manual (included in the speaker box) to reference the speaker accessory list.

For detailed instructions of each button on the remote control, refer to the appropriate pages of this manual.

Remote Control

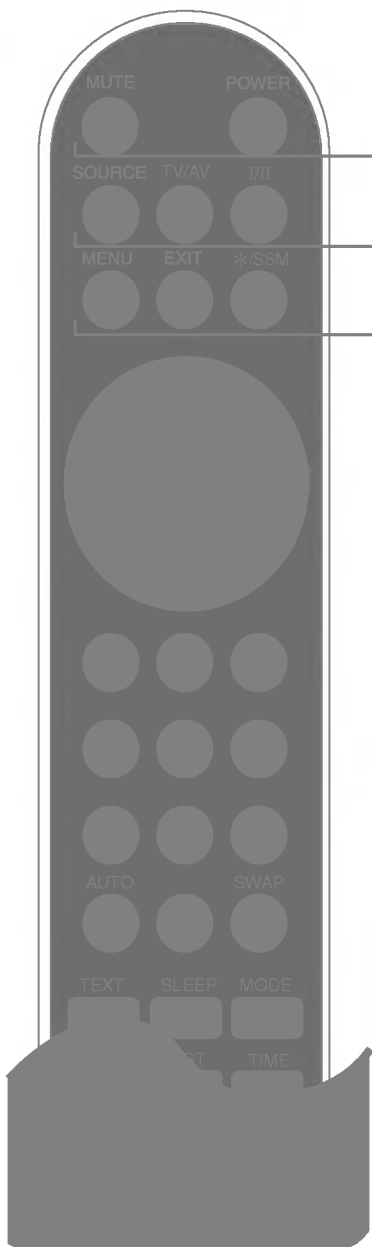

MUTE

To select mute on or off.

POWER

Use this button to turn the display on or off.

SOURCE

Use this button to select an input signal.

TV/AV : TV/AV button

I/II : Bilingual choice and sound mode selection

Press this button

- to switch from **Stereo** to **Mono** sound in case of stereo transmission, or from **Nicam Stereo** to **Nicam Mono**, in case of digital transmission.
- to switch from **Nicam Dual I** to **Nicam Dual II** or **Nicam Dual I-II** in case of Nicam Dual transmission.
- to choose between **Dual I**, **Dual II** or **Dual I-II** in case of bilingual transmission :
Dual I sends the primary broadcast language to the loudspeakers ;
Dual II sends the secondary broadcast language to the loudspeakers ;
Dual I-II sends a separate language to each loudspeakers.

■ **NOTE** : In case of weak stereo sound signals, with stereo or Nicam stereo transmission, select mono reception.

MENU

Use this button to enter the On Screen Display menu.

EXIT

Use this button to exit the On Screen Display menu.

* / SSM (Sound Status Memory)

The audio will be automatically calibrated according to the type of the playback video.

- Flat: The most commanding and natural audio.
- Music: Select this option to listen to music.
- Movie: Select this option to watch a movie.
- Speech: Select this option to listen to spoken word.
- User: Select this option to use the user-defined audio settings.

Using the Remote Control

Remote Control

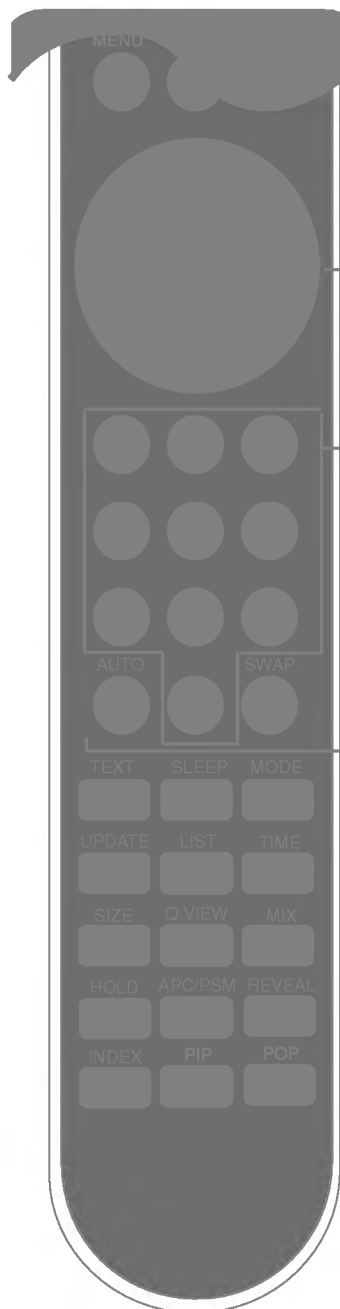

PR (▲▼) Buttons
VOL (◀▶) Buttons
OK Button

Number buttons

AUTO Button

- This function is to automatically search the available channels. It is available to the TV signal inputs only.
- This function is to automatically adjust your display image to the ideal settings for the current screen resolution size (display mode). It is available to the PC analog signal input only.

SWAP function

To switch the main-screen and sub-screen in PIP/POP mode.



Remote Control

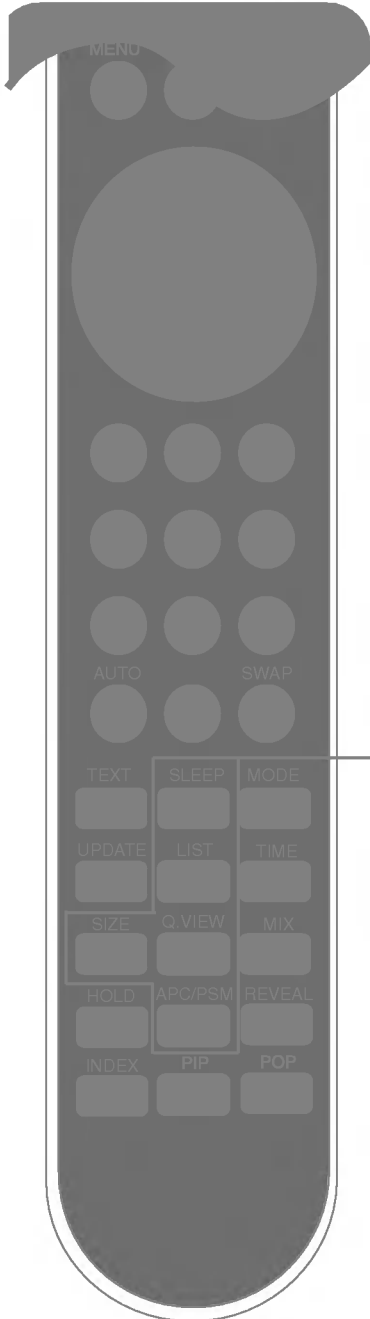

SLEEP : SLEEP Timer

You can set a time period after which the HDTV/S-VIDEO/AV1/AV2 /TV should switch itself to standby. Press the key repeatedly to select the number of minutes.

LIST : Programme list

To display the programme list (0~ 99).

0	----	5	----
1	----	6	----
2	C 04	7	----
3	C 25	8	----
4	----	9	----

Note: TV channels displayed in blue have been setup to skipped in the PR. EDIT menu

Q.VIEW : QUICK VIEW Button

To display the previously selected TV channel.

APC/PSM(Picture Status Memory)

Press repeatedly to select DYNAMIC, STANDARD, MILD, GAME or USER picture mode. This function is not supported in PC mode.

SIZE

Press repeatedly to select the image size of the screen.

FULL/4:3/ SPECTACLE /ZOOM1/ZOOM2/AUTO. SPECTACLE, ZOOM1, ZOOM2 and AUTO functions are useful for TV or motion pictures, but not suitable for PC environments such as computer graphics or word processing.

When using the Teletext function, this button responds in a different way.



Remote Control - PIP/POP function



PIP (Picture in Picture)

The sub-screen is changed in the order shown below.

: SMALL -> LARGE -> OFF

POP (Picture out Picture)

The sub-screen is changed in the order shown below.

: POP1 -> POP2 -> POP3 -> POP4 -> OFF

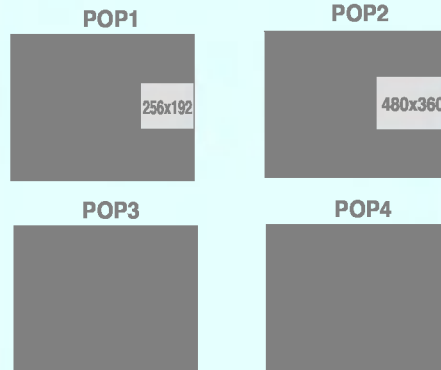

The POP4 menu will not be supported if the input signal is HDTV and/or above 720p.

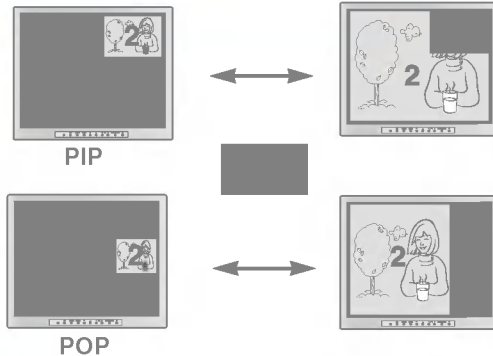

SOURCE 2 \ SOURCE 1	D-SUB	DVI-D	AV	S-VIDEO	HDTV	TV
D-SUB	X	X	●	●	●	●
DVI-D	X	X	●	●	●	●
AV	●	●	X	X	●	X
S-VIDEO	●	●	X	X	●	X
HDTV	●	●	●	●	X	●
TV	●	●	X	X	●	X

[Table of PIP/POP Function Support]

When the signal of **SOURCE 1** is supplied to the main-screen, the sub-screen receives the signal of **SOURCE 2** only. Conversely, when the signal of **SOURCE 2** is supplied to the main-screen, the sub-screen only receives the signal of **SOURCE 1**. The positions of **SOURCE 1** and **SOURCE 2** can be transposed by selecting **SWAP**.

Remote Control - Using the Teletext function

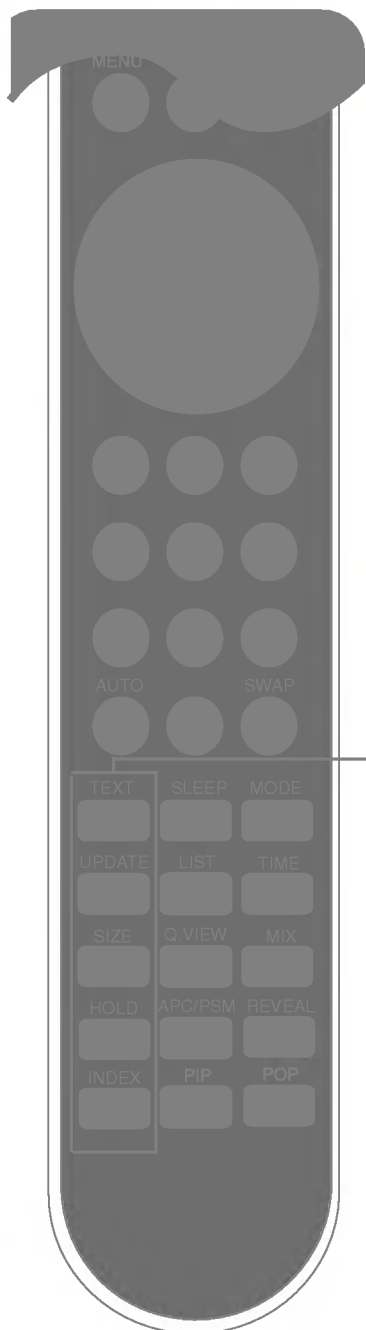

TEXT

To select the teletext on or off. The main index page or the last selected page appears on the screen together with an information headline and an option line at the bottom of the screen.

UPDATE

Press the button to appear the TV programme. At the top of screen indicates that you are still in the teletext mode. Before interrupting teletext, you may select a page number. When the page has been found, the information line appears briefly on your screen. Press the button again to reappear teletext.

SIZE

Press the button repeatedly to display the upper part, the lower part and then to return to the normal page size. When the upper part is displayed, you can scroll the text, line by line using the ▲ ▼ buttons.

HOLD

Press the button to stop the automatically rotating of the subpages. Press the button again to continue the automatic rotating again.

INDEX

To display the main index.

Remote Control - Using the Teletext function



MODE

The mode will be switched in the Teletext mode.

TIME

When viewing a TV programme, press this button to display the time at the top right hand corner of the screen. Press this button again to remove the display. In the teletext mode, press this button to select a sub page number. The sub page number is displayed at the bottom of the screen. To hold or change the sub page, press the RED/GREEN, ▲ ▼ or NUMBER buttons. Press again to exit this function.

MIX

Display the teletext pages superimposed on the TV picture. To switch the TV picture off press this button again.

REVEAL

Press the button to reveal/conceal the hidden information, such as solutions to riddles and puzzles. Press this button again to remove the information from the display.



Insert the batteries into the remote control to operate the monitor.

Preparing the Remote Control

1. Open the battery cover.
2. Insert batteries (AAA size).
Make sure to match the + and - on the batteries to the marks inside the battery compartment.
3. Close the cover.

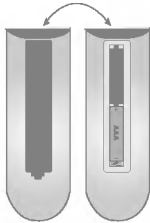

Note

- Do not insert the batteries into the remote control in the wrong direction.
- Do not charge, heat, open, or short-circuit the batteries. Also do not throw the batteries into the fire.
- Do not use different types of batteries together, nor mix old and new batteries.

This section shows you how to use the remote control.

Operating with the Remote Control

Point the remote control at the remote sensor and press the buttons.



Within about 23ft (about 7m)



Distance : About 23 ft (7 m) from the front of the remote sensor.

Angle : About 30° in each direction of the front of the remote sensor.

Do not expose the sensor of remote control in the monitor to a strong light source such as direct sunlight or illumination. If so, may not be able to operate the monitor with the remote control.

Note

- Do not drop the remote control or handle it roughly.
- Do not leave the remote control in extremely hot or humid conditions.
- Do not expose the remote control to water or anything wet.

Connecting the Display

Media Station Rear

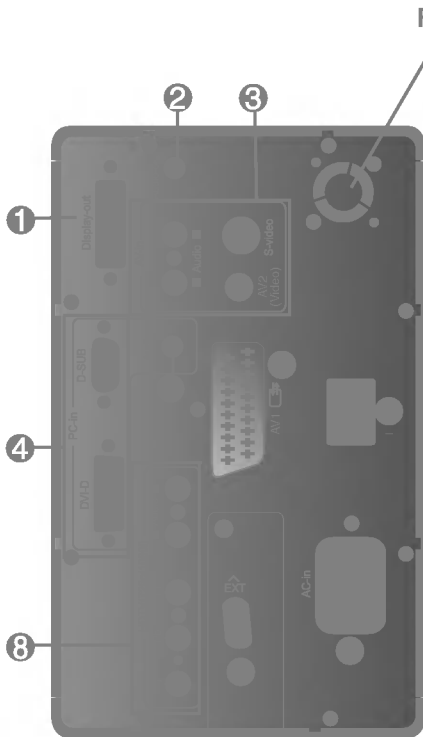

Fan: Should the temperature of the media station rise above a preset level, the fan will start up automatically to cool down the unit.

- 1 Connect the P&D cable
- 2 Connect to the speaker including a built-in amplifier(AMP)
- 3 AV Input ports
- 4 PC signal inputs
- 5 Connect the audio cable to the *LINE OUT jack of the PC sound card.
- 6 Connect the SCART cable
- 7 **Power cut-off switch of the monitor**
Connect various cables and the power cord and turn on before using the monitor. Please turn the switch off if you intend not to use it for an extended period of time to reduce power consumption.
- 8 **HDTV(YPbPr) Input ports**
- 576p/720p/1080i
- 9 Connect the antenna cable (not included)
- 10 Connect the power cord

*LINE OUT

A terminal used to connect to the speaker including a built-in amplifier (Amp). Make sure that the connecting terminal of the PC sound card is checked before connecting. If the Audio Out of PC sound card has only Speaker Out, reduce the PC volume.

If the Audio Out of the PC sound card supports both Speaker Out and Line Out, convert to Line Out using the card jumper of the program (Refer to the Sound Card Manual).

- Before setting up the monitor, ensure that the power to the monitor, the computer system, and other attached devices is turned off.

Using the Computer

1. Connect the P&D (Plug and Display) cable. When attached, tighten the thumbscrews to secure the connection.

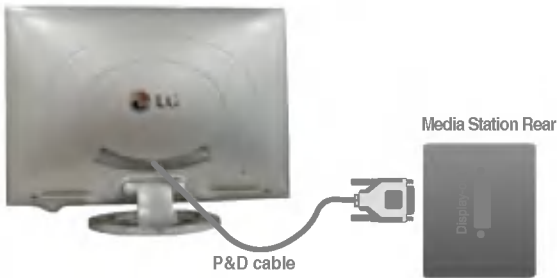

2. Connect the signal cable

● When connecting D-SUB signal cable

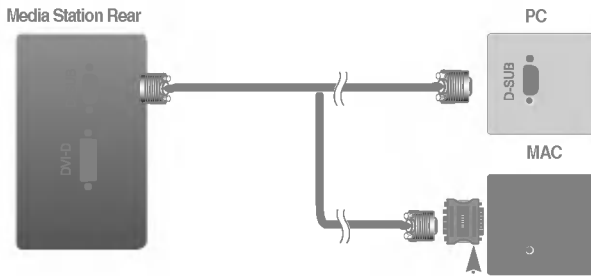

Mac adapter (not included)

For Apple Macintosh use, a separate plug adapter is needed to change the 15 pin high density (3 row) D-sub VGA connector on the supplied cable to a 15 pin 2 row connector.

● When connecting DVI-D signal cable

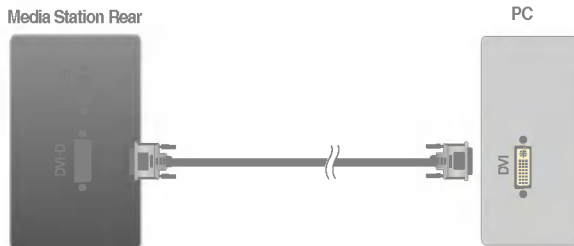

Connecting the Display

3. Connect the power cord into a proper power outlet that is easily accessible and close to the display.

Media Station Rear

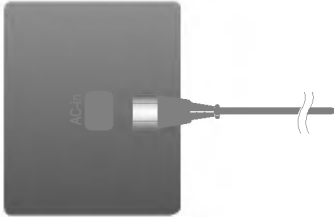

4. Turn the media station power on.

Media Station Rear



5. Select an input signal.

Press the **SOURCE** button on the remote control to select an input.

- When connecting D-SUB signal cable
 - DSUB ANALOGUE: 15-pin D-sub analogue signal
- When connecting DVI-D signal cable
 - DVI-D DIGITAL: DVI-D digital signal

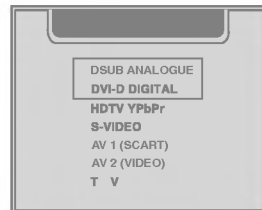

Connecting the Speakers

Connect the audio cable.

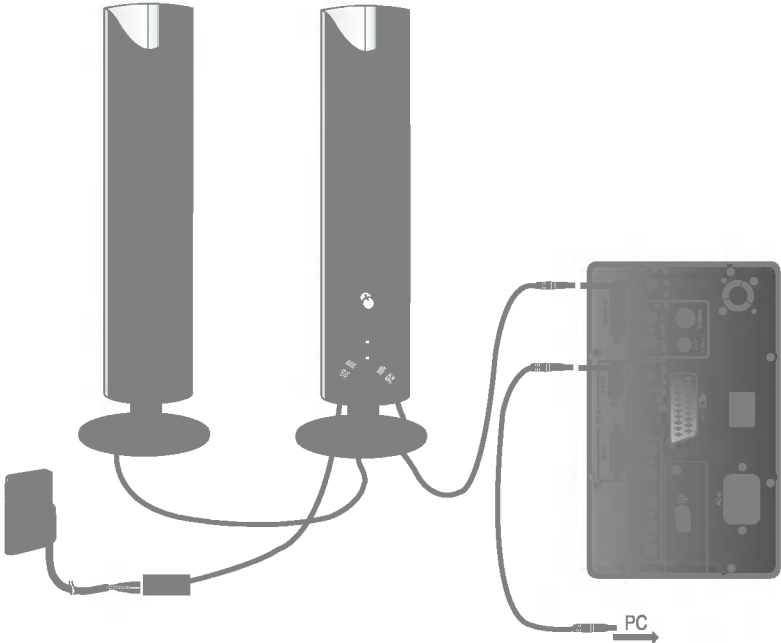

Connecting the external equipment

Connecting the VCR/DVD

1. When connecting RCA cable

Connect the each audio/video output jack of the VCR/DVD to the corresponding input port as shown on the Display (or Media station).

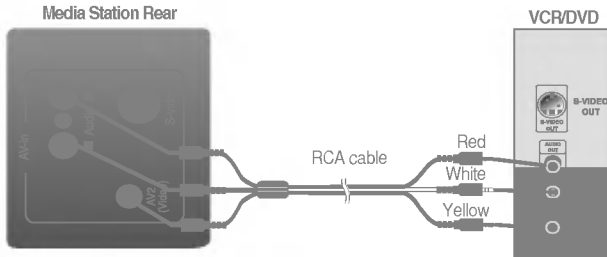

When connecting S-Video cable

If you connect the S-Video input port to external equipment, you can have an improved definition image.

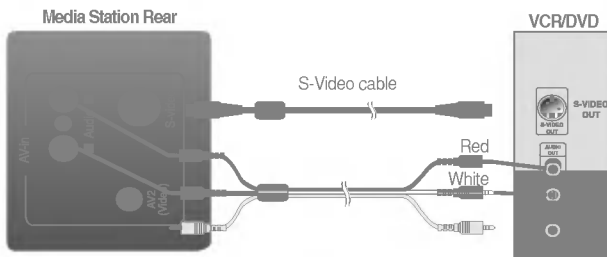

When connecting SCART cable

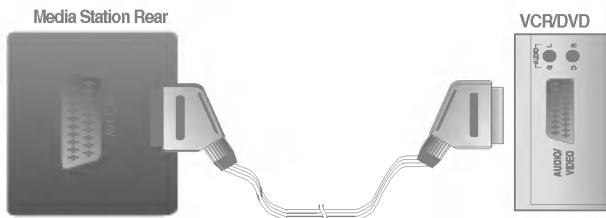

2. Select an input signal.

Press the **SOURCE** button on the remote control to select an input.

- When connecting RCA cable
 - AV2 (VIDEO)
- When connecting S-Video cable
 - S-VIDEO
- When connecting SCART cable
 - AV1 (SCART)

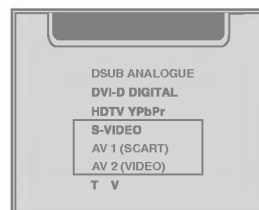

Watching HDTV (720p/1080i)

1. Connect both HDTV cable (Y/Pb/Pr) and audio cable (Audio L/R) to the Display (or Media station) jack and the Set-top box jack.

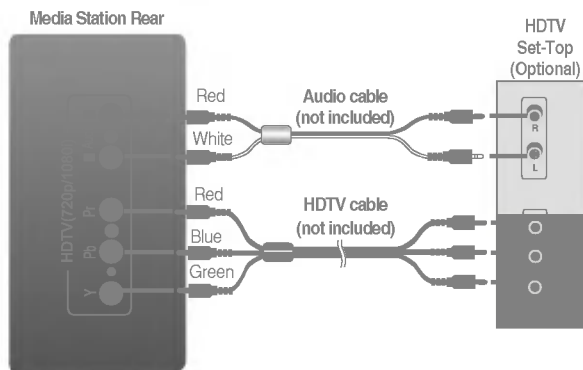

2. Select an input signal.

Press the **SOURCE** button on the remote control to select an input.

- HDTV YPbPr

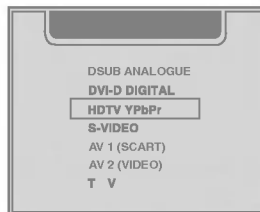

Connecting the HDTV/DVD(576i only)

Take these connection steps if the HDTV/DVD player has a RCA jack and the output is 576i only.

1. Connect half of the SCART cable.

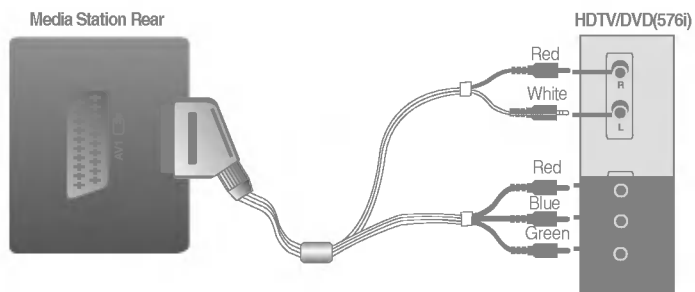

2. Select an input signal.

Press the **SOURCE** button on the remote control to select an input.

- AV1 (SCART)



Connecting the external equipment

Watching TV

- Before setting up the monitor, ensure that the power to the monitor, the computer system, and other attached devices is turned off.

1. Connect the antenna.

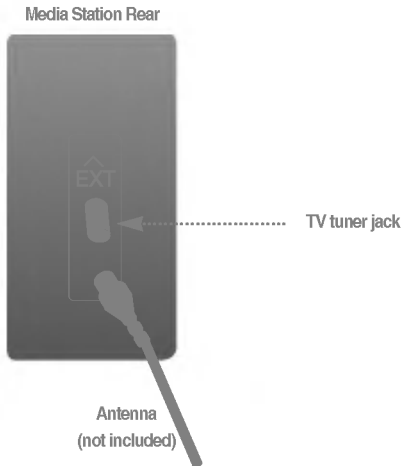

2. Select an input signal.

Press the **SOURCE** button on the remote control to select an input.

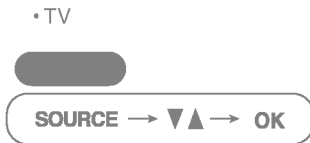





AUTO AV switching

If your VCR is connected to the euroconnector and the VCR is switched to playback, the TV will automatically change to AV1(SCART) mode. If you want to keep watching in TV mode, press the **PR** (▲▼) Buttons or press the number buttons. When you select a TV input signal from other sources, the AV1 (SCART) signal will be displayed immediately if it is available. You can connect a DVD, VCR or satellite receiver to the AV1 (SCART) terminal.

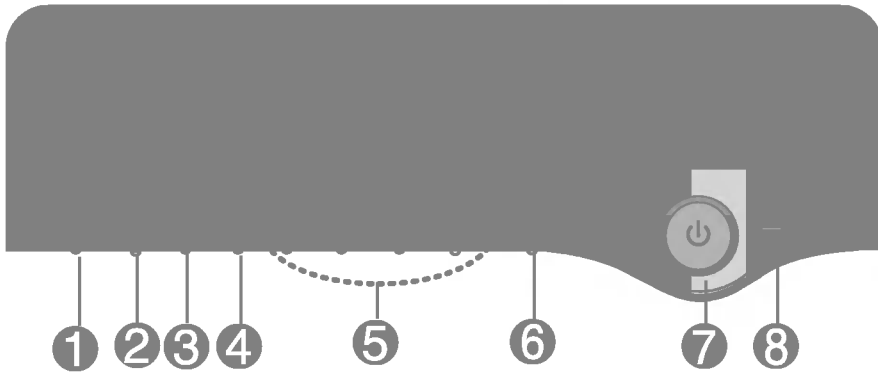



Control Panel Functions

Front Panel Controls

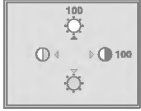
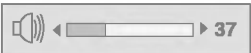

<p>1</p>  <p>DSUB ANALOGUE DVI-D DIGITAL HDTV YPbPr S-VIDEO AV 1 (SCART) AV 2 (VIDEO) T V</p>	<p>Source Selection:</p> <p>Use this button to select an input signal.</p> <ul style="list-style-type: none">• DSUB ANALOGUE: 15-pin D-sub analogue signal• DVI-D DIGITAL: DVI-D digital signal• HDTV YPbPr: HDTV• S-VIDEO: S video• AV1 (SCART) : SCART• AV2 (VIDEO) : CVBS• TV: TV
<p>2</p>  <p>A television screen showing a main image and a smaller inset image in the top right corner, labeled with the number 2.</p>	<p>PIP (Picture in Picture) function</p> <p>The sub-screen is changed in the order shown below. : SMALL -> LARGE -> OFF</p> <p>The positions of SOURCE 1 and SOURCE 2 can be transposed by selecting SWAP on the remote control.</p>
<p>3</p>  <p>A television screen showing a main image and a smaller inset image in the bottom right corner, labeled with the number 3.</p>	<p>POP (Picture out Picture) function</p> <p>The sub-screen is changed in the order shown below. : POP1 -> POP2 -> POP3 -> POP4 -> OFF</p> <p>The positions of SOURCE 1 and SOURCE 2 can be transposed by selecting SWAP on the remote control.</p>



<p>4 MENU Button</p>	<p>Use this button to enter or exit the On Screen Display.</p>
<p>5</p>  	<ul style="list-style-type: none"> • Bring up Contrast and Brightness adjustment. It is available to the PC signal inputs only. • PR. - / PR. + → PR. - / PR. + : To adjust the brightness • VOL. - / VOL. + : To adjust the contrast • Use these buttons to go up and down the channel when the TV source is available. • PR. - / PR. + • VOL. - / VOL. + • Use these buttons to decrease or increase the volume level. • Use these buttons to choose or adjust items in the On Screen Display.
<p>6</p> 	<p>AUTO adjustment function</p> <p>When adjusting your display settings, always press the AUTO/SELECT button before entering the On Screen Display(OSD). This will automatically adjust your display image to the ideal settings for the current screen resolution size (display mode). It is available to the PC signal inputs only.</p> <p>The best display mode is 1280x768 @60Hz.</p> <p>Use this button to enter a selection in the On Screen Display.</p>
<p>7 Power Button</p> <p>Power (DPMS) Indicator</p>	<p>Use this button to turn the display on or off.</p> <p>This Indicator lights up blue when the display operates normally. If the display is in DPM (Energy Saving) mode, this indicator color changes to amber.</p>
<p>8 Remote Control Sensor</p>  	<p>CONTROLS LOCKED/UNLOCKED :</p> <p>MENU and VOL.+</p> <p>This function allows you to secure the current control settings, so that they cannot be inadvertently changed. Press and hold the MENU button and VOL.+ button for 5 seconds: the message “CONTROLS LOCKED” appears.</p> <p>You can unlock the OSD controls at any time by pushing the MENU button and VOL.+ button for 5 seconds: the message “CONTROLS UNLOCKED” will appear.</p>

On Screen Display (OSD) Control Adjustment

Screen Adjustment

Making adjustments to the image size, position and operating parameters of the display is quick and easy with the On Screen Display Control system. A short example is given below to familiarize you with the use of the controls. The following section is an outline of the available adjustments and selections you can make using the OSD.



To make adjustments in the On Screen Display, follow these steps:

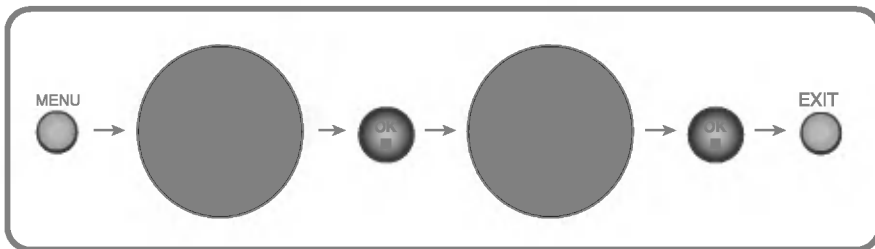

- 1** Press the **MENU Button**, then the main menu of the OSD appears.
- 2** To access a control, use the **▼** or **▲** **Buttons**. When the icon you want becomes highlighted, press the **OK Button**.
- 3** Use the **▼▲◀▶** **Buttons** to adjust the item to the desired level.
- 4** Accept the changes by pressing the **OK Button**.
- 5** Exit the OSD by Pressing the **EXIT Button**.



The following table indicates all the On Screen Display control, adjustment, and setting menus.

On Screen Display Control, Adjustment, and Setting Menus				
Main menu	Sub menu	A	D	Reference
BRIGHTNESS CONTRAST	BRIGHTNESS	●	●	To adjust the brightness and contrast of the screen
	CONTRAST	●	●	
COLOUR ADJUSTMENT	PRESET	9300K	●	To customize the colour of the screen
		6500K	●	
	R/G/B(User Colour)	●		
IMAGE POSITION	V POSITION	●		To adjust the position of the screen
	H POSITION	●		
TRACKING	AUTO	●		To improve the clarity and stability of the screen
	CLOCK	●		
	PHASE	●		
AUDIO	MUTE	●	●	To adjust the audio function
	VOLUME	●	●	
	BBE EFFECT	●	●	
	AVL	●	●	
	SSM	●	●	
	BASS	●	●	
	TREBLE	●	●	
SETUP	LANGUAGE	●	●	To customize the screen status for a user's operating environment
	IMAGE SIZE	●	●	
	OSD POSITION	●	●	
	TRANSPARENCY	●	●	
	ZOOM	●	●	
PIP/POP	PIP MODE	●	●	To adjust the PIP/POP of the screen
	POP MODE	●	●	
● : Adjustable A : Analog Input D : Digital Input				

On Screen Display(OSD) Selection and Adjustment

Menu Item - VCR/DVD/TV/HDTV					
Menu Item	Sub-menu	V	H	T	Reference
STATION	PROGRAMME			●	To select the TV channel settings and adjust the channel quality.
	SYSTEM			●	
	SELECT			●	
	CHANNEL			●	
	FINE TUNE			●	
	NAME			●	
	AUTO PR.			●	
ADJUSTMENT	PSM	●	●	●	To improve the clarity and stability of the screen
	CONTRAST	●	●	●	
	BRIGHTNESS	●	●	●	
	SHARPNESS	●		●	
	COLOUR	●	●	●	
	TINT	●	●		
AUDIO	MUTE	●	●	●	To adjust the audio function
	VOLUME	●	●	●	
	BBE EFFECT	●	●	●	
	AVL	●	●	●	
	SSM	●	●	●	
	BASS	●	●	●	
	TREBLE	●	●	●	
SETUP	LANGUAGE	●	●	●	To customize the screen status for a user's operating environment
	IMAGE SIZE	●	●	●	
	OSD POSITION	●	●	●	
	TRANSPARENCY	●	●	●	
	COLOUR	●	●	●	
PIP/POP	PIP MODE	●	●	●	To adjust the PIP/POP of the screen
	POP MODE	●	●	●	

● : Adjustable V : VCR/DVD T : TV H : HDTV



You were introduced to the procedure of selecting and adjusting an item using the OSD system. Listed below are the icons, icon names, and icon descriptions of the all items shown on the Menu.

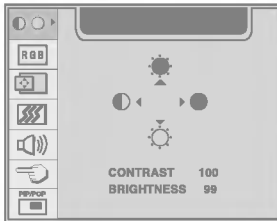

BRIGHTNESS

To adjust the brightness of the screen.



CONTRAST

To adjust the contrast of the screen.

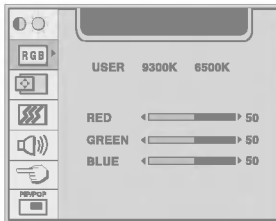

USER

RED/GREEN/BLUE

Set your own colour levels.

9300K **6500K**

Select the screen colour.

- 9300K: Slightly bluish white.
- 6500K: Slightly reddish white.

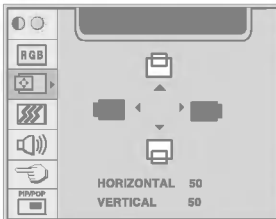

Horizontal Position

To move image left and right.



Vertical Position

To move image up and down.



On Screen Display(OSD) Selection and Adjustment

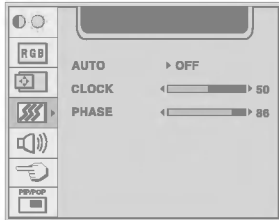

AUTO This function is suitable for analog signal input only. This button is for the automatic adjustment of the screen position, clock and phase.

CLOCK To minimize any vertical bars or stripes visible on the screen background. The horizontal screen size will also change.

PHASE To adjust the focus of the display. This item allows you to remove any horizontal noise and clear or sharpen the image of characters.

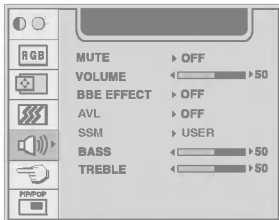

MUTE Used to select mute on (means sound off) and mute off (means sound on).

VOLUME To decrease or increase volume level.

BBE EFFECT To improve the clarity and distinction of audio quality.

AVL Use this function to automatically adjust volume being relayed unevenly for each channel or signal so that the most appropriate level can be selected.

SSM Select a sound mode of your choice among FLAT, MUSIC, MOVIE and SPEECH, or select 'USER' and adjust the values of BASS and TREBLE.

BASS To decrease or increase bass level.

TREBLE To decrease or increase treble level.



LANGUAGE To choose the language in which the control names are displayed.

IMAGE SIZE To select the image size of the screen. FULL/4:3/ SPECTACLE /1:1/AUTO
The SPECTACLE menu is used when the resolution ratio is 4:3 (640x480, 800x600 and 1024x768)

OSD POSITION

To adjust position of the OSD window on the screen. Press the ◀ ▶ button to display the submenu for OSD POSITION.

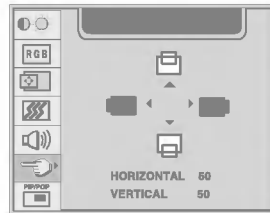

TRANSPARENCY

To adjust the transparency of the OSD menu screen.

ZOOM

To adjust horizontal and vertical image size simultaneously. If you want to move the zooming point, use the H/V POSITION function in the sub-menu. However, if the monitor turns off when zooming in and out the screen, the monitor will be returned to original screen.

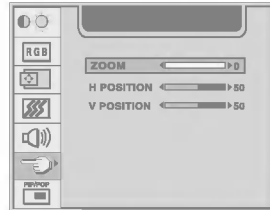

SELECT *

This menu will be enabled only when the resolution is 1280x768 @60Hz, 1024x768 @60Hz, 640x480 @70Hz or 848x480 @70Hz.

If the screen is not displayed properly, adjust the resolution as follows. If you set to the "Auto", the proper resolution will be automatically selected.

- **1280x768/1024x768/AUTO:** Use this menu when the resolution is 1280x768 @60Hz or 1024x768 @60Hz.
- **640x480/848x480/AUTO:** Use this menu when the resolution is 640x480 @70Hz or 848x480 @70Hz.

On Screen Display(OSD) Selection and Adjustment

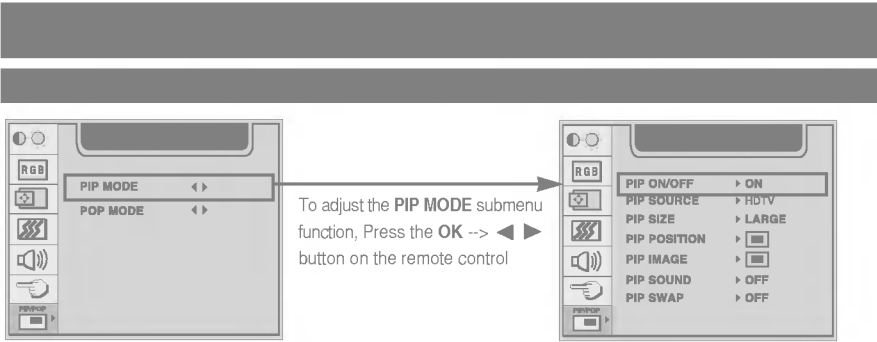

After selecting ON in the PIP ON/OFF menu, the following menu items can be adjusted.

- PIP SOURCE** To select an input signal for PIP.
- PIP SIZE** To adjust the size of the PIP screen: SMALL/LARGE
- PIP POSITION** To adjust the position of PIP screen. Press the ◀ ▶ button to display the submenu for PIP POSITION.

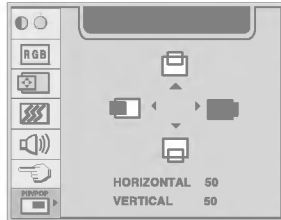

- PIP IMAGE** To adjust the image of the PIP screen; Press the ◀ ▶ button to display the submenu for PIP IMAGE. The items of the sub-menu may vary depending on the type of the source.

PSM: Select a picture mode of your choice among DYNAMIC, STANDARD, MILD and GAME, or select 'USER' and adjust the values of CONTRAST, BRIGHTNESS, SHARPNESS, COLOUR and TINT.



- CONTRAST** To adjust the contrast of the screen.
- BRIGHTNESS** To adjust the brightness of the screen.
- SHARPNESS** To adjust the clearness of the screen. In case the PIP source is HDTV, SHARPNESS is not supported.
- COLOUR** To adjust the colour to desired level.
- TINT** To adjust the tint to desired level. This function is available only in NTSC broadcasting mode.

- PIP SOUND** To turn the PIP sound on/off.
- PIP SWAP** To switch the main-screen and sub-screen in PIP mode.



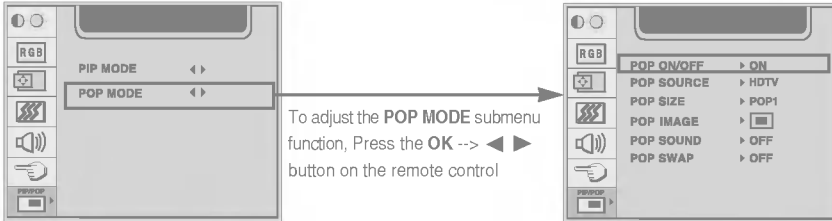

After selecting ON in the POP ON/OFF menu, the following menu items can be adjusted.

- POP SOURCE** To select an input signal for POP.
- POP SIZE** To adjust the size of the POP screen: POP1/POP2/POP3/POP4
- POP IMAGE** To adjust the image of the POP screen; Press the ◀ ▶ button to display the submenu for POP IMAGE. The items of the sub-menu may vary depending on the type of the source.
PSM : Select a picture mode of your choice among DYNAMIC, STANDARD, MILD and GAME, or select 'USER' and adjust the values of CONTRAST, BRIGHTNESS, SHARPNESS, COLOUR and TINT.



- CONTRAST** To adjust the contrast of the screen.
- BRIGHTNESS** To adjust the brightness of the screen.
- SHARPNESS** To adjust the clearness of the screen. In case the POP source is HDTV, SHARPNESS is not supported.
- COLOUR** To adjust the colour to desired level.
- TINT** To adjust the tint to desired level. This function is available only in NTSC broadcasting mode.

- POP SOUND** To turn the POP sound on/off.
- POP SWAP** To switch the main-screen and sub-screen in POP mode.

On Screen Display(OSD) Selection and Adjustment



PROGRAMME To change the channel.

SYSTEM Press the ◀ ▶ buttons to select the TV system of the country or part of the world from where you want to receive the TV channels.

SELECT To select the channel reception type. : V/UHF / CABLE

CHANNEL Press the ◀ ▶ button to select C-CH for aerial channels or S-CH for cable channels. If you know the C-(01~69) or S-channel number(01~47), enter it directly with the digit buttons 0 to 9.

FINE TUNE

In case of poor reception, you can improve the reception by fine tuning. Use the ◀ ▶ buttons to fine tune for the best picture and sound.

NAME

To see the assigned channel name.

It is possible to change the name stored in the memory or to assign a name to a TV channel which has not yet been entered. A name with up to 5 letters or numbers can be given to the programme numbers 0 to 99.

Press the ◀ ▶ buttons to move cursor to be changed. -> Press the ▼ ▲ buttons to select a character.(space, number 0~9, and alphabet A~Z) -> Press the **AUTO/SELECT** button (or **OK** button on the remote control).

AUTO PR.



To adjust the **AUTO PR.** submenu function, Press the **OK** --> ◀ ▶ button on the remote control

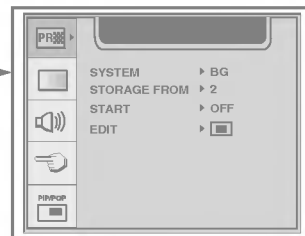

Follow these steps : Select TV system -> Select a channel number from where you want to storing for new channels. -> Press **ON** to start auto programming.

SYSTEM

Press the ◀ ▶ buttons to select the TV system of the country or part of the world from where you want to receive the TV channels.

If you want to receive 'SECAM L' channel, change the SYSTEM menu to 'L' before launching an automatic search.

STORAGE FROM

To select a channel number or enter the channel number with the number buttons from where you want to start searching for new channels. If e.g. you want to keep the channels 1 to 10 stored earlier, enter channel number 11. Your TV search for new channels from number 11 onwards.

START

Select the **ON** to start automatic programming. all available TV channels are searched for and stored automatically. To stop auto programming, press the **MENU** button.

When auto programming is completed, the programme list menu appears.

EDIT

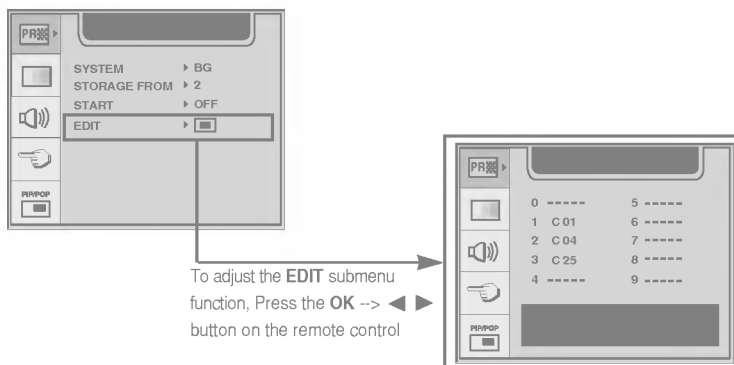

- **DELECT**: Press the ▼▲◀▶ buttons to select a TV channel to be deleted. -> Press the red key on the remote control twice. -> The selected TV channel number is deleted, all the following channels are shifted up one position.
- **COPY**: Press the ▼▲◀▶ buttons to select a TV channel to be copied. -> Press the green key on the remote control. All the following channel numbers are shifted down one position.
- **MOVE**: Press the ▼▲◀▶ buttons to select a channel number to be moved. -> Press the yellow key on the remote control. -> Press the ▼▲◀▶ buttons to move the TV channel to the desired channel number. -> Press the yellow key again to release this function.
- **SKIP**: Press the ▼▲◀▶ buttons to select a channel number to be skipped. -> Press the blue key on the remote control. The skipped TV channel is displayed in blue. -> Press the blue key again.

On Screen Display(OSD) Selection and Adjustment

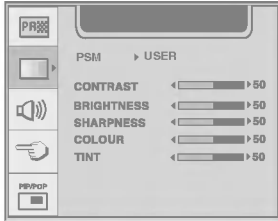

PSM Select a picture mode of your choice among DYNAMIC, STANDARD, MILD and GAME, or select 'USER' and adjust the values of CONTRAST, BRIGHTNESS, SHARPNESS, COLOUR and TINT.

CONTRAST To adjust the contrast of the screen

BRIGHTNESS To adjust the brightness of the screen.

SHARPNESS To adjust the clearness of the screen.

COLOUR To adjust the colour to desired level.

TINT To adjust the tint to desired level. This function is available only in NTSC broadcasting mode.



MUTE Used to select mute on (means sound off) and mute off (means sound on).

VOLUME To decrease or increase volume level.

BBE EFFECT To improve the clarity and distinction of audio quality.

AVL Use this function to automatically adjust volume being relayed unevenly for each channel or signal so that the most appropriate level can be selected.

SSM Select a sound mode of your choice among FLAT, MUSIC, MOVIE and SPEECH, or select 'USER' and adjust the values of BASS and TREBLE.

BASS To decrease or increase bass level.

TREBLE To decrease or increase treble level.

On Screen Display(OSD) Selection and Adjustment



LANGUAGE To choose the language in which the control names are displayed.

IMAGE SIZE To select the image size of the screen.
 FULL/4:3/ SPECTACLE /ZOOM1/ZOOM2/AUTO.
 SPECTACLE, ZOOM1, ZOOM2 and AUTO functions are useful for TV or motion pictures, but not suitable for PC environments such as computer graphics or word processing.

- FULL
You can enjoy the picture (format of 4:3) or general TV in 16:9 mode.
- 4:3
This picture format is 4 to 3 of general TV
- SPECTACLE
This function provides different areas of the screen with a varied ratio, so that the ratio at the central area is close to 4:3 and near the edges it exceeds 16:9. Since most people concentrate their focus upon the central area of the screen, they do not clearly recognize a nonlinear expansion of the image near the edges of the display. Therefore a 4:3 image can fit into the wide screen naturally.
- ZOOM 1/ZOOM 2
Zoom 1 and 2 are functions, which keeps the input ratio constant at 16:9 while zooming in; these functions, unlike conventional zoom in function, minimize the image distortion usually seen in the zooming process.
Input source can be controlled only in AV1 (SCART), AV2 (VIDEO), TV, S-VIDEO states.
- AUTO
When your set receives a wide screen signal, it will automatically change to the picture format to be sent.

Image Size / Input Source	4:3	FULL	ZOOM1	ZOOM2
16:9 Screen				

[example]

OSD POSITION

To adjust position of the OSD window on the screen. Press the ◀ ▶ button to display the submenu for OSD POSITION.

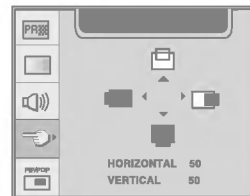

TRANSPARENCY

To adjust the transparency of the OSD menu screen.

COLOUR

To select the screen colour.

- 9300K: Slightly bluish white.
- 6500K: Slightly reddish white.

On Screen Display(OSD) Selection and Adjustment

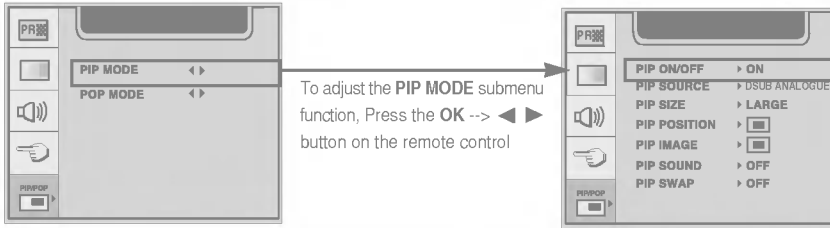

After selecting **ON** in the **PIP ON/OFF** menu, the following menu items can be adjusted.

PIP SOURCE To select an input signal for PIP.

PIP SIZE To adjust the size of the PIP screen: SMALL/LARGE

PIP POSITION To adjust the position of PIP screen. Press the ◀ ▶ button to display the submenu for PIP POSITION.

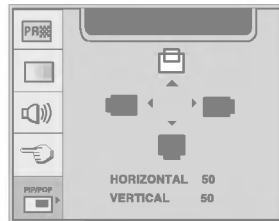

PIP IMAGE To adjust the image of the PIP screen; Press the ◀ ▶ button to display the submenu for PIP IMAGE. The items of the sub-menu may vary depending on the type of the source. In case the PIP source is D-SUB or DVI-D, PSM, COLOUR and TINT MENU are not supported.

PSM : Select a picture mode of your choice among DYNAMIC, STANDARD, MILD and GAME, or select 'USER' and adjust the values of CONTRAST, BRIGHTNESS, SHARPNESS, COLOUR and TINT.



CONTRAST To adjust the contrast of the screen.
BRIGHTNESS To adjust the brightness of the screen.
COLOUR To adjust the colour to desired level.
TINT To adjust the tint to desired level.
 This function is available only in NTSC broadcasting mode.

PIP SOUND To turn the PIP sound on/off.

PIP SWAP To switch the main-screen and sub-screen in PIP mode.

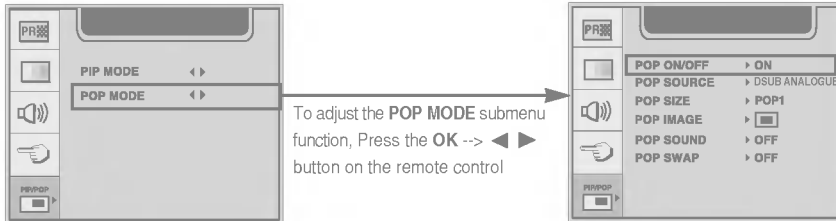

After selecting ON in the POP ON/OFF menu, the following menu items can be adjusted.

- POP SOURCE** To select an input signal for POP.
- POP SIZE** To adjust the size of the POP screen: POP1/POP2/POP3/POP4
- POP IMAGE** To adjust the image of the POP screen; Press the ◀▶ button to display the sub-menu for POP IMAGE. The items of the sub-menu may vary depending on the type of the source. In case the POP source is D-SUB or DVI-D, PSM, COLOUR and TINT MENU are not supported.

PSM : Select a picture mode of your choice among DYNAMIC, STANDARD, MILD and GAME, or select 'USER' and adjust the values of CONTRAST, BRIGHTNESS, COLOUR and TINT.



- CONTRAST** To adjust the contrast of the screen.
- BRIGHTNESS** To adjust the brightness of the screen.
- COLOUR** To adjust the colour to desired level.
- TINT** To adjust the tint to desired level. This function is available only in NTSC broadcasting mode.

- POP SOUND** To turn the POP sound on/off.
- POP SWAP** To switch the main-screen and sub-screen in POP mode.



Check the following before calling for service.

<p>● Is the power cord of the display connected?</p>	<ul style="list-style-type: none">• Check and see if the power cord is connected properly to the power outlet.
<p>● Is the power indicator light on?</p>	<ul style="list-style-type: none">• Press the Power button.
<p>● When the power is on with the power indicator lighting blue, does the screen appear dark? (Display:blue, Media station:blue)</p>	<ul style="list-style-type: none">• Adjust the brightness and the contrast.
<p>● Is the power indicator amber? (Display:amber, Media station:blue)</p>	<ul style="list-style-type: none">• If the display is in power saving mode, try moving the mouse or pressing any key on the keyboard to bring up the screen.
<p>● Do you see an "OUT OF RANGE" message on the screen?</p>	<ul style="list-style-type: none">• This message appears when the signal from the PC (video card) is out of horizontal or vertical frequency range of the display. See the 'Specifications' section of this manual and configure your display again. <p>* Max Resolution 1280 x 1024 @60Hz</p>
<p>● Does the "OUT OF RANGE" message appear when you have set the main source as HDTV?</p>	<ul style="list-style-type: none">• Check if the HDTV resolution of your set top box is set at 480i/576i. If so, reconfigure it to 576p/720p/1080i• Check if connection is being made via the D-SUB cable. If HDTV is connected via D-SUB cable, the interface method and PAL (50 Hz) are not supported. Use the HDTV port (component) instead.
<p>● Do you see a "CHECK SIGNAL CABLE " message on the screen?</p>	<ul style="list-style-type: none">• This message appears when the signal cable between your PC and your display is not connected. Check the signal cable and try again.• Press the SOURCE button on the remote control and select and input signal connected.



<ul style="list-style-type: none"> ● Display Position is incorrect. 	<ul style="list-style-type: none"> • Press the AUTO button to automatically adjust your display image to the ideal setting. If the results are unsatisfactory, adjust the image position using the H position and V position icon in the on screen display. • Check Control Panel --> Display --> Settings and see if the frequency or the resolution were changed. If yes, readjust the video card to the recommend resolution.
<ul style="list-style-type: none"> ● Display size is not correct in the PC mode. 	<ul style="list-style-type: none"> • If the resolution is 1280x768 @60Hz, 1024x768 @60Hz, 640x480 @70Hz or 848x480 @70Hz, select the SELECT menu among SETUP OSD menu to set the proper resolution. If the resolution is 1280x768 @60Hz or 1024x768 @60Hz: Select one of 1280x768/1024x768/AUTO. If the resolution is 640x480 @70Hz or 848x480 @70Hz: Select one of 640x480/848x480/AUTO.
<ul style="list-style-type: none"> ● On the screen background, vertical bars or stripes are visible. 	<ul style="list-style-type: none"> • Press the AUTO button to automatically adjust your display image to the ideal setting. If the results are unsatisfactory, decrease the vertical bars or stripes using the CLOCK icon in the on screen display.
<ul style="list-style-type: none"> ● Any horizontal noise appearing in any image or characters are not clearly portrayed. 	<ul style="list-style-type: none"> • Press the AUTO button to automatically adjust your display image to the ideal setting. If the results are unsatisfactory, decrease the horizontal bars using the PHASE icon in the on screen display. • Check Control Panel --> Display --> Settings and adjust the display to the recommended resolution or adjust the display image to the ideal setting. Set the color setting higher than 24 bits (true color).
<ul style="list-style-type: none"> ● The screen color is mono or abnormal. 	<ul style="list-style-type: none"> • Check if the signal cable is properly connected and use a screwdriver to fasten if necessary. • Make sure the video card is properly inserted in the slot. • Set the color setting higher than 24 bits (true color) at Control Panel - Settings.
<ul style="list-style-type: none"> ● The screen blinks. 	<ul style="list-style-type: none"> • Check if the screen is set to interlace mode and if yes, change it to the recommend resolution.

<ul style="list-style-type: none">● Is the H/V position not adjustable from the ZOOM function?● Has the screen size of your PC changed automatically?● Is the sound not displayed on the TV channel indication window?● In the PC signal source, is the brightness of the main screen different from that of the sub-screen?	<ul style="list-style-type: none">• Check if the ZOOM value is set at '0'. In case the ZOOM value is set at '0', the H/V position will not be adjustable.• If the IMAGE SIZE is not full-screen when you use next your PC, execute POP and it will change back to regular settings.• Check if the TV sound is set at MONO. In case the TV sound is at MONO, the sound will not be displayed.• Since the BRIGHTNESS and COLOUR of a sub-screen can be adjusted in the PIP/POP IMAGE of the PIP/POP menus, it may be different from the main screen.
---	---

<ul style="list-style-type: none">● Have you installed the display driver?● Do you see an "Unrecognized monitor, Plug&Play (VESA DDC) monitor found" message?	<ul style="list-style-type: none">• Be sure to install the display driver from the display driver CD (or diskette) that comes with your display. Or, you can also download the driver from our web site: http://www.lge.com.• Make sure to check if the video card supports Plug&Play function.
--	---

<ul style="list-style-type: none">● "IMAGE SIZE" function on OSD menu does not work?	<ul style="list-style-type: none">• Check if POP function is in use. While POP is in use, IMAGE SIZE function becomes disabled.
---	---



<ul style="list-style-type: none"> ● No sound. ● No sound in PIP /POP mode. ● Sound is too high pitched or too low pitched. ● Sound level is too low. 	<ul style="list-style-type: none"> • Check if the audio cable is correctly connected. • Check the volume level. • Check if the sound source is correctly selected. • Check if the SOUND is ON in the PIP/POP OSD menu. • Adjust the TREBLE to an appropriate level. • Adjust the BASS to an appropriate level. • Select the BBE EFFECT to an appropriate level. • Check the volume level.
---	--

<ul style="list-style-type: none"> ● Do you see “CONTROLS LOCKED” when you push MENU button? 	<ul style="list-style-type: none"> • You can secure the current control settings, so that they cannot be inadvertently changed. You can unlock the OSD controls at any time by pushing the MENU button and VOL.+ button for 5 seconds: the message “CONTROLS UNLOCKED” will appear. It is not possible to configure this function with the remote control buttons. You can only do so from the monitor.
--	---

<ul style="list-style-type: none"> ● TV signal is not received. ● Is the sound not displayed on the TV channel indication window? 	<ul style="list-style-type: none"> • Check the channel system and make sure you chose the correct channel system. • Check the AUTO CHANNEL function to automatically search the available channels. • Check and see if the TV adapter is properly connected between your display and antenna cable. • Check if the TV sound is set at ‘MONO’. In case the TV SOUND is at ‘MONO’, the sound will not be displayed.
---	--

● **Do you see a "NOT SUPPORTED" message on the screen?**

- Check the current resolution on your PC. If the resolution is higher than 1280x768, the "Zoom" function will not be supported.

Specifications

Display	23 inches (58.4cm) Flat Panel Active matrix-TFT LCD Anti-Glare coating 23 inches viewable 0.258mm pixel pitch	
Sync Input	Horizontal Freq.	30 - 66kHz (Automatic)
	Vertical Freq.	56 - 75Hz (Automatic)
	Input Form	Separate TTL, Positive/Negative Composite TTL, Positive/Negative SOG (Sync On Green) Digital
Video Input	Signal Input	15 pin D-Sub Connector DVI - D connector (Digital) Composite video S video HDTV, TV
	Input Form	RGB Analog (0.7Vp-p/75ohm), Digital, S-VIDEO, CVBS, Y Pb Pr (Y,Cb,Cr)
	Max	1280 x 1024 @60Hz
	Recommend	1280 x 768 @60Hz
Plug&Play	DDC 2B	
	Display Input	DC 24V \approx 4.0A DC 5V \approx 0.5A
	Media station Input	AC 100-240V~ 50/60Hz 1.5A
	Output	DC 24V \approx 4.0A DC 5V \approx 0.5A
	Normal	: 110W
	Stand-by/Suspend	\leq 5W
	DPMS Off	\leq 3W
	Power switch Off	\leq 3W
	Power cut-off switch off	\leq 1W
	0°~20°	
	Attached(O), Detached ()	



Specifications

Dimensions & Weight	Display (with tilt stand)	
	Width	58.75cm / 23.13 inches
	Height	44.65 cm / 17.58 inches
	Depth	26.0cm / 10.24 inches
	Net	7.70Kg / 16.98lbs
	Media Station	
	Width	12.96 cm / 5.10 inches
	Height	19.16 cm / 7.54 inches
	Depth	20.56 cm / 8.09 inches
	Net	2.7 Kg / 5.95lbs
	Operating Conditions	
	Temperature	10°C to 35 °C
Humidity	10 % to 80 % non-Condensing	
Storage Conditions		
Temperature	-20°C to 60 °C	
Humidity	5 % to 95 % non-Condensing	

.....

VESA wall mounting

Connected to another object (stand type and wall-mounted type). This monitor accepts a VESA-compliant mounting interface pad.- **optional**)

For further information, refer to the VESA Wall Mounting Instruction Guide.



Kensington Security Slot- optional

Connected to a locking cable that can be purchased separately at most computer stores



Display Modes (Resolution)

■ PC mode

1	VGA	640 x 350	31.469	70
2	VGA	640 x 480	31.469	60
3	VESA	640 x 480	37.500	75
4	VGA	720 x 400	31.468	70
5	VESA	800 x 600	37.879	60
6	VESA	800 x 600	46.875	75
7	MAC	832 x 624	49.725	75
8	VESA	1024 x 768	48.363	60
9	VESA	1024 x 768	60.123	75
10	VESA	1280 x 768	47.780	60
11	VESA	1280 x 1024	63.981	60

Signal Connector Pin Assignment

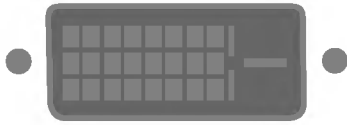

■ DVI-D Connector

1	T. M. D. S. Data2-	16	Hot Plug Detect
2	T. M. D. S. Data2+	17	T. M. D. S. Data0-
3	T. M. D. S. Data2/4 Shield	18	T. M. D. S. Data0+
4	T. M. D. S. Data4-	19	T. M. D. S. Data0/5 Shield
5	T. M. D. S. Data4+	20	T. M. D. S. Data5-
6	DDC Clock	21	T. M. D. S. Data5+
7	DDC Data	22	T. M. D. S. Clock Shield
8	Analog Vertical Sync.	23	T. M. D. S. Clock+
9	T. M. D. S. Data1-	24	T. M. D. S. Clock-
10	T. M. D. S. Data1+		
11	T. M. D. S. Data1/3 Shield		
12	T. M. D. S. Data3-		
13	T. M. D. S. Data3+		
14	+5V Power		
15	Ground (return for +5V, H. Sync. and V. Sync.)		

T. M. D. S. (Transition Minimized Differential Signaling)

Indicator

Normal	blue	blue
Stand-by/Suspend	amber	dark blue
DPMS Off	amber	dark blue
Power switch off	off	dark blue
Power cut-off switch off	off	off

Digitally yours ■■■■■.....

