





**LG**

website <http://www.lgservice.co>

# LG

## Room Air Conditioner

### ***OWNER'S MANUAL***

Prior to installation, this air-conditioning unit must be submitted for approval by the utility service which provides electricity (EN 61000-2, EN 61000-3 Norm).

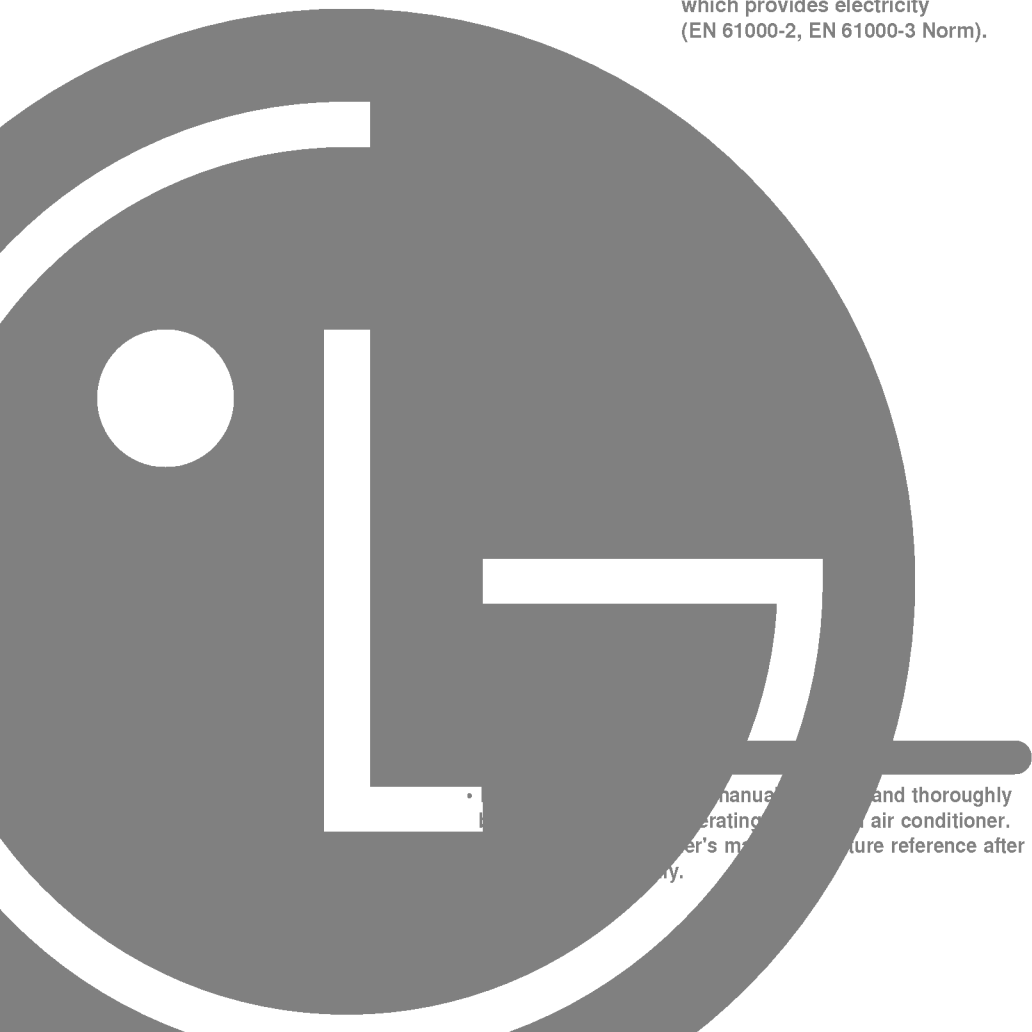

...manual and thoroughly  
operating the air conditioner.  
...er's manual for reference after  
y.



## FOR YOUR RECORDS

Write the model and serial numbers here:

**Model #** \_\_\_\_\_

**Serial #** \_\_\_\_\_

You can find them on a label on the side of each unit.

**Dealer's Name** \_\_\_\_\_

**Date Purchased** \_\_\_\_\_

- Staple your receipt to this page in the event you need it to prove date of purchase or for warranty issues.



## READ THIS MANUAL

Inside you will find many helpful hints on how to use and maintain your air conditioner properly. Just a little preventive care on your part can save you a great deal of time and money over the life of your air conditioner.

You'll find many answers to common problems in the chart of troubleshooting tips. If you review our chart of

**Troubleshooting Tips** first, you may not need to call for service at all.



## PRECAUTION

- Contact the authorized service technician for repair or maintenance of this unit.
- Contact the installer for installation of this unit.
- The air conditioner is not intended for use by young children or invalids without supervision.
- Young children should be supervised to ensure that they do not play with the air conditioner.
- When the power cord is to be replaced, replacement work shall be performed by authorized personnel only using only genuine replacement parts.
- Installation work must be performed in accordance with the National Electric Code by qualified and authorized personnel only.



To prevent injury to the user or other people and property damage, the following instructions must be followed.

- Incorrect operation due to ignoring instruction will cause harm or damage. The seriousness is classified by the following indications.

**⚠ WARNING** This symbol indicates the possibility of death or serious injury.

**⚠ CAUTION** This symbol indicates the possibility of injury or damage to properties only.

- Meanings of symbols used in this manual are as shown below.

	<b>Be sure not to do.</b>
	<b>Be sure to follow the instruction.</b>

**⚠ WARNING**

■ **Installation**



- Otherwise, it will cause electric shock or fire due to heat generation or electric shock.

**Do not damage or use an unspecified power cord.**

- It will cause electric shock or fire.
- In the supply cord is damaged, it must be replaced by the manufacturer or its service agent or a similarly qualified person in order to avoid a hazard. (Y Attachment)

**Do not modify power cord length or share the outlet with other appliances.**

- It will cause electric shock or fire due to heat generation.



- No grounding may cause electric shock.

**Always install air leakage breaker and a dedicated switching board.**

- No installation may cause fire and electric shock accident.

**Do not use the socket if it is loose or damaged.**

- It may cause fire and electric shock.



- It may cause fire.

## ■ Operation

---

**Do not operate or stop the unit by inserting or pulling out the power plug.**

- It will cause electric shock or fire due to heat generation.



- It may cause failure of machine or electric shock.

**Do not operate with wet hands or in damp environment.**

- It may cause electric shock.



- This could damage your health.

**Unplug the unit if strange sounds, smell, or smoke comes from it.**

- It may cause fire and electric shock accident.



- It may cause electric shock.

**Do not use the power cord close to the heating tools.**

- It may cause fire and electric shock.

**Do not use the power cord near flammable gas or combustibles, such as gasoline, benzene, thinner, etc.**

- It may cause an explosion or fire.

**Ventilate before operating air conditioner when gas goes out.**

- It may cause explosion, fire and, burn.

**Do not disassemble or modify products randomly.**

- It may cause failure and electric shock.

---

---

 **CAUTION**

---

---

## ■ Installation

---

**Ensure that an installation console of the outdoor appliance is not damaged due to the use for a long time.**

- If leaving appliance damaged, there is concern of damage due to the falling of product.

**Use caution when unpacking and installing. Sharp edges could cause injury.**

## ■ Operation

**Never touch the metal parts of the unit when removing the filter.**

- They are sharp and may cause injury.

**Ventilate well when used together with a stove, etc.**

- An oxygen shortage may occur.

**Do not put a pet or house plant where it will be exposed to direct air flow.**

- This could injure the pet or plant.

**Stop operation and close the window in storm or hurricane.**

- Operation with windows opened may cause wetting of indoor and soaking of household furniture.

**Turn off the main power switch when not using it for a long time.**

- It may cause failure of product or fire.

**Always insert the filters securely. Clean it once every two weeks.**

- Operation without filters may cause failure.

**Do not place heavy object on the power cord and take care so that the cord should not be pressed.**

- There is danger of fire or electric shock.

**If water enters the product, turn the power switch of the main body of appliance off. After taking the power-plug out from the socket, contact with the service center.**



- Water may enter the unit and degrade the insulation. It may cause an electric shock.

**When cleaning the unit, first make sure the power and breaker are turned off.**

- Since the fan rotates at high speed during operation, it may cause injury.

**Do not use appliance for special purpose such as animals or vegetables, precision machine, or conservation of art articles.**

- It may cause damage of animals or vegetables or loss of property.

**Hold the plug by the head of the power plug when taking it out.**

- It may cause electric shock and damage.

**Do not place obstacles around the absorption inlet or instead of blowing-out inlet.**

- It may cause failure of appliance or accident.

**Do not use strong detergent such as wax or thinner but use a soft cloth.**

- Appearance may be deteriorated due to change of product color or scratching of its surface.

**Do not drink water drained from air conditioner.**

- It contains contaminants and will make you sick.

1. Contact an installation specialist for installation.
2. Plug in the power plug properly.
3. Use a dedicated circuit.
4. Do not use an extension cord.
5. Do not start/stop operation by plugging/unplugging the power cord.
6. If the cord/plug is damaged, replace it with only an authorized replacement part.

1. Being exposed to direct airflow for an extended period of time could be hazardous to your health. Do not expose occupants, pets, or plants to direct airflow for extended periods of time.
2. Due to the possibility of oxygen deficiency, ventilate the room when used together with stoves or other heating devices.
3. Do not use this air conditioner for non-specified special purposes (e.g. preserving precision devices, food, pets, plants, and art objects). Such usage could damage the items.

1. Do not touch the metal parts of the unit when removing the filter. Injuries can occur when handling sharp metal edges.
2. Do not use water to clean inside the air conditioner. Exposure to water can destroy the insulation, leading to possible electric shock.
3. When cleaning the unit, first make sure that the power and breaker are turned off. The fan rotates at a very high speed during operation. There is a possibility of injury if the unit's power is accidentally triggered on while cleaning inner parts of the unit.

For repair and maintenance, contact your authorized service dealer.



**This symbol alerts you to the risk of electric shock.**



**This symbol alerts you to hazards that could cause harm to the air conditioner.**



**This symbol indicates special notes.**

1. Remove the battery cover by pulling it according to the arrow direction.
2. Insert new batteries making sure that the (+) and (-) of battery are installed correctly.
3. Reattach the cover by sliding it back into position.

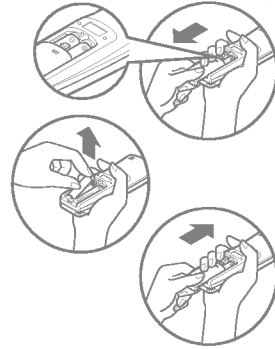

Use 2 AAA(1.5volt) batteries.

Do not use rechargeable batteries.

## Storage and Tips For Using the Remote Control

- The remote control may be stored mounted on a wall.
- To operate the room air conditioner, aim the remote control at the signal receptor.

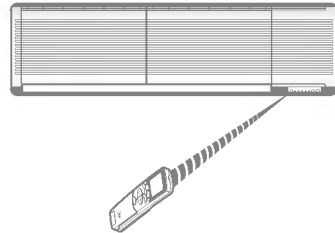
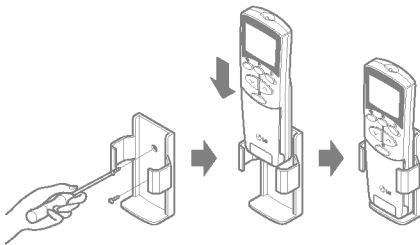

## Signal Receptor

Receives the signals from the remote control.(Signal receiving sound: two short beeps or one long beep.)

## Operation Indication Lamps



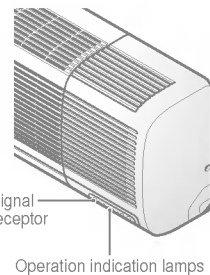





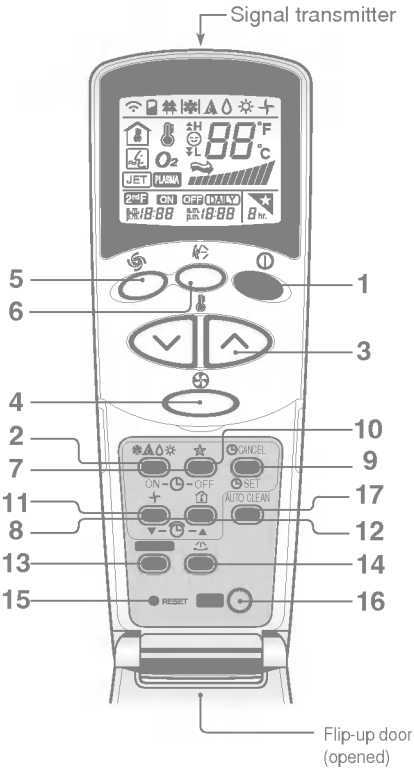







- Ⓛ On/Off : Lights up during the system operation.
- 🕒 Timer or Sleep Mode : Lights up during Timer operation or Sleep mode.
- ❄️ Defrost Mode : Lights up during Defrost Mode or Hot Start operation (Heat pump model only)
- OUT DOOR Outdoor unit operation : Lights up during outdoor unit operation. (Cooling model only)
- PLASMA Plasma Mode : Lights up during plasma-purification operation. (option)
- Auto Restart Mode : Lights up during if Restart Button is pressed.
- RESTART Auto Restart Button : In failure of electric power, if the button is pressed the unit runs as previous setting operation when power returns.
- POWER Forced Operation Button : Operation starts, when this button is pressed and stops when you press the button again.





The remote control transmits the signals to the system.



- 1. START/STOP BUTTON**  
 Operation starts when this button is pressed and stops when the button is pressed again.
 
- 2. OPERATION MODE SELECTION BUTTON**  
 Used to select the operation mode.
 
- 3. ROOM TEMPERATURE SETTING BUTTONS**  
 Used to select the room temperature.
 
- 4. INDOOR FAN SPEED SELECTOR**  
 Used to select fan speed in four steps low, medium, high and CHAOS.
 
- 5. JET COOL**  
 Used to start or stop the speed cooling. (Speed cooling operates super high fan speed in cooling mode.)
 
- 6. CHAOS SWING BUTTON**  
 Used to stop or start louver movement and set the desired up/down airflow direction.
 
- 7. ON/OFF TIMER BUTTONS**  
 Used to set the time of starting and stopping operation. (See page 17)
 
- 8. TIME SETTING BUTTONS**  
 Used to adjust the time. (See page 17)
 
- 9. TIMER SET/CANCEL BUTTON**  
 Used to set the time when the desired time is obtained and to cancel the Timer operation. (See page 17)
 
- 10. SLEEP MODE AUTO BUTTON**  
 Used to set Sleep Mode Auto operation. (See page 17)
 
- 11. AIR CIRCULATION BUTTON**  
 Used to circulate the room air without cooling or heating. (See page 18)
 
- 12. ROOM TEMPERATURE CHECKING BUTTON**  
 Used to check the room temperature.
 
- 13. PLASMA(OPTIONAL)**  
 Used to start or stop the plasma-purification function. (See page 15)
 
- 14. HORIZONTAL AIRFLOW DIRECTION CONTROL BUTTON (NOT ON ALL MODELS)**  
 Used to set the desired horizontal airflow direction. (See page 18)
 
- 15. RESET BUTTON**  
 Used prior to resetting time or after replacing batteries.
 
- 16. 2nd F Button**  
 Used prior to using modes printed in blue at the bottom of buttons. (See page 16)
 
- 17. AUTO CLEAN(OPTIONAL)**  
 Used to set Auto Clean mode.
 

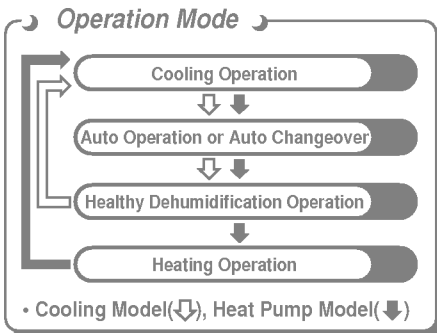

## Cooling Operation

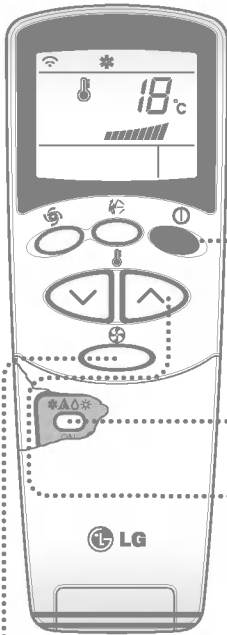

- 1** Press the Start/Stop button. The unit will respond with a beep.



- 2** Open the door on the remote control. To select **Cooling Operation**, press the Operation Mode Selection button. Each time the button is pressed, the operation mode is shifted in the direction of the arrow.

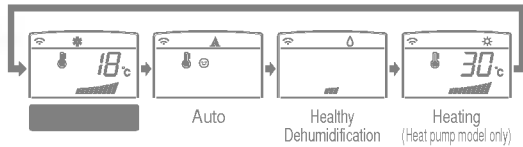

- 3** Close the door on the remote control. Set the temperature lower than the room temperature. The temperature can be set within a range of 18°C~30°C in 1°C increments.

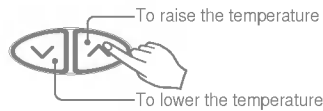

- 4** Set the fan speed again with the door of the remote control still closed. You can select the fan speed in four steps—low, medium, high and CHAOS. Each time the button is pressed, the fan speed mode is shifted.



### **Natural wind by the CHAOS logic**

- For more fresh feeling than other fan speed, press the Indoor Fan Speed Selector and set to CHAOS mode. In this mode, the wind blows like natural breeze by automatically changing fan speed according to the CHAOS logic.

## Auto Operation(Optional)

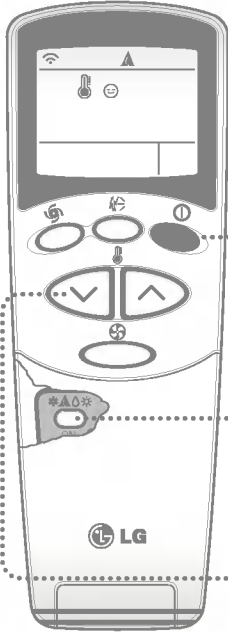

**1** Press the Start/Stop button.  
The unit will respond with a beep.



**2** Open the door on the remote control. To select **Auto Operation**, press the Operation Mode Selection button. Each time the button is pressed, the operation mode is shifted in the direction of the arrow.

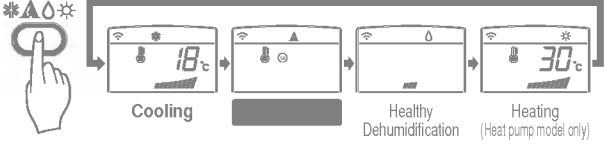

**3** The temperature and fan speed are automatically set by the electronic controls based on the actual room temperature. If you want to change the set temperature, press the Room Temperature Setting buttons. The cooler or warmer you feel, the more times (up to two times) you should press the button. The set temperature will be changed automatically.

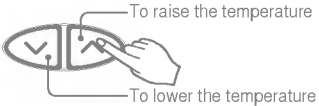

**During Auto Operation:**

- You cannot switch the indoor fan speed. It has already been set by the Fuzzy rule.
- If the system is not operating as desired, manually switch to another mode. The system will not automatically switch from the cooling mode to the heating mode, or from heating mode to cooling mode, it must be done by manually resetting.
- During Auto Operation, pressing the chaos swing button makes the horizontal louvers swing up and down automatically. If you want to stop auto-swing, press the chaos swing button again.



## Auto Changeover Operation(Optional)

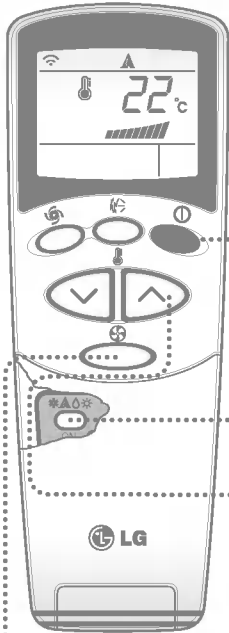

- 1** Press the Start/Stop button.  
The unit will respond with a beep.



- 2** Open the door on the remote control. To select **Auto Changeover Operation**, press the Operation Mode Selection button. Each time the button is pressed, the operation mode is shifted in the direction of the arrow.

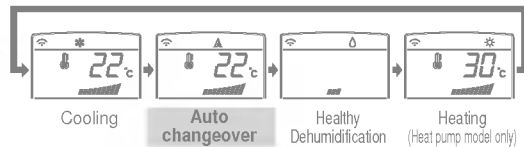

- 3** Close the door on the remote control. Set the temperature lower than the room temperature. The temperature can be set within a range of 18°C~30°C in 1°C increments.

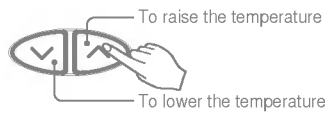

- 4** Set the fan speed again with the door of the remote control still closed. You can select the fan speed in four steps—low, medium, high and CHAOS. Each time the button is pressed, the fan speed mode is shifted.



### During Auto changeover Operation:

The air conditioner changes the operation mode automatically to keep indoor temperature. When room temperature vary over  $\pm 2^{\circ}\text{C}$  with respect to setting temperature, air conditioner keeps the room temperature in  $\pm 2^{\circ}\text{C}$  with respect to setting temperature by auto changeover mode.



## Healthy Dehumidification Operation

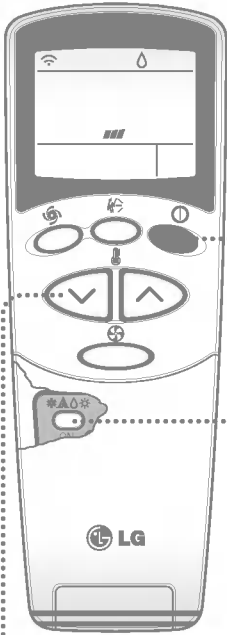

**1** Press the Start/Stop button. The unit will respond with a beep.



**2** Open the door on the remote control. To select **Healthy Dehumidification Operation**, press the Operation Mode Selection button. Each time the button is pressed, the operation mode is shifted in the direction of the arrow.

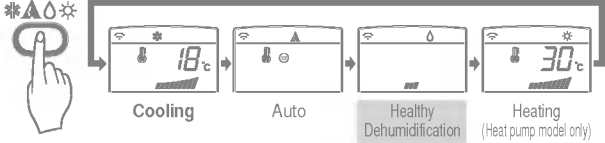

**3** Set the fan speed again with the door of the remote control still closed. You can select the fan speed in four steps—low, medium, high, or CHAOS. Each time the button is pressed, the fan speed mode is shifted.



**Natural wind by the CHAOS logic**

- For more fresh feeling than other fan speed, press the Indoor Fan Speed Selector and set to CHAOS mode. In this mode, the wind blows like natural breeze by automatically changing fan speed according to the CHAOS logic.

**During Healthy Dehumidification Operation:**

- If you select the dehumidification mode on the operation selection button, the A/C starts to run the dehumidification function. It automatically sets the room temp. and airflow volume to the best condition for dehumidification, based on the sensed current room temp.

In this case, however, the setting temp. is not displayed in the remote control and you are not able to control the room temp. either.

- During the healthy dehumidification function, the airflow volume is automatically set according to the optimization algorithm responding to the current room temp. status which makes the room condition healthy and comfortable even in the high humidity season.



## Heating Operation(Heat pump model only)

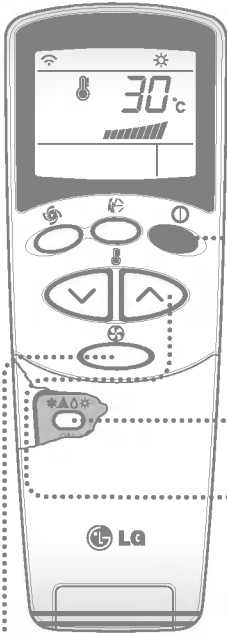

**1** Press the Start/Stop button. The unit will respond with a beep.



**2** Open the door on the remote control. To select **Heating Operation**, press the Operation Mode Selection button. Each time the button is pressed, the operation mode is shifted in the direction of the arrow.

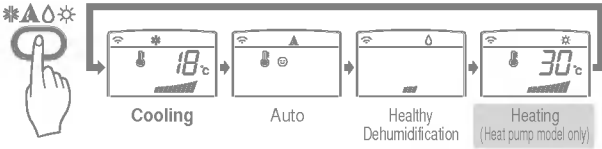

**3** Close the door on the remote control. Set the temperature higher than the room temperature. The temperature can be set within a range of 16°C~30°C in 1°C increments.

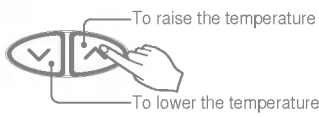

**4** Set the fan speed again with the door of the remote control still closed. You can select the fan speed in four steps—low, medium, high and CHAOS. Each time the button is pressed, the fan speed mode is shifted.

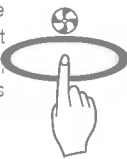

### Natural wind by the CHAOS logic

- For more fresh feeling than other fan speed, press the Indoor Fan Speed Selector and set to CHAOS mode. In this mode, the wind blows like natural breeze by automatically changing fan speed according to the CHAOS logic.



## Jet Cool Operation

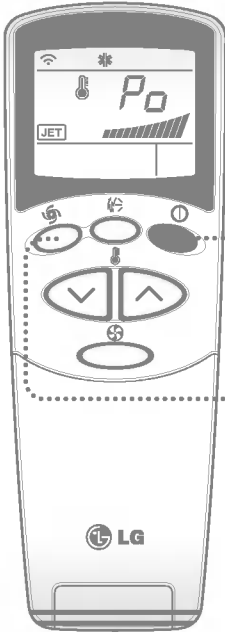

- 1 Press the Start/Stop button.  
The unit will respond with a beep.



- 2 Press the **Jet Cool** button to operate the speed cooling mode and the unit will operate in super high fan speed on cooling mode for 30 minutes.



- 3 To cancel the **Jet Cool** mode, press the **Jet Cool** button or the fan speed button or the room temperature setting button again and the unit will operate in high fan speed on cooling mode.

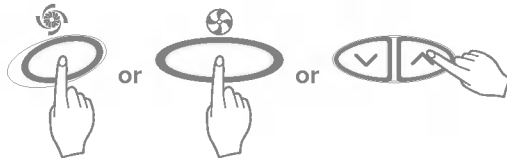

□ During the JET COOL function at any moment, the A/C starts to blow the cool air at extremely high speed for 30 minutes setting the room temp. automatically to 18°C. It is especially used to cool the room temp. in the shortest time in a hot summer.

In heat pump mode or neuro fuzzy mode, however, the JET COOL function is not available.

□ In order to return to the normal cooling mode from the JET COOL mode, you just press either the operation mode selection button, airflow volume selection or temp. setting button or the JET COOL button again.



## PLASMA Purification Operation(Optional)

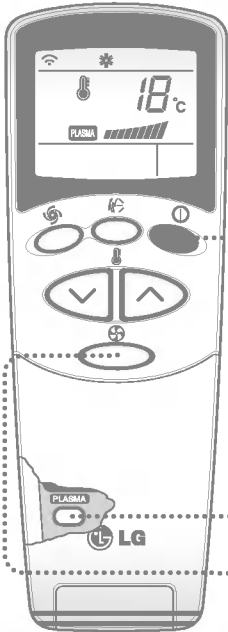

- 1** Press the Start/Stop button.  
The unit will respond with a beep.



- 2** Open the door on the remote control.  
Press the PLASMA air purifying operation ON/OFF button.  
Operation will start when the button is pressed and stop when the button is pressed again.





- 3** Set the fan speed again with door of the remote control closed. You can select the fan speed in four steps-low, medium, high or CHAOS.  
Each time the button is pressed, the fan speed mode is shifted.

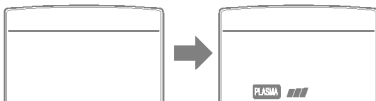

\* Air purifying operation (PLASMA) can be with cooling, Heating or any other operations.

### PLASMA Air Purifying Operation only



If you press the only PLASMA button, only PLASMA air purifying operates.  
Then, fan speed is low. You can select the fan speed in four steps-low, medium, high or CHAOS.  
Each time the button (  ) is pressed, the fan speed mode is shifted.



## 2<sup>nd</sup>F 2nd F Operation

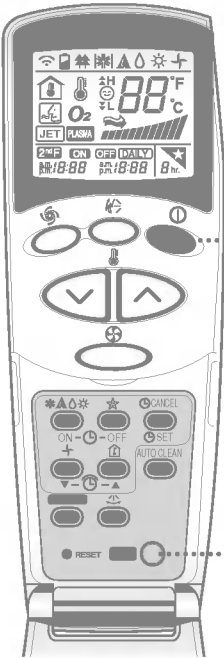

**1** Press the Start/Stop button.  
The unit will respond with a beep.

**2** Open the door of the remote control and press the 2nd Function button to operate functions printed in blue at bottom of buttons.  
(Check the indication of 2nd function on remote control display.)  
These buttons operate the timer setting as follows:

**3** 2nd function goes off in a short time automatically or when the button is pressed again.

*For more details, refer to functions next page.*

## Auto -Clean(Optional)

**AUTO CLEAN**



1. Whenever you press the Auto Clean button, Auto Clean Function will be reserved and cancelled.
2. Auto Clean function works before and after cooling or dehumidification mode. For details, refer to the below points.
3. When the unit is started after the reservation of Auto Clean ,the Cool Start function operates and indoor Fan is started after 20 seconds.
4. When you press Start/Stop button to turn off the unit after the you have reserved Auto Clean function, the air-conditioner circulates the indoor air in the Auto Clean mode with no more Cooling or Dehumidification operation.  
For Cooling only model, it lasts for 30 minutes for Heat pump model, for 16 minutes.
5. If you press the auto clean button again during the product operation , Auto Clean function will be cancelled.

This function is to remove unpleasant smells from mold and other bacteria in the air-conditioner, and to remove humidity automatically during humidly summer, which supplies the indoor with purified air.



## Sleep Mode

1. Press the Sleep Mode Auto button to set the time you want the unit to turn off automatically.
2. The Timer is programmed in one-hour increments by pressing the Sleep Mode Auto button 1 to 7 times. The sleep mode is available for 1 to 7 times. To alter the time period in steps of 1 hour, press the Sleep Mode Button while aiming at air conditioner.
3. Make sure the Sleep Mode Auto LED lights up.



To cancel the Sleep Mode, press the sleep Mode Auto button several times until the star (★) disappears from the operation display.

**■** *The Sleep Mode will be operated at slow fan speed (cooling) or medium fan speed (heat pump only) for quiet sleeping.*

IN COOLING MODE OR HEALTHY DEHUMIDIFICATION MODE:

The temperature will automatically rise by 1°C over the next 30 minutes and by 2°C in 1 hour for comfortable sleeping.



## Setting the Time

Time can be set only when you have pressed the Reset button. If you have just replaced the batteries, the Reset button should be pressed to reset the time.

1. Press the Start/Stop button.



2. Press 2nd F button and check if 2nd F icon is on.



3. Press the Time Setting buttons until the desired time is set.



4. Press the Timer SET button.



**■** *Check the indicator for A.M. and P.M.*



## Delay Start/Pre-Set Stop

1. Make sure the time is set correctly on the remote control display.

2. Press 2nd F button.



3. Press the ON/OFF Timer buttons to turn Timer on or off.



4. Press the Time Setting buttons until the desired time is set.



5. To set the selected time, press the Timer SET button while aiming the remote control at the signal receptor.



### To cancel the timer setting

Check if 2nd F icon is off. Press the Timer Cancel button while aiming remote control at the signal receptor. (The timer lamp on the air conditioner and the display will go out.)



**■** *Select one of the following four types of operation.*

with the unit running



Delay OFF Timer



Delay ON Timer



Delay OFF and ON Timer



Delay ON and OFF Timer



## Vertical Airflow Direction Control

The up/down airflow (Vertical Airflow) can be adjusted by using the remote control.

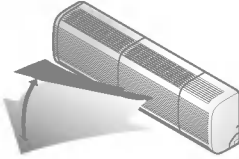

1. Press the Start/Stop button to start the unit.
2. Open the door on the remote control. Press Chaos Swing button and the louvers will swing up and down. Press the Chaos Swing button again to set the vertical louver at the desired airflow direction.



- If you press the CHAOS swing button, the horizontal airflow direction is changed automatically based on the CHAOS algorithm to distribute the air in the room evenly and at the same time to make the human body feel most comfortable, as if enjoying a natural breeze.
- Always use the remote control to adjust the up/down airflow direction. Manually moving the vertical airflow direction louver by hand could damage the air conditioner.
- When the unit is shut off, the up/down airflow direction louver will close the air outlet vent of the system.

### To adjust left/right(Horizontal Airflow) direction

**CAUTION : Ensure unit is turned off before adjusting the horizontal airflow direction control.**  
Carefully open vertical louver to allow access to the horizontal airflow direction.

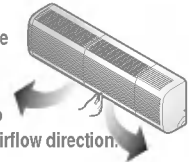

Adjust the left/right airflow direction by hand.



## Horizontal Airflow Direction Control (Optional)

The left/right(Horizontal Airflow) can be adjusted by using the remote control. Press the Start/Stop button to start the unit.

Open the door on the remote control. Press the Airflow Direction Start/Stop button and the louvers will swing left and right. Press the Horizontal Airflow Direction Control Button again to set the horizontal louver at the desired airflow direction.

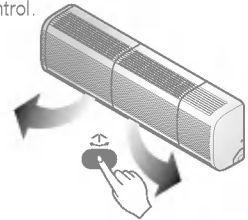

## Air Circulation Mode

Circulates the room air without cooling or heating.

1. Press the Start/Stop button. the unit will respond with a beep.
2. Open the door on the remote control. Press the Air Circulation button. Close the door on the remote control. Now each time that you press the Indoor Fan Speed Selector, the fan speed is shifted from low to CHAOS and back to low again.

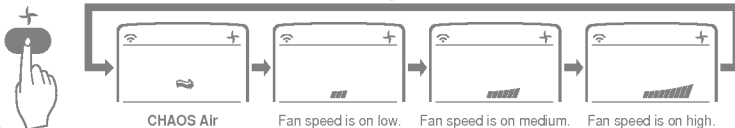

- CHAOS Air** economizes power consumption and prevents overcooling. The fan speed is automatically changed from high to low or vice versa, depending on the ambient temperature.

## The Button Operation

### FORCED OPERATION

The operation will be started if the power button is pressed.  
If you want to stop operation, re-press the button.

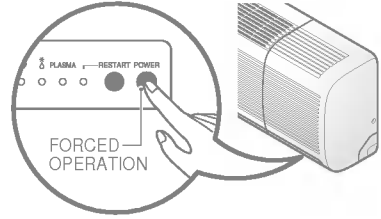

	Cooling Model	Heat pump Model		
		Room Temp. $\geq 24^{\circ}\text{C}$	$21^{\circ}\text{C} \leq$ Room Temp. $< 24^{\circ}\text{C}$	Room Temp. $< 21^{\circ}\text{C}$
Operating mode	Cooling	Cooling	Healthy Dehumidification	Heating
Indoor FAN Speed	High	High	Healthy Dehumidification Rule	High
Setting Temperature	22°C	22°C	23°C	24°C

## Auto restart

In case the power comes on again after a power failure, Auto Restarting Operation is the function to operate procedures automatically to the previous operating conditions.  
If you want to use this operation, press the Auto Restart Button.

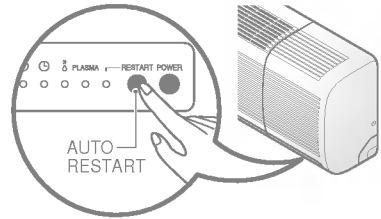

### Helpful information

Fan speed and cooling capacity.  
The cooling capacity indicated in the specification is the value when the fan speed is set to high, and the capacity will be lower at low or medium fan speed.  
High fan speed is recommended when you wish to cool the room quickly.

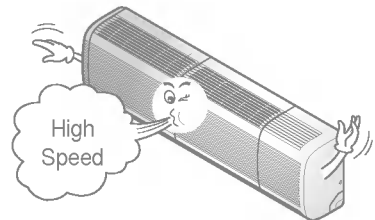

**CAUTION:** Before performing any maintenance, turn off the main power to the system.

### Grille, Case, and Remote Control

- Turn the system off before cleaning. To clean, wipe with a soft, dry cloth. Do not use bleach or abrasives.

Supply power must be disconnected before cleaning the indoor unit.

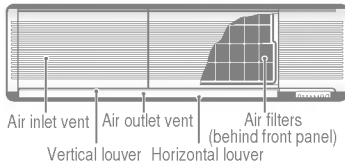

### AIR FILTER

The air filters behind the front grille should be checked and cleaned once every 2 weeks or more often if necessary.

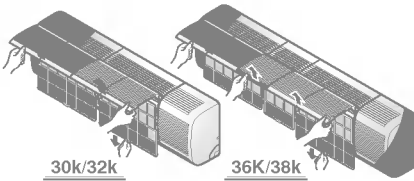

### NANO PLASMA FILTER, TRIPLE DEODORIZING FILTER(OPTIONAL)

The PLASMA filter behind the air filters should be checked and cleaned once in every 3 months or more often if necessary.

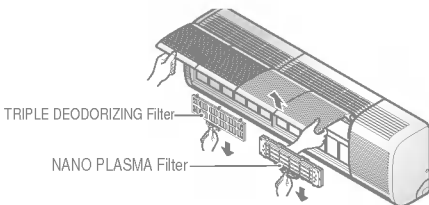

- Never use any of the followings:

- Water hotter than 40 °C  
Could cause deformation and/or discoloration.
- Volatile substances  
Could damage the surfaces of the air conditioner.

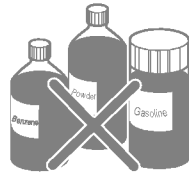

1. Lift the front access panel and pull the filter tab slightly forward to remove the filter.
2. Clean the filter with a vacuum or warm, soapy water.
  - If dirt is conspicuous, wash with a solution of detergent in lukewarm water.
  - If hot water (40 °C or more) is used, it may be deformed.
3. After washing with water, dry well in the shade.
4. Re-install the air filter.

1. After removing the air filters, pull slightly forward to remove the NANO PLASMA filter.
2. Remove dust with vacuum cleaner or air. (You should not try to wash with water).
3. Note the cuts of electric discharge lines.
4. Re-install the NANO PLASMA filter to the original position.

1. After removing the air filters, pull slightly forward to remove the TRIPLE DEODORIZING filter.
2. Dry in the sunlight for two hours.
3. Re-install the TRIPLE DEODORIZING filter to the original position.



Don't touch this PLASMA Filter within 10 seconds after opening the inlet grille, it may cause an electric shock.

## Replacement of Purifying Filter (Option)

• Recommended use period : About 2 years

1. Open front panel and remove air filters.
2. Remove air purifying filters.

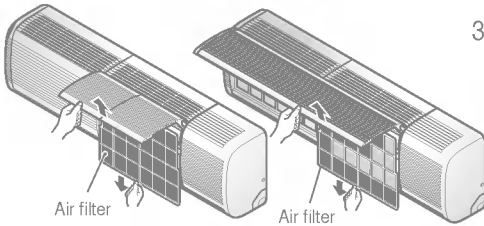

4. Reinsert air filters and close front panel.

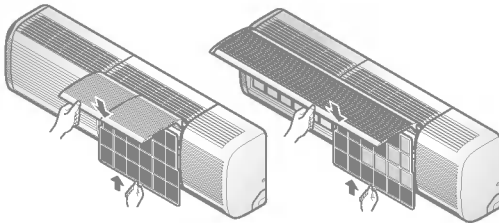

3. Insert new air purifying filters.

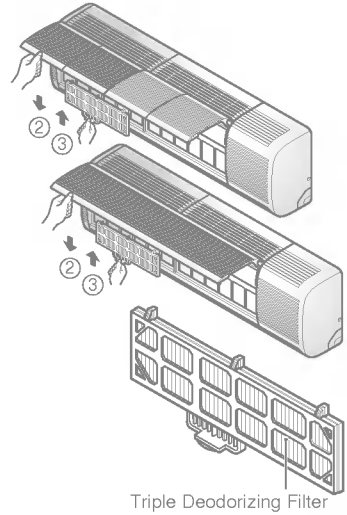

The heat exchanger coils and panel vents of the outdoor unit should be checked regularly. If clogged with dirt or soot, the heat exchanger and panel vents may be professionally steam cleaned.

*Dirty or dogged coils will reduce the operating efficiency of the system and cause higher operating costs.*

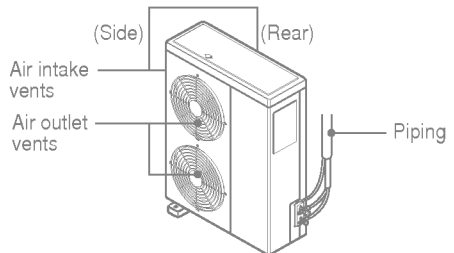
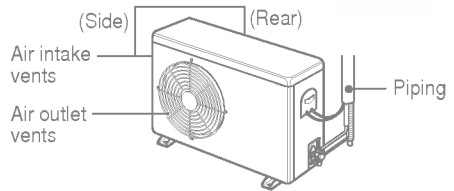

## When air conditioner is not going to be used for a long time.

1. Operate the air conditioner on Air circulation mode (Refer to page 18) for 2 to 3 hours.
  - This will dry out the internal mechanisms.
2. Turn off the circuit breaker, and disconnect the plug.



**CAUTION Turn off the circuit breaker when the air conditioner is not going to be used for a long time.**

Dirt may collect and may cause a fire.

3. Remove the batteries from the remote control.

## When the air conditioner is to be used again.

1. Clean the air filter and install it in the indoor unit.(Refer to page 20 for cleaning filters.)
2. Check that the air inlet and outlet of the indoor/outdoor unit are not blocked.

This is not good for your health and wastes electricity.

**Keep blinds or curtains closed.**

Do not let direct sunshine enter the room when the air conditioner is in operation.

**Keep the room temperature uniform.**

Adjust the vertical and horizontal airflow direction to ensure a uniform temperature in the room.

**Make sure that the doors and windows are shut tight.**

Avoid opening doors and windows as much as possible to keep the cool air in the room.

Blockages in the air filter reduce the airflow and lower cooling and dehumidifying effects. Clean at least once every two weeks.

**Ventilate the room occasionally.**

Since windows are kept closed, it is a good idea to open them and ventilate the room now and then.

Check the following points before requesting repairs or service.... If the fault persists, please contact your dealer or service center.

Case	Explanation	See page
The air conditioner does not operate.	• Have you made a mistake in timer operation?	17
	• Has the fuse blown or has the circuit breaker been tripped?	-
The room has a peculiar odor.	• Check that this is not a damp smell exuded by the walls, carpet, furniture, or cloth items in the room.	-
It seems that condensation is leaking from the air conditioner.	• Condensation occurs when the airflow from the air conditioner cools the warm room air.	-
Air conditioner does not operate for about 3 minutes when restarted.	• This is the protector of the mechanism. • Wait about three minutes and operation will begin.	-
Does not cool or heat effectively.	• Is the air filter dirty? See air filter cleaning instructions.	20
	• Has the temperature been set incorrectly?	10, 14
	• Are the indoor unit's air inlet or outlet vents obstructed?	-
The air conditioner operation is noisy.	• For a noise that sounds like water flowing. -This is the sound of freon flowing inside the air conditioner unit. • For a noise that sounds like the compressed air releasing into atmosphere. -This is the sound of the dehumidifying water being processed inside the air conditioning unit.	-
Remote control display is faint, or no display at all.	• Are the batteries depleted? • Are the batteries inserted in the opposite (+) and (-) directions?	7
Crack sound is heard.	• This sound is generated by the expansion/constriction of the front panel, etc. due to changes of temperature.	-