



VCD Mini Hi-Fi System

Owner's Manual

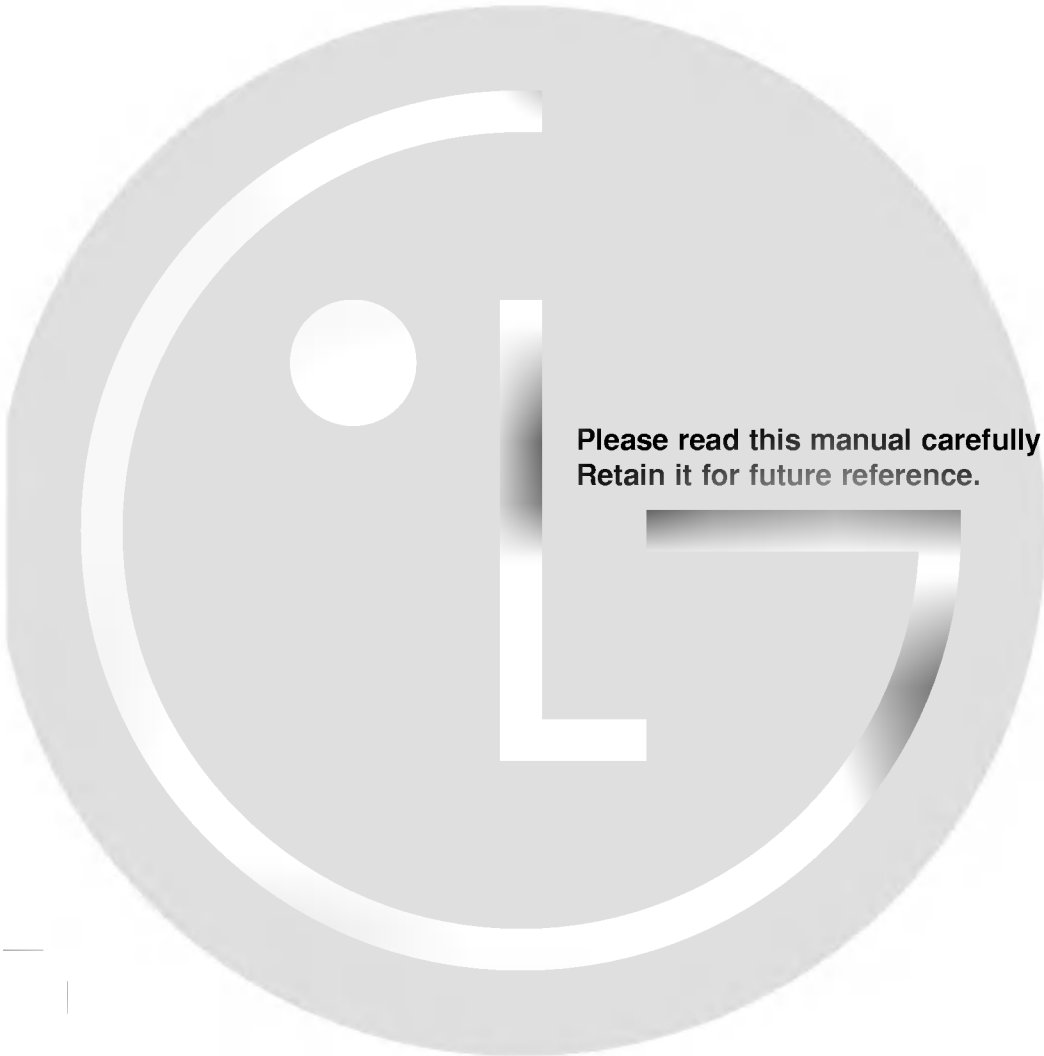

MODEL : LM-V330
(LM-V330A/S, LMS-V330V)

LM-V530
(LM-V530A/S, LMS-V530V)



Please read this manual carefully before operating your set.
Retain it for future reference.

Precautions

	CAUTION RISK OF ELECTRIC SHOCK DO NOT OPEN	
<p>CAUTION: TO REDUCE THE RISK OF ELECTRIC SHOCK DO NOT REMOVE COVER (OR BACK) NO USER SERVICEABLE PARTS INSIDE. REFER SERVICING TO QUALIFIED SERVICE PERSONNEL.</p>		

Graphical Symbols Explanation:



The lightning flash with arrowhead symbol, within an equilateral triangle is intended to alert the user to the presence of uninsulated dangerous voltage within the product's enclosure that may be of sufficient magnitude to constitute a risk of electric shock to persons.



The exclamation point within an equilateral triangle is intended to alert the user to the presence of important operating and maintenance (servicing) instructions in the literature accompanying the appliance.

WARNING

TO REDUCE THE RISK OF FIRE OF ELECTRIC SHOCK, DO NOT EXPOSE THIS APPLIANCE TO RAIN OR MOISTURE.

To avoid electrical shock, do not open the cabinet, Refer servicing to qualified personnel only.

The apparatus shall not be exposed to dripping or splashing and that no objects filled with liquids, such as vases, shall be placed on the apparatus.

CAUTION

Use of controls or adjustments or performance of procedures other than those specified herein may result in hazardous radiation exposure.

Laser component in this product is capable of emitting radiation exceeding the limit for Class 1.

CAUTION: INVISIBLE LASER RADIATION WHEN OPEN AND INTERLOCKS DEFEATED. AVOID EXPOSURE TO BEAM.

WARNING: OSYNLIG LASERSTRÅLNING NÄR DENNA DEL ÄR ÖPPNAD STRÅLEN ÄR FARLIG.

Attention: Quand l'appareil est ouvert, ne pas s'exposer aux radiations invisibles du faisceau laser.

This label is located on the interior.

<p>CLASS 1 KLASSE 1 LUOKAN 1 KLASS 1 CLASSE 1</p>	<p>LASER PRODUCT LASER PRODUKT LASER LAITE LASER APPARAT PRODUIT LASER</p>
--	---

This Compact Disc player is classified as a CLASS 1 LASER product.

The CLASS 1 LASER PRODUCT label is located on the exterior.

Table of Contents

INTRODUCTION

- Precautions 2
- Table of Contents 3
- Notes (Discs, Remote Control, Tape) 4
 - Safety Precautions 4
 - Notes on Discs 4
 - Notes on Remote Control 4
 - Notes on Tapes 4
- Identification of Controls 5-7
 - Front Panel 5
 - Remote Control 6
 - Rear Panel/Display Window 7

CONNECTION

- Antenna Connections 8
- Speaker System Connection 9
- Connecting to a TV/Monitor 9

BEFORE OPERATION

- Setting the Voltage (OPTIONAL) 10
- Setting the Clock 10
- Sleep Timer Function 10
- Timer Functions 11
- Audio Adjustment 12
 - Volume Adjustment 12
 - Sound Quality Adjustment 12
 - MUTE 12
 - SURROUND 12
 - XDSS (Extreme Dynamic Sound System) 12
- Auxiliary (External Equipment) Input 12

RADIO OPERATION

- Presetting Radio Stations 13
- Listening to the Radio 13

CASSETTE DECK OPERATION

- Tape Operation 14
 - Basic Playback 14
 - To Stop Play 14
 - Tape Counter Reset 14
 - To Play Rewind or Fast Forward 14
 - Dubbing 14
- Recording Setup 14
 - Basic Setting 14
 - Recording from Radio, CD or Auxiliary Source 14
 - CD to Tape Synchronized Recording 14

CD/VCD OPERATION

- Basic Playback 15
 - Basic Playback Setup 15
 - To Pause Play 15
 - To Stop Play 15
 - To Skip a Track or scene 15
 - To Search a track or scene 15
 - To Go to a Next Disc 15
 - To Select a Disc Directly 15
 - To Exchange Discs During Playback 15
- Advanced Playback 16-19
 - Last Scene Memory 16
 - Time Search Function 16
 - Display Function 16
 - Multiplex Function 16
 - PBC Play (Playback Control Play) 16
 - Digest Playback 17
 - Basic Setting 17
 - Intro Scan Playback 17
 - Disc Digest Playback 17
 - Disc Track Playback 17
 - Repeat Playback 18
 - Program Play Setup 18
 - MP3 Playback 19

ADVANCED OPERATION

- KARAOKE 20
 - Karaoke Function 20
 - To Adjust ECHO Volume 20
 - To Change the Key (KEY CONTROL) 20
 - Recording with Karaoke 20

REFERENCE

- System Selection (NTSC/PAL) 21
- Discs Requirements 21
- Troubleshooting 22
- Specifications 23

Notes (Discs, Remote Control, Tape)

Safety Precautions

Handling the unit

When shipping the unit

The original shipping carton and packing materials come in handy. For maximum protection, re-pack the unit as it was originally packed at the factory.

To keep the surface clean

Do not use volatile liquids, such as insecticide spray, near the unit. Do not leave rubber or plastic products in contact with the unit for a long period of time. They will leave marks on the surface.

Cleaning the unit

To clean the cabinet

Use a soft, dry cloth. If the surfaces are extremely dirty, use a soft cloth lightly moistened with a mild detergent solution. Do not use strong solvents, such as alcohol, benzine, or thinner, as these might damage the surface of the unit.

Notes on Discs

Handling discs

Do not touch the playback side of the disc.
Hold the disc by the edges so that fingerprints will not get on the surface.
Do not stick paper or tape on the disc.

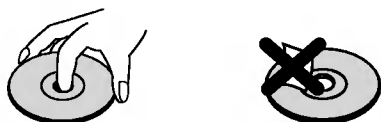

Storing discs

After playing, store the disc in its case.
Do not expose the disc to direct sunlight or sources of heat, or leave it in a parked car exposed to direct sunlight, as there may be a considerable temperature increase inside the car.

Cleaning discs

Fingerprints and dust on the disc can cause poor picture quality and sound distortion. Before playing, clean the disc with a clean cloth. Wipe the disc from the center out.



Do not use strong solvents such as alcohol, benzine, thinner, commercially available cleaners, or anti-static spray intended for analog records.

Notes on Remote Control

Remote control operating range

Point the remote control at the remote sensor and press the buttons.

- **Distance:** About 23 ft (7 m) from the front of the remote sensor.
- **Angle:** About 30° in each direction of the front of the remote sensor.

Remote control battery installation

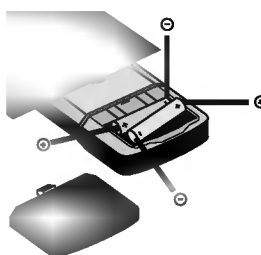

Detach the battery cover on the rear of the remote control, and insert two R03 (size AAA) batteries with + and - aligned correctly.

Caution

Do not mix old and new batteries. Never mix different types of batteries (standard, alkaline, etc.).

Notes on Tapes

Preventing overwriting a recording

Removing the safety tab(s) of the cassette (with a small screwdriver) will prevent accidental erasure.

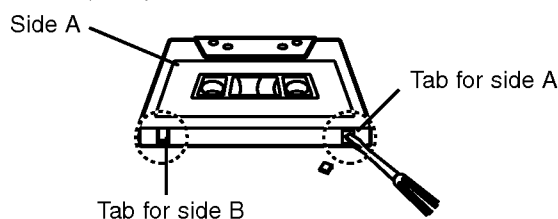

To record again, cover the hole of the tab with adhesive tape.

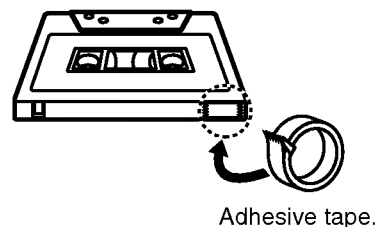

Identification of Controls (Cont'd)

Front Panel

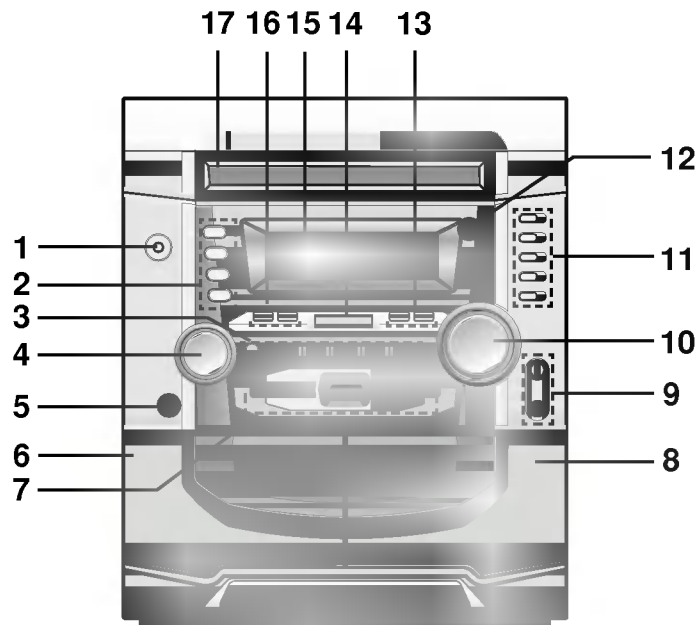

1. POWER (⏻ STANDBY/ON) button
2. • FM MODE/RIF button
• CD SYNC. button
• PROG./MEMO button
• CLOCK button
• TIMER button
3. • SET/CD PAUSE (CD ||) button
• COUNTER RESET (COUNTER) button
• PLAY MODE button : OPTIONAL
• PBC button
• HIGH DUBBING button (HI. DUBB.)
• NORMAL DUBBING button (NOR. DUBB.)
• MENU (-/+) button
• SCAN (-/+) button
• SURROUND button
• EQUALIZER (EQ) button
4. MULTI JOG SHUTTLE
5. HEADPHONE SOCKET (🎧 PHONES) - Ø6.3mm
6. ▲ PUSH EJECT position - TAPE 1 (DECK 1)
7. • REC/PAUSE (● ||) button
• TUNING (-/+) buttons
• PRESET (-/+) buttons
• SELECT button
• RETURN button
• CD SKIP (◀◀ / ▶▶) buttons
• TAPE REWIND/FAST FORWARD (◀◀ / ▶▶) buttons
• PLAY (▶) button
• REVERSE PLAY (◀) button : OPTIONAL
• STOP (■)/CLEAR button
8. ▲ PUSH EJECT position-TAPE 2 (DECK 2)
9. • MIC JACK (MIC) - Ø6.3mm : OPTIONAL
• MIC VOLUME KNOB (MIC VOL.) : OPTIONAL
10. VOLUME CONTROL KNOB
11. • CD OPEN/CLOSE (▲ OPEN/CLOSE) button
• DISC SKIP button
• DISC DIRECT PLAY buttons
(DISC 1, DISC 2, DISC 3)
12. REMOTE SENSOR
13. • TAPE button
• AUX button
14. XDSS button
15. DISPLAY WINDOW
16. • TUNER/BAND button
• MP3/CD/VCD button
17. CD DOOR

Identification of Controls (Cont'd)

You will find instructions for each of the remote control functions in the appropriate sections of this instruction manual.

Remote Control

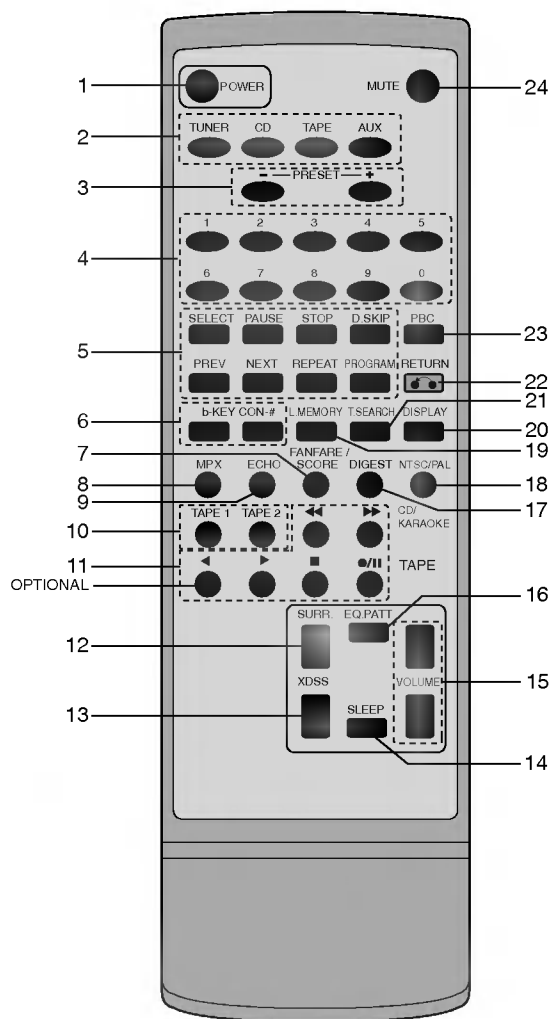

1. POWER button
2. Function select buttons (TUNER, CD, TAPE, AUX)
3. PRESET (-/+) buttons
4. Numeric buttons
5. VCD/CD CONTROL buttons
 - PLAY (▶)/SELECT
 - PAUSE (||)
 - STOP (■)
 - DISC SKIP (D.SKIP)
 - PREV/NEXT (◀◀ / ▶▶)
 - REPEAT
 - PROGRAM
6. • KEY CONTROL buttons (b - KEY CON - #)
 - SCAN/SEARCH, REWIND/FAST FORWARD (◀◀/▶▶) buttons
7. FANFARE (OPTIONAL) /SCORE button
8. MPX button
9. ECHO button
10. TAPE 1/2 SELECT buttons
11. TAPE FUNCTION buttons
 - FAST REWIND/FAST FORWARD PLAY (◀◀/▶▶)
 - BACKWARD PLAY (◀): OPTIONAL
 - FORWARD PLAY (▶)
 - STOP (■)
 - RECORD/RECORD PAUSE (●/||)
12. SURROUND (SURR.) button
13. XDSS button
14. SLEEP button
15. VOLUME +/- buttons
16. EQ PATTERN button
17. DIGEST button
18. NTSC/PAL button
19. L.(Last) MEMORY button
20. DISPLAY button
21. T.(Time) SEARCH button
22. RETURN (↺) button
23. PBC button
24. MUTE button

Identification of Controls

Rear Panel

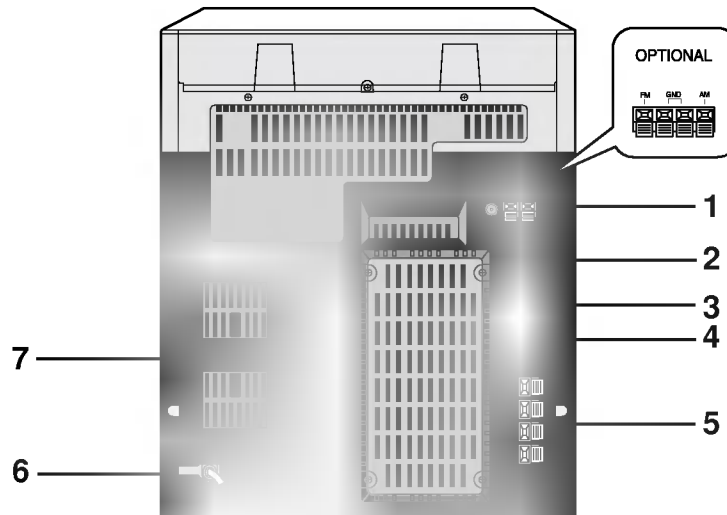

- | | |
|-------------------------|--------------------------------|
| 1. ANTENNA Terminal | 5. SPEAKER Terminal |
| 2. AUXILIARY INPUT Jack | 6. POWER Cord |
| 3. VIDEO OUT Jack | 7. VOLTAGE SELECTOR : OPTIONAL |
| 4. AUDIO (CD) OUT Jacks | |

Display Window

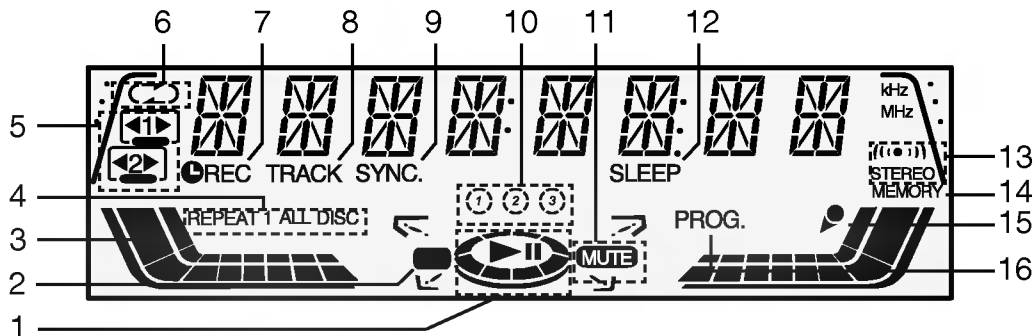

- | | |
|-----------------------------------|------------------------------------|
| 1. PLAY/PAUSE indicators | 9. CD SYNCHRO RECORDING indicator |
| 2. MP3 file indicator | 10. DISC Number indicators |
| 3. VOLUME indicator | 11. MUTE indicator |
| 4. CD REPEAT indicators | 12. SLEEP indicator |
| 5. CASSETTE DECK indicators | 13. FM STEREO RECEIVING indicators |
| 6. PLAY MODE indicator - OPTIONAL | 14. MEMORY indicator |
| 7. TIMER/RECORD indicator | 15. MIC indicator - OPTIONAL |
| 8. TRACK indicator | 16. PROGRAM indicator |

Antenna Connections

Connect the supplied AM(MW)/FM (SW : OPTIONAL) antennas for listening to the radio.

(1) 2 BAND (FM/AM) AREA

For AM(MW) reception, connect the loop antenna (aerial) to the terminal marked AM

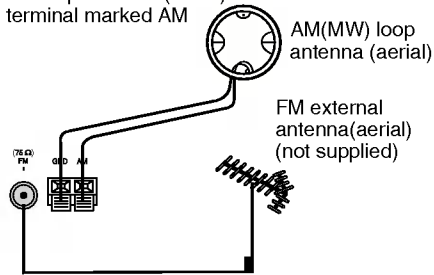

(2) 3 BAND (FM/MW/LW) AREA

For MW/LW reception, connect the loop antenna (aerial) to the terminal marked MW/LW

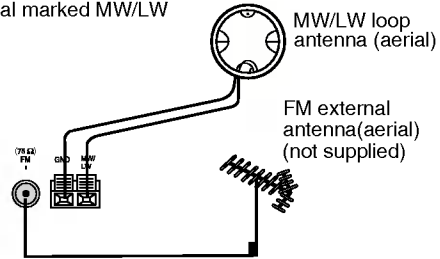

(3) 2 BAND (FM/AM) AREA

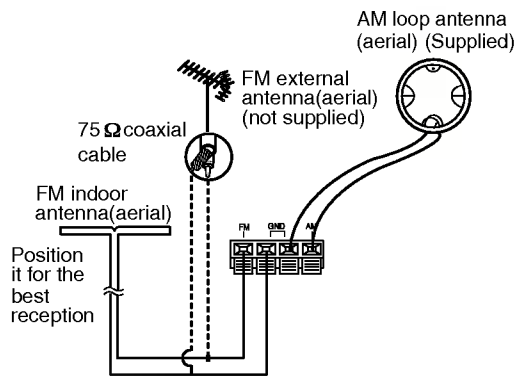

(4) 3 BAND (FM/MW/SW) AREA

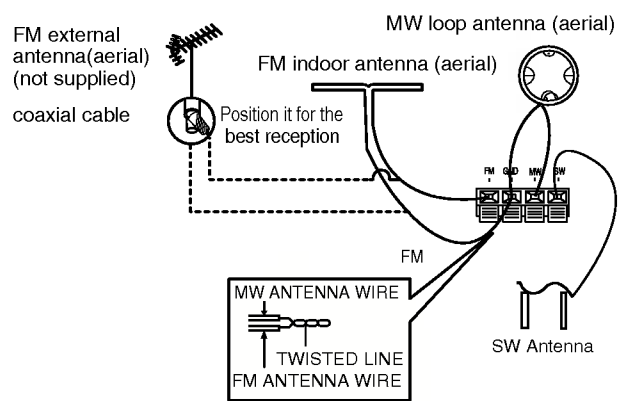

Notes

- To prevent noise pickup, keep the AM loop antenna away from the unit and other components.
- Be sure to fully extend the FM antenna wire.
- After connecting the FM antenna wire, keep it as horizontal as possible.

Speaker System Connection

Connect speaker connector to the supplied speaker cords by matching the colors of the terminals and those of the cords. To obtain the best possible surround sound, adjust the speaker parameters (distance, level, etc.).

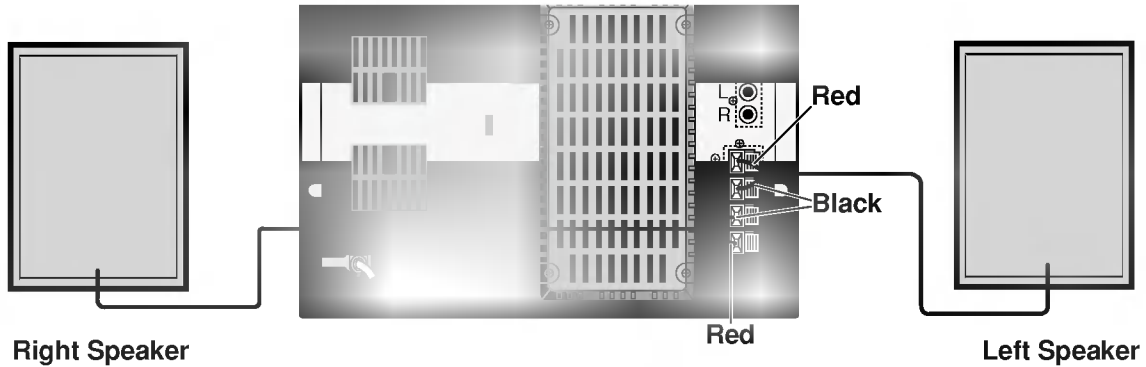

Notes

- Be sure to match the speaker cord to the appropriate terminal on the components: + to + and – to –. If the cords are reversed, the sound will be distorted and will lack bass.
- If you use front speakers with a low maximum input rating, adjust the volume carefully to avoid excessive sound output to the speakers.
- Do not disassemble the front cover of supplied speaker.

Connecting to a TV/Monitor

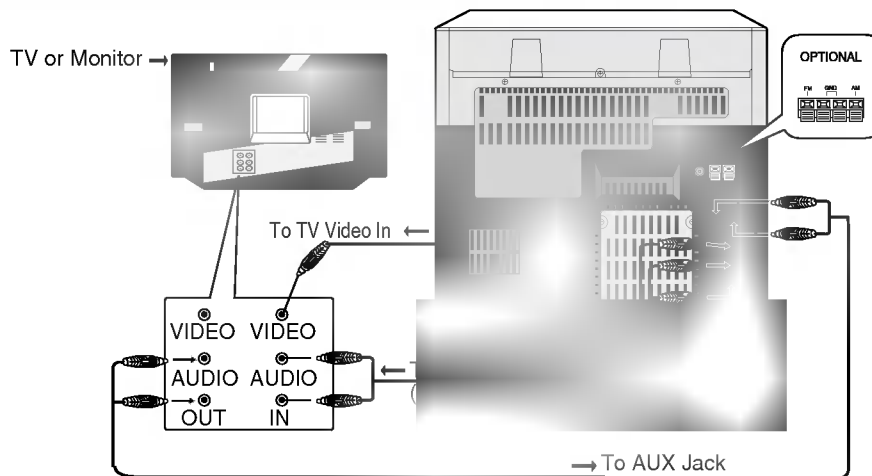

VIDEO OUT jack connection

Connect the VIDEO OUT jack on the back of the unit to a VIDEO IN jack of a TV or monitor.

AUDIO OUT jacks connection

Connect the AUDIO OUT jack on the back of the unit to a AUDIO IN jack of a TV or monitor.

AUX jacks connection

Two phones jacks marked AUX are provided on the back of the unit for connecting other units. (For example, a record player with a pre amplifier, video recorder or tape recorder.)

Notes

- Refer to the owner's manual of your TV as well.
- When you connect the unit to your TV, be sure to turn off the power and unplug both units from the wall outlet before making.

Setting the Voltage (OPTIONAL)

If your set is equipped with a voltage selector at the back side, be sure to set it to your local power supplied before connecting the AC power cord.

Setting the Clock

- 1** Press **CLOCK**.
(If the clock requires setting, press and hold **CLOCK** for more than 2 seconds.)
- The hours display begins to blink.
- 2** Select either the 24 hour cycle or the 12 hour cycle by pressing **PRESET (-/+)** or turning **MULTI JOG SHUTTLE**.



(12HR)



(24HR)
- 3** Press **SET** to confirm the selected hour cycle.
- 4** Use **PRESET (-/+)** or **MULTI JOG SHUTTLE** to set the current hour.
- 5** Press **SET**.
- 6** Use **PRESET (-/+)** or **MULTI JOG SHUTTLE** to set current minutes.
- 7** Press **SET** and the correct time is shown on the display.
- 8** Press **CLOCK** at any time to show the time on the display, for about 5 seconds.

Sleep Timer Function

When the sleep timer is set, the unit automatically turns off after the specified time has elapsed.

- 1** To specify the time delay before the power is turned off, press **SLEEP**.
In the display window you can see *SLEEP 90* for about 5 seconds. This means that the system turns off automatically after 90 minutes.
Each time the button is pressed the time interval before it turns off is reduced by 10 minutes. i.e. 80...70... etc.
Select the desired time to turn off.
- 2** To check the remaining time until the power is turned off.
While the sleep function is active press **SLEEP** briefly. The time remaining until the unit turns off is displayed for about 5 seconds.

Note

- If you press **SLEEP** while the sleep time is displayed, the SLEEP time is reset.

To cancel Sleep Timer setting

If you wish to stop the function, press the **SLEEP** button repeatedly until "SLEEP 10" appears, and then press **SLEEP** once again after "SLEEP 10" shows on the display.

Timer Functions

Using the TIMER function you can have the radio reception and recording, CD play, tape play or auxiliary source play and recording turned on and off at the time desired.

1 Press **CLOCK** to check the current time.

For your reference

If you don't set clock, timer function doesn't work.

2 Press **TIMER** to enter the timer setting mode.
TUNER-CD-TAPE flash in the display window in turn.

For your reference

If you want to correct the previous memorized TIMER setting, press and hold the **TIMER** button more than 2 seconds.

- The previous memorized timer setting for On Time and "⊙" indicators appear in the display.

3 Press **SET** when the desired function flashes.

4 1. a. When you select **TUNER** function, 'PLAY' and 'REC' indicator flash in the display window alternately for about 3 seconds.

'PLAY' indicator : TUNER play only
'REC' indicator : TUNER play and recording

b. Select the previous memorized preset number with **PRESET (-/+)** buttons or **MULTI JOG SHUTTLE** on the front panel and press **SET**.

- 'ON TIME' indicator appears for about 0.5 seconds in the display window and then disappears.

2. When you select **CD** or **TAPE** function,
- 'ON TIME' indicator appears for about 0.5 seconds in the display window and then disappears.

5 Set the turn on hour using the **PRESET (-/+)** or turning **MULTI JOG SHUTTLE**.

6 Press **SET** to confirm the turn on hour time.

7 Set the turn on minutes time using the **PRESET (-/+)** or turning **MULTI JOG SHUTTLE**.

8 Press **SET** to confirm the turn on minutes time.
'OFF TIME' indicator appears for about 0.5 seconds in the display window and then disappears .

9 Set the turn off hour time using the **PRESET (-/+)** or turning **MULTI JOG SHUTTLE**.

10 Press **SET**.

11 Set the turn off minutes using the **PRESET (-/+)** or turning **MULTI JOG SHUTTLE**.

12 Press **SET**.

13 Adjust the volume level using the **PRESET (-/+)** or turning **MULTI JOG SHUTTLE**.

14 Press **SET**.
'TIMER' appears in the display window and the timer setting has been completed.

15 Turn the system off.
The selected timer functions are automatically switched on and off at the preset times.

To cancel or check the timer

Each time the "TIMER" button is pressed you can select the timer set or cancel. You can also check the timer setting status.

To activate or check the timer, press the "TIMER" button repeatedly so that "⊙" appears in the display window.

To cancel the TIMER, press the "TIMER" button repeatedly so that "⊙" disappears from the display window.

Audio Adjustment

Volume Adjustment

- On unit, turn **VOLUME CONTROL KNOB** clockwise to increase the sound level, or counterclockwise to decrease it.
- On remote, use **VOLUME +** to increase the sound level, or use **VOLUME -** to decrease it on the remote control.

Sound Quality Adjustment

• To activate stereo sound

You can choose between 4 fixed sound impressions. Select a desired sound mode using the **EQ.PATT** on the remote control or **EQ** on the front panel.

FLAT : Linear frequency response
ROCK : More bass, more treble
POP : Less bass, less treble
CLASSIC : For orchestral music

• Headphone Jack

Connect a stereo headphone plug (ø6.3mm) into the headphone jack.

The speakers are automatically disconnected when you plug in the headphones (not supplied).

MUTE

Press **MUTE** to turn off the sound, press again to restore.

You can mute your unit in order, for example, to answer the telephone, "MUTE" indicator flashes in the display window.

SURROUND

To activate surround mode

You can choose one among 3 fixed sound impressions. Select a desired surround mode using the

SURROUND (SURR.) button.

SURROUND ON → SURROUND OFF

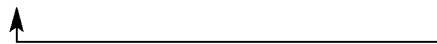

XDSS (Extreme Dynamic Sound System)

Use the **XDSS** feature to reinforce treble (Hi-Tone) and bass (UBB: Ultra Bass Booster).

The "XDSS ON" or "XDSS OFF" indicator lights up.

To cancel it press **XDSS** again.

Auxiliary (External Equipment) Input

1 Connect an auxiliary device i.e. TV or VCR, via the rear mounted AUX phone jacks.

2 Press **AUX**.

Note

- You can also record from the auxiliary input source, see Recording Section.

Presetting Radio Stations

You can preset 50 stations for FM and AM (SW : OPTIONAL). Before tuning, make sure that you have turned the volume down to the minimum level.

- 1** Press **TUNER/BAND** (or **TUNER** on the remote control) to show either **FM** or **AM** (SW : OPTIONAL) in the display window.
- 2** And then every time you press **TUNER/BAND** (or **TUNER** on the remote control), **FM** and **AM** (SW : OPTIONAL) change alternately.
- 3** Press **TUNING (-/+)** on the front panel until the frequency indication starts to change, then release.
Scanning stops when the unit tunes in a station.
- 4** Press **PROG./MEMO** on the front panel.
A preset number will flash in the display window.
- 5** Press **PRESET (-/+)** to select the preset number you want.
- 6** Press **PROG./MEMO** again.
- The station is stored.
- 7** Repeat steps 3 to 6 to store other stations.

To tune in a station with a weak signal

Use the **MULTI JOG SHUTTLE** in step 3 to tune in the station manually.

To clear all memorized stations

Press and hold **PROG./MEMO** on the front panel for about two seconds, "CLEAR" appears in the display window and then press **CLEAR** again, the stations are cleared.

For your reference

If all stations have already been entered, **FULL** message will appear in the display window for a moment and then a preset number will flash. To change the preset number, follow the steps 5-6 on the left side.

To recall preset numbers

Press and hold **PRESET (-/+)** until the desired preset number appears or press the button repeatedly.

Automatic Tuning

Use **TUNING (-/+)** for more than 0.5 seconds.

Manual Tuning

Use **TUNING (-/+)** briefly and repeatedly.
Use the **MULTI JOG SHUTTLE**.

Listening to the Radio

- 1** Use **TUNER/BAND** (or **TUNER** on the remote control) to select either **AM** or **FM** (SW : OPTIONAL) in the display window.
The last received station is tuned in.
- 2** Press **PRESET (-/+)** repeatedly to select the preset station you want.
Each time you press the button, the unit tunes in the next preset station.
- 3** Adjust the volume by rotating **VOLUME CONTROL KNOB** (or pressing **VOLUME (-/+)** on the remote control) repeatedly.

To listen to non-preset radio stations

- For manual tuning, see "Manual Tuning" as above.
- For automatic tuning, see "Automatic Tuning" as above.

To turn the radio off

Press **POWER** ( **STANDBY/ON**) to turn off the unit or to select another function mode (**MP3/CD**, **TAPE** or **AUX**).

For your reference

- **If a FM program is noisy**
Press **FM MODE/RIF** repeatedly so that "  " disappears in the display window. There will be no stereo effect, but the reception will improve. Press **FM MODE/RIF** again to restore the stereo effect.
- **To improve reception**
Reposition the supplied antennas.

Notes

- Use **FM MODE/RIF** (Radio Interference Filter) function to switch to Mono reception if stereo reception is distorted by noise.
- While recording weak AM broadcasts, if noises occurs, press **FM MODE/RIF** once.

Tape Operation

Basic Playback

- 1** Use TAPE (or TAPE-1/2 on the remote control) to select tape function.
(“NO TAPE” appears in the display window.)
- 2** Open cassette TAPE 1 (or 2) by pushing to the ▲PUSH EJECT position.
- 3** Insert one or two cassettes with the tape side to the bottom and then close the TAPE 1 (and/or 2) door.
- 4** Press ► (or ◀: OPTIONAL) on the front panel or remote control.

AUTO STOP DECK (TAPE 1/2)

After auto stop deck plays front side of cassette, the unit stops automatically.

AUTO REVERSE DECK (TAPE 2) : OPTIONAL

Select cassette playback direction (front or back) with PLAY MODE button.

Pressing	Display	Function
Once		After the cassette in deck TAPE 2 plays front or reverse (backward play) side, stops automatically.
Twice		After the cassette in deck TAPE 2 plays front and reverse side, stops automatically.
Three times		After the cassette in deck TAPE 2 plays six times repeatedly front and reverse side, stops automatically.

To Stop Play

Press STOP (■) during playback.

Tape Counter Reset

Press COUNTER during playback.

Playing time appears “TP 1 (or 2) 0000” in display window.

To Play Rewind or Fast Forward

After press ◀◀ / ▶▶ on the front panel or ◀◀/▶▶ on the remote control during playback, press PLAY (▶) at the tape position you want.

Dubbing

How to copy from one tape to another.

- 1** Press TAPE or TAPE-1/ 2.
 - Cassette TAPE 1- Insert the playback tape to dub.
 - Cassette TAPE 2- Insert a blank tape to copy on.

- 2** Press NOR. /HI. DUBB. as indicated below.

Press	Display	Function
NOR. DUBB.	<i>NOR DUBB</i>	Normal speed copying.
HI. DUBB.	<i>HI DUBB</i>	Double speed copying.

To stop recording, press STOP (■).

Recording Setup

Basic Setting

- 1** Press MP3/CD or TUNER/BAND to select source.
- 2** Open the cassette deck TAPE 2 and insert a blank cassette into the cassette compartment.
Set the recording direction :OPTIONAL
Press PLAY MODE repeatedly to set the recording direction.

Recording from Radio, CD or Auxiliary source

- 1** Press ●/|| on the front panel.
“REC” flashes and holds the cassette in pause mode.
- 2** Press ► (or ◀: OPTIONAL) on the front panel or remote control.
The recording is begun.

To pause the recording, press ●/|| .
(“REC” flashes in display widow.)
To pause the recording, press STOP(■).

CD to Tape Synchronized Recording

The CD synchro recording function dubs a complete CD and programmed titles automatically into a cassette.

- 1** Press CD SYNC. in stop mode.
“●REC” flashes and “CD SYNC” displays in the display window.
- 2** The synchronized recording is started automatically after about 7 seconds.

Notes

- If you wish to record from the desired track, select the desired track with ◀◀ / ▶▶ or MULTI JOG SHUTTLE before commencing CD synchro recording.
- A function change is not possible during recording.

Basic Playback

Preparation

In case of using a TV

Turn on the TV and select the video input so that you can view the pictures from this unit.

In case of using an amplifier

Turn on the amplifier and select the CD player position so that you can listen to the sound from this unit.

Basic Playback Setup

1 Press **POWER** ( **STANDBY/ON**) to turn on the unit.

2 Press the **MP3/CD** (or **Video CD**) button to select **CD** function.

If no disc is in the disc drawer, the "NO DISC" indicator appears.

3 Press **CD OPEN/CLOSE** ( **OPEN/CLOSE**) and place the disc into the disc tray.

The disc on the left (DISC 1) is played first.



With the label side up



Note

○ To load an 8cm (3 inch) disc, put it onto the inner circle of the tray.

4 Press **CD OPEN/CLOSE** ( **OPEN/CLOSE**) to close the disc compartment.

5 Press **▶** (or **▶/||** on the remote control).

To Pause Play

Press **CD PAUSE** () or **PLAY/ PAUSE** ( / **||**) during playback.

Press the button again to resume play.

To Stop Play

Press **STOP** () during playback.

To Skip a Track or scene

- Turn **MULTI JOG SHUTTLE** to select the track.
- Press **NEXT** button to go to the next scene or track.
- Press **PREV.** button to go to the back preceding scene or track.

To Search a track or scene

Press **◀◀/ ▶▶** repeatedly during playback.

(When a desired scene is displayed, press **PLAY** ().)

(TV screen)

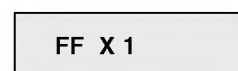

- The speed of advance (reverse) is relatively slow at first. When the button is pressed again, the speed becomes faster. (Each time the button is pressed, the speed increases up to 4 steps.)
- The speed will be retained even after the button is released.

To Go to a Next Disc

Press **DISC SKIP** during playback or in stop mode.

To Select a Disc Directly

Press **DISC 1**, **DISC 2** or **DISC 3** during playback or in Stop mode.

When you press DISC 1-3 before playing a disc, the unit will automatically start playing the selected disc.

To Exchange Discs During Playback

You can open the disc tray while playing a disc to check what discs are to be played next and exchange discs, without interrupting playback of the current disc.

1 Press **CD OPEN/CLOSE** ( **OPEN/CLOSE**).

The disc tray is opened. Two disc compartments appear. Even if the unit is playing a disc, it doesn't stop playing.

2 Replace discs in the compartments with other ones.

The unit plays the disc in the left compartment after the current disc, and then the one in the right compartment.

3 Press **CD OPEN/CLOSE** ( **OPEN/CLOSE**).

The CD door closes.

Notes

- Do not place more than one compact disc on one disc tray at the same time.
- Do not push on the disc tray to close CD door, you may damage the unit.

Advanced Playback (Continued)

Last Scene Memory

The unit memorizes the point you stopped a VIDEO CD and you can resume playback from that point. It is not available during playing an audio CD.

- 1** Press **STOP** (■) during playback.
- 2** Press **L. MEMORY** on the remote control.
 - The unit starts playback from the point you stopped the VIDEO CD in step 1.
 - "RESUME" appears on the TV screen.

Time Search Function

This function lets you use elapsed time as a guide to find a certain point on a VIDEO CD. Time Search function is especially useful when playing discs that have only a few track divisions.

- 1** Press **T.SEARCH** during playing or stopping. (TV screen)

TIME SEARCH _:_:__

- 2** Press the **NUMERIC** buttons to enter the time of the point that you want to locate. Playback is started automatically from the entered time.

TIME SEARCH 22:15

For your reference

- This function can not be used during Digest Play , AUDIO CD and VIDEO CD with PBC function (Version 2.0 discs).

Display Function

- Press **DISPLAY** during playing.
 - You can view the elapsed time per a track.
- Press **DISPLAY** again during playing.
 - You can view the remained time per a track.
- Press **DISPLAY** once more during playing.
 - You can view the total remained time on the disc.

Multiplex Function

You can select the sound from the right or left channel and listen to the sound of the selected channel through both the right and left speakers. In this case, the sound loses the stereo effect.

Press MPX during playing a disc.

Each time you press the button, the indication and the sound from the speakers change as follows.

Pressing	Screen	Function
Once	MONO L	You can hear the sound of the left channel.
Twice	MONO R	You can hear the sound of the right channel.
Three times	STEREO	You can hear the standard stereo sound.

Notes

- This screen doesn't appear on the display window.
- This function doesn't work for TUNER, TAPE and AUX functions.

PBC Play (Playback Control Play)

- When playing VIDEO CD with PBC functions (Version 2.0 discs), you can enjoy playing simple interactive software, software with search functions, etc.
- PBC play allows you to play VIDEO CD interactively, following the menu screen on the TV screen.
- Also refer to the instructions supplied with the disc, as the operating procedure may differ according to the VIDEO CD.

- 1** Insert VIDEO CD with PBC function, press **PLAY** (▶). "PBC" appears in the display window.

- 2** Select the menu number you want by pressing **NUMERIC** buttons on the remote control. The selected item is now executed. (Or Select the menu number you want by pressing the **MENU** (-)/(+) on the front panel, and then press the **PLAY** (▶) or **SELECT** button.)

To Stop play

Press **STOP** (■) during playback.

To go the next of a menu

Press **NEXT**.

To go back to a previous menu

Press **PREV.**.

To go back to the top of a menu

Press **RETURN** (↶).

Advanced Playback (Continued)

Digest Playback

Notes

- This function is not used in MP3 file CD.
- If you start Digest play before you start playing a VIDEO CD with PBC functions, the unit automatically starts playing without PBC functions.

Basic Setting

You can locate the disc or scene you want by observing several still pictures at one time on the TV screen.

Press DIGEST during stopping.

The following menu appears on the TV screen.



Intro Scan Playback

Press NUMERIC button 1.

- This function only plays 10 seconds the beginnings of each track or scene on the disc.

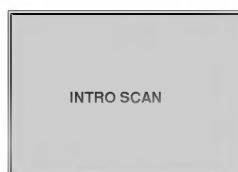

- In case of audio CD, you can only hear a sound.
- In case of VIDEO CD, you will also see a scene.

Disc Digest Playback

You can locate the track you want by observing the first picture of 9 tracks on the disc at one time on the TV screen.

1 Press NUMERIC button 2.

- During playing a VIDEO CD, the TV screen shows still picture of the first scenes of tracks 1 to 9.

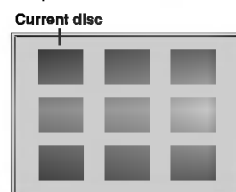

To view still pictures of the tracks of the tracks numbered over 9

Press NEXT (▶▶).

- The TV screen shows still pictures of tracks 10 to 18.
- To go back to the previous screen, press PREV..

2 Press NUMERIC buttons to select the track you want.

The unit starts playing from the selected track.

To cancel Disc digest playback

Press STOP (■).

Disc Track Playback

You can locate the point you want by observing first picture of 9EA of each section at one time on the TV screen. This might be useful when you play a disc which is divided into a few tracks, such as a movie.

1 Press NUMERIC button 3.

- During playing a VIDEO CD, the unit divides the track into 9 sections and TV screen shows still pictures of each section in order.

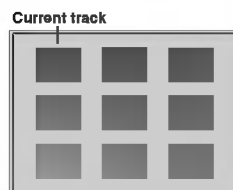

For your reference

To view sections of another track, press NEXT such as Disc digest play.

2 Press NUMERIC buttons to select the point you want.

The unit starts playing from the selected point.

To cancel Disc track play

Press STOP (■).

Advanced Playback (Continued)

Repeat Playback

NOTE: The repeat play does not work in PBC ON status of the VIDEO CD with PBC function (Version 2.0).

To play one track repeatedly

Press **REPEAT** once during playback.
- "REPEAT 1" appears in the display window.

To play one disc repeatedly

Press **REPEAT** again during playback.
- "REPEAT 1 DISC" appears in the display window.

To play all tracks on all disc repeatedly

Press **REPEAT** once more during playback.
- "REPEAT ALL DISC" appears in the display window.

To cancel repeat play

- Press **REPEAT** several times until "repeat indicator" disappears.

Program repeat play

- Press **REPEAT** once during program play.
 - "REPEAT 1" appears in the display window.
(One track repeat)
- Press **REPEAT** again during program play.
 - "REPEAT ALL DISC" appears in the display window.
(All program repeat)

Program Play Setup

You can arrange the order of the tracks on the discs and create your own program. The program can contain up to 20 tracks.

Notes

- The program playback does not work in PBC ON status of the VIDEO CD with PBC function (Version 2.0).
- This function is not available to MP3 discs.

1 Press **PROG./MEMO** (or **PROGRAM** on the remote control) in the Stop mode.

Program Order Track Number

 Disc Number

2 Press **D.SKIP** or **DISC DIRECT PLAY (DISC1/2/3)** to select the disc.

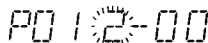

3 Use **PREV./NEXT** or turn **MULTI JOG SHUTTLE** to select the track.

In case of using **NUMERIC (0~9)** button, press "0" and "3".

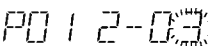

4 Press **PROG./MEMO** (or **PROGRAM** on the remote control).

5 Repeat steps 1~5 to select additional discs and tracks.

6 Press **PLAY (▶)**.

To check program contents

Press **PROG./MEMO** (or **PROGRAM** on the remote control) in Stop mode.

- A disc, track and program number will be displayed.

To clear program contents

Press **PROG./MEMO** (or **PROGRAM** on the remote control) in stop mode. Then press **CLEAR** on the front panel or **STOP (■)** on the remote control.

To add program contents

1. Press **PROG./MEMO** (or **PROGRAM** on the remote control) repeatedly in the program Stop mode until "Disc Number" blinks.
2. Repeat steps 2~5 as shown to the above.

To modify program contents

1. Use **PROG./MEMO** (or **PROGRAM** on the remote control) to display program number you want to modify.
2. Repeat steps 2~5 as shown to the above.

Advanced Playback

MP3 Playback

- 1** Load an MP3 disc.
The ROOT directory menu is displayed on the TV screen.

```

FOLDER : ROOT
        PAGE 01/01
→TRACK_1  TRACK_2
  TRACK_3  TRACK_4
  TRACK_5  TRACK_6
  TRACK_7  TRACK_8
  TRACK_9
  
```

- 2** Press **PREV./NEXT** to select the directory where MP3 files that you want to play are located and then press **SELECT**.

```

MP3 FILE : TRACK_1
          PAGE 01/02
→MUSIC_1  MUSIC_2
  MUSIC_3  MUSIC_4
  MUSIC_5  MUSIC_6
  MUSIC_4  MUSIC_4
  MUSIC_5  MUSIC_5
  
```

- 3** Press **PREV./NEXT** to select the desired MP3 file of the selected directory on the disc.

```

MP3 FILE : TRACK_1
          PAGE 01/02
MUSIC_1  MUSIC_2
MUSIC_3  →MUSIC_4
MUSIC_5  MUSIC_6
MUSIC_4  MUSIC_4
MUSIC_5  MUSIC_5
  
```

- 4** Press **PLAY (▶)** to start playback of a file.

For your reference

- Press **PREV./NEXT** to play the next file or previous file during playback.
- Press **RETURN (↵)** to move to the ROOT directory during playback.

```

FOLDER : ROOT
        PAGE 01/01
→TRACK_1  TRACK_2
  TRACK_3  TRACK_4
  TRACK_5  TRACK_6
  TRACK_7  TRACK_8
  TRACK_9
  
```

Notes

- The directory and file name is only displayed in English.
- If you select another file by pressing **PREV./NEXT** during playback, the file is played after 5 seconds automatically.

To Play an MP3 file repeatedly

- If you press **REPEAT** once during playback, the current MP3 file will play repeatedly. "REPEAT 1" appears in the display window.
- If you press **REPEAT** twice during playback, the all MP3 files on the disc will play repeatedly. "REPEAT 1 DISC" appears in the display window.
- If you press **REPEAT** three times, the repeat play will be cancelled.

For your reference



- Press **PREV./NEXT** to play the next file or previous file during playback.
- Press **PAUSE (II)** to enter the pause mode, press **PLAY** or **PAUSE (II)** again to return to normal playback.
- Press **STOP (■)** to stop the playback.

KARAOKE

Karaoke Function

You can play KARAOKE(singing along) with CD by connecting a microphone to the unit.

You can enjoy KARAOKE with a stereo-recorded disc, even if it is a non-karaoke disc, by reducing the singer's voice.

- 1** Press **POWER** ( **STANDBY/ON**) to turn on the player.
- 2** Select the CD function.
- 3** Press **CD OPEN/CLOSE**( **OPEN/CLOSE**) to open the disc compartment, load a disc with the label side up.
In case of a VIDEO CD with PBC functions, "PBC" appears in the display window. Press **PBC** to cancel it.
- 4** **Connect your microphone to the MIC jack.**
Turn the MIC VOLUME knob to adjust the microphone volume.
- 5** Press **FANFARE (OPTIONAL)/SCORE** to enter the karaoke mode.
In case of Video CD, "KARAOKE" appears in the screen.
- 6** Select the desired track number on the disc by pressing **PREV./NEXT** (or turning **MULTI JOG SHUTTLE**).
If you press the **NUMERIC** buttons, the playback is started automatically.
- 7** Press **PLAY**().
Sing along with the accompaniment.

For your reference

To play the next, press **PREV./NEXT** or turn **MULTI JOG SHUTTLE** again.

Note

- **Come out the Fanfare (OPTIONAL) & Score**
If the track playback is finished, the score will appear on the screen, and if you take the score 70 points and over the fanfare sound comes out. And the unit will automatically pause after playing back of each track.

To Adjust ECHO Volume

You can give an echo effect to the sound from the microphone.

- **Press ECHO repeatedly to adjust the strength of echo.**
ECHO-1, ECHO-2 or ECHO-3 is displayed in the display window.
- **To cancel it, set the echo indication disappear in the display window.**

To Change the Key (KEY CONTROL)

You can change the key to suit your vocal range.

Press **KEY CONTROL (b - KEY CON - #)** buttons repeatedly to find the key that suits your vocal range.

You can adjust the key to 15 steps (7 higher steps , 7 lower steps and the original key).
- The setting appears on the screen.

Recording with Karaoke

You can record during playing KARAOKE.
Refer to the "RECORDING" explanation section.

Notes

- **If howling occurs**
 - Move the microphone(s) away from the TV or the speakers.
 - Lower the volume of the TV or the mic volume.
 - Cancel ECHO function.
- **If the sound is distorted when the unit is connected a TV**
 - Cancel ECHO function.
- If sound through the microphone is extremely loud it may be distorted. In this case turn the MIC volume toward minimum and set to "ECHO OFF" by pressing **ECHO**.

System Selection (NTSC/PAL)

You can enjoy NTSC or PAL discs by using the **NTSC/PAL** button to choose the appropriate system.

- If you try to play back PAL disc with NTSC-TV. The unit will not play back the disc.
- When the system of your unit does not coincide with the system of your TV, normal color picture may not be displayed.
- When you play back NTSC disc with PAL-TV, some discs may produce black bands at the top and bottom of the screen.

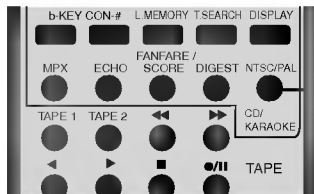

NTSC/PAL

Position of System Select	Connected TV	Available disc
PAL	PAL	PAL VCD disc
NTSC	NTSC	NTSC VCD disc
NTSC or PAL	MULTI system TV	NTSC/PAL disc

Disc Requirements

This unit can play back the following discs.

This equipment has been designed to play discs bearing the identification logo shown as below.

CD: compact disc recorded only with digital audio signals.

VIDEO CD : compact disc recorded with compressed digital audio and video signals.

	Disc mark	Contents	Disc Size	Maximum Playback Time
Video CD		Audio + Video	12 cm	74 minutes
			8 cm	20 minutes
Audio CD		Audio	12 cm	74 minutes
			8 cm	20 minutes

In addition, this unit can play a CD-R or CD-RW that contains audio titles or MP3 files.

Notes on VIDEO CD		CAUTION
This player conforms to Version 1.1 and Version 2.0 of VIDEO CD standards. You can enjoy two kinds of playback according to the discs type.		<ul style="list-style-type: none"> • Small impact while video disc is playing can cause abnormality on pictures. • Because video disc reproduces data compressed in 1/100 of regular disc, even a minor scratch on its surface can cause enormous influence on video and audio and even make the disc useless. Therefore, much more care is required. • A mosaic with faint checker pattern can appear on the pictures with many movements and detailed motion, however, this is not a defect.
Disc Type	You can	
VIDEO CD without PBC functions (Version. 1.1 disc)	Enjoy video playback (moving pictures) as well as music.	
VIDEO CD with PBC functions (Version 2.0 discs)	Play interactive software using menu screens displayed on the TV screen, in addition to the video playback function of Version 1.1 discs.	

Notes

- Discs should be kept clean at all times. -Stains, scratches and dust on disc's surface cause bad quality video and audio.
- Never touch disc's surface.
- Depending on the conditions of the recording equipment or the CD-R/RW disc itself, some CD-R/RW discs cannot be played on the unit.

Troubleshooting

Check the following guide for the possible cause of a problem before contacting service.

Symptom	Cause	Possible Solution
No power.	<ul style="list-style-type: none"> The power cord is disconnected. 	<ul style="list-style-type: none"> Plug the power cord into a wall power outlet securely.
No picture.	<ul style="list-style-type: none"> The TV is not set to receive VCD signal output. The video cable is not connected securely. The connected TV power is turned off. 	<ul style="list-style-type: none"> Select the appropriate video input mode on the TV so the picture from the unit appears on the TV screen. Connect the video cables into the jacks securely. Turn on the TV.
There is no sound or only a very low-level sound is heard.	<ul style="list-style-type: none"> The audio cables are not connected securely. 	<ul style="list-style-type: none"> Insert the audio cable into the jacks securely.
	<ul style="list-style-type: none"> The power of the equipment connected with the audio cable is turned off. 	<ul style="list-style-type: none"> Turn on the external equipment connected with the audio cable.
	<ul style="list-style-type: none"> The audio connecting cord is damaged. 	<ul style="list-style-type: none"> Replace it with new one.
The playback picture is poor.	<ul style="list-style-type: none"> The disc is dirty. 	<ul style="list-style-type: none"> Clean the disc.
The unit does not start playback.	<ul style="list-style-type: none"> The disc is placed upside down. 	<ul style="list-style-type: none"> Place the disc with the playback side down.
	<ul style="list-style-type: none"> The disc is not placed within the guide. 	<ul style="list-style-type: none"> Place the disc on the disc tray correctly inside the guide.
	<ul style="list-style-type: none"> The disc is dirty. 	<ul style="list-style-type: none"> Clean the disc.
Severe hum or noise is heard.	<ul style="list-style-type: none"> The plugs and jacks are dirty. 	<ul style="list-style-type: none"> Wipe them with a cloth slightly moistened with alcohol.
	<ul style="list-style-type: none"> The disc is dirty. 	<ul style="list-style-type: none"> Clean the disc.
	<ul style="list-style-type: none"> The speakers and components are connected poorly. 	<ul style="list-style-type: none"> Connect the speakers and components securely.
	<ul style="list-style-type: none"> The unit is located with TV nearby. 	<ul style="list-style-type: none"> Move your TV away from the audio components.
Recording cannot be done.	<ul style="list-style-type: none"> The components are connected incorrectly. 	<ul style="list-style-type: none"> Connect the components correctly.
	<ul style="list-style-type: none"> The source is selected incorrectly. 	<ul style="list-style-type: none"> Select the source with the FUNCTION SELECT button (CD, TAPE, AUX or TUNER).
Radio stations cannot be tuned in.	<ul style="list-style-type: none"> The antennas are connected poorly. 	<ul style="list-style-type: none"> Connect the antenna securely.
		<ul style="list-style-type: none"> Adjust the antennas and connect an external antenna if necessary.
The remote control does not work properly.	<ul style="list-style-type: none"> The signal strength of the stations is too weak (when tuning in with automatic tuning). 	<ul style="list-style-type: none"> Tune in the station manually.
	<ul style="list-style-type: none"> The remote control is not pointed at the remote sensor on the unit. 	<ul style="list-style-type: none"> Point the remote control at the remote sensor on the unit.
	<ul style="list-style-type: none"> The remote control is too far from the unit. 	<ul style="list-style-type: none"> Operate the remote control within about 23 ft (7 m).
	<ul style="list-style-type: none"> There is an obstacle in the path of the remote control and the unit. 	<ul style="list-style-type: none"> Remove the obstacle.
	<ul style="list-style-type: none"> The batteries in the remote control are exhausted. 	<ul style="list-style-type: none"> Replace the batteries with new ones

Specifications

SECTION		MODEL	LM-V330A/S	LM-V530A/S
[General]	Power Supply	Refer to the back panel of the unit.		
	Power Consumption		80W	110W
	Weight (Approx.)		6.8kg	8.3kg
	External Dimensions (W x H x D)	273 x 330 x 360 mm		
[VCD/CD]	Frequency response	40 - 18000 Hz		
	Signal-to-Noise Ratio	70 dB (1 kHz)		
	Dynamic range	70 dB (1 kHz)		
	Video output	1.0 V, 75 Ω, RCA jack		
[Tuner]	FM	Tuning Range	87.5 - 108.0 MHz or 65 - 74 MHz, 87.5 - 108.0 MHz	
		Intermediate Frequency	10.7 MHz	
		Signal-to-Noise Ratio	60/55 dB (MONO/STEREO)	
		Frequency Response	60 - 10000 Hz	
	AM	Tuning Range	522 - 1611 kHz or 530 - 1610 kHz	
		Intermediate Frequency	450 kHz	
		Signal-to-Noise Ratio	35 dB	
		Frequency Response	100 - 2000 Hz	
	SW (option)	Tuning Range	5800 - 18000 kHz	
		Intermediate Frequency	450 kHz	
[Amp]	Output Power		30W + 30W	50W + 50W
	T.H.D	0.15%		
	Frequency Response	42 - 25,000 Hz		
	Signal-to-Noise Ratio	80 dB		
[TAPE]	Tape Speed	4.75cm/sec		
	Wow Flutter	0.25% (MTT-111, JIS-WTD)		
	F.F/REW Time	120sec (C-60)		
	Frequency Response	125 - 8000Hz		
	Signal to Noise Ratio	43dB (P/B)/ 43dB (R/P)		
	Channel Separation	50dB (P/B)/45dB (R/P)		
	Erase Ratio	55dB (MTT-5511)		
[Speakers]	MODEL		LMS-V330V	LMS-V530V
	Type		2 Way 2 Speaker	2 Way 2 Speaker
	Impedance		6 Ω	6 Ω
	Frequency Response		80 - 20000 Hz	60 - 20000 Hz
	Sound Pressure Level		87 dB/W (1m)	85 dB/W (1m)
	Rated Input Power		30 W	50 W
	Max. Input Power		60 W	100 W
	Net Dimensions (W x H x D)		192 x 326 x 215 mm	192X326X215mm
	Net Weight (Approx.)		2.67 kg	3.6kg

* Designs and specifications are subject to change without notice.



P/NO :3834RH0021E