



# Colour Television

## **OWNER'S MANUAL**

Please read this manual carefully before operating your set.  
Retain it for future reference.  
Record model number and serial number of the set.  
See the label attached on the back cover and quote this information to your dealer when you require service.

Model number :  
Serial number :

---

# Contents

---

<b>Installation</b>	<b>3</b>
<b>Location and function of controls</b>	<b>4</b>
Remote control handset	
Battery installation	
Front panel	
<b>Basic operation</b>	<b>7</b>
On and off / Programme selection	
Volume adjustment / Quick view	
Mute function / Auto Demonstration	
On screen language selection (option)	
<b>On screen menus</b>	<b>8</b>
Menu selection	
<b>Setting up TV stations</b>	<b>9</b>
Auto programme tuning	
Manual programme tuning	
Fine tuning / Programme edit	
Favourite programme	
Calling the programme table	
<b>Picture adjustment</b>	<b>14</b>
PSM (Picture Status Memory)	
DRPC (Digital Reality Picture Clarity)	
VM (Velocity Modulation)	
Picture adjustment	
Convergence / Picture format	
Turbo picture selection (option)	
<b>Sound adjustment</b>	<b>18</b>
SSM (Sound Status Memory) / Sound adjustment	
Turbo sound selection (option)	
Sound output selection / Stereo/Dual reception	
NICAM reception (option)	
<b>Time setting</b>	<b>21</b>
Clock / On/Off time	
Auto sleep	
<b>Other functions</b>	<b>22</b>
TV and AV modes / VGA mode (option)	
Auto AV switching (option)	
Child lock / Sleep timer	
<b>PIP operation (option)</b>	<b>24</b>
On and off / Input mode selection for sub picture	
Swapping between main and sub pictures	
Programme selection for sub picture	
Sub picture size / Sub picture freeze	
Sub picture position change / Programme scan	
<b>Teletext (option)</b>	<b>25</b>
Switch on/off	
SIMPLE text / TOP text (option)	
FASTEXT / Special teletext functions	
<b>Connection of external equipment</b>	<b>28</b>
Aerial socket / Euro scart sockets (option)	
Audio/Video in/out sockets (option)	
Variable Audio out sockets (AUDIO OUT)	
S-Video/Audio in sockets (S-AV) (option)	
Component in sockets / Monitor out sockets	
PC Input/Audio in sockets (option)	
<b>Troubleshooting check list</b>	<b>30</b>

---

---

# Installation

---

## Power

This set operates on an AC mains supply, the voltage is as indicated on the label on the back cover. Never apply DC power to the set. In the event of thunderstorms or powercuts, please pull out the aerial and mains plugs.

## Warning

To prevent fire or shock hazard, do not expose the set to rain or moisture.

## Service

Never remove the back cover of the set as this can expose you to very high voltage and other hazards. If the set does not operate properly, unplug it and call your dealer.

## Aerial

Connect the aerial cable to the socket marked  $75\ \Omega$  on the back cover. For the best reception an outdoor aerial should be used.

## Location

Position your set so that no bright light or sunlight falls directly onto the screen. Care should be taken not to expose the set to any unnecessary vibration, moisture, dust or heat. Also ensure that the set is placed in a position to allow a free flow of air. Do not cover the ventilation openings on the back cover.

Do not place the set on a sloping or unstable area as the casters on the bottom of the set may cause it to move and to be damaged.

When displaying still pictures such as videogames, 16:9 or 4:3 picture format, PIP display, and station label for a long time, the image may be persisted on the screen.

**Manufactured under license from Dolby Laboratories. "Dolby", "Pro Logic" and the double-D symbol are trademarks of Dolby Laboratories.** (In RT-40NZ60 series only)

# Location and function of controls

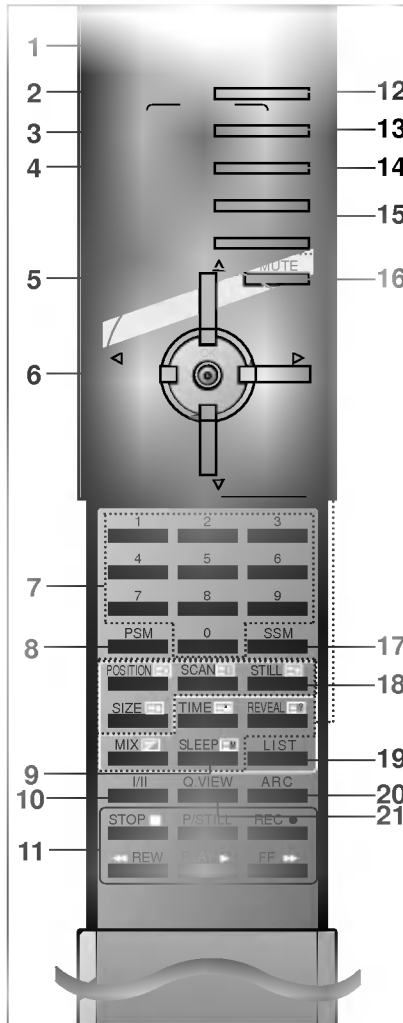

(With TELETEXT / PIP)

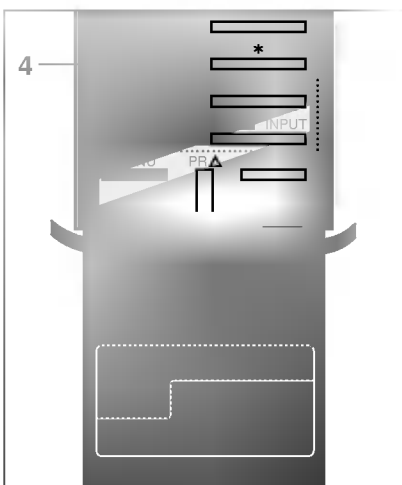

(Without TELETEXT/With PIP)

All the functions can be controlled with the remote control handset. Some functions can also be adjusted with the buttons on the front panel of the set.

## Remote control handset

Before you use the remote control handset, please install the batteries. See the next page.

1. **POWER**  
switches the set on from standby or off to standby.
2. **TV/AV**  
selects TV or AV mode.  
switches the set on from standby.
3. **TURBO SOUND BUTTON**  
selects Turbo sound.
4. **PIP BUTTONS (option)**  
**PIP**  
switches the sub picture on or off.  
**PR +/-**  
selects a programme for the sub picture.  
**SWAP**  
alternates between main and sub picture.  
**INPUT**  
selects the input mode for the sub picture.  
**SIZE**  
adjusts the sub picture size.  
**STILL**  
freezes motion of the sub picture.  
**POSITION**  
relocates the sub picture in clockwise direction.  
**SCAN**  
switches on or off the programme scan mode 12 sub pictures.
5. **MENU**  
selects a menu.
6. **D / E (Programme Up/Down)**  
selects a programme or a menu item.  
switches the set on from standby.  
**F / G (Volume Up/Down)**  
adjusts the volume.  
adjusts menu settings.  
**OK**  
accepts your selection or displays the current mode.
7. **NUMBER BUTTONS**  
switches the set on from standby or directly select a number.
8. **PSM (Picture Status Memory)**  
recalls your preferred picture setting.
9. **SLEEP**  
sets the sleep timer.
10. **I/II**  
selects the language during dual language broadcast.  
selects the sound output (option).
11. **VCR BUTTONS**  
control a LG video cassette recorder.

## Location and function of controls

- 12. MULTIMEDIA**  
selects **Component 1** or **Component 2** modes.
- 13. TURBO PICTURE BUTTON**  
selects Turbo picture.
- 14. TELETEXT BUTTONS (option)**  
These buttons are used for teletext.  
For further details, see the 'Teletext' section.
- 15. SWAP**  
returns to the previously viewed programme.  
selects a favourite programme.
- 16. MUTE**  
switches the sound on or off.
- 17. SSM (Sound Status Memory)**  
recalls your preferred sound setting.
- 18. STILL**  
freezes motion of the picture.
- 19. LIST**  
displays the programme table.
- 20. ARC**  
select your desired picture format.
- 21. Q.VIEW**  
returns to the previously viewed programme.  
selects a favourite programme.

**\* : No function**

**COLOURED BUTTONS :** These buttons are used for teletext (only TELETEXT models) or programme edit.

**Note :** In teletext mode, the **PR +/-**, **SWAP** and **INPUT** buttons are used for teletext function.

### Battery installation

The remote control handset is powered by two AAA type batteries. To load the batteries, turn the remote control handset over and open the battery compartment. Install two batteries as indicated by the polarity symbols (⊕ and ⊖) marked inside the compartment.

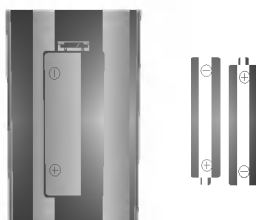

**Note :** To avoid damage from possible battery leakage, remove the batteries if you do not plan to use the remote control handset for an extended period of time.

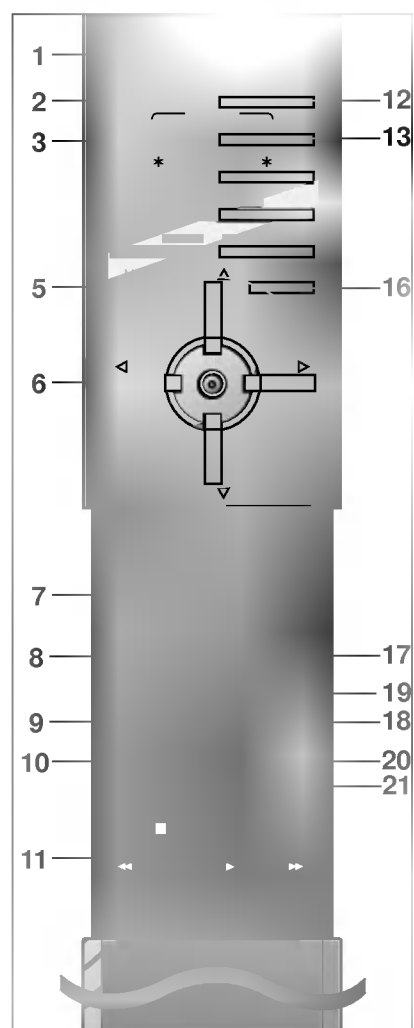

(Without PIP/TELETEXT)

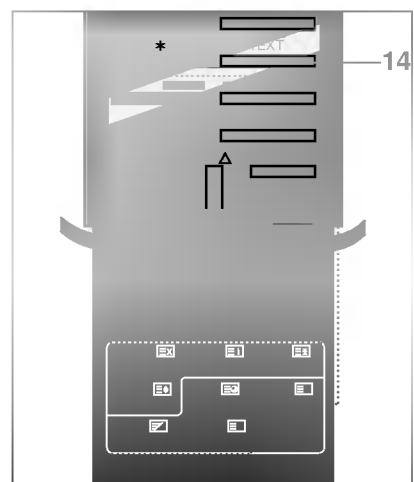

(With TELETEXT/Without PIP)

# Location and function of controls

## Front panel

### • RT-44/49/54NA13/14 series

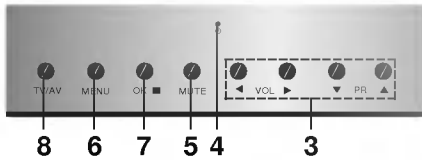

### • RT-44/49/54NA23/24 series

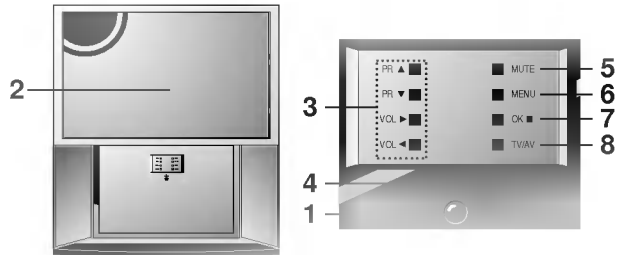

### • RT-62NA33 series

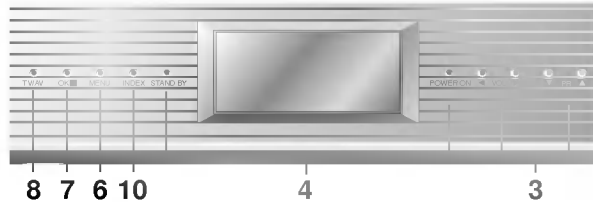
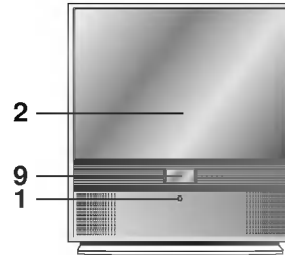

### • RT-44/49/54NA43/44 series

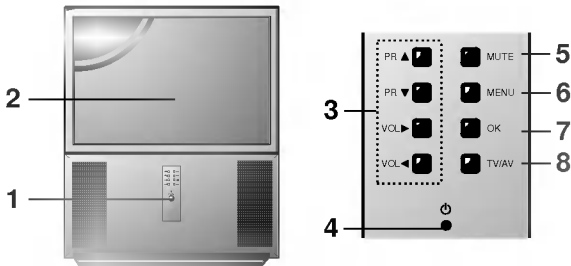

### • RT-44/49/54NZ23 series

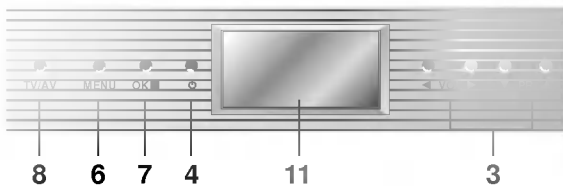
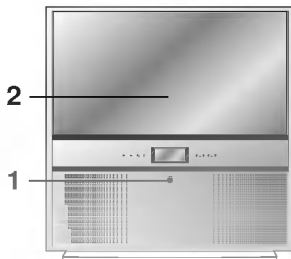

### • RT-40/45/56NZ60series

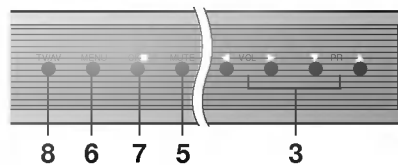
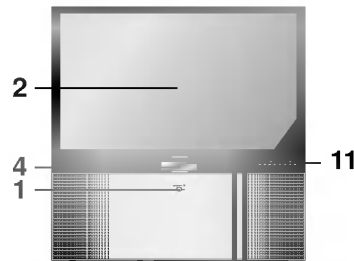

# Location and function of controls

## Front panel

### • RT-44/49/54A85 series

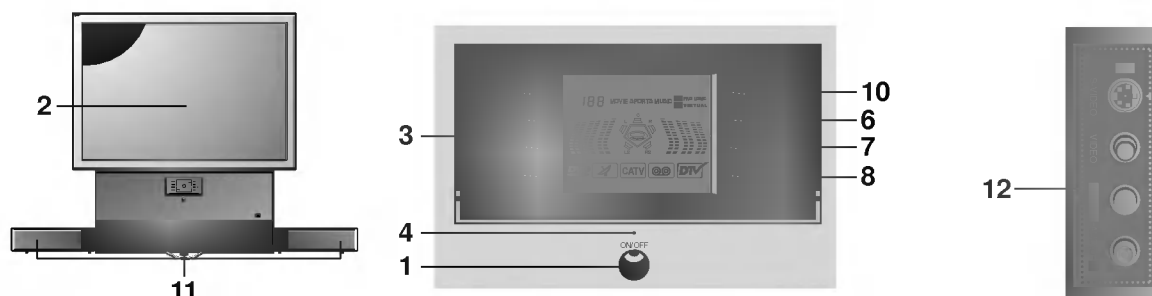

### • RT-39NZ43 series

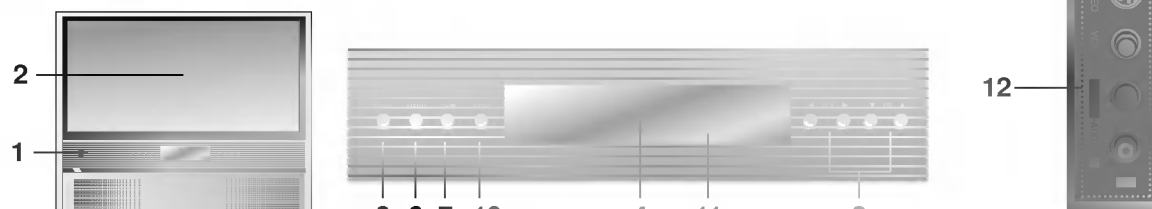

(Side panel)

1. **MAIN POWER**  
switches the set on or off.
  2. **REMOTE CONTROL SENSOR**
  3. **F / G (Volume Up/Down)**  
adjusts the volume.  
adjusts menu settings.  
**D / E (Programme Up/Down)**  
selects a programme or a menu item.  
switches the set on from standby.
  4. **POWER/STANDBY INDICATOR**  
illuminates brightly when the set is in standby mode.  
dims when the set is switched on.
  5. **MUTE**  
switches the sound on or off.
  6. **MENU**  
selects a menu.
  7. **OK**  
accepts your selection or displays the current mode.
  8. **TV/AV**  
selects TV or AV mode.  
clears the menu / text from the screen.  
switches the set on from standby.
  9. **LCD (Liquid Crystal Diode) DISPLAY**
  10. **INDEX**  
switches LED DISPLAY on or off.
  11. **LED (Light Emitting Diode) DISPLAY**  
illuminates brightly when the set is switched on.  
**Option** : Only RT-40NZ60 series,  

	: PAL/SECAM input signal indicator
	: NTSC input signal indicator
	: STEREO sound indicator
	: SLEEP timer indicator
	: CHILD LOCK setting indicator
  12. **AUDIO/VIDEO IN SOCKETS (AV3)**  
Connect the audio/video out sockets of external equipment to these sockets.  
**S-VIDEO/AUDIO IN SOCKETS (S-AV)**  
Connect the video out socket of an S-VIDEO VCR to the **S-VIDEO** socket.  
Connect the audio out sockets of the S-VIDEO VCR to the audio sockets as in **AV3**.
  13. **CENTRE SPEAKER (RT-48/53A82 series only)**  
**LEFT/RIGHT LOUD-SPEAKERS**  
Only in PT-49/54A85 series model, the left/right loud-speakers are detachable and need to be connected to the **SPEAKER OUT** sockets on the back panel of the set as indicated by red (+) and black (-) knobs.  
**Note** : Before placing the speakers, screw the speaker legs to the holes on them.
- \* **CASTERS (on the bottom)**  
turn and move the set easily.

---

## Basic operation

---

### On and off

1. Press the main power button to switch the set on.
2. If the set is in standby mode, press the **POWER**, **D / E**, **TV/AV** or **NUMBER** buttons on the remote control handset to switch it on fully.
3. Press the **POWER** button on the remote control handset.  
The set reverts to standby mode.
4. Press the main power button again to switch the set off.

**Note :** If, while the set is switched on, the mains plug is disconnected the set will switch to standby or power on when the mains plug is replaced in the mains power socket.

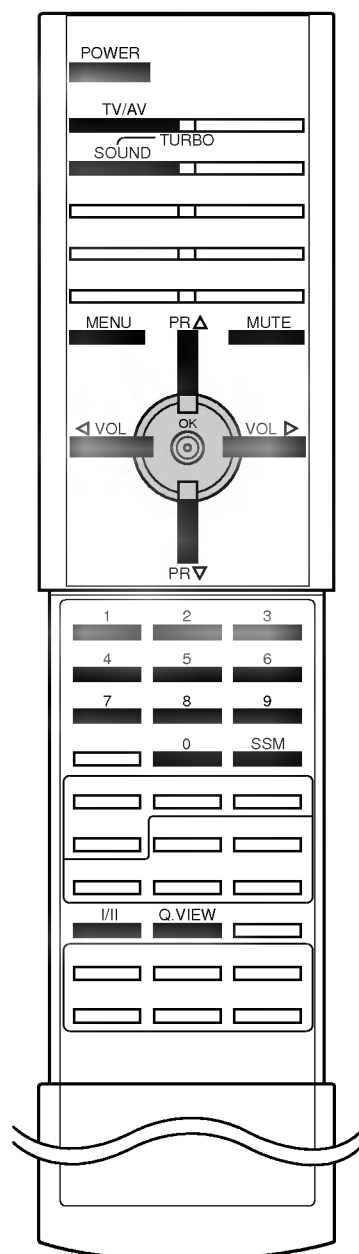

### Programme selection

You can select a programme number with the **D / E** or **NUMBER** buttons.

### Volume adjustment

Press the **F / G** button to adjust the volume.

**Note :** When the **TV** (speaker) is **On**, it's available.

### Quick view

Press the **Q.VIEW** button to view the last programme you were watching.

**Note :** This function works only when **Favourite programme** is set to **Off**. Otherwise each press of this button will select a stored favorite programme.

### Mute function

Press the **MUTE** button. The sound is switched off and the display  $\otimes$  appears.

You can cancel it by pressing the **MUTE**, **F / G**, **SSM**, **I/II**, **TURBO SOUND** button.

### Auto Demonstration

To review all the menus programmed in the set, press the **OK** button of the front panel control for about 5 seconds. To stop auto demonstration, press any button of the front panel control or **POWER** button of the remote control.

### On screen language selection (option)

The menu can be displayed on the screen in your desired language. First select your language.

1. Press the **MENU** button and then **D / E** button to select the Special menu.
2. Press the **G** button and then **D / E** button to select **Language**.
3. Press the **G** button and then **D / E** button to select your desired language.  
All the on screen displays will appear in the selected language. Press the **OK** or **F** button to select the Special menu.
4. Repeatedly press the **MENU** button to return to normal TV viewing.



## On screen menus

The dialogue between you and your set takes place on screen with an operator menu. The buttons required for the operating steps are also displayed.

### Menu selection

1. Press the **MENU** button and then **D / E** button to display each menu.
2. Press the **G** button and then **D / E** button to select a menu item.
3. Press the **G** button to display the sub menu or the pull-down menu.
4. Change the setting of an item in the sub or pull-down menu with **F / G** or **D / E**.

You can move to the higher level menu by pressing the **F** button and to move to the lower level menu by pressing the **G** button.

#### Note :

- a. In the teletext mode, menus are not displayed.
- b. In some models, the **Normal/Turbo search** will not display, only the **Start** will display in the **Auto programme** menu.
- c. On some models, the **Language** will not display.

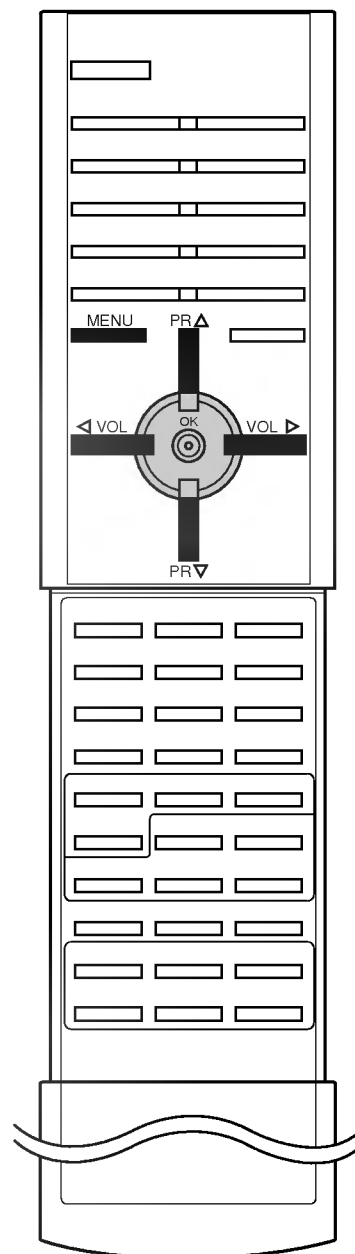
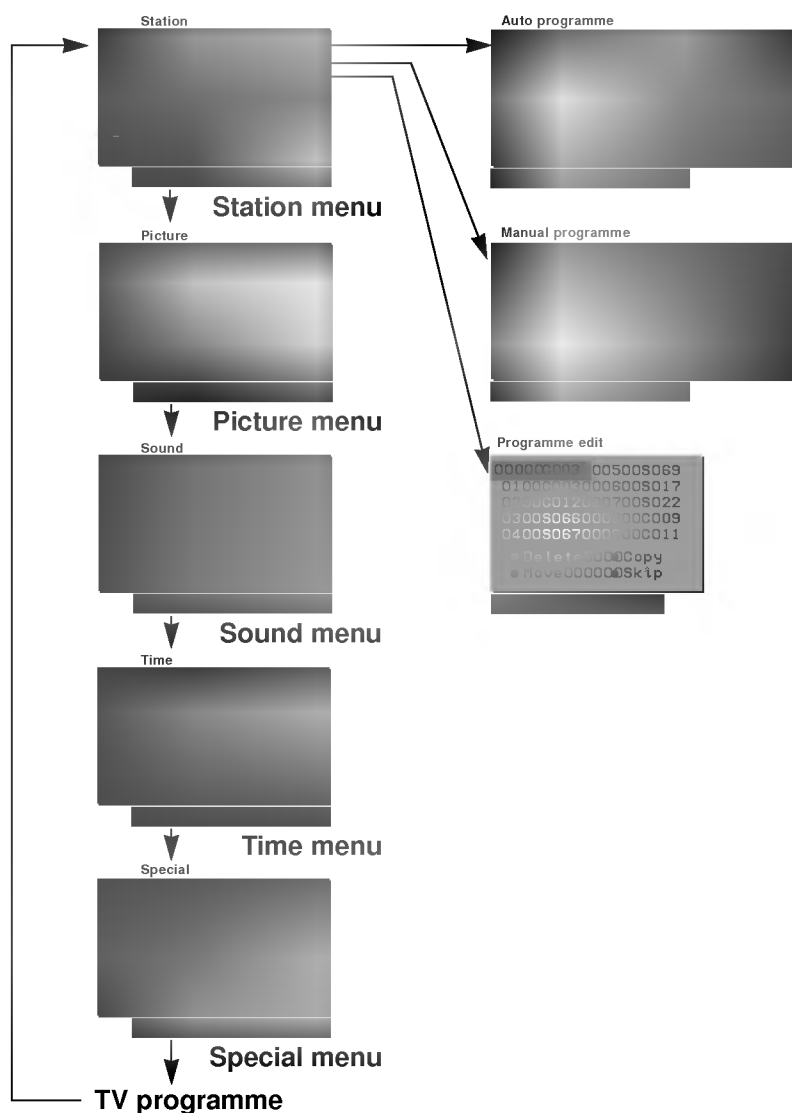

# Setting up TV stations

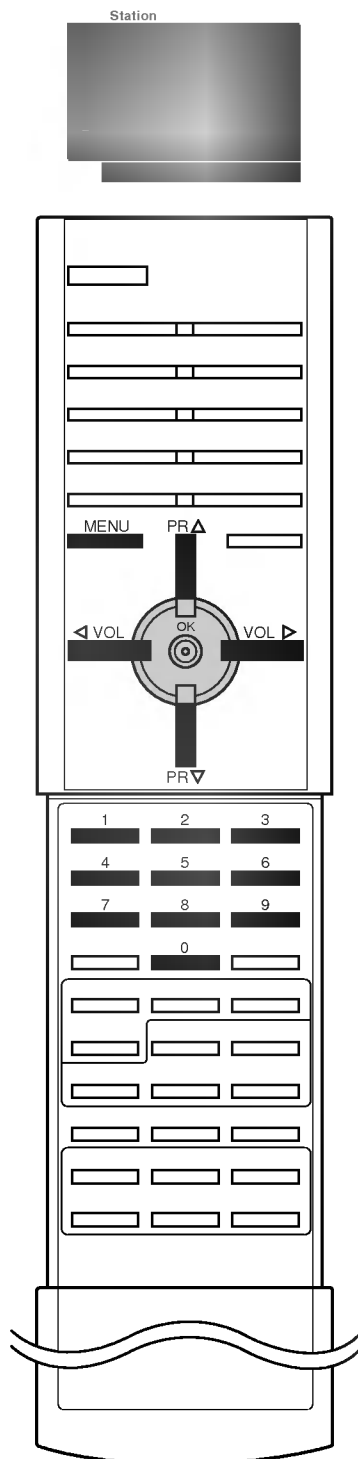

Up to 100 TV stations can be stored by programme numbers (0 to 99). Once you have preset the stations, you will be able to use the **D / E** or **NUMBER** buttons to scan the stations you have programmed. Stations can be tuned using automatic or manual modes.

**Note :** In some models up to 200 TV stations can be stored.

## Auto programme tuning

All stations that can be received are stored by this method. It is recommended that you use auto programme during installation of this set.

1. Press the **MENU** button and then **D / E** button to select the Station menu.
2. Press the **G** button and then **D / E** button to select **Auto programme**.
3. Press the **G** button to display the **Auto programme** menu.



4. Press the **G** button. Select a TV system with the **D / E** button on the **System** pull-down menu;
  - BG** : (Asia/New Zealand/M.East/Africa/Australia)
  - I** : (Hong Kong/South Africa)
  - DK** : (East Europe/China/Africa/CIS)
  - M** : (USA/Korea/Philippines) (option)
5. Press the **OK** or **F** button.
6. Press the **D / E** button to select **Storage from**.
7. Press the **G** button. Select the beginning programme number with the **F / G** button or **NUMBER** buttons on the **Storage from** pull-down menu. Any number under 10 is entered with a numeric '0' (or '00') in front of it, i.e. '05' (or '005') for 5.
8. Press the **OK** button.
9. Press the **D / E** button to select **Normal** or **Turbo search**.

**Note :**

- a. **Turbo search** is further faster than **Normal search** and in some models, these searches will automatically store all receivable stations.
  - b. If the programmed station has poor quality sound, select the system again in the **Manual programme** menu.
10. Press the **G** button to begin auto programming. All receivable stations are stored.

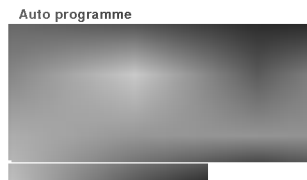

(Normal search)

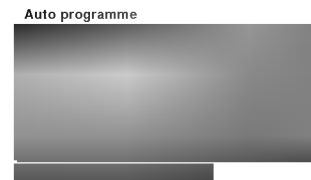

(Turbo search)

To stop auto programming, press the **MENU** button. When auto programming is completed, the **Programme edit** menu appears on the screen. See the 'Programme edit' section to edit the stored programme.

11. Repeatedly press the **MENU** button to return to normal TV viewing.

# Setting up TV stations

## Manual programme tuning

Manual programme lets you manually tune and arrange the stations in whatever order you desire. Also you can assign a station name with five characters to each programme number.

1. Press the **MENU** button and then **D / E** button to select the Station menu.
2. Press the **G** button and then **D / E** button to select **Manual programme**.
3. Press the **G** button to display the **Manual programme** menu.

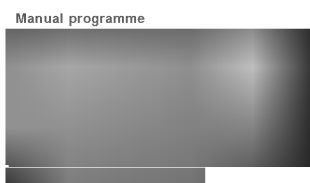

4. Press the **D / E** button to select **Storage**.
5. Press the **G** button to select the programme number. Select the desired programme number with the **F / G** button or **NUMBER** buttons on the **Storage** pull-down menu. Any number under 10 is entered with a numeric '0' (or '00') in front of it, i.e. '05' (or '005') for 5.
6. Press the **OK** button.
7. Press the **D / E** button to select **System**.
8. Press the **G** button. Select a TV system with the **D / E** button on the **System** pull-down menu;
  - BG** : (Asia/New Zealand/M.East/Africa/Australia)
  - I** : (Hong Kong/South Africa)
  - DK** : (East Europe/China/Africa/CIS)
  - M** : (USA/Korea/Philippines) (option)
9. Press the **OK** or **F** button.
10. Press the **D / E** button to select **Channel**.
11. Press the **G** button. Press the **D / E** button to select **V/UHF** or **Cable** on the **Channel** pull-down menu.
 

If possible, select the channel number directly with the number buttons. Any number under 10 is entered with a numeric '0' (or '00') in front of it, i.e. '05' (or '005') for 5.
12. Press the **OK** or **F** button.
13. Press the **D / E** button to select **Search**.
14. Press the **G** button. Press the **F / G** button to commence searching on the **Search** pull-down menu. If a station is found the search will stop.
15. Press the **OK** button to store it. The display **Stored** will appear.

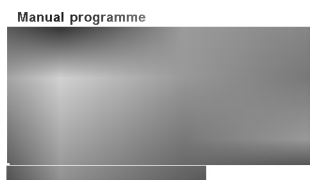

16. To store another station, repeat steps 4 to 15.
17. Repeatedly press the **MENU** button to return to normal TV viewing.

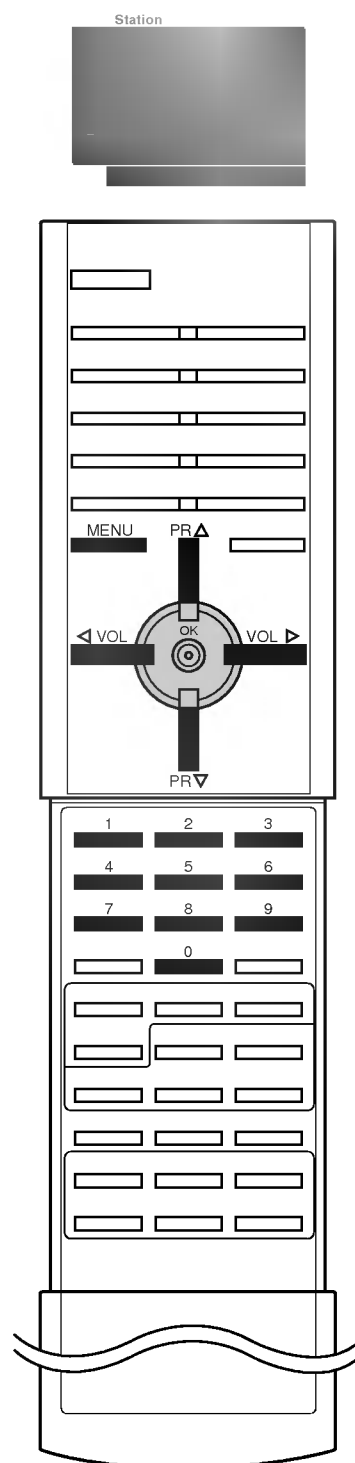

---

# Setting up TV stations

---

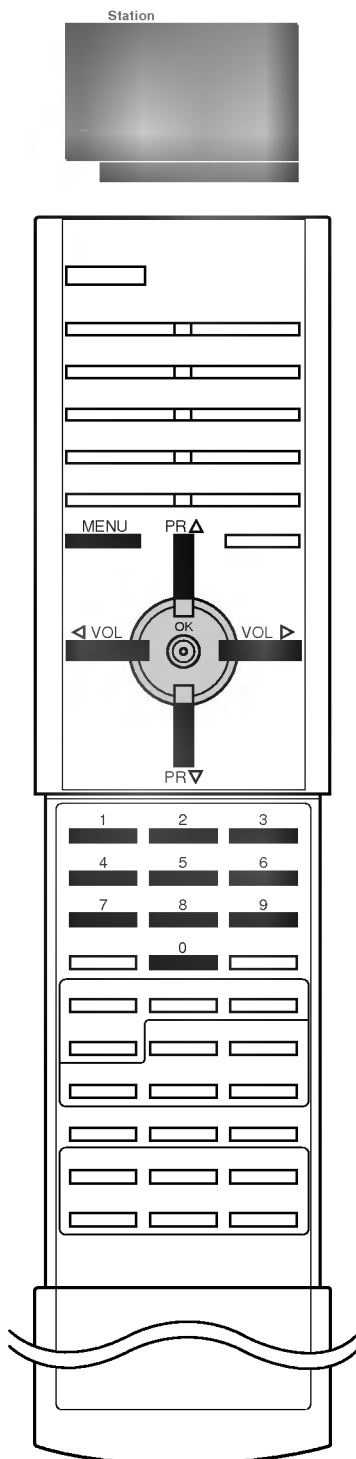

## Assigning a station name

1. Repeat the 'Manual programme tuning' steps 1 to 3.
2. Press the **D / E** button to select **Name**.
3. Press the **G** button on the **Name** pull-down menu.
4. Press the **D** button. You can use a blank, +, -, the numeric **0** to **9** and the alphabet **A** to **Z**.  
With the **E** button you can select in the opposite direction.
5. Select the position by pressing the **F / G** button and then make your choice of the second character, and so on.
6. Press the **OK** button.
7. Repeatedly press the **MENU** button to return to normal TV viewing.

## Booster (option)

In some models, **Booster** is an optional function. Only a set with **Booster** can perform this function.

If the reception is poor at the fringe area of TV signal, select **Booster to On**. When the picture condition is good, do not select **Booster to On**.

1. Repeat the 'Manual programme tuning' steps 1 to 3.
2. Press the **D / E** button to select **Booster**.
3. Press the **G** button.
4. Press the **D / E** button to select **On** or **Off** on the **Booster** pull-down menu.
5. Press the **OK** or **F** button.
6. Repeatedly press the **MENU** button to return to normal TV viewing.

## Fine tuning

Normally fine tuning is only necessary if reception is poor.

1. Repeat the 'Manual programme tuning' steps 1 to 3.
2. Press the **D / E** button to select **Fine**.
3. Press the **G** button.

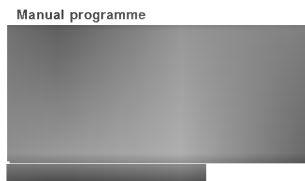

4. Press the **F / G** button to fine tune for the best picture and sound on the **Fine** pull-down menu.
5. Press the **OK** button.
6. Repeatedly press the **MENU** button to return to normal TV viewing.  
The finely tuned programme will be indicated by a yellow number during programme selection.

---

# Setting up TV stations

---

## Programme edit

This function enables you to delete or skip the stored programmes. Also you can move some stations to other programme numbers or insert a blank station data into the selected programme number.

1. Press the **MENU** button and then **D / E** button to select the Station menu.
2. Press the **G** button and then **D / E** button to select **Programme edit**.
3. Press the **G** button to display the **Programme edit** menu.

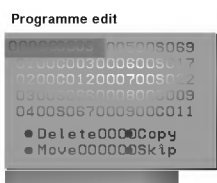

### Deleting a programme

1. Select a programme to be deleted with the **D / E** or **F / G** button.
2. Press the RED button twice.  
The selected programme is deleted, all the following programmes are shifted up one position.

### Copying a programme

1. Select a programme to be copied with the **D / E** or **F / G** button.
2. Press the GREEN button.  
All the following programmes are shifted down one position.

### Moving a programme

1. Select a programme to be moved with the **D / E** or **F / G** button.
2. Press the YELLOW button.
3. Move the programme to the desired programme number with the **D / E** or **F / G** button.
4. Press the YELLOW button again to release this function.

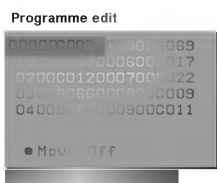

### Skipping a programme number

1. Select a programme number to be skipped with the **D / E** or **F / G** button.
2. Press the BLUE button. The skipped programme turns to blue.
3. Press the BLUE button again to release the skipped programme. When a programme number is skipped it means that you will be unable to select it using the **D / E** button during normal TV viewing. If you want to select the skipped programme, directly enter the programme number with the NUMBER buttons or select it in the programme edit or table menu.

Repeatedly press the **MENU** button to return to normal TV viewing.

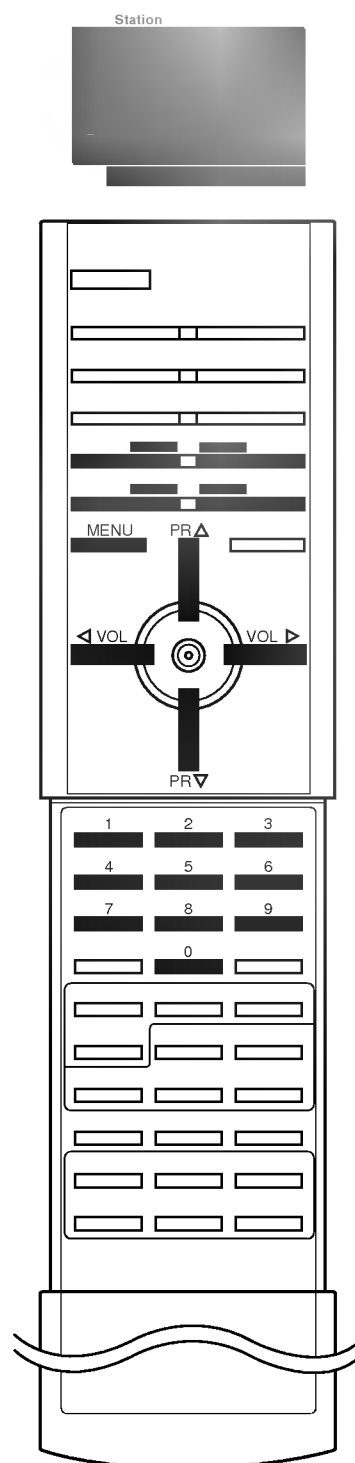

# Setting up TV stations

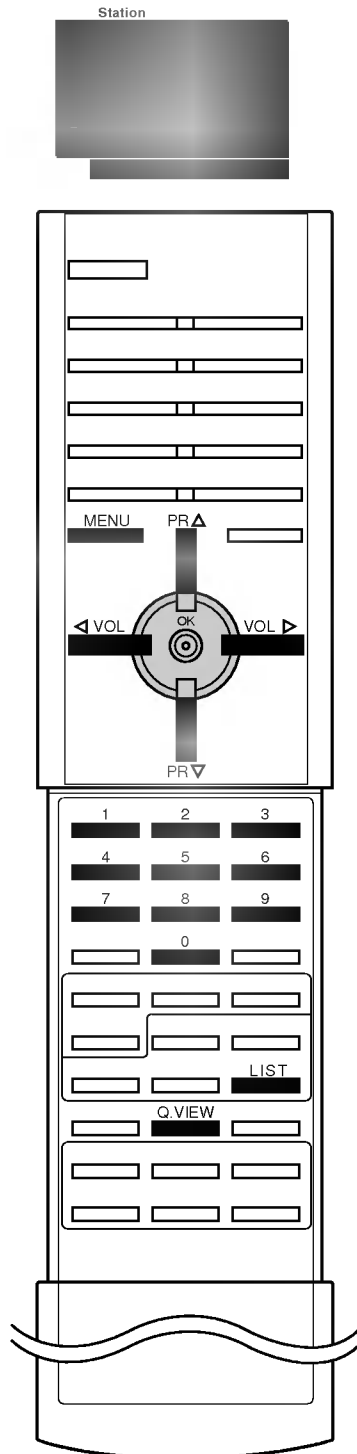

## Favourite programme

This function lets you select your favourite programmes directly.

1. Press the **MENU** button and then **D / E** button to select the Station menu.
2. Press the **G** button and then **D / E** button to select **Favourite programme**.
3. Press the **G** button.

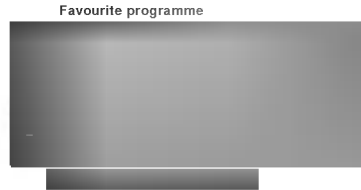

4. Press the **F / G** button to select **On** or **Off**.
5. Press the **D / E** button to select -- ----.
6. Select a desired programme with the **F / G** button or NUMBER buttons. Any number under 10 is entered with a numeric '0' (or '00') in front of it, i.e. '05' (or '005') for 5.
7. To store another programme, repeat steps 5 to 6. You can store up to 8 programmes.
8. Press the **OK** button.
9. Repeatedly press the **MENU** button to return to normal TV viewing.

Repeatedly press the **Q.VIEW** or **SWAP** button to select stored favourite programmes.

## Calling the programme table

You can check the programmes stored in the memory by displaying the programme table.

### Displaying programme table

Press the **LIST** button to display the **Programme table** menu. The programme table appears on the screen. One programme table contains ten programmes as below.



### Note :

- a. You may find some blue programmes. They have been set up to be skipped by auto programming or in the programme edit mode.
- b. Some programmes with the channel number shown in the programme table indicate there is no station name assigned.

### Selecting a programme in the programme table

Select a programme with the **D / E** or **F / G** button. Then press the **OK** button. The set switches to the chosen programme number.

### Paging through a programme table

There are 10 (or 20) programme table pages which contain 100 (or 200) programmes.

Pressing the **D / E** or **F / G** button repeatedly turns the pages.

Repeatedly press the **MENU** button to return to normal TV viewing.

---

# Picture adjustment

---

## PSM (Picture Status Memory)

1. Press the **MENU** button and then **D / E** button to select the Picture menu.
2. Press the **G** button and then **D / E** button to select **PSM**.
3. Press the **G** button and then **D / E** button to select a picture setting on the **PSM** pull-down menu.



4. Press the **OK** or **F** button.
5. Repeatedly press the **MENU** button to return to normal TV viewing.

You can also recall a desired picture (**Dynamic**, **Standard**, **Mild**, **Game** or **User**) with **PSM** button on the remote control. The picture **Dynamic**, **Standard**, **Mild** and **Game** are programmed for optimum picture reproduction at the factory and cannot be changed.

## DRPC (Digital Reality Picture Clarity)

1. Press the **MENU** button and then **D / E** button to select the Picture menu.
2. Press the **G** button and then **D / E** button to select **DRPC**.
3. Press the **G** button and then **D / E** button to select **On** or **Off** on the **DRPC** pull-down menu.
4. Press the **OK** or **F** button.
5. Repeatedly press the **MENU** button to return to normal TV viewing.

## VM (Velocity Modulation)

This is the function to enhance the sharpness of image edge.

1. Press the **MENU** button and then **D / E** button to select the Picture menu.
2. Press the **G** button and then **D / E** button to select **VM**.
3. Press the **G** button and then **F / G** button to adjust the vm.

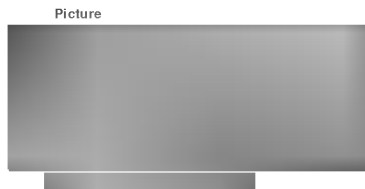

4. Press the **OK** button.
5. Repeatedly press the **MENU** button to return to normal TV viewing.

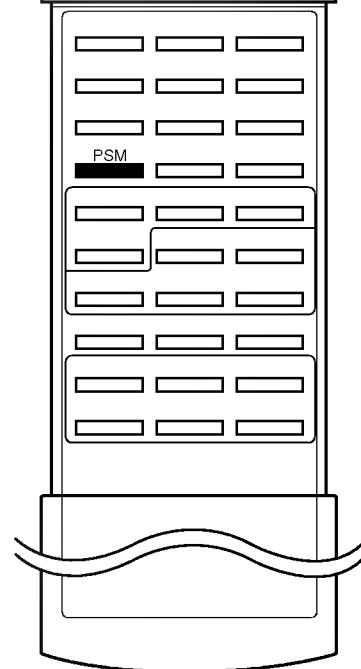
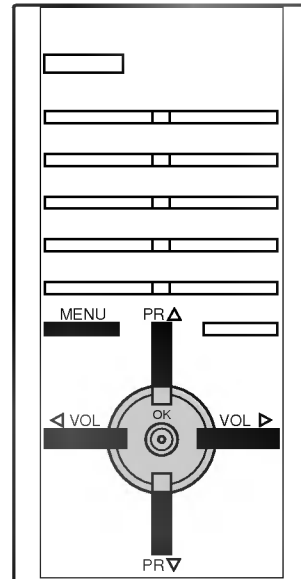
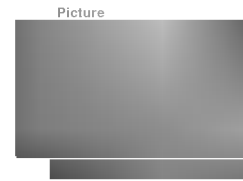

---

# Picture adjustment

---

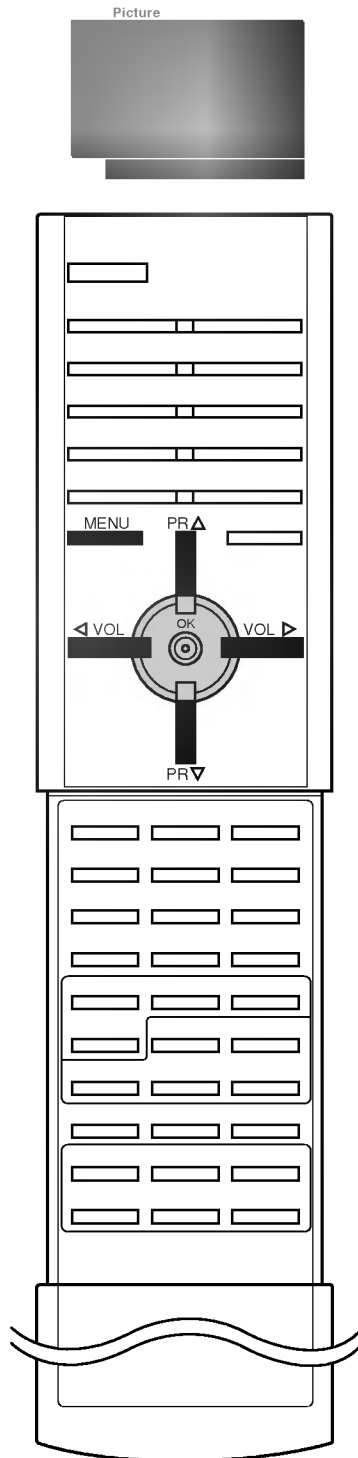

## Picture adjustment

You can adjust picture contrast, brightness, colour intensity, sharpness and tint (NTSC AV only) to the levels you prefer.

1. Press the **MENU** button and then **D / E** button to select the Picture menu.
2. Press the **G** button and then **D / E** button to select **Contrast, Brightness, Colour** or **Sharpness**.

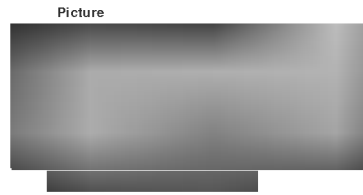

3. Press the **G** button and then **F / G** button to make appropriate adjustments on the each sub menu.



4. Press the **OK** button to store it for the picture user.
5. Repeatedly press the **MENU** button to return to normal TV viewing.



# Picture adjustment

## Convergence

This function enables you to adjust the colour convergence of screen all area or 9 points during receiving the signals. When the set is first installed or it is relocated, the picture may be unstable with three colour ghosts (red, green, blue). This problem can be solved by adjusting the colour convergence.

1. Press the **MENU** button and then **D / E** button to select the Picture menu.
2. Press the **G** button and then **D / E** button to select **Convergence**.
3. Press the **G** button and then **D / E** button to select **1** **+** (All point convergence) or **9** **+** (9 point convergence).



4. Press the **G** button.  
The display **DEFG** is selected in red.

If the display + are unstable with three colour ghosts, the colour convergence needs to be adjusted.

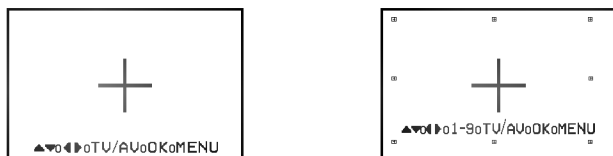

If the display + is white, colour convergence adjustment is not necessary.

5. Press the **TV/AV** button to select the display **DEFG** in blue.
6. **Only selection 9** **+**: Press the number (1 to 9) button to select the position you want to adjust the convergence.
7. Press the **D / E / F / G** button to superimpose the display + (red or blue) with the green one.  
The display + is moved to the left, right, up or down by pressing the **D / E / F / G** button.
8. If the red and blue display + are superimposed with the green one, the display + will be changed to yellow or cyan.
9. Press the **OK** button to store it for the convergence.
10. Repeatedly press the **MENU** button to return to normal TV viewing.

### Note :

- a. Press the **MENU** button to cancel the adjustment before saving.
- b. If the picture needs to be adjusted more after **1** **+** (All point convergence) adjustment, you can adjust the **9** **+** (9 point convergence) for the position you want to adjust.
- c. Adjust the convergence according to a broadcasting system (50Hz or 60Hz) each.

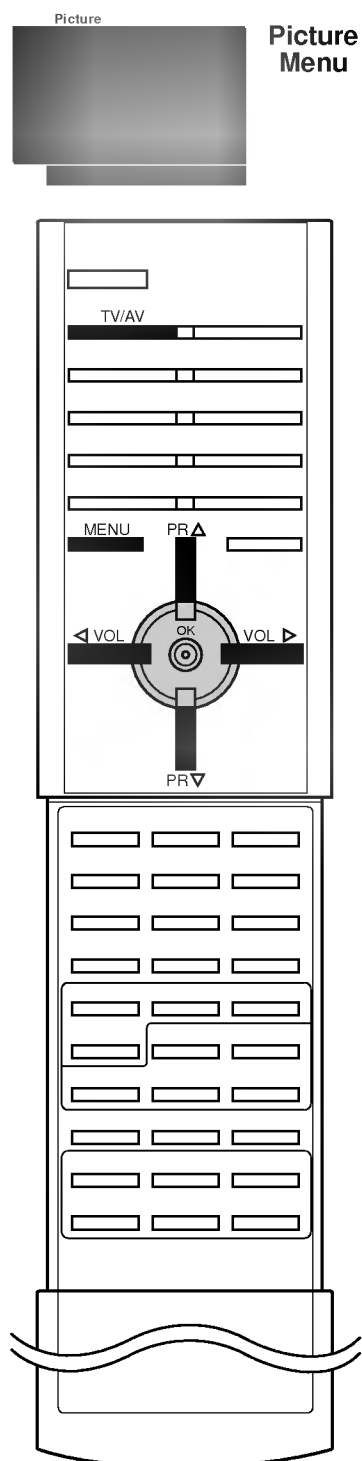

---

# Picture adjustment

---

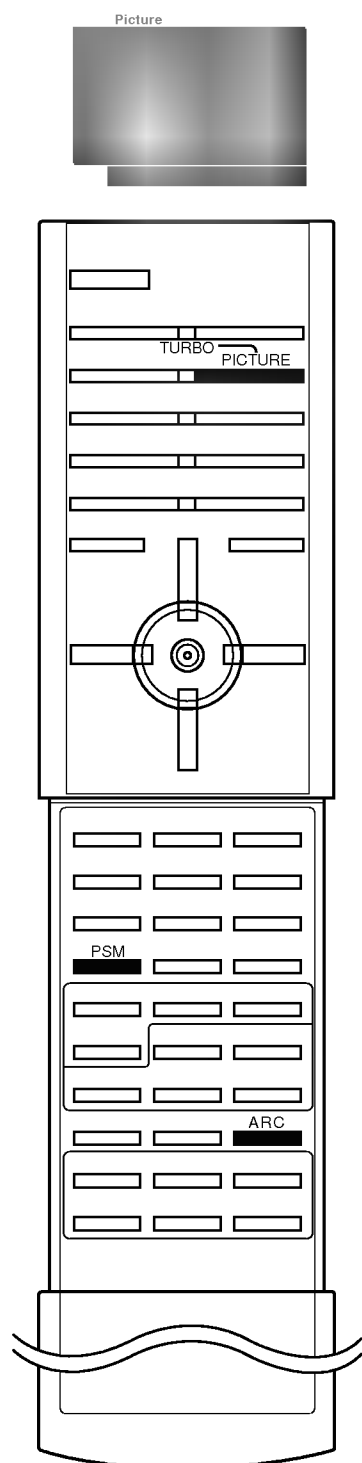

## Picture format

You can watch TV in various picture formats; 16:9, 14:9, Zoom, Auto and 4:3.

In some models, you can watch TV in various picture formats; 4:3 and 16:9.

Repeatedly press the **ARC** button to select your desired picture format.

### 4:3

This picture format is 4 to 3 of general TV.

### 16:9

You can enjoy the cinema (the picture format of 16:9) or general TV programme through the 16:9 mode.

### 14:9

The screen 14:9 is viewed just like that but the screen 4:3 is magnified to the upper / lower and left / right so that the screen 14:9 is full.

You can move the screen up or down with **D / E** button.

### Zoom

You can enjoy the cinema in a vast screen through the Zoom mode. The screen 4:3 is magnified to the upper/lower and left/right sides so that the screen 16:9 is full. The bottom and top of the picture may be lost.

You can move the screen up or down with **D / E** button.

### Auto

When your TV receives the wide screen signal, it will be automatically changed to the picture format to be sent.

*Note : In the double window, scan mode and Component 1080i, ARC function isn't available.*

## Turbo picture selection (option)

When this function is on, the picture will be more brilliant and distinct than normal. Repeatedly press the **TURBO PICTURE** button to switch on or off.

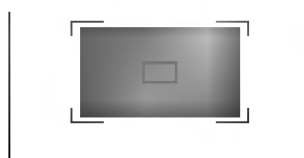

(Turbo Picture off)

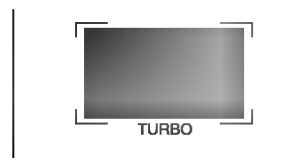

(Turbo Picture on)

*Note : If you press the PSM button with the Turbo picture function, the Turbo picture function is automatically switched off.*

---

# Sound adjustment

---

## SSM (Sound Status Memory)

You can select your preferred sound setting; Dolby Virtual (option), Flat, Music, Movie or Speech and you can also adjust the sound frequency of the equalizer.

1. Press the **MENU** button and then **D / E** button to select the Sound menu.
2. Press the **G** button and then **D / E** button to select **SSM**.
3. Press the **G** button and then **D / E** button to select a sound setting on the **SSM** pull-down menu.

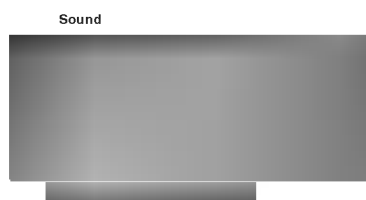

### Dolby Virtual (option)

Dolby Virtual lets you experience panoramic effects of sound.

### Sound Frequency Adjustment



- a. Press the **G** button in **User** to display the **User** sub menu.
- b. Select a sound band by pressing the **F / G** button.
- c. Select appropriate sound level with the **D / E** button.
- d. Press the **OK** button to store it for the sound **User**.

Repeatedly press the **MENU** button to return to normal TV viewing.

You can also recall a desired sound (**Dolby Virtual** (option), **Flat**, **Music**, **Movie**, **Speech** or **User**) with **SSM** button on the remote control. The sound **Dolby Virtual** (option), **Flat**, **Music**, **Movie** and **Speech** are programmed for optimum sound reproduction at the factory and cannot be changed.

**Note :** If you press the **SSM** button after making appropriate adjustment on the **User** sub menu, the display **User** automatically appears even though you have already set a factory preset setting; **Dolby Virtual** (option), **Flat**, **Music**, **Movie** or **Speech**.

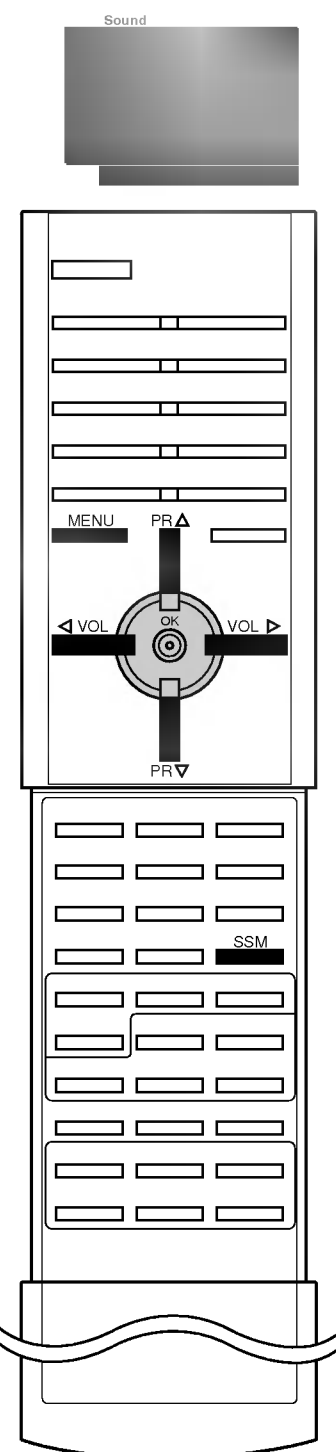

# Sound adjustment

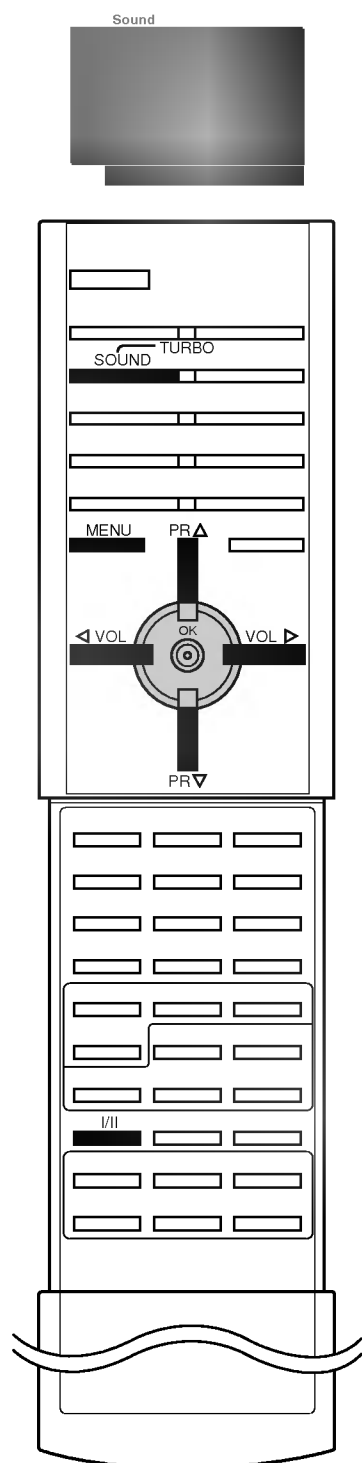

## Sound adjustment

You can adjust AVL (Auto Volume Leveler), DBS, TV Speaker or balance. AVL automatically keeps on the equal volume level even if you change programmes. If you switch DBS to on, the set creates a dynamic bass sound. The Turbo sound creates an all around sound as in a concert hall.

1. Repeatedly press the **MENU** button to select the Sound menu.
2. Press the **G** button and then **D / E** button to select the desired sound item ; **AVL, DBS, TV** (Speaker) or **Balance**



In the **AVL, DBS** and **TV** (Speaker) on the Sound menu, press the **D / E** button to select **On** or **Off**

In the **Balance** on the Sound menu, make desired adjustment with the **F / G** button on the **Balance** pull-down menu.

3. Repeatedly press the **MENU** button to return to normal TV viewing.

## Turbo sound selection (option)

When this function is on, the sound will be more emphasized and amplified than normal.

Repeatedly press the **TURBO SOUND** button to switch on or off.



(Turbo Sound off)



(Turbo Sound on)

## Sound output selection

In AV mode, you can select output sound for the left and right loud-speakers.

Repeatedly press the **I/II** button to select the sound output.

**L+R** : Audio signal from audio L input is sent to left loud-speaker and audio signal from audio R input is sent to right loud-speaker.

**L+L** : Audio signal from audio L input is sent to left and right loud-speakers.

**R+R** : Audio signal from audio R input is sent to left and right loud-speakers.

---

# Sound adjustment

---

## Stereo/Dual reception

When a programme is selected, the sound information for the station appears after the programme number and station name disappear.

Broadcast	On Screen Display
Mono	<b>MONO</b>
Stereo	<b>STEREO</b>
Dual	<b>DUAL I</b>

### Mono sound selection

In stereo reception if the stereo signal is weak, you can switch to mono by pressing the **I/II** button twice. In mono reception the depth of sound is improved. To switch back to stereo, press the **I/II** button twice again.

### Language selection for dual language broadcast

If a programme is received in two languages (dual language), you can switch to **DUAL I**, **DUAL II** or **DUAL I+II** by pressing the **I/II** button repeatedly.

**DUAL I** sends the primary broadcast language to the loudspeakers.

**DUAL II** sends the secondary broadcast language to the loudspeakers.

**DUAL I+II** sends a separate language to each loudspeaker.

### NICAM reception (option)

If your set is equipped with the receiver for NICAM reception, the high quality NICAM (Near Instantaneous Commanding Audio Multiplex) digital sound can be received.

Sound output can be selected according to the type of received broadcast as follows by pressing the **I/II** button repeatedly.

1. When NICAM mono is received, you can select **NICAM MONO** or FM MONO.
2. When NICAM stereo is received, you can select **NICAM STEREO** or FM MONO. If the stereo signal is weak, switch to FM mono.
3. When NICAM dual is received, you can select **NICAM DUAL I**, **NICAM DUAL II** or **NICAM DUAL I+II** or **MONO**. When FM mono is selected the display **MONO** appears on the screen.

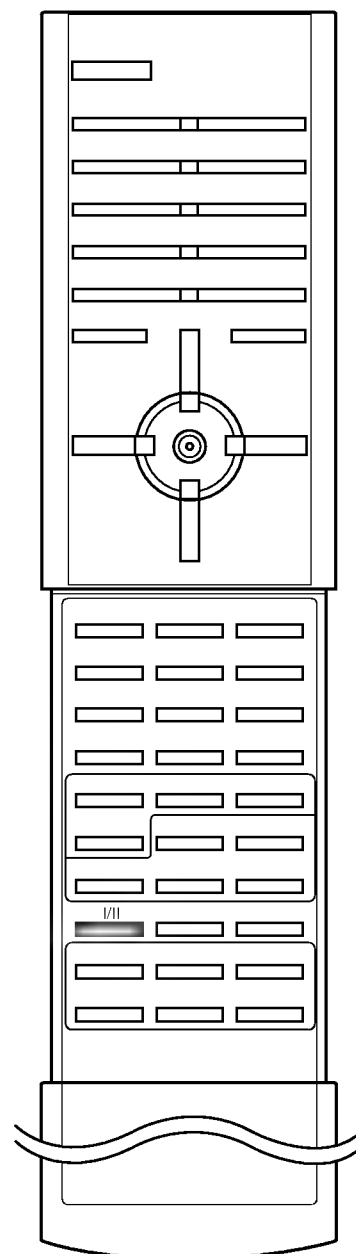

## Other functions

### TV and AV modes

Inputs can be set for TV or AV mode. AV mode is used when a video cassette recorder (VCR), or other equipment is connected to the set.

**Note :** When a VCR is connected via the aerial socket the set is used in TV mode. See the 'Connection of external equipment' section.

1. Press the **MENU** button and then **D / E** button to select the Special menu.
2. Press the **G** button and then **D / E** button to select **Input**.
3. Press the **G** button and then **D / E** button to select **TV, AV1, AV2, AV3, AV4, S-VIDEO4** (option), **COMPONENT 1, COMPONENT 2** or **VGA** (option) on the **Input** pull-down menu.

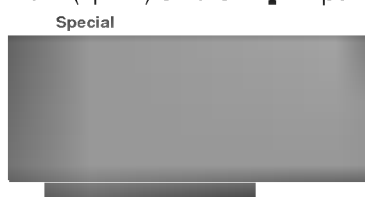

- AV1 : VCR connected to the **AV1** sockets on the set
- AV2 : VCR connected to the **AV2** sockets on the set
- AV3 : VCR connected to the **AV3** sockets on the set
- AV4 : VCR connected to the Euro scart socket on the set (option)
- S-VIDEO4 : S-VIDEO VCR connected to the Euro scart socket on the set (option)
- COMPONENT1/2 : COMPONENT connected to the **COMPONENT1/2** sockets on the set
- VGA : PC connected to the **PC (VGA)** sockets on the set (option)

4. Repeatedly press the **MENU** button to return to normal TV viewing.

Alternatively you can select the TV or AV mode by pressing the **TV/AV** button.

In AV mode, to return to TV mode, press the **D / E** or **NUMBER** buttons.

### VGA mode (option)

You can adjust picture contrast, brightness, convergence.

1. Press the **MENU** button and then **D / E** button to select the Special menu.
2. Press the **G** button and then **D / E** button to select **Input**.
3. Press the **G** button and then **D / E** button to select **VGA** on the **Input** pull-down menu.



4. Press the **MENU** button.
5. Press the **D / E** button to select **Contrast, Brightness, V-Position, H-Position** or **Convergence** on the VGA mode menu.

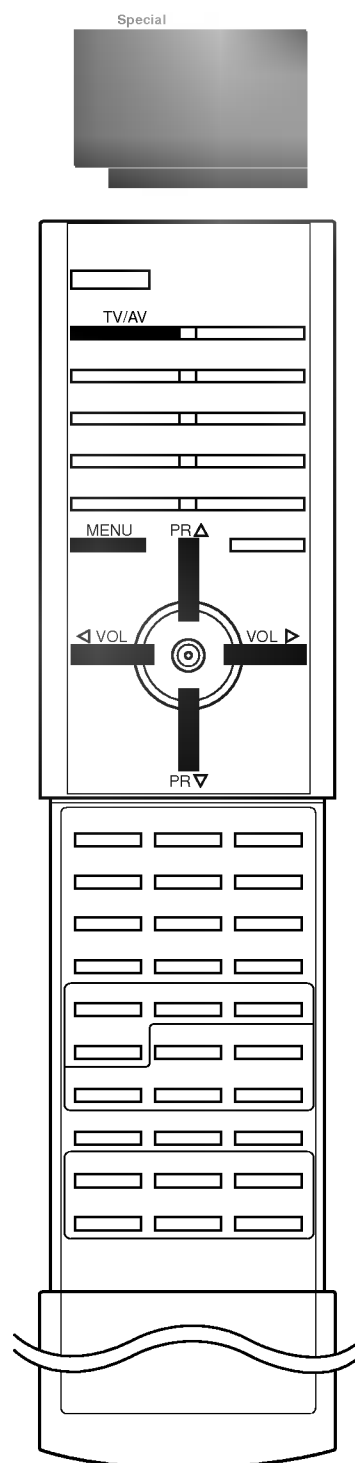

---

## Other functions

---

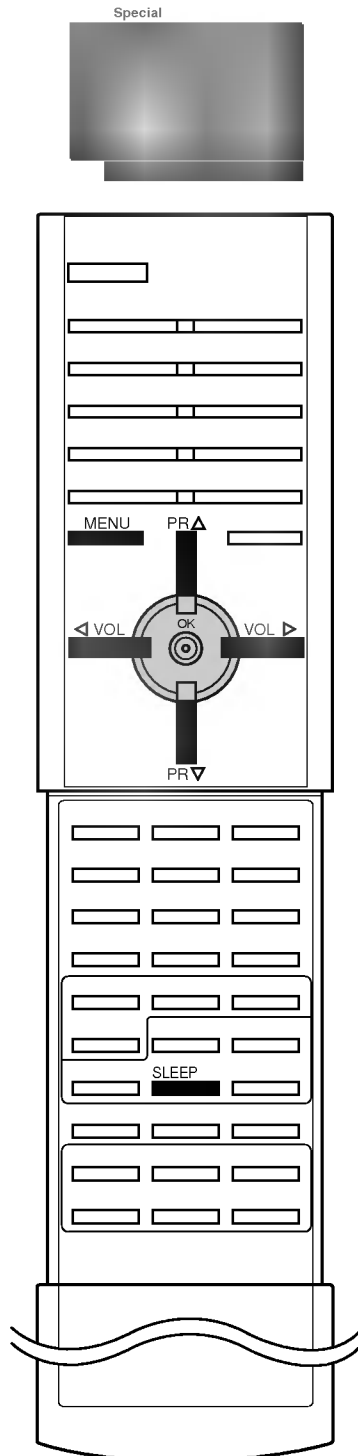

### Contrast

This function is to adjust the display to the contrast desired.

### Brightness

This function is to adjust the display to the brightness desired.

### Horizontal Position / Vertical Position

This function is to adjust picture to left/right and up/down as you prefer.

### Convergence

This function enables you to adjust the colour convergence of screen during receiving the signals.

**Note :** *The convergence isn't suitable to use in case of no PC cable signal.*

### Auto AV switching (option)

If your VCR outputs switching voltage when connected to the Euro scart socket, the set will switch to **AV4** mode automatically. But if you want to keep on watching TV mode, press the **D / E** or **NUMBER** buttons.

Press the **TV/AV** button to return to AV modes.

### Child lock

The TV can be set so that the remote control handset is needed to control it. This feature can be used to prevent unauthorized viewing.

1. Press the **MENU** button and then **D / E** button to select the Special menu.
2. Press the **G** button and then **D / E** button to select **Child lock**.
3. Press the **G** button and then **D / E** button to select **On** or **Off** on the **Child lock** pull-down menu.
4. Press the **OK** or **F** button.
5. Repeatedly press the **MENU** button to return to normal TV viewing.

With the lock on, the display **Child lock on** appears on the screen if any button on the front panel is pressed while viewing the TV.

**Note :** *The display **Child lock on** will not appear on the screen if any button on the front panel is pressed while displaying the menus.*

### Sleep timer

You don't have to remember to switch the set off before you go to bed. The sleep timer automatically switches the set to standby after the preset time elapses.

Press the **SLEEP** button to select the number of minutes. The display **⏰ ---** will appear on the screen, followed by **10, 20, 30, 60, 90, 120, 180** and **240**. The timer begins to count down from the number of minutes selected.

### Note :

- a. To view the remaining sleep time, press the **SLEEP** button once.
- b. To cancel the sleep time, repeatedly press the **SLEEP** button until the display **⏰ ---** appears.
- c. When you switch the set off, the set releases the preset sleep time.

---

## PIP operation (option)

---

### Option :

PIP is an optional function, so that only the set with PIP function can operate.

PIP (Picture in Picture) displays a picture within a picture.

### On and off

Press the **PIP** button to switch on the sub picture.  
press this button again to switch it off.

**Note :** In Component 1080i mode, PIP function isn't available.

### Input mode selection for sub picture

Press the **INPUT** button to select the input mode for the sub picture.

Each time this button is pressed, each input mode for the sub picture is displayed as shown below.

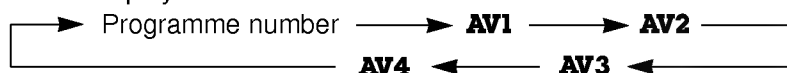

### Note :

- You can also adjust it in the Special menu.
- You can select the input mode for the sub picture, after connecting the external equipment.

### Swapping between main and sub pictures

Press the **SWAP** button to exchange the main and sub pictures.

### Programme selection for sub picture

Press the **PR +/-** buttons to select a programme for the sub picture.  
The selected programme number is displayed just below the programme number of main picture.

### Sub picture size

Repeatedly press the **SIZE** button to select the desired sub picture size. The sub picture appears as below.

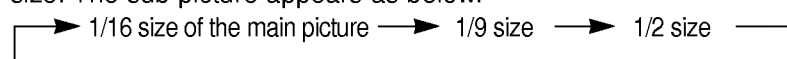

**Note :** If broadcasting system of the main picture for PIP is differ from sub picture's for PIP, the sub picture not be natural. (ex: In case that main picture/sub picture is PAL/NTSC system)

### Sub picture freeze

Press the **STILL** button to freeze motion of the sub picture.  
Press this button again to restore motion.

### Sub picture position change

Press the **POSITION** button repeatedly until desired position is achieved. The sub pictures move clockwise.

### Programme scan

This function enables you to search all the stored stations on 12 sub pictures and see your favorite station by exchanging the main and sub pictures.

Press the **SCAN** button to select 12 sub pictures.  
The selected sub pictures search all the stored stations.  
Press the **SCAN** button again to switch off sub pictures.

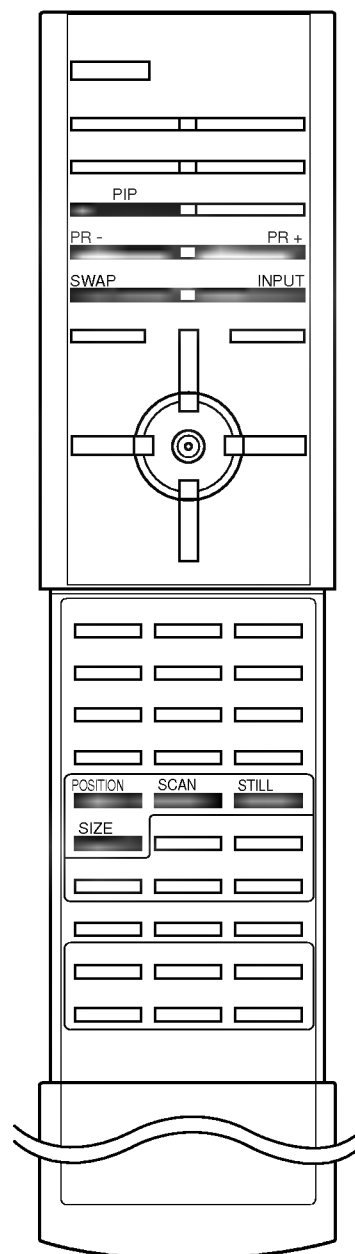



## Time setting

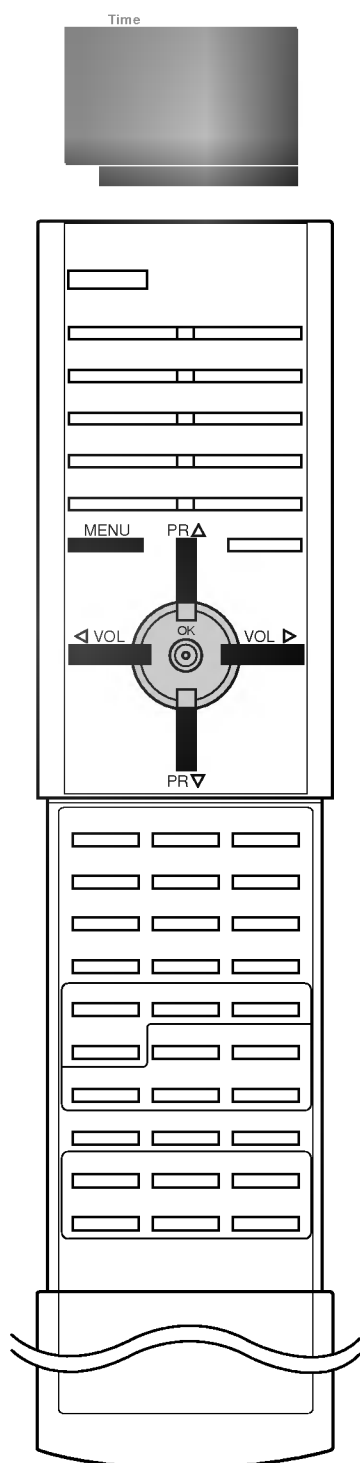

### Clock

1. Press the **MENU** button and then **D / E** button to select the Time menu.
2. Press the **G** button and then **D / E** button to select **Clock**.
3. Press the **G** button and then **D / E** button to adjust the hour.



4. Press the **G** button and then **D / E** button to adjust the minute.
5. Press the **OK** button.
6. Repeatedly press the **MENU** button to return to normal TV viewing.

### On/Off time

By using this function, the set automatically switches on or off at a preset time. You must set the time correctly before using on/off time function.

1. Press the **MENU** button and then **D / E** button to select the Time menu.
2. Press the **G** button and then **D / E** button to select **Off time/On time**.
3. Press the **G** button and then **D / E** button to adjust the hour.



4. Press the **G** button and then **D / E** button to adjust the minute.
5. **Only On time function**; Press the **G** button and then **D / E** button to adjust programme number and volume level.
6. Press the **OK** button.
7. Repeatedly press the **MENU** button to return to normal TV viewing.

#### Note :

- a. On time function works only in standby mode.
- b. To view the remaining on/off time, select the Time menu.
- c. When you switch the main power off, the **Clock** is reset.
- d. Two hours after the set is switched on by the on time function it will automatically switch back to standby mode unless a button has been pressed.
- e. Once the on or off time is set, these functions operate daily at the preset time.

### Auto sleep

If you select **On** on the **Auto Sleep** pull-down menu, the set will automatically switch itself to standby mode approximately ten minutes after a TV station stops broadcasting.

1. Press the **MENU** button and then **D / E** button to select the Time menu.
2. Press the **G** button and then **D / E** button to select **Auto Sleep**.
3. Press the **G** button and then **D / E** button to select **On** or **Off** on the **Auto Sleep** pull-down menu.
4. Press the **OK** or **F** button.
5. Repeatedly press the **MENU** button to return to normal TV viewing.

---

## Teletext (option)

---

Teletext (or TOP text) is an optional function, therefore only a set with the teletext system can receive the teletext broadcast.

Teletext is a free service broadcast by most TV stations which gives up-to-the-minute information on news, weather, television programmes, share prices and many other topics.

The teletext decoder of this TV can support the SIMPLE, TOP and FASTEXT systems. SIMPLE (standard teletext) consists of a number of pages which are selected by directly entering the corresponding page number. TOP and FASTEXT are more modern methods allowing quick and easy selection of teletext information.

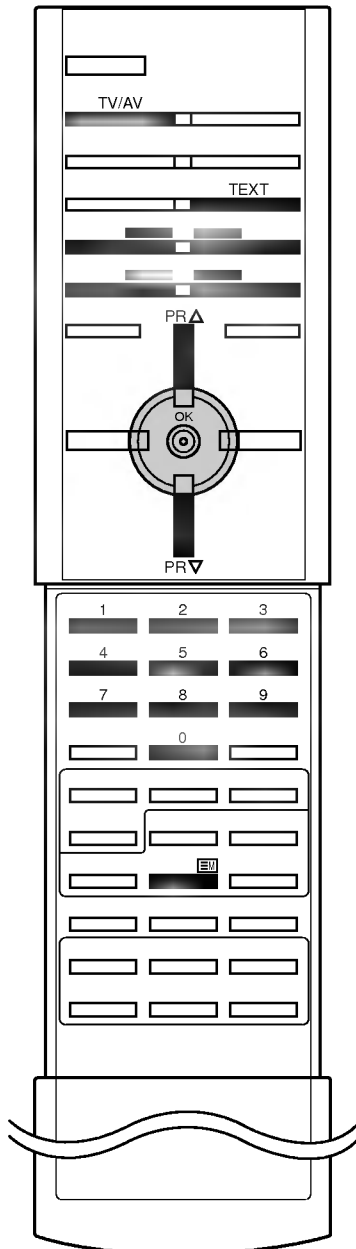

### Switch on/off

Press the **TEXT** button to switch to teletext. The initial page or last page appears on the screen.

Two page numbers, TV station name, date and time are displayed on the screen headline. The first page number indicates your selection, while the second shows the current page displayed.

Press the **TEXT** button to switch off teletext. The previous mode reappears.

### SIMPLE text

#### Page selection

1. Enter the desired page number as a three digit number with the **NUMBER** buttons. If during selection you press a wrong number, you must complete the three digit number and then re-enter the correct page number.
2. The **D / E** button can be used to select the preceding or following page.

#### Programming a colour button in LIST mode

If the TV is in SIMPLE text, TOP text or FASTEXT mode, press the **LIST** button to switch to LIST mode.

Four teletext page numbers of your choice can be colour coded and easily selected by pressing the corresponding coloured button on the remote control handset.

1. Press a coloured button.
2. Using the **NUMBER** buttons, select the page you wish to programme.
3. Press the **OK** button. Then the selected page is stored as the selected page number by blinking once. From now on, you can select this page with the same coloured button.
4. The three other coloured buttons are programmed in the same way.

---

# Teletext (option)

---

## TOP text (option)

The user guide displays four fields-red, green, yellow and blue at the bottom of the screen. The yellow field denotes the next group and the blue field indicates the next block.

### Block / group / page selection

1. With the blue button you can progress from block to block.
2. Use the yellow button to proceed to the next group with automatic overflow to the next block.
3. With the green button you can proceed to the next existing page with automatic overflow to the next group. Alternatively the **D** button can be used.
4. The red button permits to return to previous selection. Alternatively the **E** button can be used.

### Direct page selection

Corresponding to the SIMPLE teletext mode, you can select a page by entering it as a three digit number using the NUMBER buttons in TOP mode.

## FASTEXT

The teletext pages are colour coded along the bottom of the screen and are selected by pressing the corresponding coloured button.

### Page selection

1. Press the  button to select the index page.
2. You can select the pages which are colour coded along the bottom line with the same coloured buttons.
3. Corresponding to the SIMPLE teletext mode, you can select a page by entering its three digit page number with the NUMBER buttons in FASTEXT mode.
4. The **D** / **E** button can be used to select the preceding or following page.

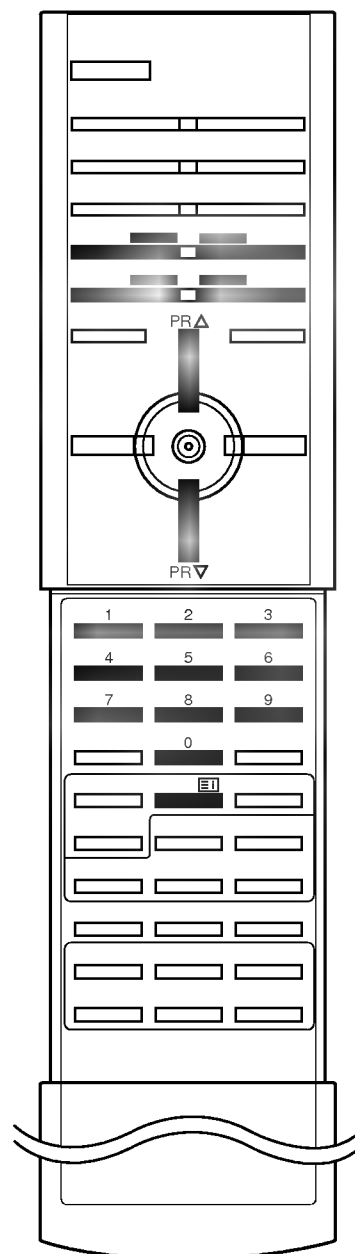

---

# Teletext (option)

---

## Special teletext functions

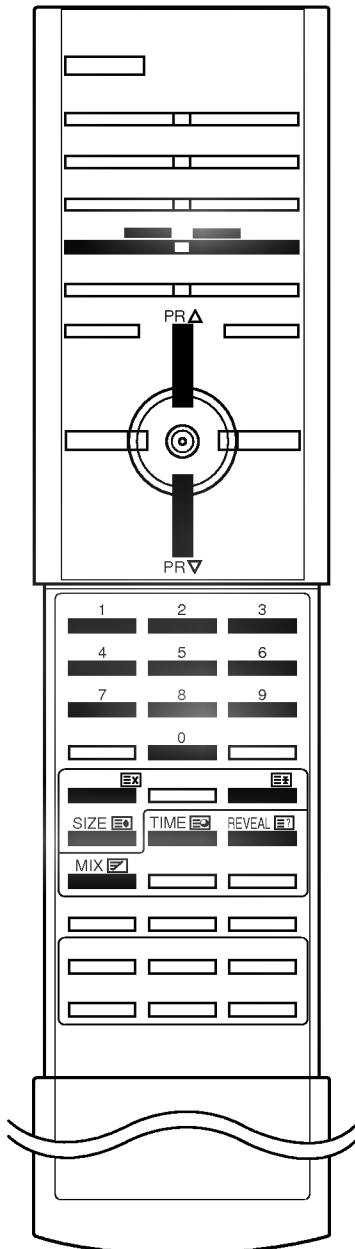

### REVEAL

Press this button to display concealed information, such as solutions of riddles or puzzles.

Press this button again to remove the information from the display.



### SIZE

Selects double height text.



Press this button to enlarge the top half of the page.

Press this button again to enlarge the bottom half of the page.

Press this button again to return to the normal display.



### UPDATE

Displays the TV picture on the screen while waiting for the new teletext page. The display  will appear at the top left hand corner of the screen. When the updated page is available then display  will change to the page number.

Press this button to view the updated teletext page.



### HOLD

Stops the automatic page change which will occur if a teletext page consists of 2 or more sub pages. The number of sub pages and the sub page displayed is, usually, shown on the screen below the time. When this button is pressed the stop symbol is displayed at the top left-hand corner of the screen and the automatic page change is inhibited.

To continue press this button again.



### MIX

Displays the teletext pages superimposed on the TV picture.

To switch the TV picture off press this button again.



### TIME

When viewing a TV programme, press this button to display the time at the top right hand corner of the screen. Press this button again to remove the display. In the teletext mode, press this button to select a sub page number. The sub page number is displayed at the bottom of the screen. To hold or change the sub page, press the RED / GREEN, **D** / **E** or NUMBER buttons.

Press this button again to exit this function.

---

## Connection of external equipment

---

You can connect additional equipment, such as VCRs, camcorders etc. to your set.

Here shown may be somewhat different from your set.

### Aerial socket

1. Connect the RF out socket of the VCR to the aerial socket on the back of the set.
2. Connect the aerial cable to the RF aerial in socket of the VCR.
3. Store the VCR channel on a desired programme number using the 'Manual programme tuning' section.
4. Select the programme number where the VCR channel is stored.
5. Press the **PLAY** button on the VCR.

### Euro scart socket (option)

1. Connect the Euro scart socket of the VCR to the Euro scart socket of the set.
2. Press the **PLAY** button on the VCR.  
If your VCR outputs a switching voltage connect to Euro scart socket, the set will switch to **AV 4** mode automatically. But if you want to keep on watching TV mode, press the **D / E** or **NUMBER** buttons.

Otherwise press the **TV/AV** button on the remote control handset to select **AV 4**. The VCR playback picture appears on the screen.

You can also record programmes received by the TV on video tape.

#### Note :

- a. Signal type RGB, i.e. the signals red, green and blue can only be selected for the Euro scart can be received. These signals are transmitted, for example, by a pay TV decoder, game machine or photo CD unit, etc.
- b. If Euro scart 4 socket has been connected to the VCRs simultaneously, only the **AV 4** can be received.
- c. If the set has been disconnected to the external equipment, only can be selected **AV 4**.

### Audio/Video in/out sockets (option)

1. Connect the audio/video out sockets of the VCR to audio/video in sockets of the set and in sockets of the VCR to out sockets of the set.
2. Press the **TV/AV** button to select **AV 1**, **AV 2** or **AV 3**.
3. Press the **PLAY** button on the VCR.  
The VCR playback picture appears on the screen.

You can also record programmes received by the TV on video tape via audio/video out sockets.

#### Note :

- a. If you have a mono VCR, connect the audio cable from the VCR to the **AUDIO L/MONO** socket of the set.
- b. When the set has been connected to the external equipment, you can select AV or COMPONENT modes with the remote control handset.

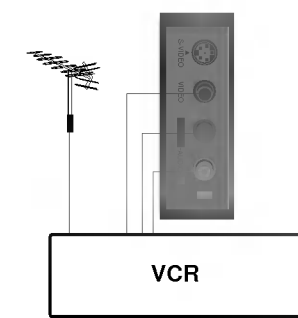
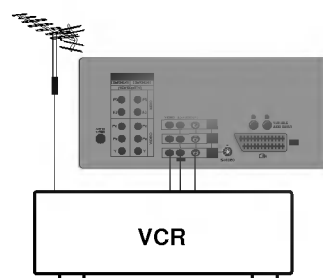
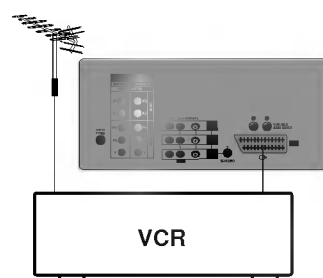
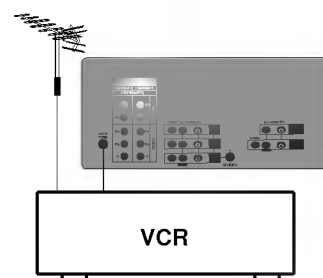
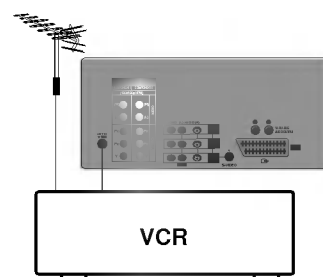

---

## Connection of external equipment

---

### S-Video / Audio in sockets (S-AV) (option)

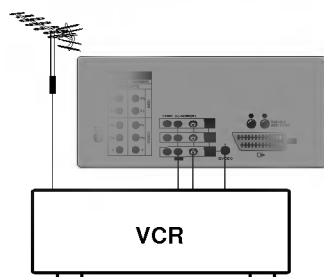

When connecting an VCR to the S-VIDEO socket, the picture quality will be further improved.

1. Connect the S-video socket of the VCR to the S-VIDEO socket of the set.
2. Connect the audio cable from the VCR to the AUDIO sockets of the set.
3. Select **AV1** or **AV3** by pressing the **TV/AV** button repeatedly.
4. Press the **PLAY** button on the VCR.  
The VCR playback picture appears on the screen.

**Note :** If both **S-VIDEO** and **VIDEO** sockets have been connected to the VCR simultaneously, only the **S-VIDEO** can be received.

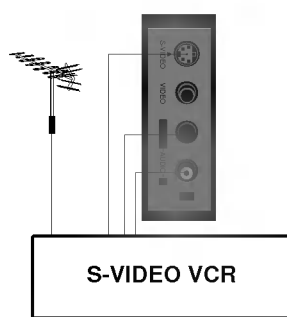

### Component in sockets

1. Connect the COMPONENT VIDEO output sockets (Y Cb Cr, Y Pb Pr, Y B-Y R-Y or Y P<sub>B</sub> P<sub>R</sub>) of the DVD player to the **DVD INPUT VIDEO** sockets (Y P<sub>B</sub> P<sub>R</sub>) of the set.
2. Connect the audio cable from the DVD player to **DVD INPUT AUDIO** sockets of the set.
3. Press the **TV/AV** button to select **COMPONENT1** or **COMPONENT2**.
4. Press the **PLAY** button on the DVD player.  
The DVD playback picture appears on the screen.

**Note :** DVD audio input can be output, but DVD video input cannot be output.

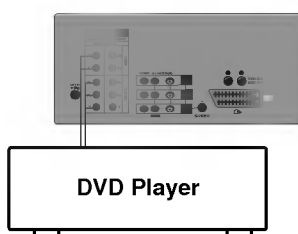

### Variable Audio out sockets (AUDIO OUT)

The phono sockets for a Hi-Fi amplifier system are on the back of the set; L=left sound channel, R=right sound channel.

If you connect an amplifier system, you can also play the TV sound through the stereo amplifier system. TV speaker and external speakers muted when pressing the **MUTE** button.

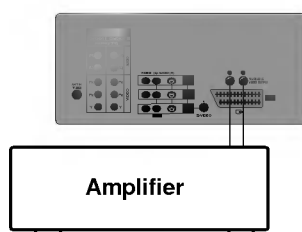

---

## Connection of external equipment

---

### Monitor out sockets

Connect the audio/video in sockets of the other TV or monitor to **MONITOR OUTPUT** sockets of the set.

### PC Input/Audio in sockets (option)

1. Connect the PC cable from the monitor output socket of the PC to the PC INPUT sockets of the set.
2. Connect the audio cable from the PC to the **AUDIO** sockets of the set.
3. Switch on the PC, and the PC screen appears on the set. The set can be operated as the PC monitor.

*Note :*

- a. *The cables are not supplied, such as the PC cable, audio cable etc.*
- b. *Set the resolution of PC to VGA 640x480 (60 Hz) video mode to use this set as PC monitor.*

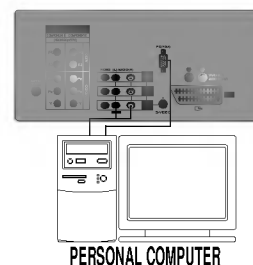
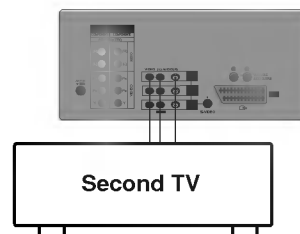

### Displayable Monitor Specification (only)

MODE	Resolution	Horizontal Frequency(KHz)	Vertical Frequency(Hz)
VGA	640x480	31.5KHz	60Hz

(Synchronization input form : separate)

---

# Troubleshooting check list

---

## Symptoms

No picture, no sound

Sound OK, poor picture

Picture OK, poor sound

Picture blurred

Lines or streaks in picture

Poor reception on some channels

No colour

Poor colour

Remote control does not work

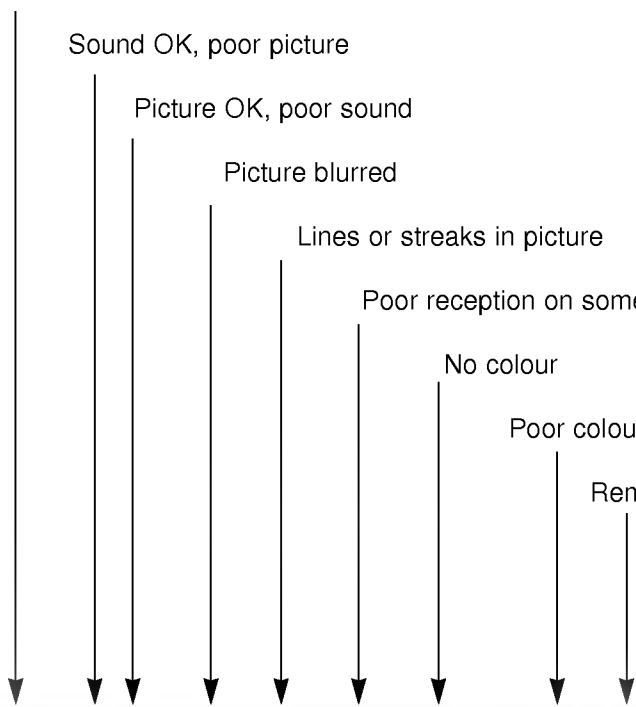
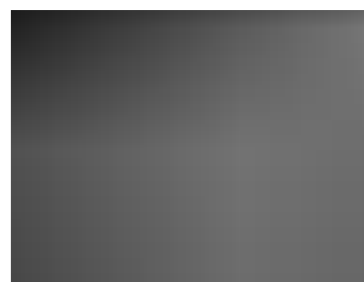

### Check these items and try to adjust these

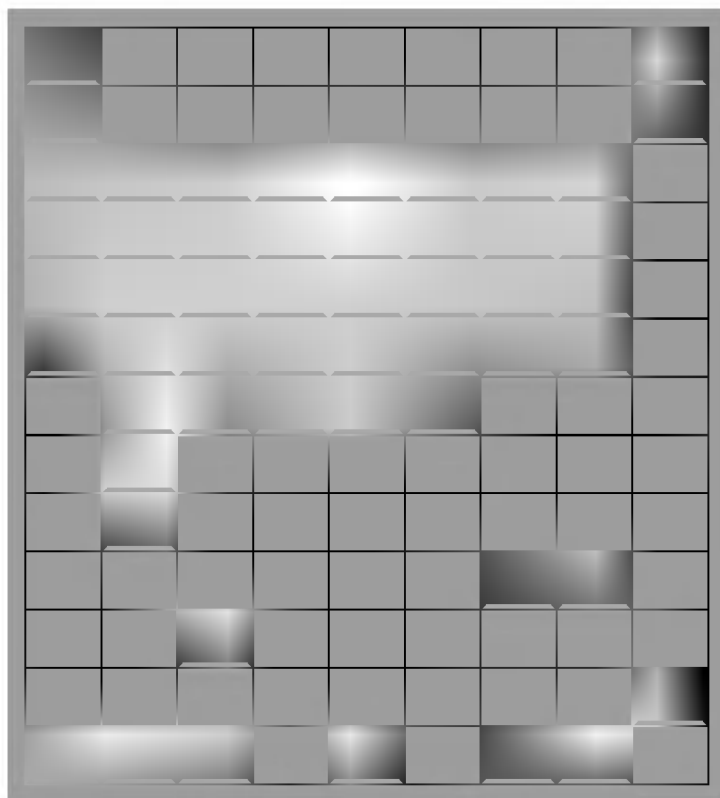

- The mains plug-(plugged in and switched on)
- Is the TV switched on
- Try another channel (weak signal)
- Check aerial (plugged into TV?)
- Check aerial (broken lead?)
- Check aerial
- Check for local interference
- Adjust contrast
- Adjust brightness
- Adjust colour
- Adjust volume
- Check the batteries in remote control
- Check Audio/Video sockets (VCR only)