

Operating Guide | Warranty

Model Numbers | L17W36, L23W36 | LCD TV/Monitor



Warning



CAUTION
RISK OF ELECTRIC SHOCK
DO NOT OPEN



WARNING:

TO REDUCE THE RISK OF ELECTRIC SHOCK DO NOT REMOVE COVER (OR BACK). NO USER SERVICEABLE PARTS INSIDE. REFER TO QUALIFIED SERVICE PERSONNEL.



The lightning flash with arrowhead symbol, within an equilateral triangle, is intended to alert the user to the presence of uninsulated "dangerous voltage" within the product's enclosure that may be of sufficient magnitude to constitute a risk of electric shock to persons.



The exclamation point within an equilateral triangle is intended to alert the user to the presence of important operating and maintenance (servicing) instructions in the literature accompanying the appliance.

WARNING:

TO PREVENT FIRE OR SHOCK HAZARDS, DO NOT EXPOSE THIS PRODUCT TO RAIN OR MOISTURE.

NOTE TO CABLE/TV INSTALLER:

This reminder is provided to call the CATV system installer's attention to Article 820-40 of the National Electric Code (U.S.A.). The code provides guidelines for proper grounding and, in particular, specifies that the cable ground shall be connected to the grounding system of the building, as close to the point of the cable entry as practical.

REGULATORY INFORMATION

This equipment has been tested and found to comply with the limits for a Class B digital device, pursuant to Part 15 of the FCC Rules. These limits are designed to provide reasonable protection against harmful interference in a residential installation. This equipment generates, uses and can radiate radio frequency energy and, if not installed and used in accordance with the instructions, may cause harmful interference to radio communications. However, there is no guarantee that interference will not occur in a particular installation. If this equipment does cause harmful interference to radio or television reception, which can be determined by turning the equipment off and on, the user is encouraged to try to correct the interference by one or more of the following measures:

- Reorient or relocate the receiving antenna.
- Increase the separation between the equipment and receiver.
- Connect the equipment into an outlet on a circuit different from that to which the receiver is connected.
- Consult the dealer or an experienced radio/TV technician for help.

Any changes or modifications not expressly approved by the party responsible for compliance could void the user's authority to operate the equipment.

CAUTION:

Do not attempt to modify this product in any way without written authorization from LG Electronics. Unauthorized modification could void the user's authority to operate this product.

COMPLIANCE:

The responsible party for this product's compliance is:

Zenith Electronics Corporation

1-201-816-2000

Marked and Distributed in the United States by LG Electronics U.S.A., Inc.

1000 Sylvan Avenue, Englewood Cliffs, NJ 07632

<http://www.zenith.com>

Safety Instructions

Important safeguards for you and your new product

Your product has been manufactured and tested with your safety in mind. However, improper use can result in potential electrical shock or fire hazards. To avoid defeating the safeguards that have been built into your new product, please read and observe the following safety points when installing and using your new product, and save them for future reference.

Observing the simple precautions discussed in this booklet can help you get many years of enjoyment and safe operation that are built into your new product.

This product complies with all applicable U.S. Federal safety requirements, and those of the Canadian Standards Association.

1. Read Instructions

All the safety and operating instructions should be read before the product is operated.

2. Follow Instructions

All operating and use instructions should be followed.

3. Retain Instructions

The safety and operating instructions should be retained for future reference.

4. Heed Warnings

All warnings on the product and in the operating instructions should be adhered to.

5. Cleaning

Unplug this product from the wall outlet before cleaning. Do not use liquid cleaners or aerosol cleaners. Use a damp cloth for cleaning.

6. Water and Moisture

Do not use this product near water, for example, near a bath tub, wash bowl, kitchen sink, or laundry tub, in a wet basement, or near a swimming pool.

7. Accessories Carts and Stands

Do not place this product on a slippery or tilted surface, or on an unstable cart, stand, tripod, bracket, or table. The product may slide or fall, causing serious injury to a child or adult, and serious damage to the product. Use only with a cart, stand, tripod, bracket, or table recommended by the manufacturer, or sold with the product. Any mounting of the product should follow the manufacturer's instructions, and should use a mounting accessory recommended by the manufacturer.

8. Transporting Product

A product and cart combination should be moved with care. Quick stops, excessive force, and uneven surfaces may cause the product and cart combination to overturn.

9. Attachments

Do not use attachments not recommended by the product manufacturer as they may cause hazards.

10. Ventilation

Slots and openings in the cabinet are provided for ventilation and to ensure reliable operation of the product and to protect it from overheating, and these openings must not be blocked or covered. The openings should never be blocked by placing the product on a bed, sofa, rug, or other similar surface. This product should not be placed in a built-in installation such as a bookcase or rack unless proper ventilation is provided or the manufacturer's instructions have been adhered to.

11. Power Sources

This product should be operated only from the type of power source indicated on the marking label. If you are not sure of the type of power supply to your home, consult your product dealer or local power company. For products intended to operate from battery power, or other sources, refer to the operating instructions.

12. Power-Cord Polarization

This product is equipped with a three-wire grounding type plug, a plug having a third (grounding) pin. This plug will only fit into the grounding-type power outlet. This is a safety feature. If you are unable to insert the plug into the outlet, contact your electrician to replace your obsolete outlet. Do not defeat the safety purpose of the grounding-type plug.

13. Power-Cord Protection

Power-supply cords should be routed so that they are not likely to be walked on or pinched by items placed upon or against them, paying particular attention to cords at plugs, convenience receptacles, and the point where they exit from the product.



PORTABLE CART WARNING

Safety Instructions continued

14. Outdoor Antenna Grounding

If an outside antenna or cable system is connected to the product, be sure the antenna or cable system is grounded so as to provide some protection against voltage surges and built-up static charges. Article 810 of the National Electrical Code (U.S.A.), ANSI/ NFPA 70 provides information with regard to proper grounding of the mast and supporting structure, grounding of the lead-in wire to an antenna discharge unit, size of grounding conductors, location of antenna-discharge unit, connection to grounding electrodes, and requirements for the grounding electrode.

Example of Grounding According to National Electrical Code Instructions

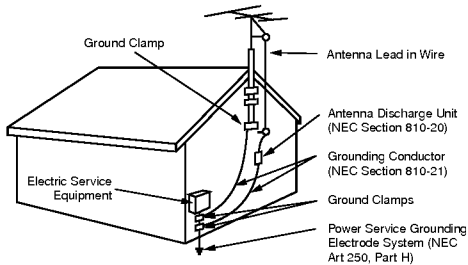

NEC - National Electrical Code

15. Lightning

For added protection for this product (receiver) during a lightning storm, or when it is left unattended and unused for long periods of time, unplug it from the wall outlet and disconnect the antenna or cable system. This will prevent damage to the product due to lightning and power-line surges.

16. Power Lines

An outside antenna system should not be located in the vicinity of overhead power lines or other electric light or power circuits, or where it can fall into such power lines or circuits. When installing an outside antenna system, extreme care should be taken to keep from touching such power lines or circuits as contact with them might be fatal.

17. Overloading

Do not overload wall outlets and extension cords as this can result in a risk of fire or electric shock.

18. Object and Liquid Entry

Never push objects of any kind into this product through openings as they may touch dangerous voltage points or short-out parts that could result in a fire or electric shock. Never spill liquid of any kind on the product.

19. Servicing

Do not attempt to service this product yourself as opening or removing covers may expose you to dangerous voltage or other hazards. Refer all servicing to qualified service personnel.

20. Damage Requiring Service

Unplug this product from the wall outlet and refer servicing to qualified service personnel under the following conditions:

- If the power-supply cord or plug is damaged.
- If liquid has been spilled, or objects have fallen into the product.
- If the product has been exposed to rain or water.
- If the product does not operate normally by following the operating instructions. Adjust only those controls that are covered by the operating instructions as an improper adjustment of other controls may result in damage and will often require extensive work by a qualified technician to restore the product to its normal operation.
- If the product has been dropped or the cabinet has been damaged.
- If the product exhibits a distinct change in performance.

21. Replacement Parts

When replacement parts are required, be sure the service technician has used replacement parts specified by the manufacturer or have the same characteristics as the original part. Unauthorized substitutions may result in fire, electric shock, or other hazards.

22. Safety Check

Upon completion of any service or repairs to this product, ask the service technician to perform safety checks to determine that the product is in proper operating condition.

23. Wall or Ceiling Mounting

The product should be mounted to a wall or ceiling only as recommended by the manufacturer. The product may slide or fall, causing serious injury to a child or adult, and serious damage to the product.

24. Heat

The product should be situated away from heat sources such as radiators, heat registers, stoves, or other products (including amplifiers) that produce heat.

Contents

Warnings	2	Stereo/SAP Broadcasts Setup	20
Safety Instructions	3~4	Time Menu Options	
Introduction		Auto Clock Setup	21
Controls and Connection Options	6~7	Manual Clock Setup	21
Remote Control Key Functions	8	On/Off Timer Setup	22
Installation		Sleep Timer Setup	22
Accessories / Power Connections	9	Special Menu Options	
Kensington Security System	9	Closed Captions	23
Installation Instruction	10	Captions	24
External Equipment Connections	11~14	Caption/Text	24
Antenna Connection	11	Key Lock	24
VCR Setup	12	Auto Off	24
Cable TV Setup	12	Lock Menu Options	
External A/V Source Setup	12	Lock Menu Setup	26
DVD Setup	13	RGB-PC Menu Options	
DTV Setup	13	Auto Config. Adjustment	27
Using Headphones	13	Horizontal/Vertical Position Adjustments	27
PC Setup	14	Phase/Clock Adjustments	27
Operation		PIP (Picture-in-Picture) Feature	
TV Operation Overview	15	Watching PIP/Double Window	28
Menu Language Selection	15	TV Program Selection for PIP	28
Channel Menu Options		Using PIP Still Function	28
Memorizing the Channels with EZ Scan	16	PIP Size	28
Add/Delete Channels with Ch.edit	16	Moving the PIP	28
Fine Tuning Adjustment	16	Swapping the PIP	29
Favorite Channels Setup	16	Selecting an Input Signal Source for PIP	29
Picture Menu Options		POP (Picture-out-of-Picture: Channel Scan)	29
EZ Video	17	Troubleshooting Checklist	30
Manual Picture Control	17	Maintenance	31
Auto Color Control Adjustment	17	Product Specifications	31
Manual Color Temperature Control	18	Your Zenith Limited Warranty	Back Cover
DRP (Digital Reality Picture)	18		
Picture Format Setup	18		
Sound Menu Options			
EZ Audio	19		
Equalizer Adjustments	19		
Sound Balance	19		
AVL (Auto Volume Leveler)	19		
Sound Selection in PC mode	20		

After reading this manual, keep it handy for future reference.

Introduction

L17W36 Controls & Connection Options

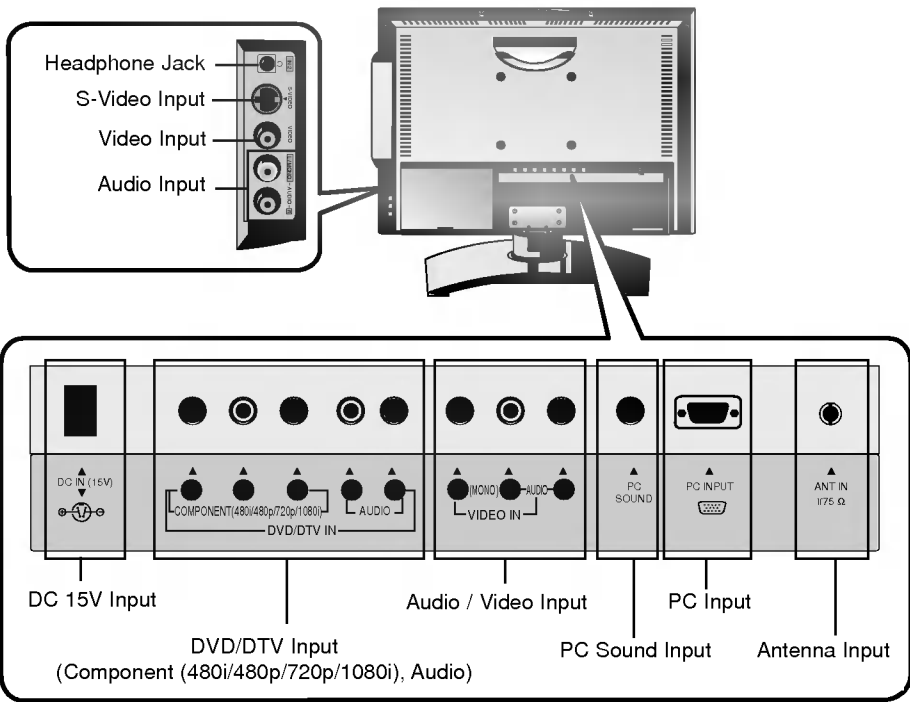
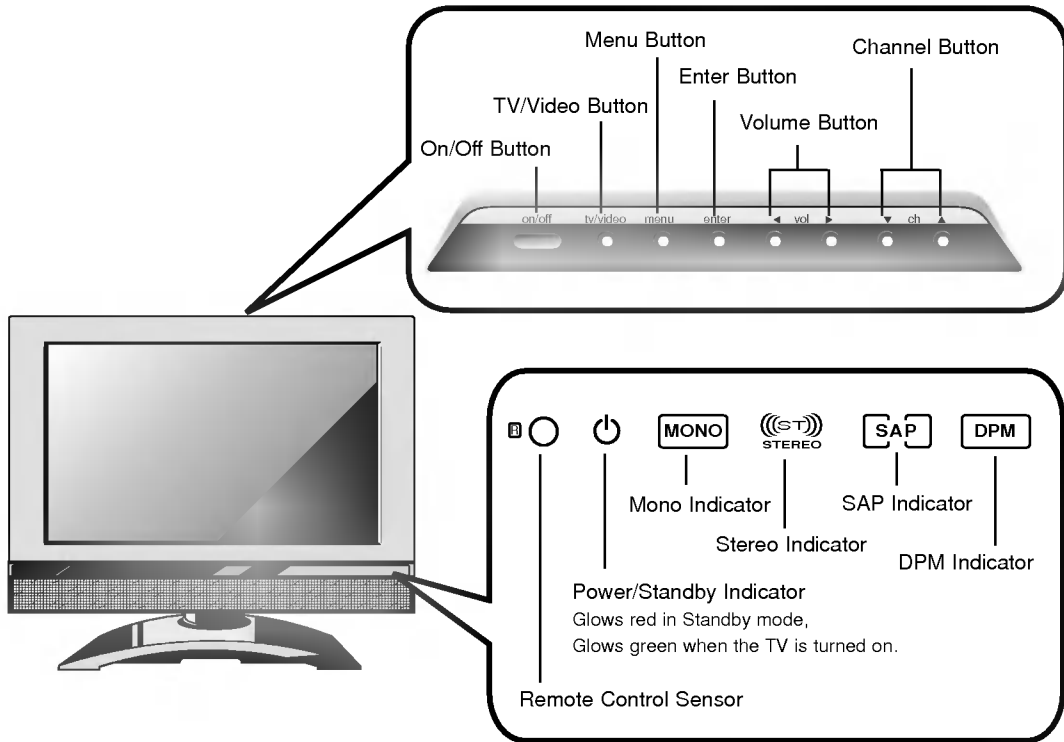

L23W36 Controls & Connection Options

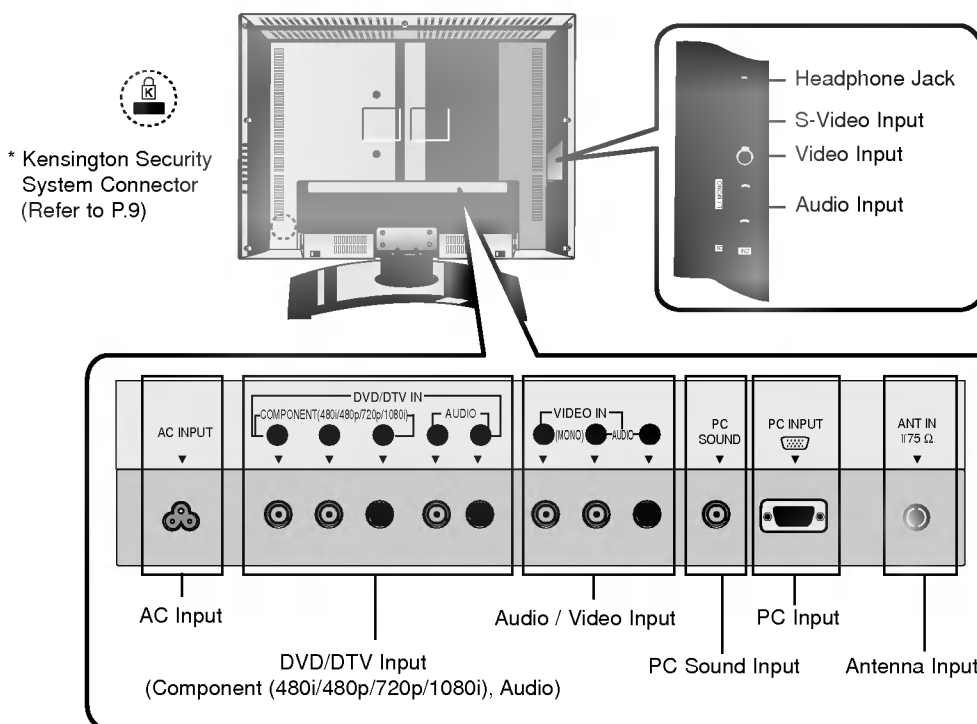
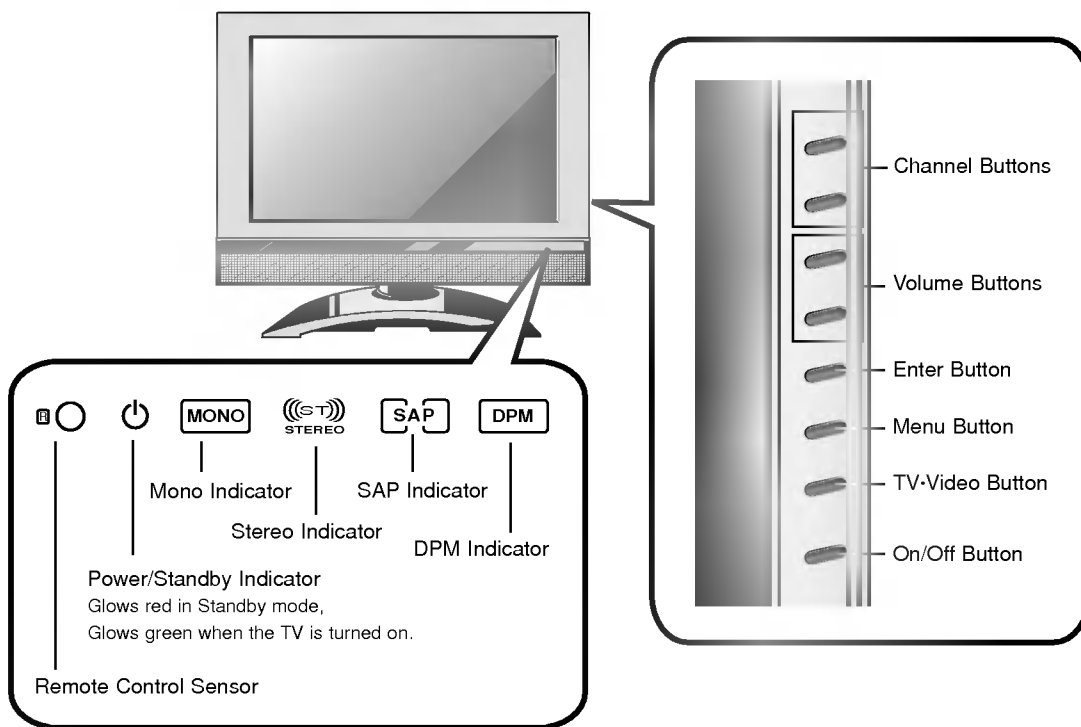

Remote Control Key Functions

- When using the remote control, aim it at the remote control sensor on the TV.

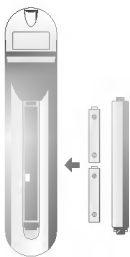
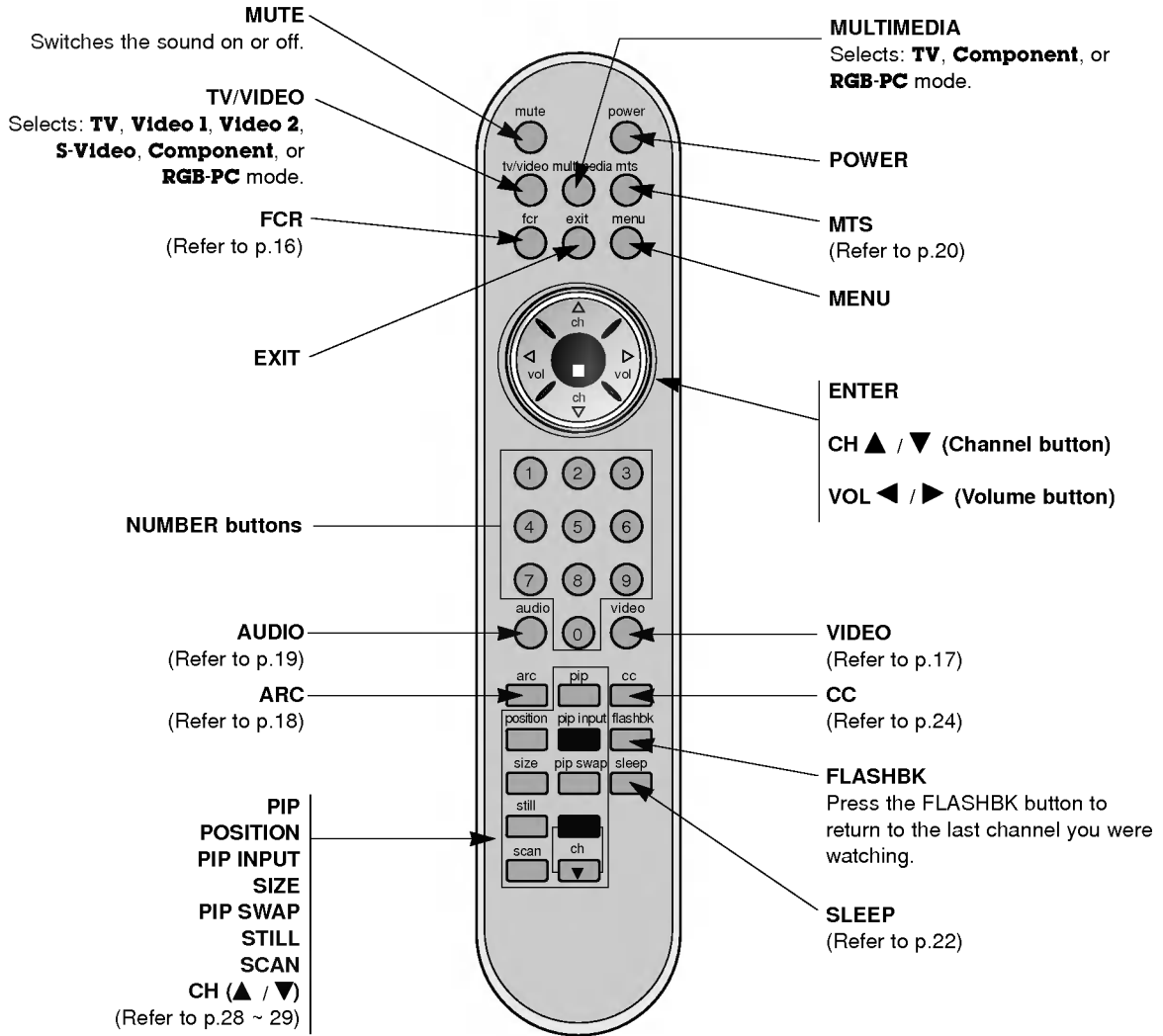

- Open the battery compartment cover on the back side and insert the batteries with correct polarity.
- Install two 1.5V batteries of AAA type. Don't mix used batteries with new batteries.

Installation

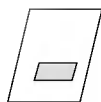

Operating Guide

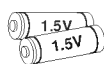

AAA Batteries

AC Adapter
(L17W36 Only)

Remote Control



PC Signal Cable



PC Sound Cable



Power Cord

Tie Bands
- Arrange the wires
with the tie bands.

Power Connections (L17W36 Only)

* Caution: Please make sure to connect the TV to the AC power adapter before connecting the TV's power plug to a wall power outlet.

- Remove the connection panel cover as shown below.
- Connect the antenna cable to the antenna input port on the TV.
- Connect the AC adapter to the power input port on the TV.
- Plug the power cord into the wall power outlet only after connecting the power cord to the AC adapter first.
- Reinstall the connection panel cover.

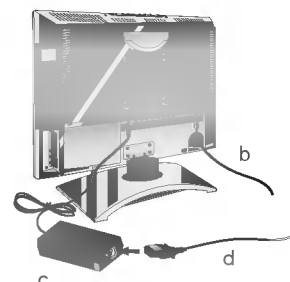
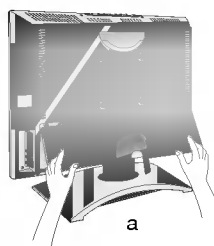

Kensington Security System (L23W36 Only)

- The TV is equipped with a Kensington Security System connector on the back panel. Connect the Kensington Security System cable as shown below.

- For the detailed installation and use of the Kensington Security System, refer to the user's guide provided with the Kensington Security System.

For further information, contact <http://www.kensington.com>, the internet homepage of the Kensington company. Kensington sells security systems for expensive electronic equipment such as notebook PCs and LCD projectors.

- Note: The Kensington Security System is an optional accessory.

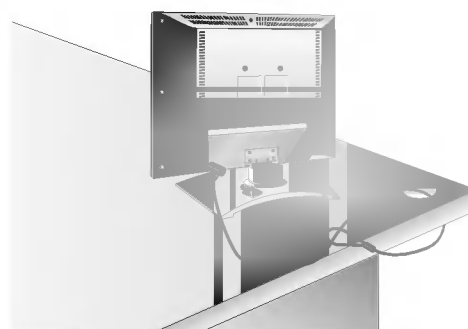

NOTES

- If the TV feels cold to the touch, there may be a small "flicker" when when it is turned on. This is normal, there is nothing wrong with TV.
- Some minute dot defects may be visible on the screen, appearing as tiny red, green, or blue spots. However, they have no adverse effect on the monitor's performance.
- Avoid touching the LCD screen or holding your finger(s) against it for long periods of time. Doing so may produce some temporary distortion effects on the screen.

Installation Instruction

* The connection panel is hidden behind the A/V cover.

- Remove the cover.
- Install wires as necessary.
- Reinstall the cover. Position the A/V cover with the TV back panel, tilt it back as shown.
- Align the holes on the TV back panel with the two tabs on the rear A/V cover and insert.
- Close cover.

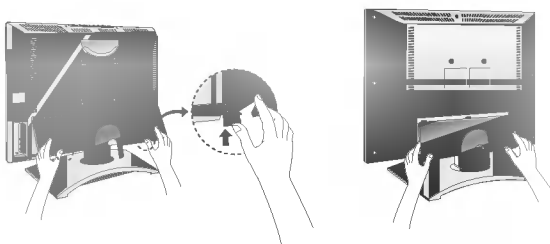

- Thread, then pull the wires through the hole on the TV stand.



Adjusting the TV Viewing Angle

- You can adjust the vertical angle of the TV between 3° and 12°.



- The TV can be conveniently swiveled on its stand 25° (L23W36) / 30° (L17W36) to the left or right to provide the optimum viewing angle.

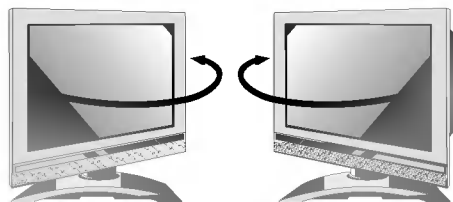

- An optional wall mount is available for this TV, see your dealer. For installation, follow the instructions provide with the optional wall mount.

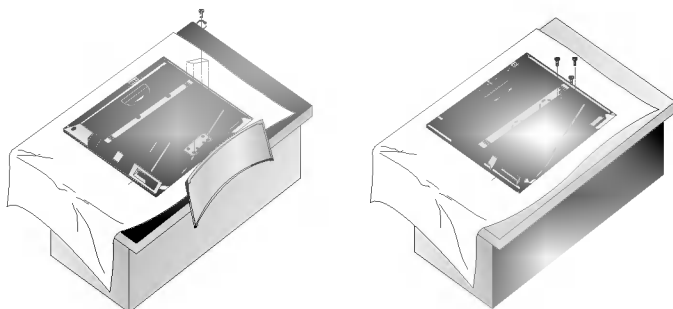

External Equipment Connections

- This manual mainly explains the features for the L17W36.

- For optimum picture quality, adjust antenna direction.

Connecting to an Inside Antenna Setup

- Typical wall antenna jack used in apartment buildings, connect the antenna cable as shown below. (Use the correct type of antenna cable for the type of wall antenna jack.)

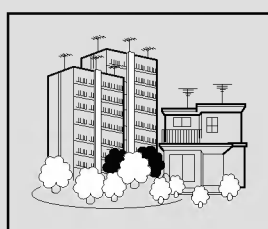

Apartment Buildings

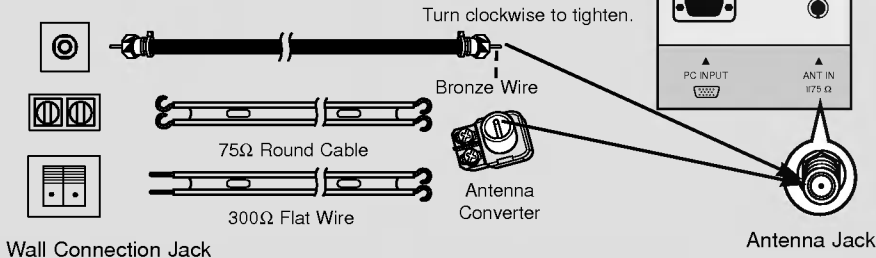

- If you have a 75Ω round cable, insert the bronze wire and then tighten the connection nut. If you have a 300Ω flat wire, connect the twisted wire to the antenna converter and then connect the converter to the antenna jack on the TV.
- If using 75Ω round cable, do not bend the bronze wire. It may cause poor picture quality.

Connecting to an Outdoor Antenna Setup

- This type of antenna is commonly used in single family dwellings.

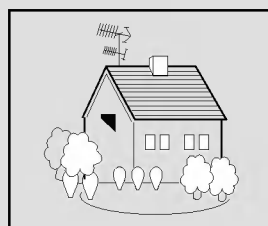

Single Family Home

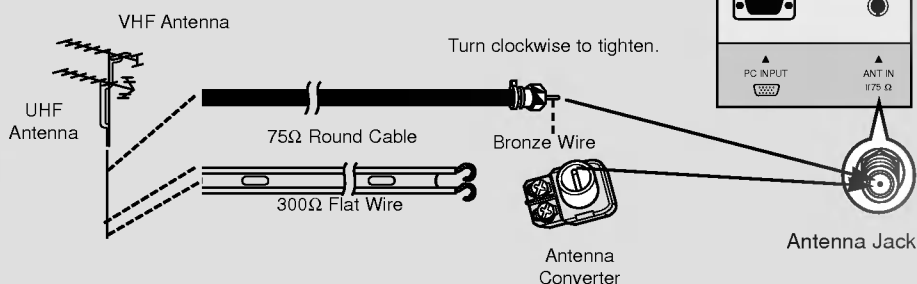

- In poor signal areas, to get better picture quality, install a signal amplifier to the antenna as shown to the right.
- If signal needs to be split for two TVs, use an antenna signal splitter for connection.

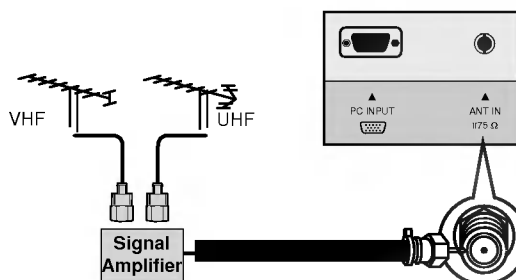

External Equipment Connections Continued

- In Video mode, TV automatically reverts to TV mode if the **fr** button or **flashbk** buttons are pressed.

Connection 1

Set VCR switch to 3 or 4 and then tune TV to the same channel number.

Connection 2

1. Connect the audio/video output jacks on VCR to the corresponding input jacks on the TV. When connecting the TV to a VCR, match the jack colors (Video = yellow, Audio Left = white, and Audio Right = red).
2. Insert a video tape into the VCR and press **PLAY** on the VCR. (Refer to the VCR owner's manual.)
3. Use the **tv/video** button on the remote control to select **Video 1** or **Video 2**. (If connected to S-VIDEO on side panel, select the **S-Video** external input source.)

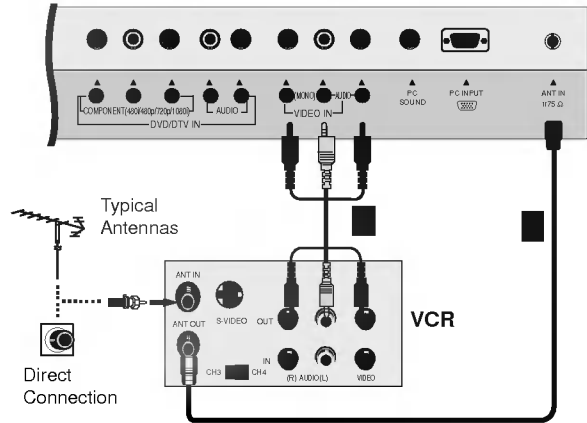

- After subscribing to a local cable TV service and installing a converter, you can watch cable TV programming.
 - For further cable TV information, contact a local cable service provider.

Connection 1

1. Select 3 or 4 with channel switch on cable box.
2. Tune the TV channel to the same selected output channel of cable box.
3. Select channels at the cable box or with the cable box remote control.

Connection 2

1. Connect the audio/video output jacks on Cable Box to the corresponding input jacks on the TV. When connecting the TV to Cable Box, match the jack colors (Video = yellow, Audio Left = white, and Audio Right = red).
2. Use the **tv/video** button on the remote control to select **Video 1** or **Video 2**.
3. Select channels with the cable box remote control.

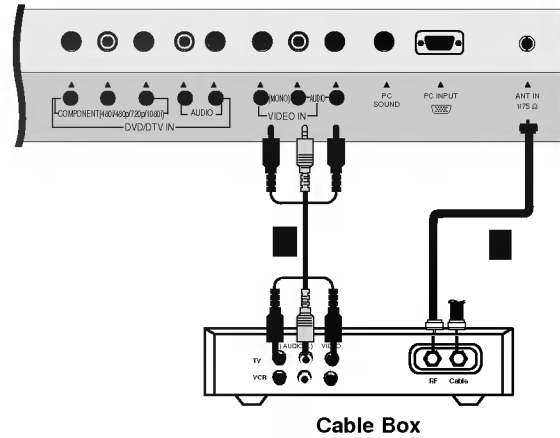

Connections

Connect the audio/video output jacks on the external A/V equipment to the corresponding input jacks on the TV. When connecting the TV to external A/V equipment, match the jack colors (Video = yellow, Audio Left = white, and Audio Right = red).

Viewing Setup

1. Turn on the external A/V equipment.
2. Use the **tv/video** button on the remote control to select **Video 1** or **Video 2**.
3. Operate the corresponding external equipment. Refer to external equipment operating guide.

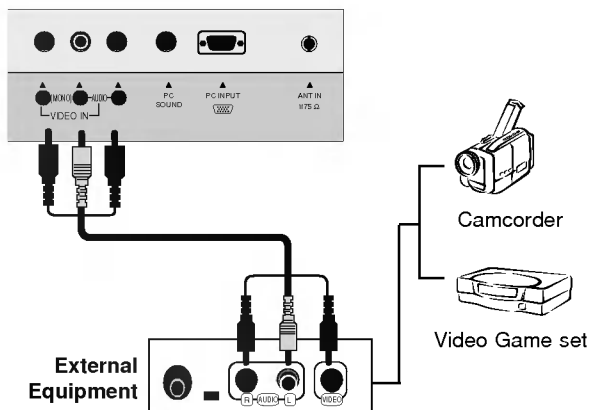

Connections

Connect the DVD video outputs to the COMPONENT (Y, PB, PR) jacks and connect the DVD audio outputs to the AUDIO jacks.

Viewing Setup

1. Turn on the DVD player, insert a DVD.
2. Use the **tv/video** or **multimedia** button on the remote control to select **Component**.
3. Refer to the DVD player's manual for operating instructions.

• Component Input ports

To get better picture quality, connect a DVD player to the component input ports as shown below.

Component ports of the TV	Y	
---------------------------	---	--

Video output ports of DVD player	Y	Pb
	Y	B-Y
	Y	Cb
	Y	PB

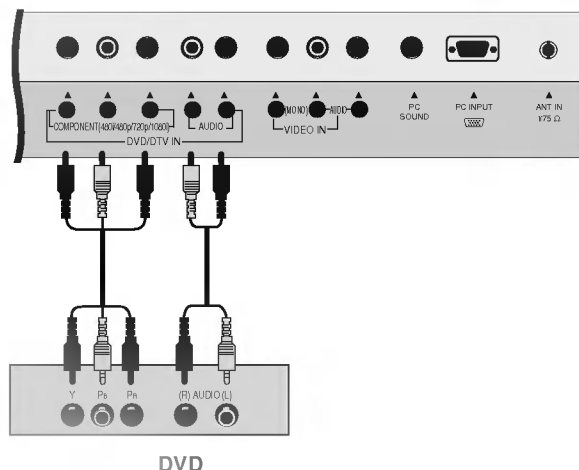

- To watch digitally broadcast programs, purchase and connect a digital set-top box.

Connections

Connect the digital set-top box video outputs to the COMPONENT (Y, PB, PR) jacks and connect the digital set-top box audio outputs to the AUDIO jacks.

Viewing Setup

1. Turn on the digital set-top box. (Refer to the owner's manual for the digital set-top box.)
2. Use the **tv/video** or **multimedia** button on the remote control to select **Component**.

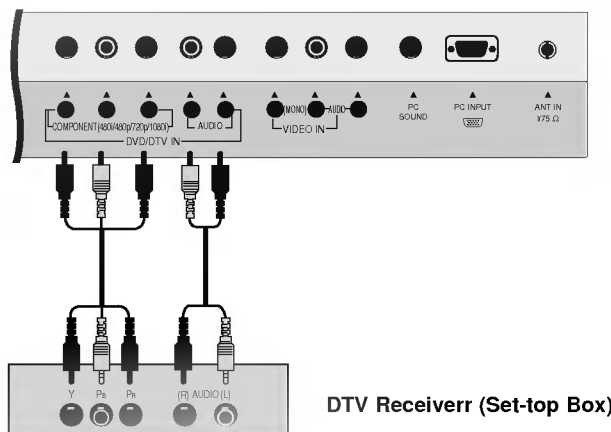

- Plug headphones in to H/P jack as shown.
- Adjust sound level to a headphone using the volume (◀, ▶) buttons. While you are listening to sound through a headphone(s), TV speakers will not be heard.

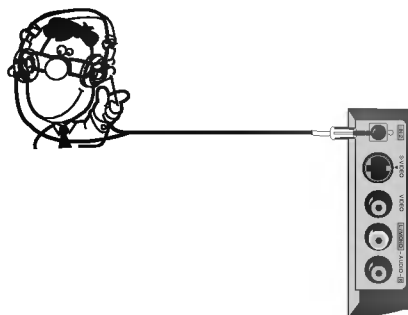



- After setup, be sure to select RGB-PC source on TV.

Connections

1. Set the monitor output resolution on the PC before connecting to the TV.
2. Connect the TV to the PC with the PC cable.
3. Connect the PC audio output to the TV's PC SOUND input.

Viewing Setup

1. Turn on the PC.
2. Use the **tv/video** or **multimedia** button on the remote control to select **RGB-PC**.

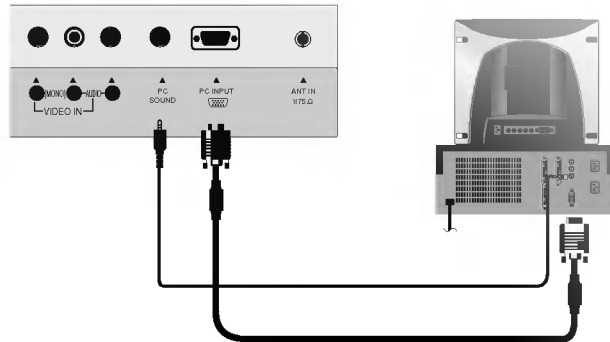

Monitor Display Specifications

Resolution	Horizontal Frequency(KHz)	Vertical Frequency(Hz)	Resolution	Horizontal Frequency(KHz)	Vertical Frequency(Hz)
640x480	31.4	60	832x624	49.7	75
	35	67	1024x768	48.3	60
	37.5	75		56.4	70
	43.2	85		60	75
800x600	35.1	56	1280x768	68.6	85
	37.8	60		39.5	50
	48	72	47.6	60	
	46.8	75			
	53.6	85			

NOTES

- a. For optimum picture quality, use standard XGA (1024x768) computer output at a 60Hz refresh rate. Using other formats (VGA, SVGA, etc.) or refresh rates may result in reduced picture quality. (To change the computer video output format, please refer to the operating manual for the computer you are using).
- b. If the message **“Out of range”** appears on the screen, adjust the PC output to a format listed in the ‘Displayable Monitor Output Format Specifications’ chart above.
- c. The synchronization input form for Horizontal and Vertical frequencies is separate.

DPM (Display Power Management) mode

If the PC goes to power saving mode, the monitor automatically switches to DPM mode. DPM mode may not work if you don't use the PC cable provided.

Operation

TV Operation Overview

1. First, make all equipment connections. Plug the AC Adapter into the TV, then plug the AC Adapter into a power outlet. At this time, the TV is switched to standby mode.
 - In standby mode, press the **power**, **ch** (▲, ▼), **tv/video**, **multimedia** or **number** button on the remote control or **on/off**, **ch** (▲, ▼), **tv/video** located on the TV to turn the TV on.
2. Select the viewing source by pressing **tv/video** or **multimedia** repeatedly.
 - Note: See page 16 if you have not auto programmed the TV to receive channels in your local broadcast area.
3. After viewing, press the **power** button on the remote control or **on/off** located on the TV. The TV reverts to standby mode.

NOTE

- If you want to turn the TV off, press the on/off button located on the TV. If you intend to be away on vacation, disconnect the power plug from the wall power outlet.

Menu Language Selection

- The menus can be shown on the screen in the selected language. First select your language.

1. Press the **menu** button and then use ▲ / ▼ button to select the **Special** menu.
2. Press the ► button and then use ▲ / ▼ button to select **Language**.
3. Use the ◀ / ▶ button to select your desired language.
From this point on, the on-screen menus will be shown in the language of your choice.
4. Press the **exit** button to save and return to TV viewing.

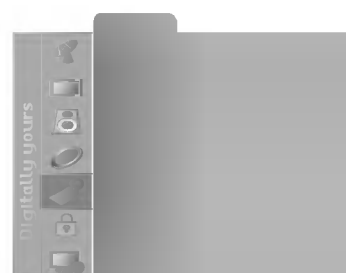

Channel Menu Options

Memorizing the Channels with EZ Scan

- For EZ scan to work, the programming source must be connected to the TV and the TV must be receiving programming signals either over-the-air or from a cable-type service provider.

1. Press the **menu** button and then use **▲ / ▼** button to select the **Channel** menu.
2. Press the **▶** button and then use **▲ / ▼** button to select **EZ Scan**.
3. Press the **▶** button to begin the channel search.

- Wait for auto program to complete the channel search cycle before choosing a channel. The TV scans for over-the-air channels and then channels provided by a cable service.



NOTES

- When the channel search is complete, use the **▲ / ▼** buttons to review the memorized channels.
- If you press the **enter** button in EZ Scanning, the function will stop and only channels programming up to that time will remain.
- EZ Scan function can memorize only the channels which are being received at that time.

- You can manually include or erase individual channels.

1. Press the **menu** button and then use **▲ / ▼** button to select the **Channel** menu.
2. Press the **▶** button and then use **▲ / ▼** button to select **Ch.edit**.
3. Press the **▶** button and then use **◀ / ▶** button to select a channel you want to add to memory or erase.
4. Press the **▼** button and then use **◀ / ▶** button to select **Memory** (add) or **Erase** (delete).
6. Press the **exit** button to save and return to TV viewing. The current channel is added to Memory or Erased from the channel list.

The current channel number is displayed.



- This function adjusts the pictures stability and condition when it is poor.

1. Press the **menu** button and then use **▲ / ▼** button to select the **Channel** menu.
2. Press the **▶** button and then use **▲ / ▼** button to select **Ch.edit**.
3. Press the **▶** button and then use **▲ / ▼** button to select **Fine**.
4. Use the **◀ / ▶** button to adjust the picture to your preference.
5. Press the **exit** button to save and return to TV viewing.



- Favorite Channel lets you quickly tune in up to 5 channels of your choice without having to wait for the TV to scan through all the in-between channels.

1. Press the **menu** button and then use **▲ / ▼** button to select the **Channel** menu.
2. Press the **▶** button and then use **▲ / ▼** button to select **Favorite ch..**
3. Press the **▶** button and then use **▲ / ▼** button to select the first favorite channel position.
4. Use the **◀ / ▶** button to set the desired channel number for first favorite channel.
5. Repeat steps 3 to 4 to memorize other channels.
6. Press the **enter** button to save.

- To tune to a favorite channel, press the **fcn** (Favorite Channel Review) button repeatedly. The 5 favorite channels appear on the screen one-by-one.

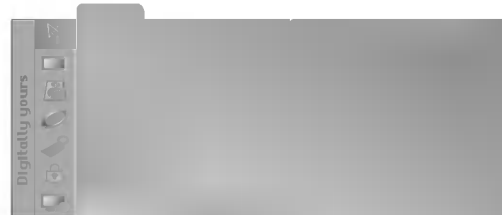

Picture Menu Options

- This function adjusts the TV for the best picture appearance.

1. Press the **video** button repeatedly to select the picture appearance setup option as shown below.

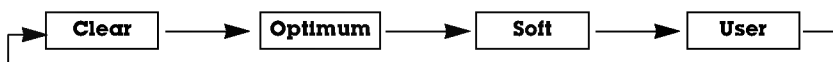

- You can also adjust **EZ Video** in the **Picture** menu.
- **Clear**, **Optimum** and **Soft** are preset for good picture quality at the factory and cannot be changed.

- You can adjust picture contrast, brightness, color, sharpness and tint to the levels you prefer.

1. Press the **menu** button and then use **▲ / ▼** button to select the **Picture** menu.
2. Press the **▶** button and then use **▲ / ▼** button to select **EZ Video**
3. Press the **enter** button and then use **▲ / ▼** button to select the desired picture option (**Contrast**, **Brightness**, **Color**, **Sharpness**, **Tint**).
4. Use the **◀ / ▶** button to make appropriate adjustments.
 - Contrast, Brightness, Color, and Sharpness are adjustable from 0 to 100.
 - Tint is adjustable from Red 50 to Green 50.
5. Press the **exit** button to save and return to TV viewing.



- To initialize values (reset to default settings), select the **Normal** option.

1. Press the **menu** button and then use **▲ / ▼** button to select the **Picture** menu.
2. Press the **▶** button and then use **▲ / ▼** button to select **ACC**.
3. Use the **◀ / ▶** button to select either **Normal** (Default), **Warm** (Preset), **User** (Manual Adjustment) or **Cool** (Preset).
4. Press the **exit** button to save and return to TV viewing.



Picture Menu Options Continued

Manual Color Temperature Control (User option)

- You can adjust red, green, or blue to any color temperature you prefer.
1. Press the **menu** button and then use ▲ / ▼ button to select the **Picture** menu.
 2. Press the ► button and then use ▲ / ▼ button to select **ACC**.
 3. Press the **enter** button and then use ▲ / ▼ button to select **Red**, **Green** or **Blue**.
 4. Use the ◀ / ▶ button to make appropriate adjustments.
 - The adjustment range of **Red**, **Green**, and **Blue** is 0 ~100.
 5. Press the **exit** button to save and return to TV viewing.



DRP (Digital Reality picture)

- Improves picture outline in dark areas.
1. Press the **menu** button and then use ▲ / ▼ button to select the **Picture** menu.
 2. Press the ► button and then use ▲ / ▼ button to select **DRP**.
 3. Use the ◀ / ▶ button to select **Clear** or **Soft**.
 4. Press the **exit** button to save and return to TV viewing.

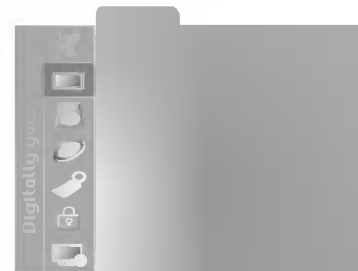

1. Press the **arc** button repeatedly to select the desired picture format.



- Picture format Zoom is not available in Component and RGB-PC mode.

Sound Menu Options



- This function lets you enjoy the best sound without any special adjustment because the TV selects the appropriate sound option based on the program content.

1. Use the **audio** button to select the appropriate sound setup as shown below.

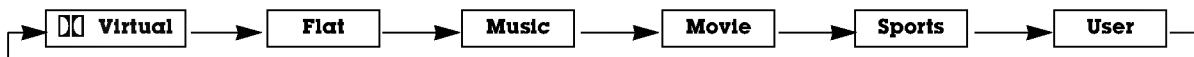

- You can also adjust **EZ Audio** in the **Sound** menu.
- Manufactured under license from Dolby Laboratories. “Dolby” and the double-D symbol are trademarks of Dolby Laboratories.
- Virtual lets you experience panoramic sound effects.



1. Press the **menu** button and then use **▲ / ▼** button to select the **Sound** menu.
2. Press the **▶** button and then use **▲ / ▼** button to select **EZ Audio**.
3. Press the **enter** button and then use **◀ / ▶** button to select the band you want to adjust. Then, use **▲ / ▼** button to adjust the band level.
5. Press the **exit** button to save and return to TV viewing.



1. Press the **menu** button and then use **▲ / ▼** button to select the **Sound** menu.
2. Press the **▶** button and then use **▲ / ▼** button to select **Balance**.
3. Use the **◀ / ▶** button to adjust the sound balance.
 - Balance is adjustable from Left 50 to Right 50.
4. Press the **exit** button to save and return to TV viewing.



- AVL maintains an equal volume level automatically even if the channel is changed.

1. Press the **menu** button and then use **▲ / ▼** button to select the **Sound** menu.
2. Press the **▶** button and then use **▲ / ▼** button to select **AVL**.
3. Use the **◀ / ▶** button to select **On** or **Off**.
4. Press the **exit** button to save and return to TV viewing.

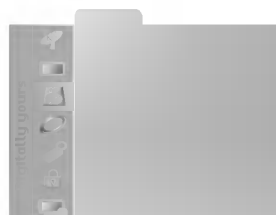

Sound Menu Options Continued

- Be sure to select the RGB-PC source and turn on the PIP before operation.

1. Press the **menu** button and then use **▲ / ▼** button to select the **Sound** menu.
2. Press the **▶** button and then use **▲ / ▼** button to choose **Sound select**.
3. Use the **◀ / ▶** button to select desired screen sound (**RGB-PC** or **PIP**).
4. Press the **exit** button to save and return to TV viewing.



Stereo/SAP Broadcasts Setup

- The TV can receive MTS stereo programs and any SAP (Secondary Audio Program) that accompanies the stereo program, if the broadcaster transmits an additional sound signal as well as the original one.
- Mono: The primary language is heard from left and right speakers. Signal mode is mono.
- Stereo: The primary language is heard from left and right speakers. Signal mode is stereo.
- SAP: The secondary language is heard from left and right speakers.

1. Press the **mts** button repeatedly.



- Select mono sound mode if the signal is not clear or in poor signal reception areas.
- **Stereo, SAP** mode are available only if included on the broadcast signal.

Time Menu Options

- The time is set automatically through from a PBS broadcast signal.
- The PBS channel signal includes information for the correct time and daylight saving time.

1. Press the **menu** button and then use **▲ / ▼** button to select the **Timer** menu.
2. Press the **▶** button and then use **▲ / ▼** button to select **Clock**.
3. Press the **▶** button and then use **▲ / ▼** button to select **Auto**.
4. Press the **▶** button and then use **▲ / ▼** button to select the time zone for your viewing area. Your choices are: **Auto**, **E.S.T.** (Eastern Standard Time), **C.S.T.** (Central Standard Time), **M.S.T.** (Mountain Standard Time), **P.S.T.** (Pacific Standard Time), **Alaska**, and **Hawaii**.
5. Press the **▶** button and then use **▲ / ▼** button to set **PBS channel**.
6. Press the **▶** button and then use **▲ / ▼** button to set **D.S.T.** (Daylight Savings Time) **Auto**, **Off** or **On**, depending on whether or not your viewing area observes Daylight Savings Time.
7. Press the **exit** button to save and return to TV viewing.



- If the time on the clock is incorrect, reset the clock manually.

1. Press the **menu** button and then use **▲ / ▼** button to select the **Timer** menu.
2. Press the **▶** button and then use **▲ / ▼** button to select **Clock**.
3. Press the **▶** button and then use **▲ / ▼** button to select **Manual**.
4. Press the **▶** button and then use **▲ / ▼** button to set the hour.
5. Press the **▶** button and then use **▲ / ▼** button to set the minutes.
6. Press the **exit** button to save and return to TV viewing.



Time Menu Options Continued

- Timer function operates only if current time is set.
- Off-Timer function overrides On-Timer function if they are set to the same time.
- The TV must be in standby mode for the On-Timer to work.
- If you don't press any button within 2 hours after turning on the TV with the On-Timer function, the TV will automatically revert to standby mode.

1. Press the **menu** button and then use ▲ / ▼ button to select the **Timer** menu.

2. Press the ► button and then use ▲ / ▼ button to select **Off timer** or **On timer**.

3. Press the ► button and then use ▲ / ▼ button to set the hour.

4. Press the ► button and then use ▲ / ▼ button to set the minutes.

5. For On timer function only:

Press the ► button and then use ▲ / ▼ button to set the channel at turn-on.

Then, press the ► button and then use ▲ / ▼ button to set the turn-on sound level.

6. Press the ► button and then use ▲ / ▼ button to select **Run** or **Hold**.

• **Hold:** **Off timer/On timer** will not work.

Run: **Off timer/On timer** are active.

7. Press the **exit** button to save and return to TV viewing.



- The Sleep Timer turns the TV off at a preset time.

1. Press the **sleep** button repeatedly to select the number of minutes. First the  option appears on the screen, followed by the following sleep timer options: 10, 20, 30, 60, 90, 120, 180, and 240 minutes.

2. When the number of minutes you want is displayed on the screen, press the **enter** button. The timer begins to count down from the number of minutes selected.

3. To check the remaining minutes before the TV turns off, press the **sleep** button once.

4. To cancel the Sleep Timer, press the **sleep** button repeatedly until  appears.

Special Menu Options

Closed Captions

Closed captioning is a process which converts the audio portion of a television program into written words which then appear as subtitles on the television screen. Closed captions allow viewers to read the dialogue and narration of television programs.

Using Closed Captions

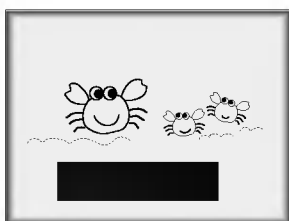

Captions are the subtitles of the dialogue and narration of television programs. For prerecorded programs, program dialogue can be arranged into captions in advance. It's possible to caption a live program by using a process called real-time captioning, which creates captions instantly. Real-time captioning is normally done by professional reporters using a machine shorthand system and computer for translation into English. Captioning is an effective system for the hearing-impaired, and it can also aid in teaching language skills.

- The picture at left shows a typical caption.

Caption Tips

- Not all TV broadcasts include closed caption signals.
- Sometimes TV stations broadcast four different caption signals on the same channel. By selecting **From CC 1 to CC 4**, you can choose which signal you view. **CC 1** is usually the signal with the captions, while **Another mode** might show demonstration or programming information.
- Your TV might not receive caption signals normally in the following situations.

1. Poor reception conditions are encountered:



- **IGNITION:**
Picture may flutter, drift, suffer from black spots, or horizontal streaking. Usually caused by interference from automobile ignition systems, neon lamps, electrical drills, and other electrical appliances.



- **GHOSTS:**
Ghosts are caused when the TV signal splits and follows two paths. One is the direct path and the other is reflected off tall buildings, hills or other objects. Changing the direction or position of the antenna may improve reception.



- **SNOW:**
If your receiver is located at the weak, fringe area of a TV signal, your picture may be marred by small dots. It may be necessary to install a special antenna to improve the picture.

2. An old, bad, or illegally recorded tape is being played.
3. Strong, random signals from a car or airplane interfere with the TV signal.
4. The signal from the antenna is weak.
5. The program wasn't captioned when it was produced, transmitted, or taped.

Special Menu Options Continued

1. Use the **cc** button repeatedly to select Captions.

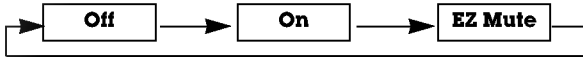

- You can also adjust **Captions** in the **Special** menu.
- **Ez Mute** shows the selected captions option (if available on program) when the TV sound is muted.
- It's not available in Component and RGB-PC modes.

1. Press the **menu** button and then use **▲ / ▼** button to select the **Special** menu.
2. Press the **▶** button and then use **▲ / ▼** button to select **Caption/Text**.
3. Use the **◀ / ▶** button to select your caption selection. Your choices are: **CC1, CC2, CC3, CC4, Text 1, Text 2, Text3** and **Text4**.
4. Press the **exit** button to save and return to TV viewing.

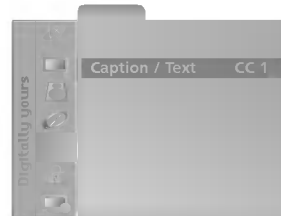

- The TV can be set up so that it can only be used with the remote control.
- This feature can prevent unauthorized viewing.

1. Press the **menu** button and then use **▲ / ▼** button to select the **Special** menu.
2. Press the **▶** button and then use **▲ / ▼** button to select **Key lock**.
3. Use the **◀ / ▶** button to select **On** or **Off**.
4. Press the **exit** button to save and return to TV viewing.

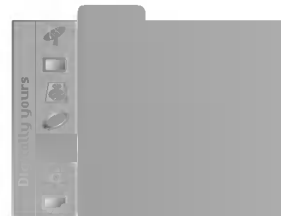

- If Auto Off is active and there is no input signal, the TV switches to Standby mode automatically after 10 minutes.

1. Press the **menu** button and then use **▲ / ▼** button to select the **Special** menu.
2. Press the **▶** button and then use **▲ / ▼** button to select **Auto off**.
3. Use the **◀ / ▶** button to select **On** or **Off**.
4. Press the **exit** button to save and return to TV viewing.

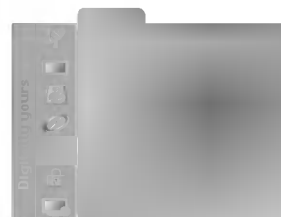

Lock Menu Options

Parental Control can be used to block specific channels, ratings and other viewing sources.

The Parental Control Function (V-Chip) is used to block program viewing based on the ratings sent by the broadcast station. The default setting is to allow all programs to be viewed. Viewing can be blocked by the type of program and by the categories chosen to be blocked. It is also possible to block all program viewing for a time period. To use this function, the following must be set :

1. Ratings and categories to be blocked.
2. Set a password
3. Enable the lock

V-Chip rating and categories

Rating guidelines are provided by broadcast stations. Most television programs and television movies can be blocked by TV Rating and/or Individual Categories. Movies that have been shown at the theaters or direct-to-video movies use the Movie Rating System (MPAA) only.

For Movies previously shown in theaters :

Movie Ratings :

- Unblocked
- G and Above (general audience)
- PG and Above (parental guidance suggested)
- PG-13 and Above (13 years and older)
- R and above (restricted)
- NC-17 and Above (18 years and older)
- X (adult)

If you set PG-13 and Above : G and PG movies will be available , PG-13, R, NC-17 and X will be blocked.

For Television programs including made-for-TV movies:

General TV Ratings:

- Unblocked
- TV-G and Above (general audience) (individual categories do not apply)
- TV-PG and Above (parental guidance suggested)
- TV-14 and Above (14 years and older)
- TV-MA (mature audience)

Children TV Ratings:

- Unblocked
- TV-Y and Above (youth) (individual content categories do not apply)
- TV-Y7 (youth, 7 years and up)

Content Categories:

- Dialog - sexual dialogue (applies to TV-PG and Above, TV-14)
- Language - adult language (applies to TV-PG and Above, TV-14 and Above, TV-MA)
- Sex scenes - sexual situations (applies to TV-PG and Above, TV-14 and Above, TV-MA)
- Violence (applies to TV-PG and Above, TV-14 and Above, TV-MA)
- F Violence - fantasy violence (applies only to TV-Y7)
- No Rating (blocks all viewing)

For Canadian English/French language rating system:

Canadian English language rating system:

- C and Above (Children)
- C8+ and Above (8 years and older)
- G and Above (General programming. Suitable for all audiences.)
- PG and Above (Parental guidance suggested)
- 14+ and Above (Viewer 14 years and older)
- 18+ (Adult programming)

Canadian French language rating system:

- G and Above (General)
- 8 ans+ and Above (8 years and older)
- 13 ans+ and Above (13 years and older)
- 16 ans+ and Above (16 years and older)
- 18 ans+ (Adults only)

Lock Menu Options Continued

1. Press the **menu** button and then use ▲ / ▼ button to select the **Lock** menu.
Then, press the ► button.
 - If **Lock** is already set, enter the password requested.
 - The TV is set with the initial password "0-0-0-0".
2. **Setting Lock on/off:**
Press the ▲ / ▼ button to select **Lock on/off**.
Use the ◀ / ▶ button to select **on** or **off**.
3. **Set password:**
Press the ▲ / ▼ button to select **Set password**.
Press the ► button and then enter a four digit password.
Enter it again when requested.
4. Press the ▲ / ▼ button to select type of blocking to be set .
5. Press the ► button and then use ▲ / ▼ button to select type of ratings to block .
 - **Age block**, **Content block**, and **Canadian** menus, also have sub menus. So, repeat steps 4 and 5 in the sub menu, to set the types of blocking and ratings.



RGB-PC Menu Options

- Be sure to select the RGB-PC source before operation.

- Automatically adjusts picture position and minimizes image shaking.
- If the image is still not correct, your TV is functioning properly but needs further adjustment.

1. Press the **menu** button and then use ▲ / ▼ button to select the **RGB-PC** menu.
2. Press the ► button and then use ▲ / ▼ button to select **Auto configure**.
3. Press the ► button to run Auto configure.
 - If the position of the image is still not correct, try Auto adjustment again.
4. If picture needs to be adjusted more after Auto adjustment in RGB-PC mode, you can adjust the **Clock / Phase**.



Horizontal / Vertical Position Adjustments

1. Press the **menu** button and then use ▲ / ▼ button to select the **RGB-PC** menu.
2. Press the ► button and then use ▲ / ▼ button to select **H-Position / V-Position**.
3. Press the ◀ / ▶ button to make adjustments.
 - The adjustment range is 0 ~ 100.
4. Press the **exit** button to save and return to TV viewing.



- If the picture isn't clear after auto adjustment and especially if characters are still jittery, adjust the picture Phase manually.

1. Press the **menu** button and then use ▲ / ▼ button to select the **RGB-PC** menu.
2. Press the ► button and then use ▲ / ▼ button to select **Clock or Phase**.
4. Use the ◀ / ▶ button to make appropriate adjustments.
 - The **Clock** adjustment range is 0 ~ 100.
 - The **Phase** adjustment range is 0 ~ 31.
 - Based on the input mode, the adjustment range for **Clock / Phase** may change.
4. Press the **exit** button to save and return to TV viewing.

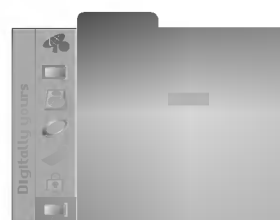

PIP (Picture-in-Picture) Feature

- PIP lets you view 2 different inputs pictures (sources) on your TV screen at the same time. One source will be large, and the other source will show a smaller inset image.
- Double Window splits the screen into 2, allowing 2 picture sources to be shown on the TV screen at the same time. Each source is given half the screen.
- PIP is not available if **Lock** is active (**On**) in **Lock** menu.

Press the **pip** button repeatedly to select one of the PIP options.

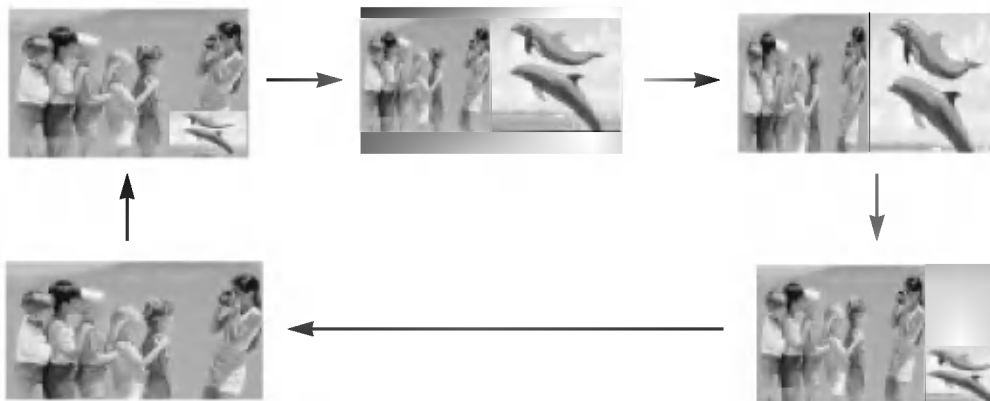

* You can only select this Double Window using RGB-PC for main picture source. With this setup, the main and sub pictures cannot be swapped.

Use the **ch ▲ / ch ▼** button to select a channel for the sub picture in PIP mode.

1. Press the **still** button in PIP mode.

- In PIP mode, the PIP (inset) picture's image is frozen.

2. To return to normal viewing, press the **still** button again.

Press the **size** button and then use **◀ / ▶** button to change the sub picture size.



Press the **position** button in PIP mode.

Press the **▲ / ▼ / ◀ / ▶** button repeatedly until desired position is achieved. The sub picture moves up/down/left/right.

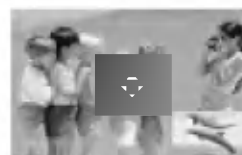



Press the **pip swap** button to switch the main and sub pictures.

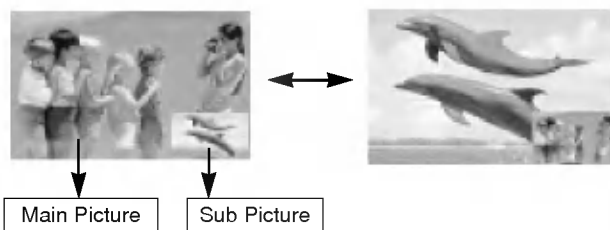

Selecting an Input Signal Source for PIP

Use the **pip input** button to select the input source for the sub picture. Each press of **pip input** button changes the PIP source.

Main Picture Source	Available Sub Picture Sources
TV, Video 1, Video 2, and S-Video	Component, and RGB-PC
Component, and RGB-PC	TV, Video 1, Video 2, and S-Video



- Use POP to search the programs of all the memorized channels one-by-one, while the main picture source remains the current channel.
- Press the **scan** button in PIP mode. Each press of **scan** button changes the screen as shown below.
- Note: Run EZ Scan channel search before using POP mode.

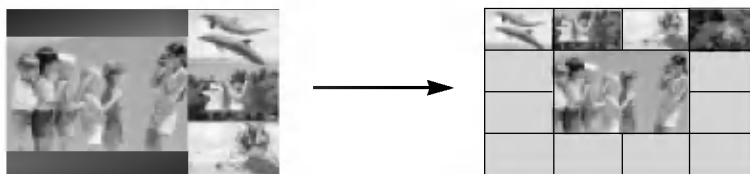

* In Component mode, this POP mode only operates.

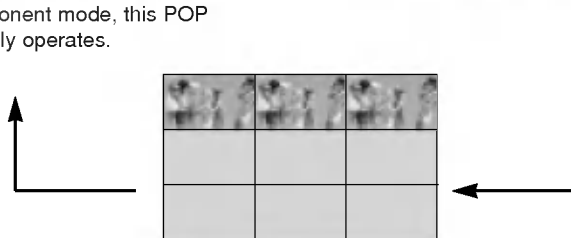

Troubleshooting Checklist

SYMPTOMS

No power

No picture or sound

Poor picture but good sound

Poor reception

Lines in picture

Ghosts (multiple images)

Remote control does not work.

Cannot tune desired channel.

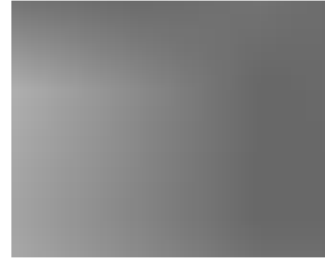

CHECK THESE THINGS

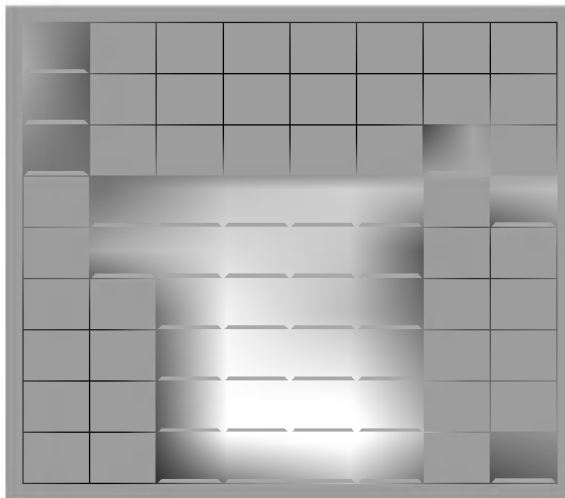

- Is power cord plugged in ?
- Is television turned on ?
- Check batteries in remote control.
- Try another channel (station trouble).
- Check antenna connectings.
- Check for local interference.
- Adjust the antenna.
- Adjust the picture control.
- Program channel using EZ Scan.

Maintenance

- Early malfunctions can be prevented. Careful and regular cleaning can extend the amount of time you will have your new TV. Be sure to turn the power off and unplug the power cord before you begin any cleaning.

1. Here's a great way to keep the dust off your screen for a while. Wet a soft cloth in a mixture of lukewarm water and a little fabric softener or dish washing detergent. Wring the cloth until it's almost dry, and then use it to wipe the screen.
2. Make sure the excess water is off the screen, and then let it air-dry before you turn on your TV.

To remove dirt or dust, wipe the cabinet with a soft, dry, lint-free cloth. Please be sure not to use a wet cloth.



If you leave your TV dormant for a long time (such as a vacation), it's a good idea to unplug the power cord to protect against possible damage from lightning or power surges.

Product Specifications

Power Requirement	DC15V/4.5A	AC100-240V ~ 60Hz
Television System	NTSC	
Television Channel	VHF : 2 ~ 13, UHF : 14 ~ 69, Cable : 01 ~ 125	
Television Screen	LCD Panel	
Power Consumption	See the back of the set	
External Antenna Impedance	75 Ω	
Audio Output	5 W + 5 W	7 W + 7 W
Adapter (DC Power)	In: AC 100-240V ~ 1.6A-0.7A, 50/60Hz Out: DC 15V, 4.5A * For use only with Model No. SAD7015SE AC Adapter, manufactured by H & E CO., LTD.	

**ZENITH ELECTRONICS CORPORATION
LCD-TV L17W36, L23W36 LIMITED WARRANTY – USA**



Zenith will repair or replace your product, at Zenith's option, if it proves to be defective in material or workmanship under normal use, during the warranty period ("Warranty Period") listed below, effective from the date ("Date of Purchase") of original purchase of the product. This limited warranty is good only to the original purchaser of the product and effective only when used in the United States, excluding U.S. Territories.

<p><u>WARRANTY PERIOD:</u></p> <p>LABOR: 1 Year from the Date of Purchase.</p> <p>PARTS: 1 Year from the Date of Purchase.</p> <p>* Repaired or replaced products are warranted for the remaining portion of the original warranty period.</p>	<p><u>HOW SERVICE IS HANDLED:</u></p> <p>Factory Service. Call 1-877-9Zenith (1-877-993-6484) (24 hours a day, 365 days per year) for instructions on getting the defective unit repaired or replaced.</p> <p>Please retain dated sales receipt and your box to return the unit to Zenith for replacement.</p> <p>Shipping charges both ways will be paid by Zenith during the Warranty Period.</p> <p>Visit our website at http://www.zenithservice.com</p>
---	--

THIS WARRANTY IS IN LIEU OF ANY OTHER WARRANTIES, EXPRESS OR IMPLIED, INCLUDING WITHOUT LIMITATION, ANY WARRANTY OF MERCHANTABILITY OR FITNESS FOR A PARTICULAR PURPOSE. TO THE EXTENT ANY IMPLIED WARRANTY IS REQUIRED BY LAW, IT IS LIMITED IN DURATION TO THE EXPRESS WARRANTY PERIOD ABOVE. ZENITH WILL NOT BE LIABLE FOR ANY INCIDENTAL, CONSEQUENTIAL, INDIRECT, SPECIAL, OR PUNITIVE DAMAGES OF ANY NATURE, EVEN IF ADVISED OF THE POSSIBILITY OF SUCH DAMAGES, INCLUDING WITHOUT LIMITATION, LOST REVENUES OR PROFITS, LOST OR CORRUPTED PROGRAMMING OR DATA, OR ANY OTHER DAMAGE WHETHER BASED IN CONTRACT, TORT, OR OTHERWISE.

Some states do not allow the exclusion or limitation of incidental or consequential damages or limitations on how long an implied warranty lasts, so the above exclusion or limitation may not apply to you. This warranty gives you specific legal rights and you may also have other rights that vary from state to state.

THIS LIMITED WARRANTY DOES NOT APPLY TO:

- Damages or operating problems that result from shipping, installation, adjustment of user controls, calibration, maintenance or failure to maintain, or separate system components; and
- Damages or operating problems that result from normal wear and tear, misuse, abuse, operation outside environmental specifications or contrary to the requirements or precautions in the Operating Guide, accident, lightning strikes or other natural causes, unauthorized modification or alteration, incorrect electrical current or voltage, signal reception or input, operating and software protocols adopted after date of manufacture or for outside the US, institutional or commercial use, or other causes not arising out of defect in material or workmanship.

The cost of repair or replacement under these excluded circumstances shall be borne by the consumer.

CUSTOMER INTERACTIVE CENTER NUMBERS:

<p>For Where to buy, Product Assistance, or Customer Assistance</p>	<p>Call 1-877-9Zenith (1-877-993-6484) (24 hours a day, 365 days per year) and select appropriate options from the menu.</p> <p>Or visit our website at http://www.zenithservice.com</p>
--	---

LG Customer Interactive Center
201 James Record Road
Huntsville, Alabama 35824
<http://www.zenithservice.com>

P/N : 3828VA0387C (f)(ML027C)