



MODEL: GR-322SBF

REFRIGERATOR OPERATION MANUAL

Please read the manual carefully before using the refrigerator. After reading the manual, please keep it for reference when necessary.

样品
04.05.07

CONTENT

NAME OF PARTS	2
MOVEMENT & TRANSPORTATION.....	3
EARTH CONNECTION.....	3
INSTALLATION.....	4
PLEASE FAMILIARISE WITH THE FOLLOWING PARTS.....	5
FUNCTION OPERATING AND DISPLAY.....	6
METHODS OF MAKING ICE.....	7
WAYS TO DISASSEMBLE SPARE PARTS.....	8
BEST WAYS TO STORE FOOD.....	10
DOOR COOLING FUNCTION.....	11
DEODORISATION.....	11
FRUIT & VEGETABLE COMPARTMENT.....	11
CLEANING THE REFRIGERATOR	12
SAFETY GUARDS.....	13
DOES THE REFRIGERATOR HAVE A MALFUNCTION.....	15
THIS IS NOT A MALFUNCTION.....	16
APPENDIX.....	17

NAME OF PARTS

Refrigerator
Compartment

Refrigerator Shelf

Refrigerator Lamp

Fruit & Vegetable
Compartment Cover

Fruit & Vegetable
Compartment

Active Deodorizer

Freezing
Compartment

Freezing
Compartment Drawer

Adjustable Foot

Multi-Functional
Rack

Can Rack

Bottle Rack

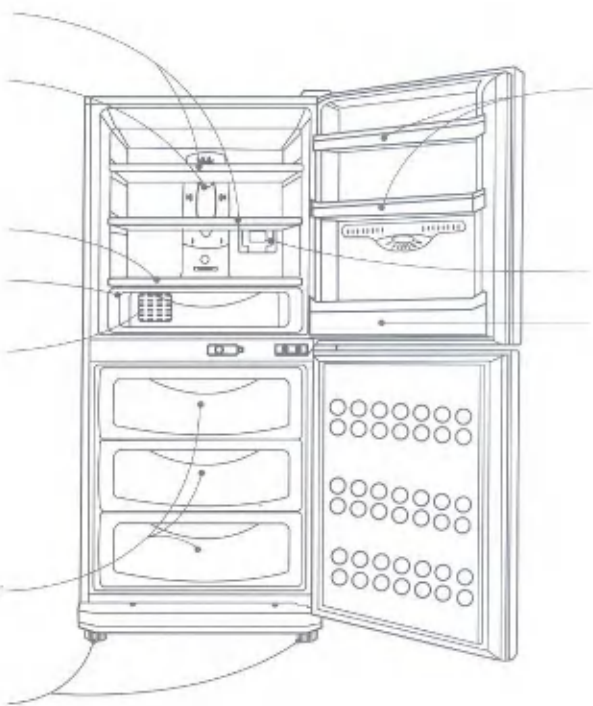

MOVEMENT & TRANSPORTATION

● BEFORE TRANSPORTATION

1. Remove all the food from the refrigerator, secure the spare parts such as the shelves by adhesive tape.
2. Fasten the adjustable foot to the  direction.



● DURING TRANSPORTATION

1. Hold tightly the adjustable foot at the bottom of the refrigerator and the upper handle at the back.
2. During transportation, please note that the refrigerator should not be tilted.
3. When transporting to a remote distant place, the refrigerator should be placed vertically in the vehicle. (Otherwise problem will exist).

Note: Please fasten the adjustable foot to the  direction before transportation, otherwise the floor will be scraped or the foot will be blocked from moving.

EARTH CONNECTION

- Note: 1. The earth wire of this electrical appliance has been connected to the power plug, please do not change the power plug on your own.
2. Plug your refrigerator into a standard **220-240V household outlet/male sun the socket is** properly earthed.
 3. If you receive an electrical shock by touching any part of the refrigerator, you should stop using the refrigerator immediately and contact the specified maintenance service unit or the retail shop of this product at once.

POWER CORD REPLACEMENT

If the supply cord is damaged, it must be replaced by a special cord or assembly from the manufacturer or its service agent.

INSTALLATION

● Installing on a firm and flat surface

- Unstable installation is the main reason of vibration and noise.
- When the refrigerator is installed unstably, it can be stabilized by adjusting the adjustable foot.
- Slightly rising the front part of the refrigerator allow you to close the door very easily.
- When installed on a carpet or floor, please put a firm mat under the refrigerator otherwise the bottom part will change colour.

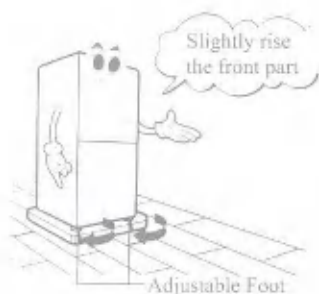

● Keep an appropriate distance between the wall

- During installation, the refrigerator should be kept an appropriate distance between the wall.
- A small gap will restrict the operation of the refrigerator, which may result in an increase in power.

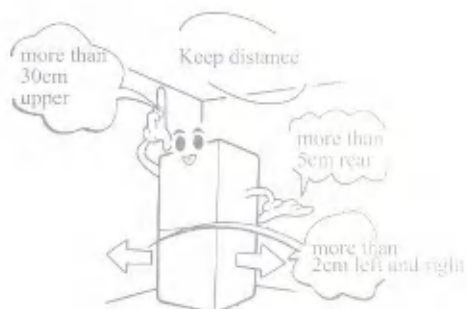

● Installing in a less humid environment

- Do not install the refrigerator in a humid place or where water can easily be splashed.
- If the refrigerator is installed in a humid environment, it will go moldy. This will lower insulation property and cause electricity leakage.

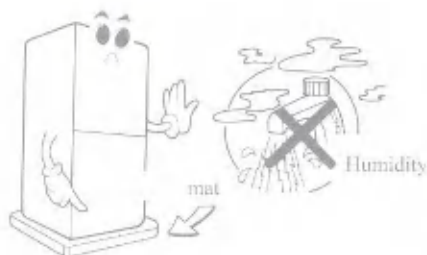

● Avoid installing near heat and gas

- High temperature will lower the refrigeration and increase the power consumption.
- Installing near gas or smoke will change the surface colour of the refrigerator.

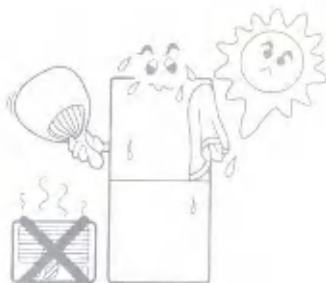

PLEASE FAMILIARISE WITH THE FOLLOWING PARTS

**Refrigerator
Compartment Shelf**

► Food containing a high water content will freeze if stored in the inner part of the refrigerator due to low temperature.

**Refrigerator
Compartment Cooling
Air Inlet**

► Cooling air is evenly blown from the inlet into the refrigerator compartment.

**Fruit & Vegetable
Compartment**

► To store vegetable and fruits etc.

**Refrigerator
Compartment Cooling
Air Suction Inlet**

► Please do not block this inlet as it will restrict the circulation of the cooling air flow.

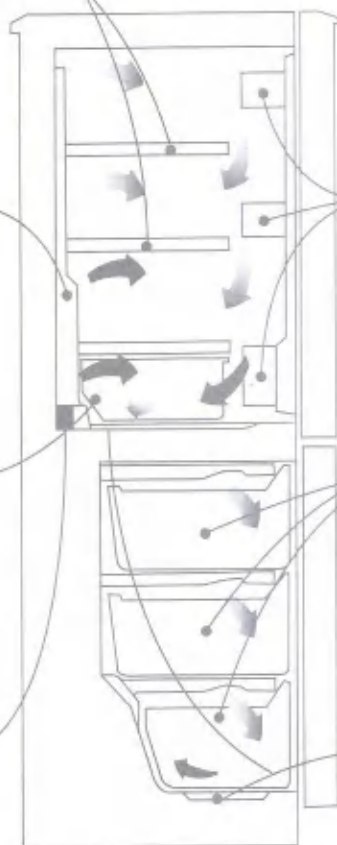

**Refrigerator
Compartment
Door Rack**

► For the storage of small size foods and bottles.

**Freezing
Compartment
Drawer**

► Please install it according to the size of frozen food.

**Note:(Cooling Air
Suction Inlet)**

► Please do not take away the freezing compartment drawer or the refrigerator fruit and vegetable compartment, otherwise the operation will be affected.

FUNCTION OPERATING AND DISPLAY

● Please use the control panel in front of the Refrigerator before operate.

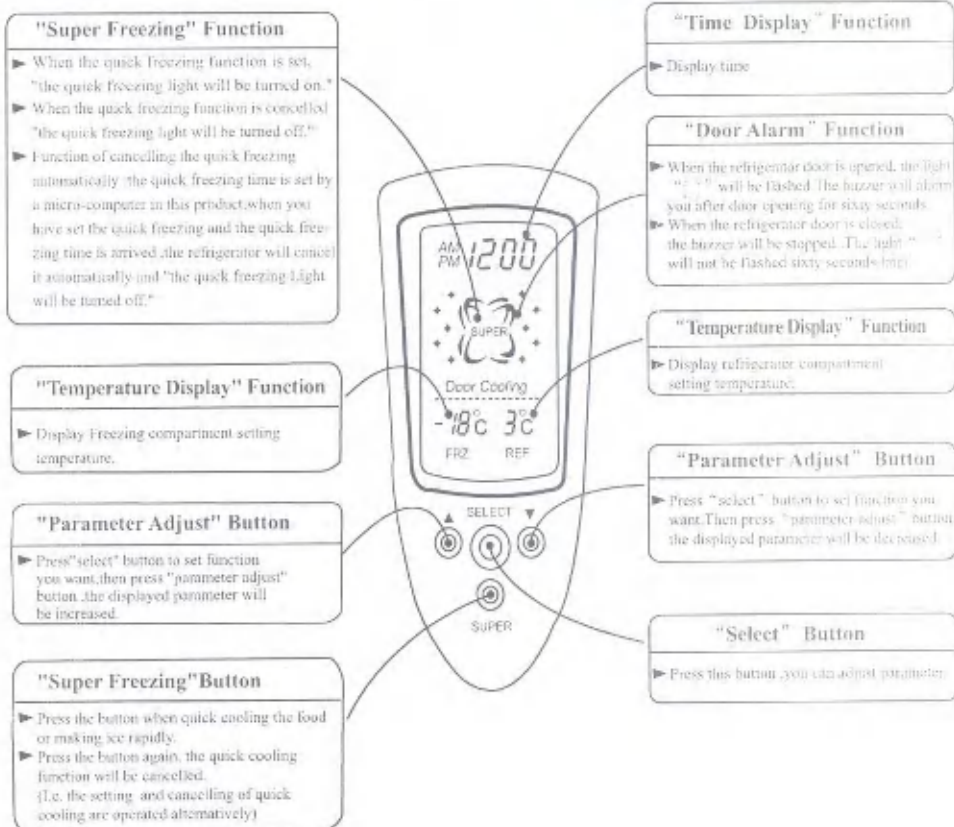

● Display panel Function and How to operate:

1. Set time

- ① Press "select" button till the time clock parameter will be flashed.
- ② Use "parameter adjust" button to set hours.
- ③ Press "▲" each time, the hour parameter will be changed by "AM12" → "AM1" → ... → "AM11" → "PM12" → "PM1" → ... → "PM11" → "AM12". If press it continually, the parameter will be changed rapidly.
- ④ Press "▼" button, the sequence is reverse to "▲".
- ⑤ Press the "select" button again, the minutes parameter will be flashed.
- ⑥ Use "parameter adjust" button to set minute.
- ⑦ Press "▲" each time, the minute parameter will be changed by "00" → "01" → ... → "59" → "00". If press "▼" button continually, the parameter will be changed rapidly.
- ⑧ Press "▼" button, the sequence is reverse to "▲".

FUNCTION OPERATING AND DISPLAY

2. Set Freezing compartment temperature.

- ① Press "select" button till the FRZ parameter will be flashed.
- ② Use "parameter adjust" button to set freezing compartment temperature.
- ③ Press "▲" button each time ,the temperature parameter will be changed by " -18℃" → " -15℃" → " -22℃" → " -18℃" . If you press it continually, the parameter will be changed rapidly.
- ④ Press "▼" button, the sequence is reverse to "▲" .

3. Set refrigerator compartment temperature.

- ① Press "select" button till the "REF" parameter will be flashed.
- ② Use "parameter adjust" button to set refrigerator compartment temperature.
- ③ Press "▲" button each time ,the temperature parameter will be changed by "3℃" → "8℃" → "0℃" → "3℃" . If press it continually, the parameter will be changed rapidly.
- ④ Press "▼" button, the sequence is reverse to "▲" .

Note:

When the refrigerator is the first time on power, the time is Am 12:00, the FRZ temperature is -18℃ and the REF temperature is 3℃ . So you can set function parameter now.

- ① The display parameter is the same as the first time on power after the power was cut off for five minutes later, the function parameter must be set again.
- ② When the back light is on, you press the "select" button every time . The cursor select "hour" , "minute" , "FRZ" , "REF" in turns. The parameter cursor flash, then use "parameter adjust" button to set.
- ③ After refrigerator compartment temperature is set and press "select" button again, then all the function parameter is set.
- ④ When the back light is on, you stop to operate for more than sixty seconds. The back light will be turned off automatically.
- ⑤ When the back light is off, you press any button. The back light will be on. You can set function parameter.

METHODS OF MAKING ICE

- **Making Ice** Pour water into the ice cube maker, and then store the maker in the freezing compartment drawer.
- **Removing Ice** Grasp both sides of the ice cube maker, twist once according to the picture and the ice can be removed. soak the ice Maker in the water for a while, it will be easier to remove the ice.

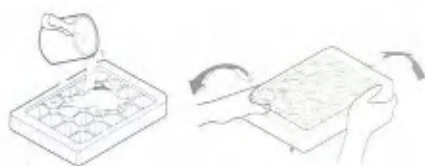

WAYS TO DISASSEMBLE SPARE PARTS

Refrigerator Shelf

- ▶ Slightly rise the front part of the shelf, then pull outward.

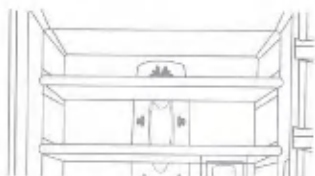

Fruit & Vegetable Compartment

- ▶ Fruit & Vegetable Compartment pull outward.
- ▶ Fruit & Vegetable Cover—pull the fruit & Vegetable compartment first, lift upward and pull outward.



Refrigerator Lamp

Pull out the power plug before removing

- ▶ Light Cover—insert the screwdriver into the groove on the top and the center of right side, then slightly pull the cover out.
- ▶ Light Bulb—screw out the bulb according to the direction shown in the picture.
- ▶ Refrigerator lamp is 15W especially for refrigerator.

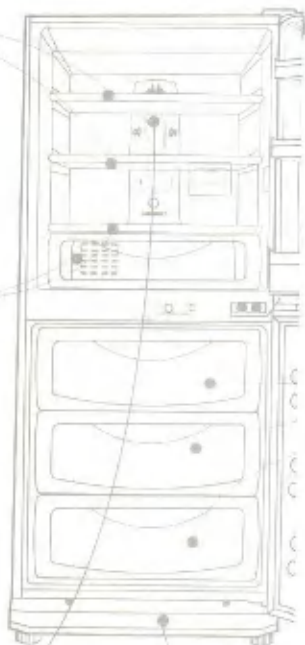

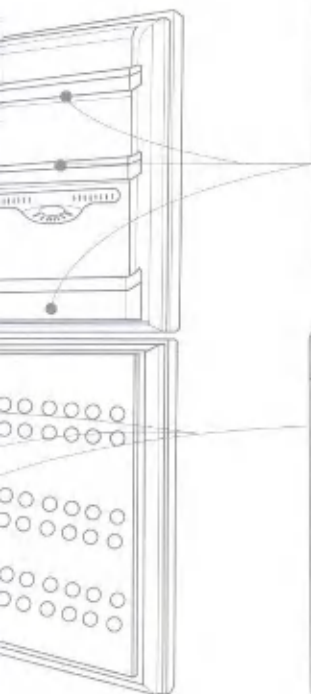

Refrigerating Compartment Door Rack

- ▶ Grasp both sides, lift upward and then pull outward.



Freezing Compartment Drawer

- ▶ Pull outward. Rise it slightly and then take it out.

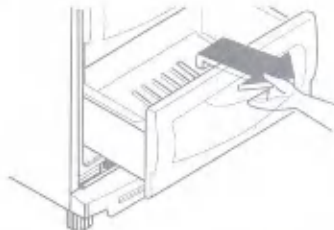

Bottom Cover

- ▶ Remove the two screws which hold the Bottom Cover, grasp both sides and then pull outward.

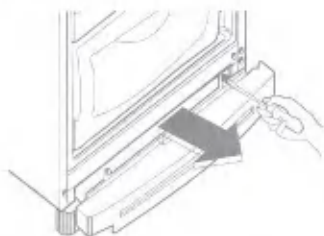

◆ Evaporating Pan

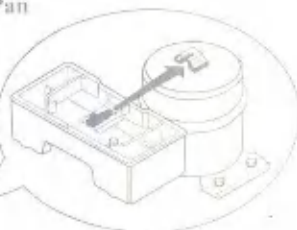

- ▶ Grasp the defrosting basin and slightly press downward while pulling outward.
- ▶ Installation: Note the direction of the arrow in the picture, push the pan into the hole on top of the compressor until you hear a click, then the basin is installed properly.

BEST WAYS TO STORE FOOD

Storing the food

- **Store foods which are easily frozen on the outer part of the refrigerator shelf.**

- If foods which are easily frozen or contain a high water content are stored on the inner part of the refrigerator shelf, it will be frozen due to low temperature.



- **Store the food or other things after cleaning and wiping.**

- Store vegetables and fruits after cleaning and wiping. Packed food like bottles should be stored after wiping to avoid polluting the other foods.



- **Storing heated food after cooling.**

- Storing the heated food directly in the refrigerator will affect the other foods inside and will also cause higher power consumption.



- **Do not store bottles in the Freezing Compartment.**

- If the bottles are stored in the freezing compartment, the liquid inside will be frozen and break the bottle.
- The volume of liquid such as juice or water should not exceed 80% of the container's volume.



- **Store the food after packing or putting into tight container.**

- Packing the food before storing can prevent drying. This can also reduce odour when storing the food for a longer time.

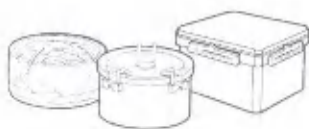

DOOR COOLING FUNCTION

FEATURE

There is cooling air duct on the refrigerator door. The cooling air flows directly to the door basket inside so food will be cooled quickly.



DEODORISATION

FEATURE

When the Active Deodorizer is used:

- Remove odour inside the refrigerator without producing any harmful effect to the food.

Active
Deodorizer



HOW TO USE IT?

- Active deodorizer is installed at the cooling air suction inlet of the refrigerator compartment.
- Please do not puncture the suction inlet by sharp solid. (otherwise the active deodorizer will be damaged)
- Please pack the strong smelling foods or store them in a tight container to avoid odour.

FRUIT & VEGETABLE COMPARTMENT

For storing fresh fruit and vegetables.

When using the Fruit & Vegetable Compartment

- If there is any water in the compartment, the food will rot. Therefore please remove water before storing the food.

- At the bottom of refrigerator compartment (i.e. the bottom part of fruit & vegetable compartment) is the cooling air suction inlet. You must not take out the fruit & vegetable compartment and put the food directly on the bottom part. Otherwise the operation of refrigerator will be affected.

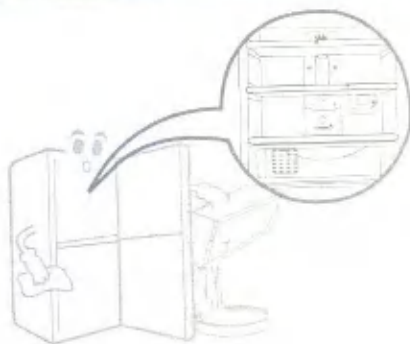

CLEANING THE REFRIGERATOR

● Before cleaning

- Unplug the refrigerator first to ensure safety.



● Shelf and door rack

- Places are easily made dirty by food. The inside of the refrigerator must be kept clean.



● Cooling air suction inlet in the refrigerating and freezing compartment.

- Please do not stick other things on the inlet during cleaning.



● Do not shower the refrigerator with water.

- This may cause an electrical shock.



● After cleaning please check whether:

1. The wire is damaged.
2. The power plug is not overheating.
3. The power plug is inserted properly.



● Surface of refrigerator

- Clean it with a soft cloth using a soapy cleanser, then dry with a clean cloth.



● Magnetic door seal

- If the door seal is dirty or covered in juice for a long time, the effectiveness of magnetic door seal will be reduced.
- Regular cleaning is necessary.



● Fruit & Vegetable Compartment

- A place that will easily store water. Too much water will rot the food, therefore the compartment should be taken out and cleaned regularly.



● Please do not clean the refrigerator with the following things:

- Cleaning powder, petrol, benzene, salt, acid, boiling water and brush etc. as they will damage the surface of refrigerator. Therefore please do not use them.



SAFETY GUARDS

- **Please use the exclusive power socket.**

- If the refrigerator uses the same power socket as other electrical appliances, the socket could be overloaded abnormally and fire may be resulted, which may cause a fire.



- **Please note that the back of the refrigerator should not touch the power plug.**

- Power plug could be easily damaged and this may cause fire or electric shock.



- **Please unplug the refrigerator first before cleaning. Do not do this with wet hands.**

- This may probably cause electric shock.



- **Please do not store flammable things like ether, benzene, alcohol and liquefied oxygen in the refrigerator.**

- This may cause explosion.



- **Please unplug the refrigerator before changing the light bulb.**

- Otherwise this may cause an electric shock.



- **Please do not put heavy things on top of the refrigerator.**

- When you open the door, the heavy thing could easily fall down and hurt you.



- **Please do not climb on the door.**

- The refrigerator could be turned over and hurt small children.



- **Please do not store medicine or academic information in the refrigerator.**

× Things which require strict temperature control should not be stored in the refrigerator, otherwise they will go bad or produce accidental effect.



SAFETY GUARDS

- Please keep away from fire.

- Can cause fire.

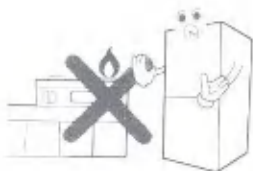

- In case of a gas leak, please do not touch the refrigerator and the power socket, you should open the windows and the door for ventilation.

- As a spark may cause an explosion and lead to fire.



- Please do not place water container such as vases, glasses, cosmetic or medicine on top of the refrigerator.

- Liquid spilt over the refrigerator will reduce the insulation effect, and may cause an electric shock or fire.



- Please do not store bottles in the freezing compartment.

- Liquid inside the bottle will be frozen and the bottle will break.



- Please do not install in a humid place or where water can easily be splashed.

- This will reduce the insulation effect and may cause an electric shock.



- Please unplug the refrigerator if it is not to be used for a long time.

- Reduced insulation may cause an electric shock or fire.



- During transportation, please hold the adjustable feet at the bottom of the refrigerator and the upper handle at the back.

- Otherwise, the refrigerator may fall down.

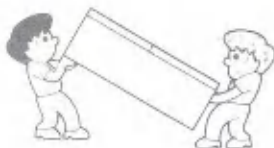

- When the refrigerator is unplugged, please wait for five minutes before you plug it again.



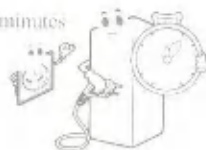

- Otherwise the compressor will be overloaded.

after 5 minutes



DOES THE REFRIGERATOR HAVE A MALFUNCTION?

If the refrigerator still does not work properly after checking the following tasks, please unplug the refrigerator and immediately contact the specified maintenance service unit or the retail shop of this product.

Situation	Please check
<p>The refrigerator does not operate</p> 	<ul style="list-style-type: none"> ➡ Is there a power failure? ➡ Is it 220-240V?
<p>Inefficient cooling</p> 	<ul style="list-style-type: none"> ➡ Is the refrigerator compartment temperature set too high? ➡ Is there any direct sunshine or heaters next by? ➡ Have you put some heated goods directly into the refrigerator? ➡ Have you stored too much food? ➡ Have you frequently opened the door of the refrigerator? ➡ Is the door closed properly? ➡ Have you kept an appropriate distance between the refrigerator and the wall? ➡ Is there any blockage in the air suction inlet of the refrigerator and freezing compartment?
<p>Food stored in the refrigerator compartment becomes frozen</p> 	<ul style="list-style-type: none"> ➡ Is the refrigerator compartment temperature set too low? ➡ Have you stored moist food that can easily be frozen in front of the cooling air inlet in the shelf?
<p>Too much noise, abnormal sound</p> 	<ul style="list-style-type: none"> ➡ Is it the normal sound when the refrigerator starts to work or turn off the power? ➡ Installed on a unstable ground. Adjust feet to stabilise. ➡ Is the back of refrigerator too close to the wall? ➡ Is there anything fallen down near the refrigerator? ➡ Is there any other things placed on top of the refrigerator?

THIS IS NOT A MALFUNCTION

● The refrigerator dew forming on the surface.

- If the refrigerator is installed in a humid environment or if it is raining, there can be dew forming on the surface of the refrigerator. This is because moisture in the air touches the surface of the refrigerator.
- Please wipe it with a clean soft cloth.



● You hear a sound like flowing water.

- It is the sound produced when the compressor stops operating.
- It is the sound of flowing refrigerant in the cooling equipment.
- Sound can be produced by the contraction and expansion of the parts due to temperature changes inside the refrigerator.



● The surface of refrigerator is warm.

- A high temperature pipe which prevents dewing is installed inside the refrigerator. When the refrigerator begins to operate or when it is summer, the surface will become warm. Please do not worry because this is a normal effect.

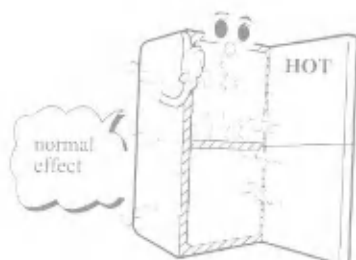

● The inner part of refrigerator compartment has dew forming.

- This is because the refrigerator is installed in a humid environment or the door is opened too long.
- Foods with a high water content are not packed well before storing.



APPENDIX

Appendix		GR-322SBF
Drawer	Freezing Compartment	3pieces
Shelf	Refrigerating Compartment	2pieces
Ice Cube Maker		1piece
Bottom Cover		1piece
Egg Holder		1piece
Fruit & Vegetable Compartment		1piece
Operation Manual		1piece