



DVD/CD/VCR RECEIVER

Home Cinema System

OWNER'S MANUAL

MODEL: LH-C6231

(Main Unit: LH-C6231W

Speakers: LHS-C6231T, LHS-C6231W)



Before connecting up, operating or repairing this product, please read this instruction booklet carefully and completely.



Safety Precautions



CAUTION
RISK OF ELECTRIC SHOCK
DO NOT OPEN



CAUTION: TO REDUCE THE RISK OF ELECTRIC SHOCK DO NOT REMOVE COVER (OR BACK) NO USER-SERVICEABLE PARTS INSIDE REFER SERVICING TO QUALIFIED SERVICE PERSONNEL.



This lightning flash with arrowhead symbol within an equilateral triangle is intended to alert the user to the presence of uninsulated dangerous voltage within the product's enclosure that may be of sufficient magnitude to constitute a risk of electric shock to persons.



The exclamation mark within an equilateral triangle is intended to alert the user to the presence of important operating and maintenance (servicing) instructions in the instructions accompanying the product.

WARNING: TO PREVENT FIRE OR ELECTRIC SHOCK HAZARD, DO NOT EXPOSE THIS PRODUCT TO RAIN OR MOISTURE.

WARNING: Do not install this equipment in a confined space such as a book case or similar unit.

CLASS 1 LASER PRODUCT
KLASSE 1 LASER PRODUKT
LUOKAN 1 LASER LAITE
KLASS 1 LASER APPARAT
CLASSE 1 PRODUIT LASER

CAUTION:

This DVD/CD/VCR receiver employs a Laser System.

To ensure proper use of this product, please read this owner's manual carefully and retain it for future reference. Should the unit require maintenance, contact an authorized service location (see service procedure).

Performing controls, adjustments, or carrying out procedures other than those specified herein may result in hazardous radiation exposure.

To prevent direct exposure to laser beam, do not try to open the enclosure. Visible laser radiation when open. **DO NOT STARE INTO BEAM.**

CAUTION: The apparatus should not be exposed to water (dripping or splashing) and no objects filled with liquids, such as vases, should be placed on the apparatus.

NOTES ON COPYRIGHTS:

It is forbidden by law to copy, broadcast, show, broadcast via cable, play in public, or rent copyrighted material without permission.

This product features the copy protection function developed by Macrovision. Copy protection signals are recorded on some discs. When recording and playing the pictures of these discs on a VCR, picture noise will appear.

This product incorporates copyright protection technology that is protected by method claims of certain U.S. patents and other intellectual property rights owned by Macrovision Corporation and other rights owners. Use of this copyright protection technology must be authorized by Macrovision Corporation, and is intended for home and other limited viewing uses only unless otherwise authorized by Macrovision Corporation. Reverse engineering or disassembly is prohibited.

SERIAL NUMBER: The serial number is located on the back of this unit. This number is unique to this unit and not available to others. You should record requested information here and retain this guide as a permanent record of your purchase.

Model No. _____

Serial No. _____

Table of Contents

Introduction

Safety Precautions	2
Table of Contents	3
Before Use	4-5
Playable Discs	4
Precautions	5
Notes on Discs	5
About Symbols	5
Front Panel Controls	6
Display Window Indicators	7
Remote Control Buttons	8
Rear Panel Connections	9

Preparation

Connections	10-14
TV & Set Top Box Connections	10
Accessory Audio/Video (A/V) Connections to DVD/CD/VCR receiver	11
Radio Aerial Connections	11
Speaker System Connection	12
Speaker Positioning	13
Mini Glossary	14
Before Operation - VCR part	15-19
Video channel Set	15
Using your receiver for the very first time	15
How to use the main menu	16
Tuning in TV stations Automatically	16
Tuning in TV stations Manually	17
Changing the order of TV stations	18
Deleting TV stations	18
Setting the clock Manually	19
To set the colour system	19
Before Operation - DVD part	20-23
General Explanation	20
On-Screen Display	20
Initial Settings	21-23
• General Operation	21
• Language	21
• Picture	21
• Speaker setup	22
• Others (DRC/Vocal/PBC/Auto play)	22
• Parental Control	23

Operation

Operation with Tape	24-27
Playing a tape	24
• CM (Commercial Message) SKIP	24
• OPR (Optimum Picture Response)	24
Instant Timer Recording (ITR)	25
Timer recording using On Screen Display	26-27
Operation with DVD and Video CD	28-30
Playing a DVD and Video CD	28
General Features	28
• Moving to another TITLE	28
• Moving to another CHAPTER/TRACK	28
• Search	28
• Still Picture and Frame-by-Frame Playback	29
• Slow Motion	29
• Repeat	29
• Repeat A-B	29
• Time Search	29
• 3D Surround	29
• Zoom	30
• Marker Search	30

Special DVD Features	30
• Title Menu	30
• Disc Menu	30
• Camera Angle	30
• Changing the Audio Language	30
• Changing the Audio Channel	30
• Subtitles	30

Operation with Audio CD and MP3/WMA Discs

Playing an Audio CD and MP3/WMA Discs	31
Notes on MP3/WMA Recordings	31
• Pause	32
• Moving to another Track	32
• Repeat Track/All/Off	32
• Search	32
• Repeat A-B	32
• 3D Surround	32
• Changing the Audio Channel	32

Operation with JPEG Disc

Programmed Playback

Programmed Playback with Audio CD and MP3/WMA Discs	34
Programmed Playback with Video CD	34
• Repeat Programmed Tracks	34
• Erasing a Track from Programme list	34
• Erasing the Complete Programme list	34

Speaker Setup

Additional Information

Additional Operation - VCR part

On Screen Display	36
Tape Counter Memory Stop	36
Friendly User Guide (Video Doctor)	36
ez (easy) Repeat	36
Hi-Fi Stereo Sound System	37

Special Recording

Copying from DVD to VCR	38
Recording from another video recorder	38



Radio Operation

Presetting the Radio Stations	39
Listening to the Radio	39
To Clear the Stored Radio Stations	39
Tuning into a Station Manually	40
Tuning into a Station Automatically	40

Reference



Language Code List	41
Country Code List	42
Troubleshooting	43-44
Specifications	45-46

About the symbols for instructions

-  Indicates hazards likely to cause harm to the unit itself or other material damage.
-  Indicates special operating features of this unit.
-  Indicates tips and hints for making the task easier.

Before Use

Playable Discs

	DVD (8 cm / 12 cm disc)
	Video CD (VCD) (8 cm / 12 cm disc)
	Audio CD (8 cm / 12 cm disc)

In addition, this unit can play a SVCD, DVD-RW, DVD+RW, Kodak PICTURE CD and CD-R or CD-RW that contains audio titles, MP3, WMA or JPEG files.

Notes

- Depending on the conditions of the recording equipment or the CD-R/RW (or DVD-RW, DVD+RW) disc itself, some CD-R/RW (or DVD-RW, DVD+RW) discs cannot be played on the unit.
- Do not attach any seal or label to either side (the labeled side or the recorded side) of a disc.
- Do not use irregularly shaped CDs (e.g., heart-shaped or octagonal). It may result in malfunctions.

Notes on DVDs and Video CDs

Some playback operations of DVDs and Video CDs may be intentionally fixed by software manufacturers. As this unit plays DVDs and Video CDs according to disc content designed by the software manufacturer, some playback features of the unit may not be available or other functions may be added.

Make sure to also refer to the instructions supplied with the DVDs and Video CDs. Some DVDs made for business purposes may not be able to be played on the unit.

Regional code of the DVD/CD/VCR receiver and DVDs

This DVD/CD/VCR receiver is designed and manufactured for playback of region “3” encoded DVD software. The region code on the labels of some DVDs indicates which type of player can play those discs. This unit can only play DVDs labeled “3” or “ALL”. If you try to play any other discs, the message “Check Regional Code” will appear on the TV screen. Some DVDs that have no region code label may still be subject to area restrictions and therefore not playable.



Disc-related terms

Title (DVD only)

The main film content or accompanying feature content or additional feature content, or music album.

Each title is assigned a title reference number enabling you to locate it easily.

Chapter (DVD only)

Sections of a picture or a musical piece that are smaller than titles. A title is composed of one or several chapters. Each chapter is assigned a chapter number, enabling you to locate the chapter you want. Depending on the disc, chapters may not be recorded.

Track (Video CD and audio CD only)

Sections of a picture or a musical piece on a video CD or an audio CD. Each track is assigned a track number, enabling you to locate the track you want.

Scene

On a video CD with PBC (Playback control) functions, moving pictures and still pictures are divided into sections called “Scenes”. Each scene is displayed in the menu screen and assigned a scene number, enabling you to locate the scene you want.

A scene is composed of one or several tracks.

Types of video CDs

There are two types of video CDs:

Video CDs equipped with PBC (Version 2.0)

PBC (Playback control) functions allow you to interact with the system via menus, search functions, or other typical computer-like operations. Moreover, still pictures of high resolution can be played if they are included in the disc.

Video CDs not equipped with PBC (Version 1.1)

Operated in the same way as audio CDs, these discs allow playback of video pictures as well as sound, but they are not equipped with PBC.

Before Use (Continued)

Precautions

Handling the unit

When shipping the unit

The original shipping carton and packing materials may come in handy. For maximum protection, re-pack the unit as it was originally packed at the factory.

When setting up the unit

The picture and sound of a nearby TV, VCR, or radio may be disturbed during playback. In this case, position the unit away from the TV, VCR, or radio, or turn off the unit after removing the disc.

To keep the exterior surfaces clean

Do not use volatile liquids, such as insecticide spray, near the unit. Do not leave rubber or plastic products in contact with the unit for a long period of time. They will leave marks on the surface.

Cleaning the unit

To clean the cabinet

Use a soft, dry cloth. If the surfaces are extremely dirty, use a soft cloth lightly moistened with a mild detergent solution. Do not use strong solvents such as alcohol, benzene, or thinner, as these might damage the surface of the unit.

To obtain a clear picture

The DVD/CD/VCR receiver is a high-tech, precision device. If the optical pick-up lens and disc drive parts are dirty or worn, the picture quality will be poor. Regular inspection and maintenance are recommended after every 1,000 hours of use. (This depends on the operating environment.)
For details, please contact your nearest dealer.

Notes on Discs

Disc Handling

Do not touch the playback side of the disc.
Hold the disc by the edges so that fingerprints will not get on the surface.
Do not stick paper or tape on the disc.

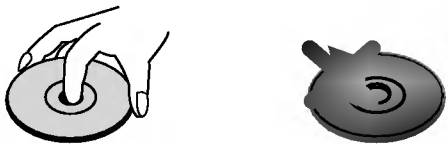

Storing discs

After playing, store the disc in its case.
Do not expose the disc to direct sunlight or sources of heat, or leave it in a parked car exposed to direct sunlight, as there may be a considerable temperature increase inside the car.

Cleaning discs

Fingerprints and dust on the disc can distort the picture or reduce sound quality. Before playing, clean the disc with a clean cloth. Wipe the disc from the centre outwards.

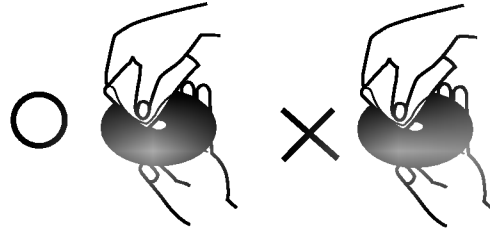

Do not use strong solvents such as alcohol, benzene, thinner, commercially available cleaners, or anti-static spray intended for vinyl records.







About Symbols

About the symbol display

"  " may appear on the TV screen during operation. This icon means the function explained in this owner's manual is not available on that specific DVD video disc.

About the disc symbols for instructions

A section whose title has one of the following symbol is applicable only to the disc represented by the symbol.

-  DVD
-  Video CDs with the PBC (playback control) function
-  Video CDs without the PBC (playback control) function
-  Audio CDs.
-  MP3 disc
-  WMA disc
-  JPEG disc

Setting the Output Source

You must select one of your output sources (DVD or VCR) to view on the TV screen.

- **If you want to view output source of DVD deck:**
Press DVD on the remote or DVD/VCR on the front panel until DVD indicator on the front panel lights and output source of DVD deck is viewed on the TV screen.
- **If you want to view output source of VCR deck:**
Press VCR on the remote or DVD/VCR on the front panel until VCR indicator on the front panel lights and output source of VCR deck is viewed on the TV screen.



Front Panel Controls

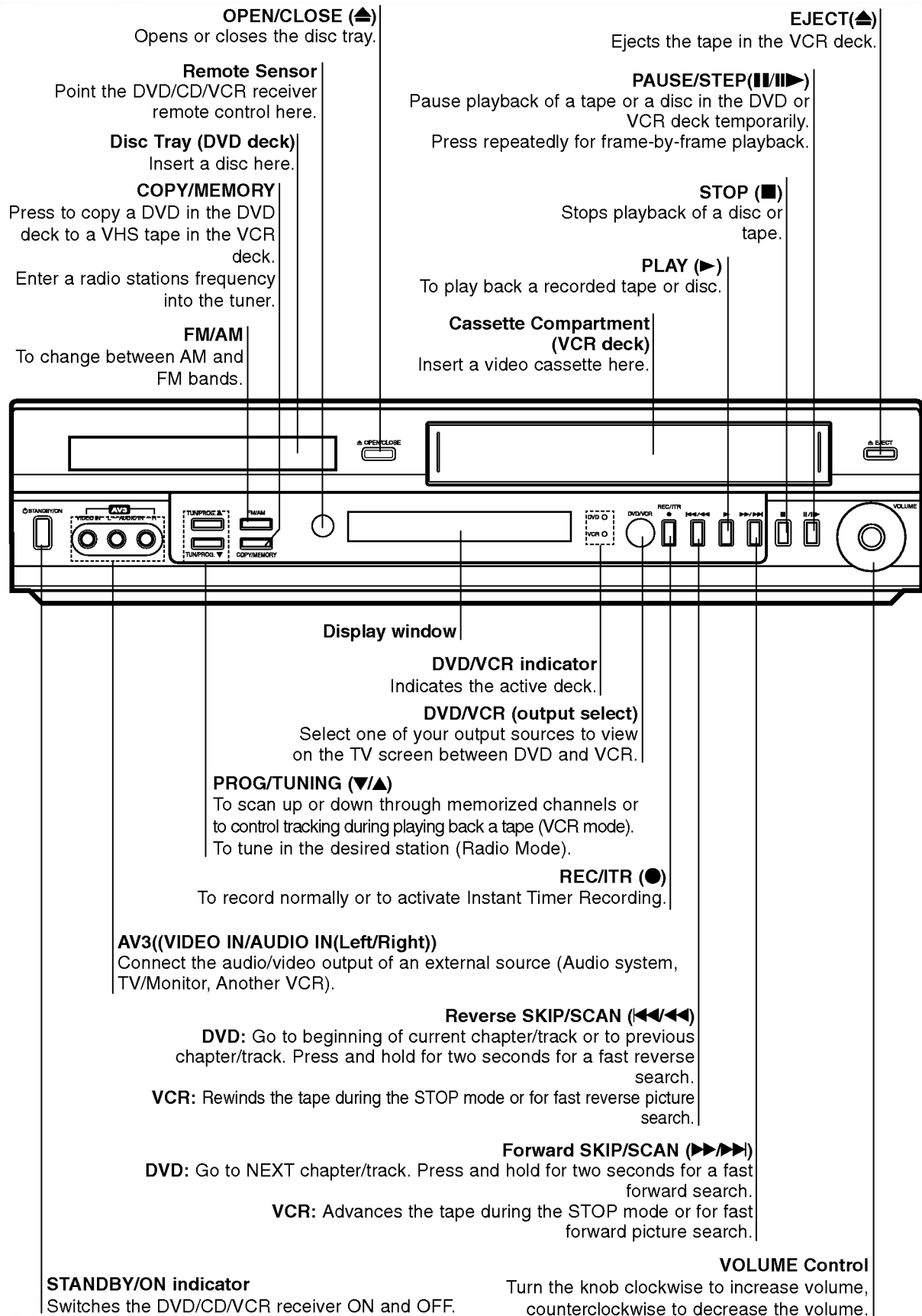

Display Window Indicators

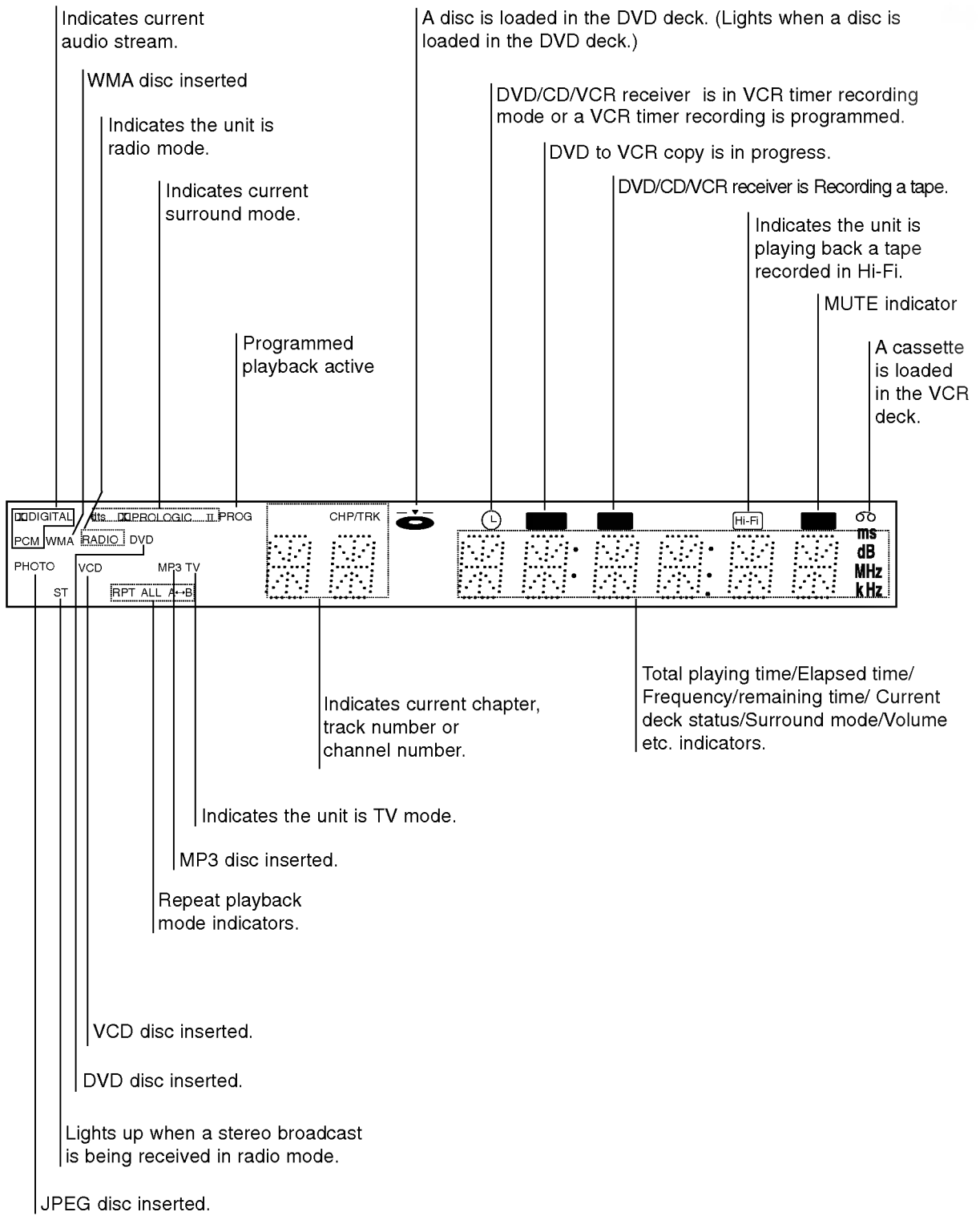

Remote Control Buttons

FM/AM Tuner select button
Select the DVD/CD/VCR receiver's tuner as the listening choice. (FM and AM bands)

OPEN/CLOSE, EJECT (▲)
- Opens and closes the disc tray.
- Ejects the tape in the VCR deck.

CD/DVD/VCR select buttons
Select the output source (CD/DVD or VCR) to view on the TV screen.

0-9 numerical buttons
Selects numbered options in a menu.

ANGLE
Selects a DVD camera angle if available.

PROGRAM
Accesses or removes Program menu.

ZOOM
Enlarges DVD video image.

MARKER
Marks any point during playback.

SEARCH
Displays MARKER SEARCH menu.

DISPLAY, CLK/CNT
Accesses On-Screen display.
Switches among the clock, tape counter and tape remaining modes on the display.

◀/▶/▲/▼ (left/right/up/down)
- Selects an option in the menu.

- PR/TRK/PRESET (▲/▼):
Select programme of VCR or Tuner
Adjusts manually the tape's picture onscreen.

- TUNING (◀/▶):
To tune in the desired radio station.

RETURN
Removes the setup menu.

CM SKIP
Fast forwards picture search through 30 seconds of recording.

STOP (■)
Stops playback.

REC/ITR (●)
Records normally or activates Instant Timer Recording.

REPEAT A-B/SPEED/REPEAT
- Repeat chapter, track, title, all.
- ez (easy) repeat (see page 36.)
- Repeats sequence.
- Selects recording speed.

TV/VCR
To view channels selected by the VCR tuner or by the TV tuner.

POWER
Switches DVD/CD/VCR receiver ON and OFF.

AV SELECT
Select input source.

MUTE
Momentarily silence the speaker of the DVD/CD/VCR receiver.

SOUND MODE
Selects sound mode between BYPASS, PRO LOGIC, PRO LOGICII (MOVIE, MUSIC, MATRIX) and 3D SURROUND.

CLEAR
Removes a track number on the program menu or a mark on the MARKER SEARCH menu.
Press to clear preset stations from the tuner memory.

AUDIO
Selects an audio language (DVD) or an audio channel (CD).

• **SUBTITLE**
Selects a subtitle language.

• **TITLE**
Displays the disc's Title menu, if available.

• **AV**
Selects the VCR deck's source (Tuner, AV1, AV2 or AV3).

• **VOLUME (+/-)**
Adjusts speaker volume.

SETUP/i
Accesses or removes DVD setup menu and VCR menu.

MEMORY/OK/ENTER
- Enter a radio stations frequency into the tuner.
- Displays functions on the TV screen.
- Acknowledges menu selection.

DISC MENU
Accesses menu on a DVD disc.

• **PAUSE/STEP (||/II▶)**
Pause playback or recording temporarily/press repeatedly for frame-by-frame playback.

• **PLAY (▶)**
Starts playback.

• **BACKWARD (◀◀)**
DVD: Search backward*/go to beginning of current chapter or track or go to previous chapter or track.
VCR: Rewinds the tape in STOP mode or for fast reverse picture search.

* Press and hold button for about two seconds.

• **FORWARD (▶▶)**
DVD: Search forward*/go to next chapter or track.
VCR: Advances the tape in STOP mode or for fast forward picture search.

* Press and hold button for about two seconds.

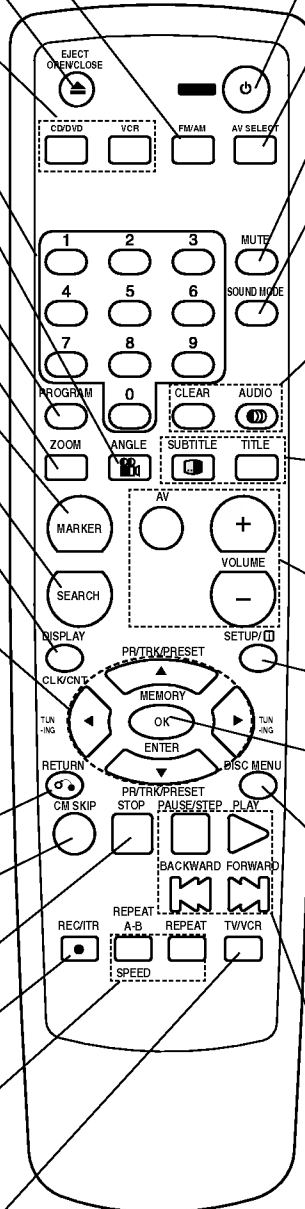

Note

This remote control use the same buttons for VCR and DVD functions (ex. PLAY).
To use the VCR, first press the VCR button.
To use the DVD, first press the CD/DVD button.



Rear Panel Connections

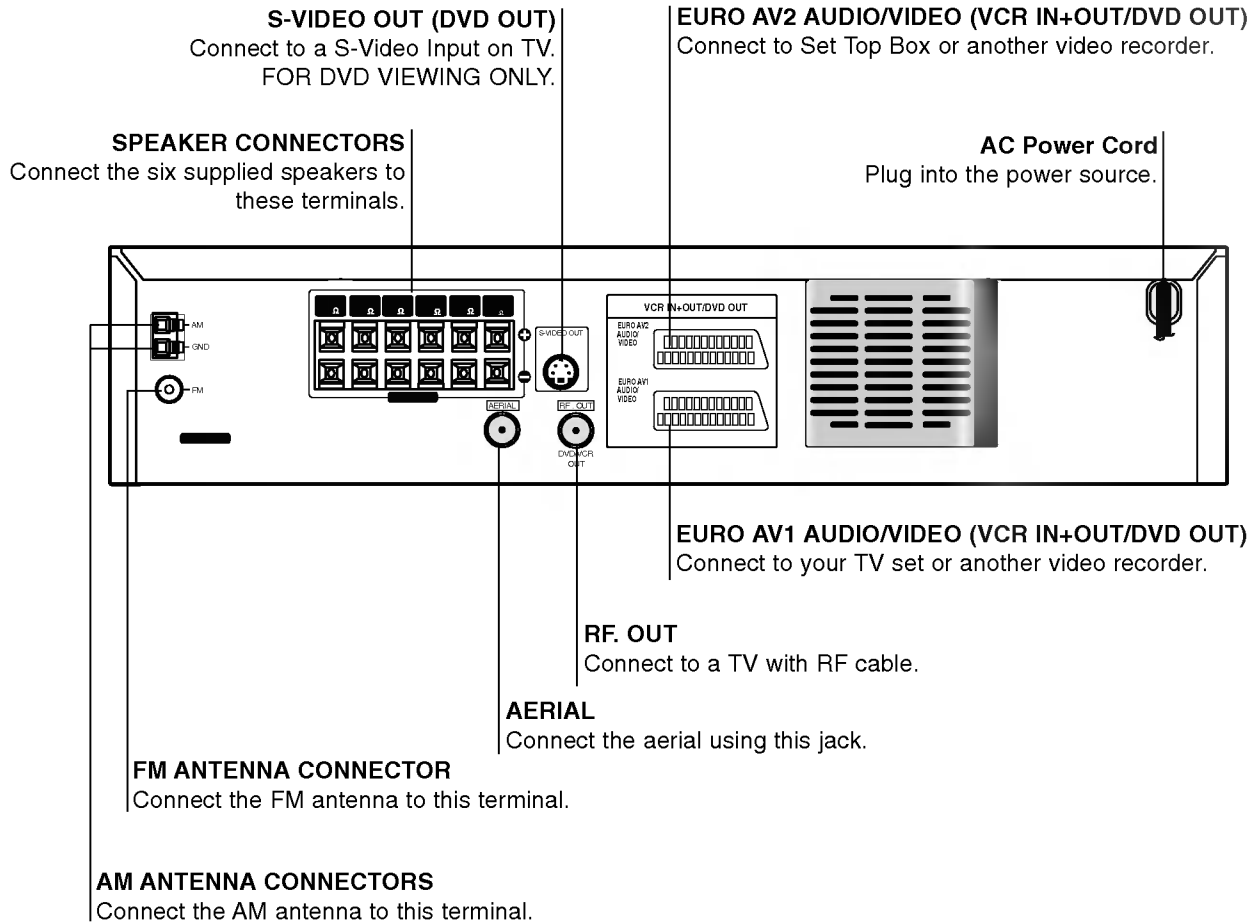

Do not touch the inner pins of the jacks on the rear panel. Electrostatic discharge may cause permanent damage to the unit.

Remote Control Operation Range

Point the remote control at the remote sensor and press the buttons.

- **Distance:** About 6m (20ft) from the front of the remote sensor
- **Angle:** About 30° in each direction of the front of the remote sensor

Remote control battery installation

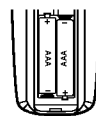

Detach the battery cover on the rear of the remote control, and insert two R03 (size AAA) batteries with **+** and **-** aligned correctly.



Caution
Do not mix old and new batteries. Never mix different types of batteries (standard, alkaline, etc.).



Connections

TV & Set Top Box (or another VCR Connections)

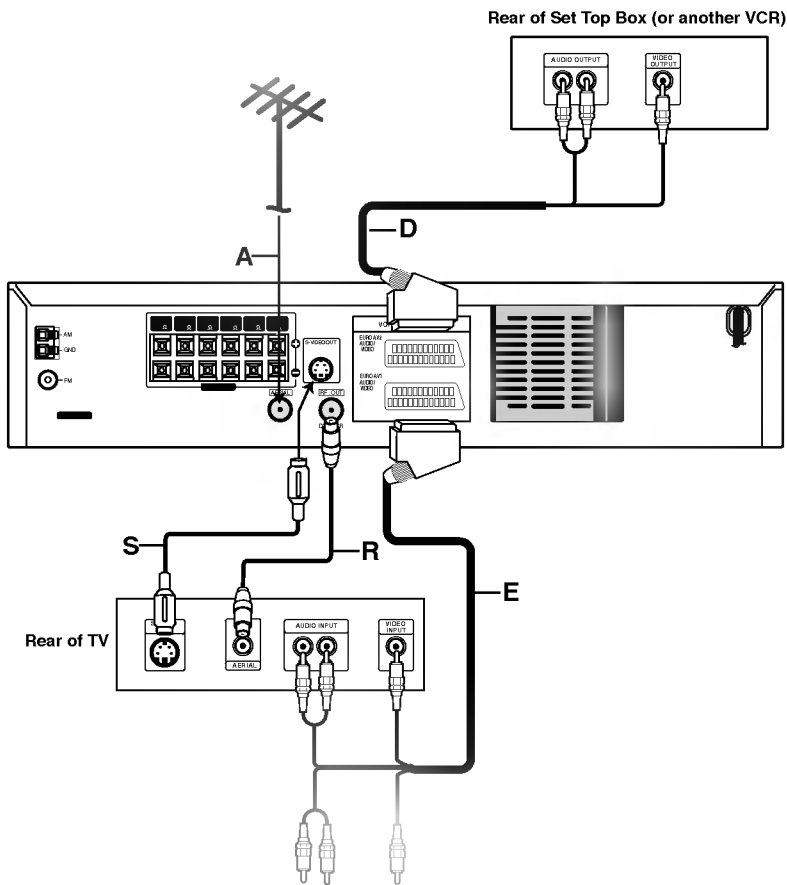

- Make one of the following connections, depending on the capabilities of your existing equipment.

Tips

- Depending on your TV and other equipment you wish to connect, there are various ways you could connect the DVD/CD/VCR receiver. Use one of the connections described below.
- Please refer to the manuals of your TV, VCR, Stereo System or other devices as necessary to make the best connections.

⚠ Caution

- Make sure the DVD/CD/VCR receiver is connected directly to the TV. Select the correct AV input on your TV.
- Do not connect your DVD/CD/VCR receiver to TV via your VCR. The DVD image could be distorted by the copy protection system.

Basic connections (AV)

- 1** Connect the **EURO AV1 AUDIO/VIDEO** on the rear panel of the DVD/CD/VCR receiver to the RCA input jacks on the TV using a RCA-SCART lead (**E**).
- 2** You can connect such a Set Top Box (or another VCR) to the DVD/CD/VCR receiver using a RCA-SCART lead (**D**).



Basic connections (RF)

- 1** Connect the aerial cable (**A**) from your indoor/ outdoor aerial to **AERIAL** jack on the rear panel of DVD/CD/VCR receiver.
- 2** Connect the supplied RF cable (**R**) from the **RF. OUT** jack on the rear panel of DVD/CD/VCR receiver to your television's Aerial Input.

S-Video connection

Connect the S-VIDEO OUT jack on the DVD/CD/VCR receiver to the S-VIDEO IN jack on the TV using the S-Video cable (**S**).

Notes

- The signal of S-VIDEO OUT jack will output only when the function mode is selected to CD/DVD.
- When you connect the DVD/CD/VCR receiver to your TV, be sure to turn off the power and unplug both units from the wall outlet before making any connections.

Connections (Continued)

Accessory Audio/Video (A/V) Connections to DVD/CD/VCR receiver

Connect the **AV3** jacks on the DVD/CD/VCR receiver to the audio/video out jacks on your accessory component, using the optional audio/video cables.

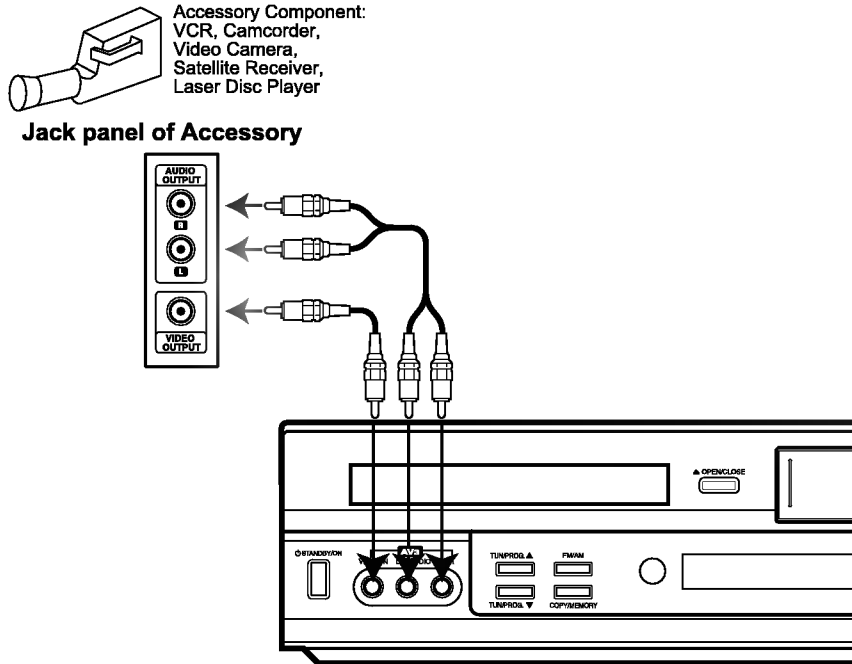

Radio Aerial Connections

Connect the supplied FM/AM aerial for listening to the radio.

- Connect the AM loop aerial to the AM aerial connector.
- Connect the FM wire aerial to the FM aerial connector.

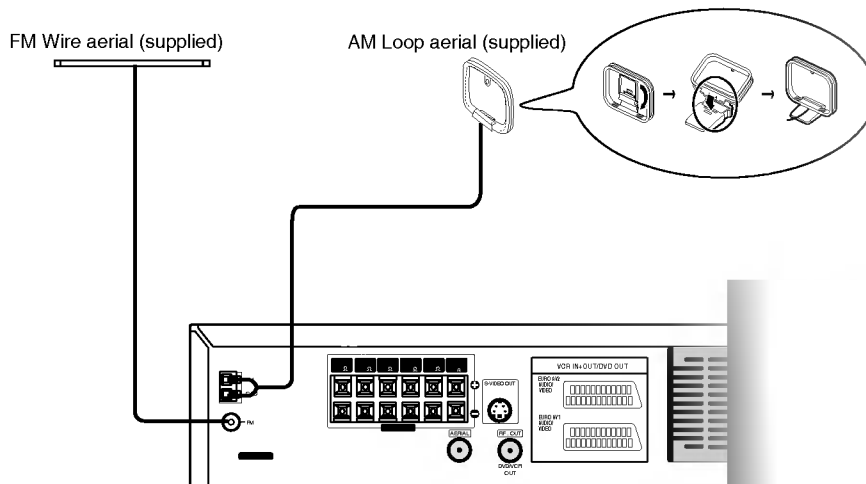

Notes

- To prevent noise pickup, keep the AM loop aerial away from the DVD/CD/VCR receiver and other components.
- Be sure to fully extend the FM wire aerial.
- After connecting the FM wire aerial, keep it as horizontal as possible.

Connections (Continued)

Speaker System Connection

Connect the speakers using the supplied speaker cords.

To obtain the best possible surround sound, adjust the speaker parameters; distance, level, etc..

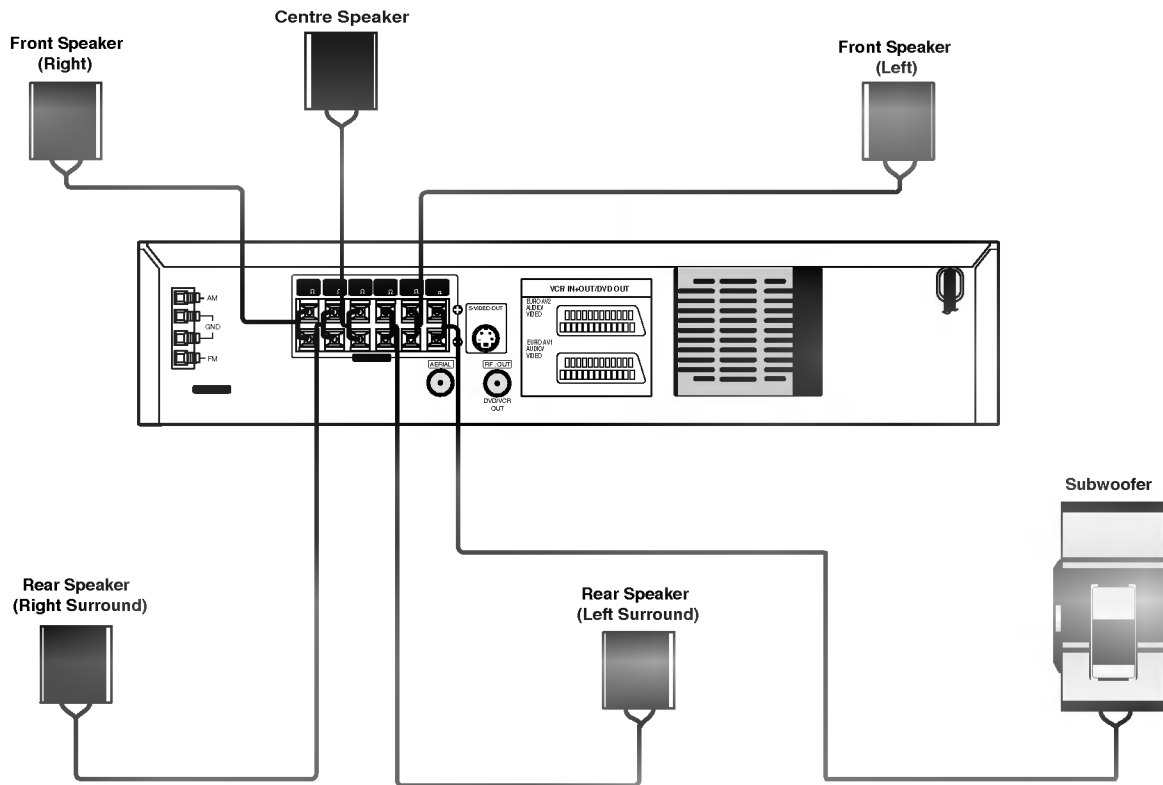

Notes

- Be sure to match the speaker cable to the appropriate terminal on the components: + to + and - to -. If the cables are reversed, the sound will be distorted and will lack base.
- If you use front speakers with low maximum input rating, adjust the volume carefully to avoid excessive output on the speakers.
- Do not remove the front cover of supplied speaker.

Connections (Continued)

Speaker Positioning

In the case of normal position use the 6 speakers (2 front speakers, centre speaker, 2 rear speakers and subwoofer).

If you want to play the excellent bass sound, DTS digital surround or Dolby Digital surround, you should connect a subwoofer.

- **Front speakers**

According to your listening position set up the speakers for equal distance. And by hearing position set up the interval between speakers to 45 degree.

- **Centre speaker**

The centre speakers and front speakers are ideally the same height. But normally place it above or below the television.

- **Rear speakers**

Place left and right behind the listening area. These speakers recreate sound motion and atmosphere required for surround sound playback. For best results, do not install the rear speakers too far behind the listening position and install them at or above the level of the listener's ears. It is also effective to direct the rear speakers towards a wall or ceiling to further disperse the sound.

In the case of a smaller room size, if the audience is near to the rear wall set the rear speakers opposite each other, and set the rear speakers above 60 - 90 cm than the listener's ears.

- **Subwoofer**

This can be placed in any front position.

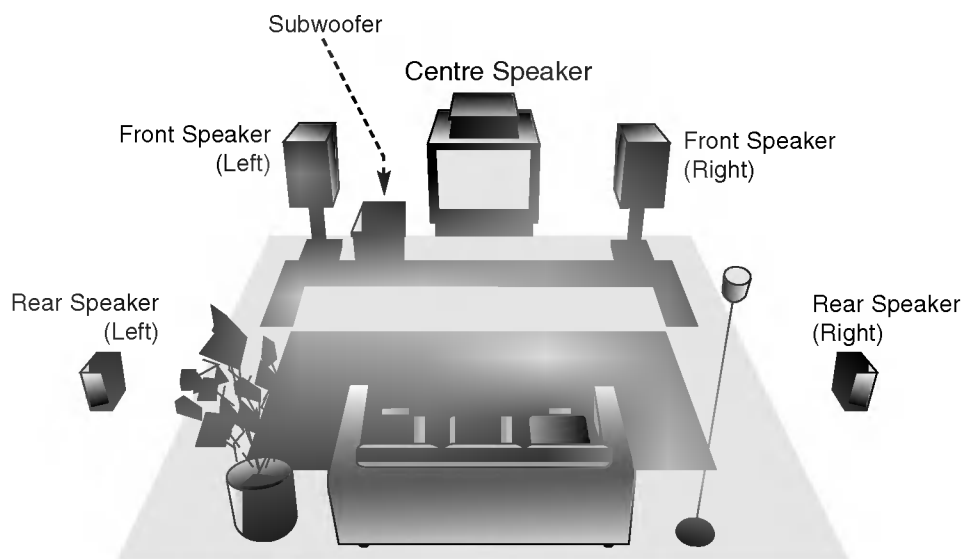

Speaker Positioning Example

Mini Glossary

Mini Glossary for Audio Stream & Surround mode

Ⓜ **dts**

Allows you to enjoy 5.1(or 6) discrete channels of high quality digital audio from DTS program sources such as discs, DVD and compact discs, etc.bearing the trademark. DTS Digital Surround delivers up to 6 channels of transparent audio(which means identical to the original masters) and results in exceptional clarity throughout a true 360 degree sound field. The term DTS is a trademark of DTS Technology, LLC. Manufactured under license from DTS Technology, LLC.

Ⓜ **DIGITAL**

The Dolby Digital surround format lets you enjoy up to 5.1 channels of digital surround sound from a Dolby Digital program source. If you play DVDs with “**Ⓜ**” mark, you can enjoy even better sound quality, greater spatial accuracy, and improved dynamic range.

Ⓜ **PRO LOGIC**

Use this mode when playing movie or Dolby Digital 2 channel which carries the “**Ⓜ**” mark. This mode provides the effect of being in a movie theatre or live concert house-an effect with an intensity which can only be obtained through DOLBY PRO LOGIC SURROUND. The effect of the front/back/left/right movement of the sound image, as well as the sense of fixed position in the sound image, is much clearer and more dynamic than before.

Ⓜ **PRO LOGIC (II)**

Dolby Pro Logic II creates five full-bandwidth output channels from two-channel sources. This is done using an advanced, high-purity matrix surround decoder that extracts the spatial properties of the original recording without adding any new sounds or tonal colorations.

MOVIE mode:

The Movie mode is for use with stereo television shows and all programs encoded in Dolby Surround. The result is enhanced soundfield directionality that approaches the quality of discrete 5.1-channel sound.

MUSIC mode:

The Music mode is for use with any stereo music recordings, and provides a wide and deep sound space. The Music mode includes controls that allow the sound to be tailored to individual listening tastes.

MATRIX mode:

The Matrix mode is the same as the Music mode except that the directional enhancement logic is turned off. It may be used to enhance mono signals by making them seem “larger.” The Matrix mode may also find use in auto systems, where the fluctuations from poor FM stereo reception can otherwise cause disturbing surround signals from a logic decoder. The ultimate “cure” for poor FM stereo reception may be simply to force the audio to mono.

3D SURROUND

This unit can produce a 3D Surround effect, using 3D Surround Sound technology, which simulates multi-channel audio playback from two conventional stereo speakers instead of the five or more speakers normally required to listen to multi-channel audio from a home theatre. This feature works with DVD discs encoded with Dolby Pro Logic and Dolby Digital audio tracks.

BYPASS

Software with multichannel surround audio signals is played according to the way it was recorded.

Sound Mode

You can enjoy surround sound simply by selecting one of the pre-programmed sound fields according to the program you want to listen to.

Press **SOUND MODE** repeatedly until the sound mode you want appears in the display window as below.

Each time you press **SOUND MODE** button, the sound mode is changed in the following order;

PRO LOGIC → PLII MOVIE → PLII MUSIC → PLII MATRIX → 3D SURROUND → BYPASS

When DVD is inserted.

You can change the stream of DVD (Dolby Digital, DTS, PCM, etc) by pressing the **AUDIO** button on the remote during playback.

Although the DVD contents differ from disc to disc, the following explains the basic operation when this feature is used.

Each time you press **AUDIO** button, the sound mode of DVD is changed as the following order;

Ⓜ **DIGITAL** → **Ⓜ** **dts** → **Ⓜ** **PCM** → **Ⓜ** **DIGITAL**

For your reference

- **The DVD/CD/VCR Receiver memorizes the last mode settings for each source individually.**
- **You can identify the encoding format of program software by looking at its packaging.**
 - Dolby Digital discs are labeled with the **Ⓜ** logo.
 - Dolby Surround encoded programs are labeled with the **Ⓜ** logo.
 - DTS Digital Surround discs are marked with DTS.

Note

- When you play sound tracks with 96kHz sampling frequency, the output signals will be converted to 48kHz (sampling frequency).

Before Operation - VCR part

Video channel Set

Video channel (RF output channel) is the channel on which your TV receives picture and sound signals from the DVD/CD/VCR receiver through the RF cable.

If you have used a RCA-SCART lead you will not have to tune your TV, simply select the **AV** channel. The **AV** channel is already pre-tuned for optimum video playback on your TV.

Perform the following steps only if interference appears in the TV picture after you have moved to a different area or a new station has started broadcasting in your area, or if you change the connection from RF connection to AV connection, or vice versa.

- 1** Turn on DVD/CD/VCR receiver and TV.
- 2** Set the vacant position 39 on your TV.
- 3** Press **POWER** on the remote control to enter the standby mode (the clock indicator will be dimmed).
- 4** Press and hold **PROG ▲** or **▼** on the DVD/CD/VCR receiver for more than 4 secs.

RF 39 will appear in the DVD/CD/VCR receiver display.

The following picture will be displayed on the TV screen.

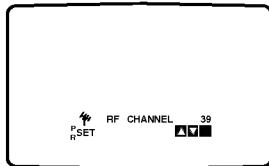

If the picture is snowy, move to step 5. If the picture is clean, press **POWER** on the DVD/CD/VCR receiver to finish.

- 5** Press **PROG ▲** or **▼** on the DVD/CD/VCR receiver to set the video channel to a vacant position between 22 and 68 which is not occupied by any local station in your area.

Note

The RF channel will not change until step 6 has been executed.

- 6** Press **POWER** on the DVD/CD/VCR receiver to store the new RF video channel into the DVD/CD/VCR receiver memory.

Now tune your TV set to the new DVD+VCR RF channel.

Note

If the TV picture was clear in step 4, do not retune your TV.

Using your Receiver for the very first time

For the following steps we assume that you have just connected your Receiver for the very first time. To make tuning TV stations an easy task your Receiver incorporates the **Automatic Channel Memory System (ACMS)**. This system will automatically tune and store TV channels in your Receiver.

- 1** Make sure that you have correctly installed your DVD/CD/VCR receiver.
- 2** Press **POWER** to turn on your DVD/CD/VCR receiver.

If the initial Menu Screen doesn't appear on screen, make sure that you have tuned your TV to a video channel. Or if this is correct it may mean that your DVD/CD/VCR receiver is already tuned.

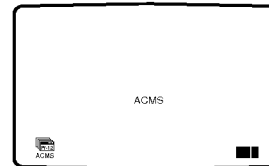

- 3** Press **OK** to start the automatic tuning process.

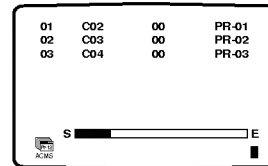

- 4** Press **i** to remove the menus from the TV screen.

Before Operation - VCR part

How to use the main menu

This DVD/CD/VCR receiver can easily be programmed by using the menus displayed on screen. The menus are controlled from the Remote Control Handset.

1 Switch on your TV set and DVD/CD/VCR receiver by pressing the POWER.

2 Press **i**. The main menu will appear on the TV screen.

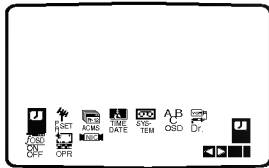

- **REC**
Timer recording setting (see p. 26-27).
- **PR SET**
Manual tuning setting (see p. 17).
- **ACMS**
ACMS (Automatic Channel Memory System) (see right column).
- **TIME DATE**
Date & clock setting (see p. 19).
- **SYSTEM**
To set the Colour TV System (see p. 19).
- **ABC OSD**
To change the language setting for OSD. You can select the language from English, Russian, German, French, Polish, Czech and Hungarian.
- **Dr.**
To check a problem with your DVD/CD/VCR receiver (see p. 36).
- **fOSD ON/OFF**
To display the operational mode of your DVD/CD/VCR receiver (see p. 36).
- **OPR**
To improve the playback picture (see p. 24).
- **NIC**
To activate or deactivate the NICAM digital sound (see p. 37).

3 Press **◀** or **▶** to select the desired menu.

4 Press OK and press **▲** or **▼** to select.

5 Press **i** to return to a TV picture.

Tuning in TV Stations Automatically

Should you wish to perform the **Automatic Channel Memory System (ACMS)** again please follow the guidance given on this page. You may tune up to 88 TV stations into your DVD/CD/VCR receiver.

1 Press POWER to turn on your DVD/CD/VCR receiver.

2 Press **i**. The main menu will appear on the TV screen.

3 Press **◀** or **▶** to select ACMS and press OK.

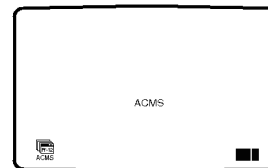

4 Press OK again to start the automatic tuning process.

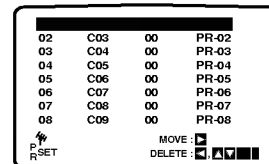
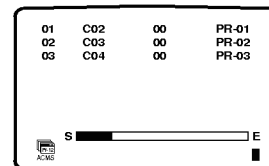

5 Press **i** to remove the menus from the TV screen.

Before Operation - VCR part

Tuning in TV Stations Manually

In certain areas of the country broadcast signals may be too weak for your DVD/CD/VCR receiver's automatic tuning process to find or assign TV stations correctly. You must tune in these weaker broadcast stations manually in order for your DVD/CD/VCR receiver to store them.

- 1** Press **i**.
The main menu will appear on the TV screen.
- 2** Press **◀** or **▶** to select **PR SET** and press **OK**.

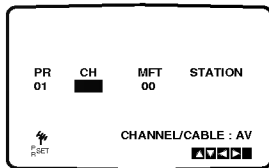

- 3** Press **i** and press **▲** or **▼** to select the programme number that you want to tune (for example, **PR 07**). Press **OK**.

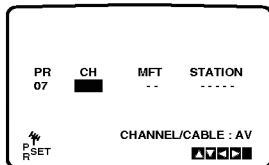
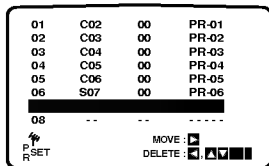

- 4** Press **AV** to select **C** (Standard stations) or **S** (Cable stations): **C02 - C70, S01 - S41**.

Enter the channel number of station that you want to tune with the **numerical buttons**.

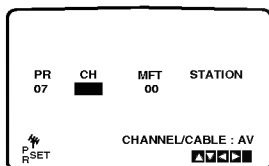

- 5** Searching will stop when it locates a station.
Control the fine tuning of the station by pressing **▲** or **▼**.

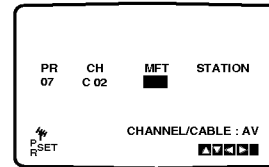

- 6** Press **▶** to select **STATION** and press **OK**.

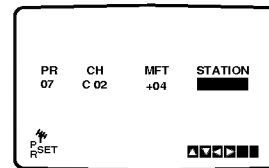

- 7** Press **▲** or **▼** to select letters and numbers for the new station name.

Press **◀** or **▶** to move back and forth between characters. Press **OK**.

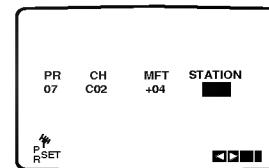

- 8** Press **i**, confirm the station placement.

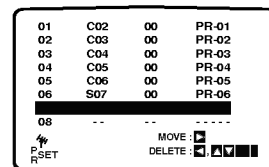

- 9** Press **i** to remove the menus from the TV screen.

Your new TV station has now been tuned into your DVD/CD/VCR receiver.

If you wish to manually tune other stations repeat stages **1 - 8**.



Before Operation - VCR part

Changing the order of TV Stations

After tuning TV stations into your DVD/CD/VCR receiver you may wish to **change** the order in which they are stored without having to retune them. The instructions given on this page will show you how you can simply move them into your desired order

- 1 Press **i**.
The main menu will appear on the TV screen.
Press **◀** or **▶** to select PR SET and press OK.

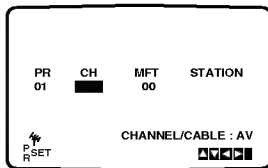

- 2 Press **i**.
Press **▲** or **▼** to select the programme number you want to move (for example, PR 03).
Press **▶**.

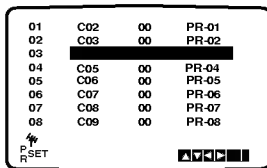

- 3 Press **▲** or **▼** to select the programme number you want to move to (for example, PR 05).

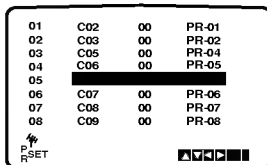

- 4 Press OK.
The selected **programme** will be moved to the **new programme number**.

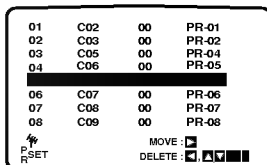

- 5 Press **i** to remove the menus from the TV screen.

If you wish to move other TV stations repeat stages 1 - 4.

Deleting TV Stations

After tuning TV stations into your DVD/CD/VCR receiver you may wish to **delete** a station. The instructions given on this page will show you how to easily delete any unwanted TV stations.

- 1 Press **i**.
The main menu will appear on the TV screen.

Press **◀** or **▶** to select PR SET and press OK.

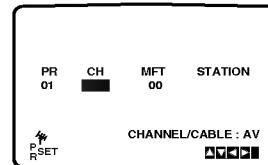

- 2 Press **i**.
Press **▲** or **▼** to select the programme number you want to delete (for example, PR 03).

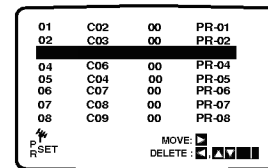

- 3 Press **◀**.
After a short while, the selected station will be deleted.

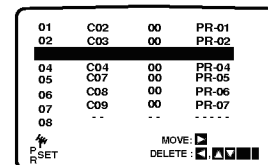

- 4 Press **i** to remove the menus from the TV screen.

If you wish to delete other TV stations repeat stages 1 - 3.

How to select Stored TV stations:

Stored TV stations can be selected in either of two ways.

Press **▲** or **▼** to select different stations that are tuned into your DVD/CD/VCR receiver.

You may also directly select stations using the **numerical buttons** on the remote control.

Before Operation - VCR part

Setting the Clock Manually

- 1 Press **i**.
Press **◀** or **▶** to select **TIME DATE** and press **OK**.

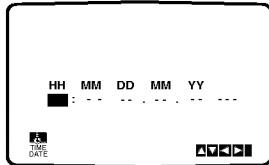

- 2 Use the numerical buttons or press **▲/▼** or **◀▶** on the remote control to alter the **HOURS, MINUTES, DAY, MONTH** and **YEAR**.

Please note your DVD/CD/VCR receiver uses a 24-hour clock. e.g. 1pm will be displayed as 13:00.

The day of the week will appear automatically when you enter the year.



- 3 If you make a mistake, press **◀** or **▶** and enter the correct details.
- 4 Press **i** to remove the menus from the TV screen.

Your new clock settings are stored and will appear on your DVD/CD/VCR receiver's Display.

To set the colour system

Your DVD/CD/VCR receiver is equipped with dual colour standard, you can play back a tape in PAL and MESECAM.

During playback your DVD/CD/VCR receiver detects the colour system automatically.

If there is any colour problem please select the colour system manually.

- 1 Press **i**.
The main menu will appear on the TV screen.

- 2 Press **◀** or **▶** to select the **SYSTEM**.

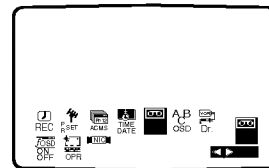

- 3 Press **OK** and press **▲** or **▼** to select according to the **COLOUR** system used.

AUTO:

Allows PAL or MESECAM signals to be distinguished automatically.

PAL:

Use when receiving PAL signals or use when playing back a tape recorded in PAL system.

MESECAM:

Use when receiving MESECAM signals or use when playing back a tape recorded in MESECAM system.

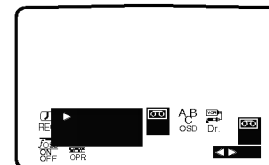

- 4 Press **◀** or **▶** to select the **RF AUDIO** and press **▲** or **▼** to select according to the **RF AUDIO** used.



- 5 Press **i** to remove the menus from the TV screen.

Before Operation - DVD part

General Explanation

This manual gives basic instructions for operating the DVD/CD/VCR receiver. Some DVDs require specific operation or allow only limited operation during playback. When this occurs, the symbol  appears on the TV screen, indicating that the operation is not permitted by the DVD/CD/VCR receiver or is not available on the disc.

On-Screen Display

General playback status can be displayed on the TV screen. Some items can be changed on the menu.









On-screen display operation

1 Press DISPLAY during playback.

2 Press ▲▼ to select an item.
The selected item will be highlighted.







3 Press ◀▶ to change the setting of an item.
The number buttons can be also be used for setting numbers (e.g., title number). For some functions, press ENTER to execute the setting.





Temporary Feedback Field Icons

-  Repeat Title
-  Repeat Chapter
-  Repeat Track (non-PBC Video CDs only)
-  Repeat All Tracks (non-PBC Video CDs only)
-  Repeat A-B
-  Repeat Off
-  Resume play from this point
-  Action prohibited or not available

Notes

- Some discs may not provide all of the features on the on-screen display example shown below.
- If no button is pressed for 10 seconds, the on-screen display disappears.

Items		Function (Press ▲▼ to select desired item)	Selection Method
Title Number	 1 / 3	Shows the current title number and total number of titles, and skips to the desired title number.	◀ / ▶, or Numbers, ENTER
Chapter Number		Shows the current chapter number and total number of chapters, and skips to the desired chapter number.	◀ / ▶, or Numbers, ENTER
Time search	 0:20:09	Shows the elapsed playing time, and searches the point directly from the elapsed time.	Numbers, ENTER
Audio language and Digital Audio Output mode	 1 ENG □□□ 5.1 CH	Shows the current audio soundtrack language, encoding method, and channel number, and changes the setting.	◀ / ▶, or AUDIO
Subtitle language		Shows the current subtitles language, and changes the setting.	◀ / ▶, or SUBTITLE
Angle	 1 / 1	Shows the current angle number and total number of angles, and changes the angle number.	◀ / ▶, or ANGLE
Sound	 BYPASS	Shows the current sound mode, and changes the setting.	◀ / ▶, or SOUND MODE

Items		Function (Press ▲▼ to select desired item)	Selection Method
Track Number	 1 / 4	Shows the current track number, total number of tracks and PBC On mode, and skips to the desired track number.	◀ / ▶, or Numbers, ENTER
Time	 0:20:09	Shows the elapsed playing time (Display only)	-
Audio Channel	 STER.	Shows the audio channel, and changes the audio channel.	◀ / ▶, or AUDIO
Sound	 BYPASS	Shows the current sound mode, and changes the setting.	◀ / ▶, or SOUND MODE



Before Operation - DVD part (Continued)

Initial Settings

You can set your own Personal Preferences on the DVD/CD/VCR receiver.

General Operation

- 1** Press **SETUP**.
The setup menu appears.

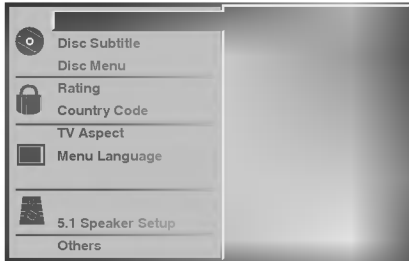

- 2** Press **▲▼** to select the desired item.
The screen will show the current setting for the selected item, as well as alternate setting(s).

- 3** While the desired item is selected, press **▶**, then **▲▼** to select the desired setting.

- 4** Press **ENTER** to confirm your selection.
Some items require additional steps.

- 5** Press **SETUP**, **RETURN**, or **PLAY** to exit the setup menu.

Language

Disc Language

Select a language for the disc's Menu, Audio, and Subtitle.

Original : The original language set for the disc is selected.
Other : To select another language, press number buttons to enter the corresponding 4-digit number according to the language code list on page 41. If you enter the wrong language code, press **CLEAR**.

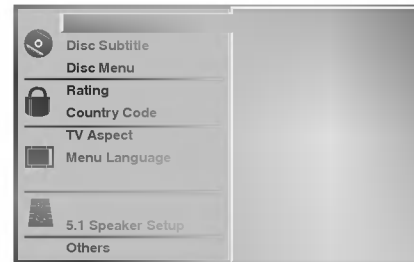

Menu Language

Select a language for the setup menu. This is the menu you see when you press **SETUP**.

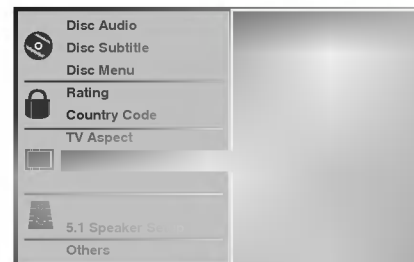

Picture

TV Aspect

4:3 Letterbox: Select when a standard 4:3 TV is connected. Displays theatrical images with masking bars above and below the picture.

4:3 Panscan: Select when a conventional TV set is connected. The video material formatted in the Pan & Scan style is played back in that style (Both sides of the picture are cut off).

16:9 Wide: Select when a 16:9 wide TV is connected.

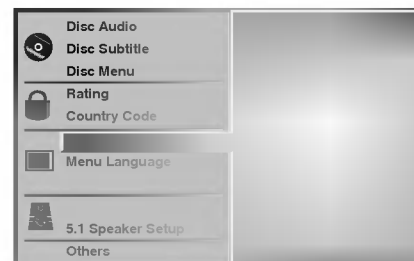

Before Operation - DVD part (Continued)

Speaker setup

5.1 Speaker settings

Select speaker settings, including volume balance and delay time, or test the speaker settings.

Speaker settings are only active on the Analog Multi-Channel Output. (See "Speaker Setup", page 35.)



Others

The DRC, Vocal, PBC and Auto Play settings can be changed.

- Press ▲/▼ to select the desired item and press ENTER. The setting of the selected item is changed between On and Off.

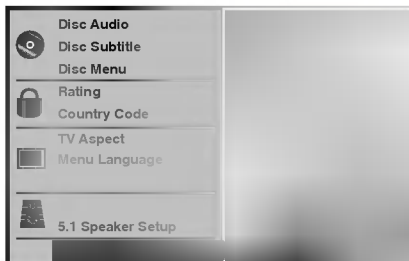

Dynamic Range Control (DRC)

With the DVD format, you can hear a program's soundtrack in the most accurate and realistic presentation possible, thanks to digital audio technology. However, you may wish to compress the dynamic range of the audio output (the difference between the loudest sounds and the quietest ones). Then, you may listen to a movie at a lower volume without losing clarity of sound. Set DRC to On for this effect.

Vocal

Set Vocal to On only when a multi-channel karaoke DVD is playing. The karaoke channels on the disc will mix into normal stereo sound.

PBC

Set Playback Control (PBC) to On or Off.

- On:** Video CDs with PBC are played according to the PBC.
- Off:** Video CDs with PBC are played the same way as Audio CDs.

Auto Play

You can set up the DVD/CD/VCR receiver so a DVD disc automatically starts playing whenever the DVD is inserted.

If Auto Play mode is set to On, this DVD/CD/VCR receiver will search a title that playback time is longest and then play back the title automatically.

On: Auto Play function is activated.

Off: Auto Play function is not activated.

Note

The Auto Play function may not work for some DVDs.



Before Operation - DVD part (Continued)

Parental Control

Rating

Movies on DVDs may contain scenes not suitable for children. Therefore, discs may contain Parental Control information that applies to the complete disc or to certain scenes on the disc. These scenes are rated from 1 to 8, and alternatively, more suitable scenes are available for selection on some discs. Ratings are country-dependent. The Parental Control feature allows you to prevent discs from being played by your children or to have certain discs played with alternative scenes.



1 Select "Rating" on the Setup menu using the ▲▼ buttons.

2 While "Rating" is selected, press ►.

3 When you have not entered a password. Enter a 4-digit password using the number buttons to create a personal 4-digit security password. then press ENTER. Enter the 4-digit password again and press ENTER to verify.

When you have already registered a password; Enter a 4-digit password using the numbered buttons to confirm the personal 4-digit security password, then press ENTER.

If you make a mistake before pressing ENTER, press CLEAR and enter 4-digit security password again.

4 Select a rating from 1 to 8 using the ▲▼ buttons. One (1) has the least playback restrictions. Eight (8) has the most playback restrictions.

Unlock: If you select Unlock, Parental Control is not active. The disc will play in full.

Ratings 1 to 8: Some discs contain scenes not suitable for children. If you set a rating for the player, all disc scenes with the same rating or lower will be played. Higher rated scenes will not be played unless an alternative scene is available on the disc. The alternative must have the same rating or a lower one. If no suitable alternative is found, playback will stop. You must enter the 4-digit password or change the rating level in order to play the disc.

5 Press ENTER to confirm your rating selection, then press SETUP to exit the menu.

Note

This function may not work for some DVDs.

Country Code

Enter the code of a country/area whose standards were used to rate the DVD video disc, referring to the list (See "Country Code List", page 42).

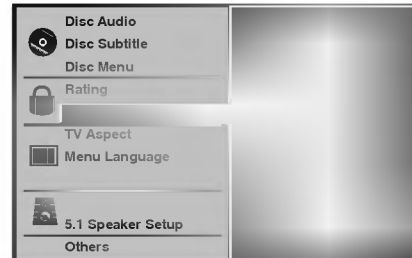

1 Select Country Code using the ▲▼ buttons on the setup menu.

2 While Country Code is selected, press ►.

3 Follow step 3 of "Rating" on left.

4 Select the first character using the ▲▼ buttons.

5 Shift the cursor using ► button and select the second character using ▲▼ buttons.

6 Press ENTER to confirm your country code selection, then press SETUP to exit the menu.

Note

Confirmation of the 4-digit password is necessary when the code is changed (see "Changing the 4-digit code" below.).

Changing the 4-digit code

1 Follow Steps 1-2 as shown above to the left (Rating).

2 Enter the old code, then press ENTER.

3 Select Change using ▲▼ buttons then press ENTER.

4 Enter the new 4-digit code, then press ENTER.

5 Enter exactly the same code a second time and verify by pressing ENTER.

6 Press SETUP to exit the menu.

If you forget your 4-digit code

If you forget your password, to clear the current password, follow the procedure below.(in the NO DISC mode.)

1 Press SETUP to display the setup menu.

2 Use the Number buttons to enter the 6-digit number "210499".

The 4-digit password is cleared.

3 Enter a new code as shown above to the left (Rating).

Operation with tape

Playing a tape

You will only be able to load and eject video cassettes when your DVD/CD/VCR receiver is plugged into the mains.

Your DVD/CD/VCR receiver may also play back recordings from NTSC tapes (on PAL TV).

Getting a better picture

When a cassette is inserted and playback started, the automatic tracking function works to get the best possible picture automatically. If the quality of the recording is poor, repeatedly press either **PR/TRK** (▲▼) on the remote control or **PROG/TUNING** (▲▼) on the front panel to manually adjust the tracking until any distortions have been removed. Press numbered button **0** on the remote control to switch automatic tracking back on again.

1 Make sure that you have correctly connected your DVD/CD/VCR receiver as described earlier in this book.

Turn on your TV.

Press **POWER** to turn on your DVD/CD/VCR receiver.

Insert the video cassette into your DVD/CD/VCR receiver.

The video cassette should have the window side facing up and the arrow facing away from you.

2 Press **PLAY** (▶) to start playing your tape.

If you load a video cassette which has had its record protection tab removed, playback of the cassette will start automatically.

AUTO TRACKING

Your DVD/CD/VCR receiver will automatically adjust the tracking to give the best picture quality.

3 Press **PAUSE/STEP** (⏸) to still a picture. Press **PAUSE/STEP** (⏸) repeatedly to advance the tape frame by frame.

If you press **FORWARD**, the picture will be slowed down at about 1/19 times the normal playback.

Tapes can be paused for up to 5 minutes. After 5 minutes your receiver will stop the tape to prevent from damage to the tape or your receiver.

Still picture quality can be improved slightly by pressing **PR/TRK** (▲▼) on the remote control.

4 Press **PLAY** (▶) to continue playing your tape.

Picture search:

During playback press either **FORWARD** or **BACKWARD**. This will enable you to rapidly wind the tape (7 times normal playback) while seeing where you are on the tape.

Logic search:

During fast forward or rewind press and hold **FORWARD** or **BACKWARD**. The picture will be played back at 7 times normal playback speed.

5 During playback or still picture press ◀ or ▶. You can reach the following playback speeds.

(-7xplay, -3xplay, -play, still, 1/19 slow, play, 2xplay, 7xplay)

To switch off the slow motion and shuttle, press the desired function.

During slow motion and shuttle, the noise bars may appear on the picture according to the status of tape.

If distortions can be seen in the picture, reduce them with **PR/TRK** (▲▼) on the remote control.

6 Press **STOP** (■) to end playback. Press **EJECT**.

If the end of the tape is reached, your DVD/CD/VCR receiver will stop playback automatically, rewind, stop at the top of the tape, eject the tape then power off.

CM (Commercial Message) Skip:

When playing back tapes, this feature lets you skip through commercial breaks by fast-forwarding, and then resume normal playback.

While tape is playing press **CM SKIP** on the remote control to skip commercial (or other programme material).

Repeatedly press **CM SKIP** to skip:

The tape will fast forward picture search through 30 seconds of recording for each press of the button.

1 Press	30 seconds
2 Presses	60 seconds
3 Presses	90 seconds
4 Presses	120 seconds
5 Presses	150 seconds
6 Presses	180 seconds

OPR (Optimum Picture Response):

This feature automatically improves playback picture quality by adjusting your DVD/CD/VCR receiver to the condition of the tape.

1 Press **i**.

2 Press ◀ or ▶ to select OPR and press **OK**.

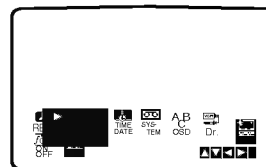

3 Press ▲ or ▼ repeatedly to select: **OFF**, **SOFT** or **SHARP**.

Please note you may set OPR only when playing back a tape.

4 Press **i** to remove the menus from the TV screen.

Operation with tape

The DVD/CD/VCR receiver allows you to make recordings using a variety of simple methods:

Instant Timer Recording (ITR): Starts recording immediately for a set period of time or until the video cassette runs out.

Timer Recording: You may record at a later time (up to 1 month from the present). Up to 7 of these automatic recordings may be set.

The DVD/CD/VCR receiver incorporates Long Play (LP) which enables you to record up to twice the amount of time on a video cassette. For example an E-180 will record up to 180 minutes using Standard Play (SP); using LP you will be able to record up to 360 minutes. Please note there will be a slight loss in picture and sound quality when using LP.

Instant Timer Recording (ITR)

1 Make sure that you have correctly connected your DVD/CD/VCR receiver as described earlier in this book.

Press **POWER** to turn on your DVD/CD/VCR receiver.

2 Insert a video cassette with protection tab into your DVD/CD/VCR receiver.

The video cassette should have the window side facing up and the arrow facing away from you.

3 Press **PR/TRK** (▲▼) to select the programme number you wish to record.

You may also directly select programme numbers using the **numerical buttons** on the remote control.

4 If you wish to record directly from either of the SCART sockets or AV3 sockets, repeatedly press **AV** until the socket you wish to record from is displayed.

AV 1 for recording from EURO AV1 socket on the rear of your DVD/CD/VCR receiver.

AV 2 for recording from EURO AV2 socket on the rear of your DVD/CD/VCR receiver.

AV 3 for recording from AV3 sockets on the front of your DVD/CD/VCR receiver.

5 Press **SPEED** if you wish to record in Long Play or Standard Play.

SP will produce improved picture and sound quality, however LP will provide twice as much recording time as SP.

6 Press **REC/ITR** (●) to start recording.

RECORD will appear on the TV screen.

Press **REC/ITR** several times. Each successive press will increase the record time by 30 minutes until you reach a maximum of 9 hours.

7 Press **PAUSE/STEP** (||) to avoid recording unwanted scenes.

Press **PAUSE/STEP** (||) to continue recording.

If you press **PAUSE/STEP** (||) during ITR, the DVD/CD/VCR receiver will enter the record pause mode and ITR is cancelled.

Tapes can be paused for up to 5 minutes; RECP will be displayed when a tape is paused. After 5 minutes your DVD/CD/VCR receiver will stop recording to prevent damaging the tape or your DVD/CD/VCR receiver.

8 Press **STOP** (■) twice within 5 seconds to end recording. Press **EJECT** (▲).

EJECT will appear on the TV screen for a few seconds.

Notes

- If you do not wish to record on a tape (this can happen quite easily by accident!) remove the protection tab on the back edge of the video cassette.
- It is possible to record on a video cassette with the record protection tab removed by covering the hole with self adhesive tape.
- Remember you can record one programme while watching another by starting your instant recording, pressing **TV/VCR** to appear **TV** indicator in the display window and then selecting a different channel on your TV.

Operation with tape

Timer recording using On Screen

Display

You may set up to seven timer record events within one month of the current date.

PLEASE NOTE! before setting the timer make sure that you have set the DVD/CD/VCR receiver clock correctly and you know which channels on your DVD/CD/VCR receiver you have tuned to TV stations.

In a stage 4, if you want to record from either of the SCART sockets or AV3 on the front, press **AV**.

1 Insert a video cassette with protection tab into your DVD/CD/VCR receiver.

The video cassette should have the window side facing up and the arrow facing away from you.

2 Press i.

Press **◀** or **▶** to select REC and press **OK**.

If all timer record events are full press **▲** or **▼** to select the event that you wish to remove and replace.

Press **◀** to delete the event.

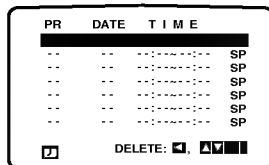

3 Press OK to start setting the timer record event.

4 Press the numerical buttons to enter the station that you wish to record.

When selecting stations 1 - 9, press 0 first, then the channel number; for example Stations 3 - 03. You may also select Channels by pressing **▲** or **▼**.

If you want to record from either of the SCART sockets or AV INPUT on the front, repeatedly press **AV** for the correct display (AV1, AV2 or AV3).

Once selected press **▶**.

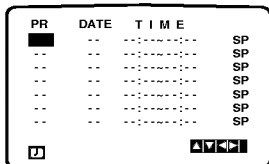

5 Press the numerical buttons to enter the date of the programme.

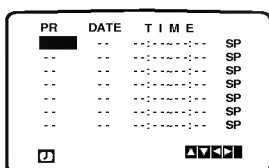

If you press **OK** before entering the date you may select one of the following automated recording features. Press **◀** or **▶** to select, then press **OK** to confirm.

DLY To record every day (except Saturday and Sunday) at the same time.

Weekly To record at the same time every week.

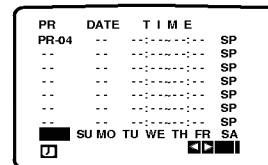

6 Press the numerical buttons to enter the recording start and end times of the programme that you wish to record.

Please note your DVD/CD/VCR receiver uses a 24-hour clock. e.g. 1pm will be displayed as 13:00. You may also select the start and end times by pressing **▲** or **▼**.

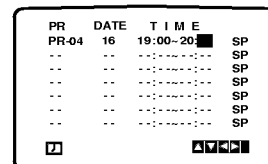

7 Press ▶ to select the recording speed and press ▲ or ▼ if you wish to record in IP or LP.

Intelligent LP Recording

When you set the tape speed to "IP", the DVD/CD/VCR receiver automatically switches to LP mode to allow complete recording if there is not enough tape to record the entire programme while timer-recording in SP mode.

8 Check that the timer event details are correct. Press i to save your settings.

If **PLEASE CHECK** is displayed, you have entered data incorrectly and will need to re-enter the data.

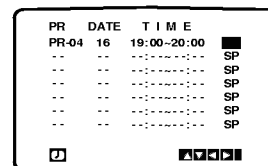

9 Press i to remove the menus.

If you want to make other timer recordings repeat stages 2 - 8.

10 Press POWER to switch your DVD/CD/VCR receiver to Standby.

Ⓞ will appear in the DVD/CD/VCR receiver's display while your DVD/CD/VCR receiver waits to make the recording.

If the DVD/CD/VCR receiver is DVD mode, even with the DVD/CD/VCR receiver is power on, it will record any timer programme.

To stop the timer recording, press **POWER** twice.

Operation with tape

If Timer record events Overlap...

Do not overlap programmes, since overlapping portions of the conflicting programmes will not be recorded. Earlier recording times have priority over later recording times as shown in the diagram.

Example:

Programme 1 will be recorded in its entirety, but only the last 30 minutes of Programme 2 will be recorded.

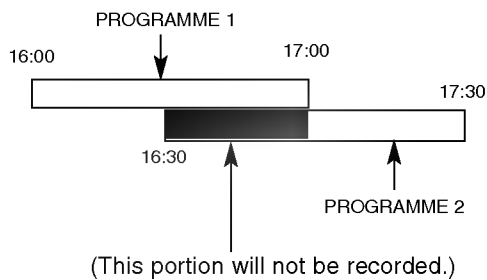

If two programmed timer recordings overlap at midnight 00:00 a.m., programme 2 will not be recorded.

Change (Deleting) the Timer Programme

If at a later date you wish to **delete** or **change** any of the settings in timer event memory you may do so without having to enter all the timer event information again. Simply display the timer event screen. Press ▲ or ▼ to select the event that you wish to **delete** or **change**. Press ◀ to delete the event...or Press **OK** to change, then press ◀ or ▶ to select; Station, Date, Start and End times and LP. Press ▲ or ▼ to enter the correct information.

Operation with DVD and Video CD

Playing a DVD and Video CD

Playback Setup

- Turn on the TV and select the video input source connected to the DVD/CD/VCR receiver.
- Audio system: Turn on the audio system and select the input source connected to the DVD/CD/VCR receiver.

1 Press OPEN/CLOSE to open the disc tray.

2 Load your chosen disc in the tray, with the playback side facing down.

3 Press OPEN/CLOSE to close the tray. READING appears on the TV screen, and playback starts automatically. If playback does not start, press PLAY.

In some cases, the disc menu might appear instead.

If a menu screen is displayed

The menu screen may be displayed first after loading a DVD or Video CD which offers a menu.



Use the ◀▶▲▼ buttons to select the title/chapter you want to view, then press ENTER to start playback. Press TITLE or DISC MENU to return to the menu screen.



- Use the number buttons to select the track you want to view.
Press RETURN to return to the menu screen.
- Menu setting and the exact operating procedures for using the menu may differ depending on the disc. Follow the instructions on the each menu screen. You also may set PBC to Off under setup. See page 22.

Notes

- If Parental Control is set and the disc is not within the Rating settings (not authorized), the 4-digit code must be entered and/or the disc must be authorized (see "Parental Control", on page 23).
- DVDs may have a region code.
Your DVD/CD/VCR receiver will not play discs that have a regional code different from your receiver. The regional code for this receiver is 3 (three).

General Features

Note

Unless stated otherwise, all operations described use the remote control. Some features may also be available on the Setup menu.

Moving to another TITLE



When a disc has more than one title, you can move to another title as follows:

- Press DISPLAY, then press the appropriate number button (0-9) to select a title number.
- Press ◀▶ to select a title, then press ENTER.

Moving to another CHAPTER/TRACK



When a title on a disc has more than one chapter or a disc has more than one track, you can move to another chapter/track as follows:

- Press ◀◀ or ▶▶ briefly during playback to return to the beginning of the current chapter/track or to select the next chapter/track.
- Press ◀◀ twice briefly to step back to the previous chapter/track.
- To go directly to any chapter during DVD playback, press DISPLAY. Then, press ▲▼ to select the chapter/track icon. Then, enter the chapter/track number using the numbered buttons (0-9) or press ◀▶ to select the chapter/track, then press ENTER.

Notes

- For two-digit numbers, press the numbered buttons (0-9) in rapid succession.
- On a Video CD with PBC, you must set PBC to Off on the setup menu to use the Repeat function. See page 22.

Search

- 1 Press and hold ◀◀ or ▶▶ for about two seconds during playback.
The receiver will now go into SEARCH mode.
- 2 Press and hold ◀◀ or ▶▶ repeatedly to select the required speed: ◀◀X2, ◀◀X4, ◀◀X16, ◀◀X100 (backward) or ▶▶X2, ▶▶X4, ▶▶X16, ▶▶X100 (forward).
With a Video CD, the Search speed changes: ◀◀X2, ◀◀X4, ◀◀X8, (backward) or ▶▶X2, ▶▶X4, ▶▶X8, (forward).
- 3 To return to normal play, press PLAY.



Operation with DVD and Video CD

General Features (continued)

Still Picture and Frame-by-Frame Playback

- 1 Press PAUSE/STEP during playback.
The DVD/CD/VCR receiver will now go into PAUSE mode.
- 2 You can advance the picture frame-by-frame by pressing PAUSE/STEP repeatedly on the remote control.
- 3 To return to normal play, press PLAY.

Slow Motion

- 1 Press PAUSE/STEP (||) during playback.
The DVD/CD/VCR receiver will now go into PAUSE mode.
- 2 Press BACKWARD (◀◀) or FORWARD (▶▶) during pause mode.
The DVD/CD/VCR receiver will enter SLOW mode.
- 3 Use BACKWARD (◀◀) or FORWARD (▶▶) to select the required speed: ◀◀ 1/16, ◀◀ 1/8, ◀◀ 1/4, ◀◀ 1/2 (backward), or ▶▶ 1/16, ▶▶ 1/8, ▶▶ 1/4, ▶▶ 1/2 (forward).
- 4 To return to playback, press PLAY (▶).

Note

Slow motion playback in reverse is not applicable for Video CD.

Repeat



DVD Video Discs - Repeat Chapter/Title/Off

- 1 To repeat the currently playing chapter, press REPEAT.
The Repeat Chapter icon appears on the TV screen.
- 2 To repeat the title currently playing, press REPEAT a second time.
The Repeat Title icon appears on the TV screen.
- 3 To exit Repeat mode, press REPEAT a third time.
The Repeat Off icon appears on the TV screen.

Video CDs - Repeat Track/All/Off

- 1 To repeat the track currently playing, press REPEAT.
The Repeat Track icon appears on the TV screen.
- 2 To repeat the disc currently playing, press REPEAT a second time.
The Repeat All icon appears on the TV screen.
- 3 To exit Repeat mode, press REPEAT a third time.
The Repeat Off icon appears on the TV screen.

Note

On a Video CD with PBC, you must set PBC to Off on the setup menu to use the Repeat function. See page 22.

Repeat A-B



To repeat a sequence in a title:

- 1 Press REPEAT A-B at your chosen starting point.
“A*” appears briefly on the TV screen.
- 2 Press REPEAT A-B again at your chosen end point.
“A B” appears briefly on the TV screen, and the repeat sequence begins (“A↔B” appears the display window).
- 3 To cancel the sequence, press REPEAT A-B.

Time Search



The Time Search function allows you to start playing at any chosen time on the disc.

- 1 Press DISPLAY during playback. The on-screen display appears on the screen.
The Time Search box shows the elapsed playing time of the current disc.
- 2 Within 10 seconds, press ▲/▼ to select the Time Search icon in the on-screen display.
The “-:--:--” appears in the Time Search box.
- 3 Within 10 seconds, use the number buttons to enter the required start time. Enter hours, minutes, and seconds from left to right in the box.
If you enter the wrong numbers, press CLEAR to remove the numbers you entered. Then enter the correct numbers.
- 4 Within 10 seconds, press ENTER or press PLAY to confirm the start time.
Playback starts from the selected time on the disc. If you enter an invalid time, playback will continue from the current point.

3D Surround



This unit can produce a 3D Surround effect, which simulates multi-channel audio playback from two conventional stereo speakers, instead of the five or more speakers normally required to listen to multi-channel audio from a home theater system.

- 1 Press SOUND MODE to select “3D SUR” during playback.
- 2 To turn off the 3D Surround effect, press SOUND MODE again to select “BYPASS”.

Operation with DVD and Video CD

General Features (continued)

Zoom

The Zoom function allows you to enlarge the video image and to move through the enlarged image.

- 1 Press ZOOM during playback or still playback to activate the Zoom function.
If you press ZOOM repeatedly, the magnification level increases up to six steps.
- 2 Use the ◀▶▲▼ buttons to move through the zoomed picture.
- 3 Press CLEAR to resume normal playback or return to the paused image.

Note

- The Zoom function may not work for some DVDs.

Marker Search



You can start playback from a memorized point. Up to nine points can be memorized. To enter a mark, follow these steps.

- 1 During disc playback, press MARKER when playback reaches the spot that you want to memorize.
The Marker icon will appear on the TV screen briefly.
- 2 Repeat step 1 to enter up to nine Marker points on a disc.

To Recall a Marked Scene

- 1 During disc playback, press SEARCH.
The MARKER SEARCH menu will appear on the screen.
- 2 Within 10 seconds, press ◀▶ or use the number buttons to select a Marker number that you want to recall.
- 3 Press ENTER.
Playback will start from the Marked scene.
- 4 To remove the MARKER SEARCH menu, press SEARCH.

To clear a Marked Scene

- 1 During disc playback, press SEARCH.
The MARKER SEARCH menu will appear on the screen.
- 2 Press ◀▶ to select the Marker number that you want to erase.
- 3 Press CLEAR.
The Marker number will be erased from the list.
- 4 Repeat steps 2 and 3 to erase additional Marker numbers.
- 5 To remove the MARKER SEARCH menu, press SEARCH.

Special DVD Features

Checking the contents of DVD Video discs: Menus

DVDs may offer menus that allow you to access special features. To use the disc menu, press MENU. Then, press the appropriate number button to select an option. Or, use the ◀▶▲▼ buttons to highlight your selection, then press ENTER.

Title Menu

- 1 Press TITLE.
If the current title has a menu, the menu will appear on the screen. Otherwise, the disc menu may appear.
- 2 The menu can list camera angles, spoken language and subtitle options, and chapters for the title.
- 3 To remove the title menu, press TITLE again.

Disc Menu

- 1 Press DISC MENU.
The disc menu is displayed.
- 2 To remove the disc menu or to return to play, press DISC MENU again.

Camera Angle



If the disc contains scenes recorded at different camera angles, you can change to a different camera angle during playback.

- Press ANGLE repeatedly during playback to select a desired angle.
The number of the current angle appears on the TV screen.

Changing the Audio Language



Press AUDIO repeatedly during playback to hear a different audio language or audio track.

Changing the Audio Channel

Press AUDIO repeatedly during playback to hear a different audio channel (STER., LEFT or RIGHT).

Subtitles



Press SUBTITLE repeatedly during playback to see the different subtitle languages.

Note

If ⊘ appears, the feature is not available on the disc.



Operation with Audio CD and MP3/WMA Disc

Playing an Audio CD and MP3/WMA Discs

The DVD/CD/VCR receiver can play MP3/WMA formatted recordings on CD-ROM, CD-R or CD-RW discs. Before playing MP3/WMA recordings, read the notes on MP3 Recordings on right.

1 Insert a disc and close the tray.

Audio CD; Audio CD menu appears on the TV screen go to step 4.

MP3/WMA disc; The MP3/WMA-JPEG choice menu appears on the TV screen. Go to step 2



2 Press ▲▼ to select the MP3/WMA then press ENTER or PLAY.

The MP3/WMA menu appears on the TV screen. Press RETURN to move to the MP3/WMA-JPEG choice menu.

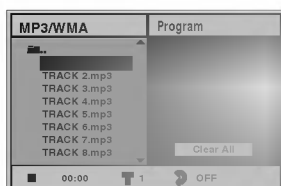

3 Press ▲▼ to select a folder, and ENTER or PLAY.

A list of files in the folder appears.

4 Press ▲▼ to select a track then press PLAY or ENTER.

Playback starts.

During playback, the current track's elapsed playing time will appear on the display window and menu.

Playback will stop at the end of the disc.

Press TITLE to move to the next page.

Press DISC MENU to move to the previous page.

Audio CD menu

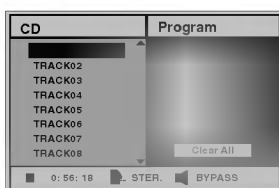

MP3/WMA menu

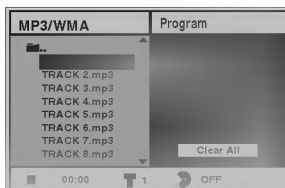

If you are in a file list and want to return to the Folder list, use the ▲▼ to highlight ■-- and press ENTER to return to the previous menu screen.

5 To stop playback at any other time, press STOP.

Notes on MP3/WMA Recordings

About MP3

- An MP3 file is audio data compressed by using the MPEG1 audio layer-3 file-coding scheme. We call files that have the ".mp3" file extension "MP3 files".
- The player can not read an MP3 file that has a file extension other than ".mp3".

About WMA(Window Media Audio)

- An WMA file is a Microsoft audio compression technology.
- WMA(Windows Media Audio) offers double the audio compression of the MP3 format.

MP3/WMA Disc compatibility with this DVD/CD receiver is limited as follows:

1. Sampling Frequency / only at 44.1kHz (MP3), 22.05 - 44.1kHz (WMA)
2. Bit rate / within 32 - 320kbps (MP3), 32 - 128kbps (WMA)
3. CD-R physical format should be "ISO 9660"
4. If you record MP3/WMA files using the software which cannot create a FILE SYSTEM, for example "Direct-CD" etc., it is impossible to playback MP3/WMA files. We recommend that you use "Easy-CD Creator", which creates an ISO9660 file system.
5. A single session disc requires MP3/WMA files in the first track. If there is no MP3/WMA file in the 1st track, it cannot playback MP3/WMA files. If you wish to playback MP3/WMA files, format all the data in the disc or use a new one.
6. File names should be named using 8 letters or less and must incorporate ".mp3" or ".wma" extension e.g. "*****.MP3" or "*****.WMA".
7. Do not use special letters such as "/ : * ? < > " etc.
8. Total number of files on the disc should be less than 650.

This DVD/CD/VCR receiver requires discs/recordings to meet certain technical standards in order to achieve optimal playback quality. Pre-recorded DVDs are automatically set to these standards. There are many different types of recordable disc formats (including CD-R containing MP3 or WMA files). That require certain pre-existing conditions (see above) to insure compatible playback.

Customers should also note that permission is required in order to download MP3/WMA files and music from the Internet. Our company has no right to grant such permission. Permission should always be sought from the copyright owner.





Operation with Audio and MP3/WMA Disc (Continued)

Pause

- 1 Press PAUSE/STEP during playback.
- 2 To return to playback, press PLAY, PAUSE/STEP or ENTER again.











Moving to another Track

- Press  or  briefly during playback to return to the beginning of the current track or to go to the next track.
- Press  twice briefly to step back to the previous track.
- In case of audio CD, to go directly to any track, enter the track number using the numbered buttons (0-9) during playback.

Repeat Track/All/Off

- 1 To repeat the track currently playing, press REPEAT. The Repeat icon and "TRACK" appears on the menu screen.
- 2 To repeat all tracks on a disc, press REPEAT a second time. The Repeat icon and "ALL" appears on the menu screen.
- 3 To cancel Repeat mode, press REPEAT a third time. The Repeat icon and "OFF" appears on the menu screen.

Search

- 1 Press and hold  or  for about two seconds during playback. The player will now go into SEARCH mode.
- 2 Press and hold  or  repeatedly to select the required speed: X2, X4, X8 (backward) or X2, X4, X8 (forward). Search speed and direction are indicated on the menu screen.
- 3 To return to playback, press PLAY.

Repeat A-B

To repeat a sequence.

- 1 During disc playback, press REPEAT A-B at your chosen starting point. The Repeat icon and "A*" appears on the menu screen.
- 2 Press A-B again at your chosen end point. The Repeat icon and "A B" appears on the menu screen, and the sequence begins to play repeatedly.
- 3 To exit the sequence and return to normal play, press A-B again. The Repeat icon and "OFF" appears on the menu screen.

3D Surround

This unit can produce a 3D Surround effect, which simulates multi-channel audio playback from two conventional stereo speakers, instead of the five or more speakers normally required to listen to multi-channel audio from a home theater system.

- 1 Press SOUND MODE to select "3D SUR" during playback.
- 2 To turn off the 3D Surround effect, press SOUND MODE again to select "BYPASS".

Changing the Audio Channel

Press AUDIO repeatedly during playback to hear a different audio channel (STER., LEFT, or RIGHT).



Operation with JPEG Disc

Viewing a JPEG disc

This DVD/CD/VCR receiver can play discs with JPEG files and Kodak picture CD. Before playing JPEG recordings, read the notes on JPEG Recordings on right.

1 Insert a disc and close the tray.

The MP3/WMA-JPEG choice menu appears on the TV screen.



2 Press ▲▼ to select the JPEG then press ENTER.

The JPEG menu appears on the TV screen.



3 Press ▲▼ to select a folder, and press ENTER or PLAY.

A list of files in the folder appears.
Press RETURN to move to the MP3/WMA-JPEG choice menu.



If you are in a file list and want to return to the Folder list, use the ▲▼ buttons on the remote to highlight "▲▼" and press ENTER to return to the previous menu screen.

4 If you want to view a particular file, press ▲▼ to highlight a file and press ENTER or PLAY.

Viewing the file proceeding starts.
During viewing a file, press RETURN to move to the previous menu (JPEG menu).
Press TITLE to move to the next page.
Press MENU to move to the previous page.



There are three viewing Slide Speed options: Fast, Normal, Slow, and Off. Press ◀▶ to highlight the Slide Speed then press ▲▼ to select the option you want to use, and press ENTER.

5 To stop viewing at any other time, press STOP.

The JPEG menu appears.

Moving to another File

Press ◀◀ or ▶▶ once while viewing a picture to advance to the next file or to the previous file.

Still Picture

- 1 Press PAUSE/STEP during slide show.
The DVD/CD/VCR receiver will now go into PAUSE mode.
- 2 To return to the slide show, press PLAY or press PAUSE/STEP again.

To flip the picture

Press ▲▼ while showing a picture to flip the picture horizontally or vertically.

To rotate picture

Press ◀▶ during showing a picture to rotate the picture clockwise or counterclockwise.

Notes on JPEG Recordings

- Depending upon the size and number of the JPEG files, it could take a long time for the DVD/CD/VCR receiver to read the disc's contents. If you don't see an on-screen display after several minutes, some of the files are too big — reduce the resolution of the JPEG files to less than 2 mega pixels and burn another disc.
- Total number of files and folders on the disc should be less than 650.
- Some disc may be incompatible due to different recording format or condition of disc.
- When you are using software such as "Easy CD Creator" to burn the jpeg files into the CD-R, ensure that all the selected files have the ".jpg" extensions when copying into the CD layout.
- If the files have ".jpe" or ".jpeg" extensions, please rename them as ".jpg" files.
- File names without ".jpg" extension will not be able to be read by this DVD/CD/VCR receiver. Even though the files are shown as JPEG image files in windows explorer.

Programmed Playback

Programmed Playback with Audio CD and MP3/WMA Discs

The Program function enables you to store your favourite tracks from any disc in the player memory.

Program can contain 30 tracks.

1 Press PROGRAM during playback or in the stop mode to enter the Program Edit mode.

The  mark will appear to the right of the word Program on the right side of the menu screen.

Note

Press PROGRAM to exit the Program Edit mode; the  mark will disappear.

2 Select a track, then press ENTER to place the selected track on the Program list.

3 Repeat step 2 to place additional tracks on the Program list.

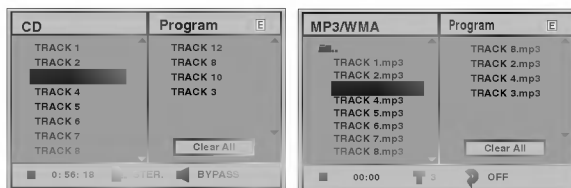

Audio CD menu

MP3/WMA menu

4 Press ►.

The programmed track you selected last is highlighted on the program list.

5 Press ▲▼ to select the track you want to start playing.

Press TITLE to move to the next page.

Press MENU to move to the previous page.

6 Press PLAY or ENTER to start.

Playback begins in the order in which you programmed the tracks and "PROG." appears on the menu screen. Playback stops after all of the tracks on the Program list have played once.

7 To resume normal playback from programmed playback, select a track of CD (or MP3/WMA) list and then press ENTER or PLAY.

"PROG." indicator disappears in the display window.

Programmed Playback with Video CD

Note

On a Video CD with PBC, you must set PBC to Off on the setup menu to use the Program function. See page 22.

Program can contain 30 tracks.

1 Insert Video CD and close the tray.

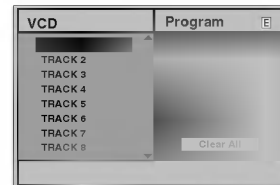

2 Press PROGRAM while playback is stopped.

The VCD Program menu will appear.

Note

Press RETURN, PROGRAM or PLAY to exit the Program menu.

3 Follow steps 2-6 of "Programmed Playback with Audio CD and MP3/WMA disc" on left.

4 To resume normal playback from programmed playback, press PROGRAM.

"PROG." indicator disappears in the display window.

Repeat Programmed Tracks

- To repeat the track currently playing, press REPEAT. The Repeat icon and "TRACK" appears on the menu screen.
- To repeat all tracks on the program list, press REPEAT a second time. The Repeat icon and "ALL" appears on the menu screen.
- To cancel Repeat mode, press REPEAT a third time. The Repeat icon and "OFF" appears on the menu screen.

Erasing a Track from Programme List

- 1 Press PROGRAM during playback (Audio CD and MP3/WMA disc only) or stop to enter the Programme Edit mode.

The  mark will appear.

- 2 Press ► to move to the Programme list.
- 3 Use ▲▼ to select the track that you wish to erase from the Programme list.
- 4 Press CLEAR.
The track will be erased from the Program list.

Erasing the complete Programme List

- 1 Follow steps 1-2 of "Erasing a Track from Programme List" as above.
- 2 Use ▲▼ to select "Clear All", then press ENTER.
The complete Program for the disc will be erased.
The programmes are also cleared when the disc is removed.

Speaker Setup

Adjust the following settings for the built-in 5.1 channel surround decoder.

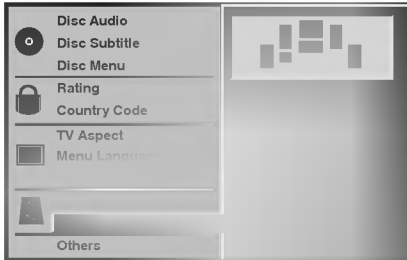

- 1** Select "5.1 Speaker Setup" using the ▲▼ buttons on the setup menu.
- 2** While "5.1 Speaker Setup" is selected, press ► button.
- 3** Press ► buttons to select the desired speaker.
- 4** Adjust options by using ▲▼◀▶ buttons.

Speaker selection

Select a speaker that you want to adjust. ((Front speakers (Left), Front speakers (Right), Centre Speaker, Rear speakers (Left), Rear speakers (Right), or Subwoofer))

Volume

Press ◀/▶ to adjust the output level of the selected speaker. (-6dB ~ +6dB)

Size

Since the speaker settings are fixed, you cannot change the settings.

Distance

If you connected speakers to your DVD/CD receiver, setting the Distance lets the speakers know how far the sound has to travel to reach your set listening point. This allows the sound from each speaker to reach the listener at the same time. (1 ft = 30.48 cm)

Note

You can not set the distance of subwoofer speaker.

Test

Press ENTER to test the signals of each speaker. Adjust the volume to match the volume of test signals memorized in the system.

- Front Left (L) → Centre → Front Right (R) → Rear Right (R) → Rear Left (L) → Subwoofer

Return

Press ENTER to return to the previous menu.

Additional Information

Last Condition Memory



This DVD/CD/VCR receiver memorizes the user settings for the last disc that you have viewed. Settings remain in memory even if you remove the disc from the player or switch off the player. If you load a disc that has its settings memorized, the latest stop position is automatically recalled.

Notes

- Settings are stored in memory for use any time.
- This player does not memorize settings of a disc if you switch off the DVD/CD/VCR receiver before commencing to play it.

Additional Operation - VCR part

On Screen Display

You may easily display the clock or tape counter and tape remaining, day, month, year, day of week, programme channel, tape speed and VCR function on the TV screen.

If a recording is taking place these On Screen Displays will not be recorded onto the tape.

1 Press CLK/CNT to display.

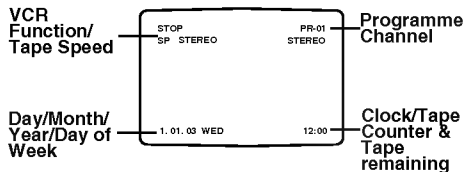

2 Press CLK/CNT repeatedly to display the tape counter.

During playback or recording, the tape remaining is displayed with the tape counter.

3 After 3 seconds the display will clear from the TV screen, leaving only the clock or tape counter and tape remaining on the TV screen. Press CLK/CNT again to remove all displays from the TV screen.

The tape remaining will only be accurate for E-180 and E-240 tapes.

The tape remaining indicator may not be accurate, since it depends on the type or condition of tape used. Also, the tape remaining indicator is not displayed just after a cassette has been inserted, or after playback or recording has begun.

Tape Counter Memory Stop

The **Digital Tape Counter** can be displayed on your TV screen instead of the time by pressing **CLK/CNT** on the remote control.

The Digital Tape Counter indicates the relative positions of recordings on the tape.

1 Press CLK/CNT repeatedly until the counter is displayed on the TV screen.

2 Press CLEAR to set the counter to 0:00:00. Press PLAY (▶) to start recording.

The tape counter will display the actual play time in hours, minutes and seconds.

3 Press STOP when playback or recording is complete.

4 Press BACKWARD.

The tape will rewind and automatically stop when the counter returns to 0:00:00.

Please note: If FORWARD is pressed when counter mode indicates a negative value, the tape will not stop.



Friendly User Guide (Video Doctor)

This feature informs you that there is a problem with your DVD/CD/VCR receiver. These error messages will appear on the TV screen.

1 Press i. Press ◀ or ▶ to select Dr. and press OK.

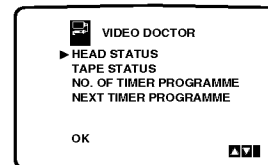

2 Press ▲ or ▼ to check a problem.

HEAD STATUS

- **PLEASE CLEAN:**
Clean your video heads.

TAPE STATUS

- **NOT RECORDABLE:**
Insert a tape with its protection tab in place

NO. OF TIMER PROGRAMME

- **2**
Shows the number of timer recording.

NEXT TIMER PROGRAMME

- **PR-01 26 10:00~11:00 SP**
Shows the current status of timer recording.

3 Press i to remove the menus from the TV screen.

ez (easy) Repeat

BY pressing & holding REPEAT during play back, the holding section is replayed twice automatically.

1 During play back, press & hold REPEAT at the point where repeat play is to be concluded. Then, your DVD/CD/VCR receiver will go into reverse search.

2 Release REPEAT at the point where repeat play is to start. Holding section is replayed twice automatically.

Note

Pressing REPEAT again during repeat play, the DVD/CD/VCR receiver will return to normal play.

Additional Operation - VCR part

Hi-Fi Stereo Sound System

Your DVD/CD/VCR receiver will record and play back Hi-Fi stereo sound. In addition it has a NICAM digital stereo sound decoder. This allows you to record and play back the sound in several different ways. Video cassettes recorded on your DVD/CD/VCR receiver will have a normal mono audio track and two VHS Hi-Fi stereo audio tracks. These stereo tracks allow you to make audio recordings in Hi-Fi stereo or bilingual mode from a TV broadcast, stereo audio system, video disc or another Hi-Fi VCR.

1 Your DVD/CD/VCR receiver's NICAM digital sound decoder allows you to enjoy broadcasts with NICAM sound, as well as standard stereo NICAM, bilingual and mono sound.

The particular type of sound received or that recorded will be briefly displayed on the TV screen for a couple of seconds:

STEREO

Sound is automatically recorded on the Hi-Fi stereo and mono tracks of the video tape.

BIL NICAM

Both audio channels will be recorded on the Hi-Fi stereo tracks. The primary language channel (left) will be recorded on the mono track of the video tape.

MONO

The sound is recorded on the Hi-Fi tracks and the mono track of the video tape without any separation.

2 Press **AUDIO** repeatedly until the desired audio mode appears.

The choice is **STEREO**, **LEFT** (left channel), **RIGHT** (right channel) and **MONO**.

In **BIL NICAM** playback the primary language is output on the left channel and the secondary language is output simultaneously from the right channel when audio output is set to **STEREO**.

The primary language will be output from both channels when the audio setting is **MONO**.

Please note that when adjusting the tracking control Hi-Fi stereo sound may revert to **MONO**.

3 Press **i** to return to a TV picture.



Note

If the quality of stereo sound being received is poor, the broadcast is automatically received in monaural with better quality.

Still, if the quality of the sound is poor, set **NIC** in the main menu to **OFF** (see p. 16). **NICAM** broadcasts will be detected.

Special Recording

Copying from DVD To VCR

This unit allows you to copy the contents of a DVD to a VHS tape.

Note

If the DVD you are attempting to copy is copy protected, you will not be able to copy the disc. It is not permitted to copy Macrovision encoded DVDs. "LOCK" will blink on the display window.

1 Insert Disc.

Insert the disc you wish to copy in the DVD deck and close the disc tray.

2 Insert VHS Tape.

Insert a blank VHS video tape into the VCR deck.

3 Press PLAY (▶) on the DVD deck.

The DVD will go into play mode

- If the DVD disc menu appears, you may need to press the PLAY (▶) manually to begin copying.

4 Press REC/ITR (●) or press COPY/MEMORY .

The VCR receiver will go into Record mode.

5 Stop the Copy Process.

When the DVD is finished playing, press STOP (■) twice within 5 seconds to end the copy.

You must stop the Copy process manually when the DVD movie ends, or the unit may replay and record over and over again.

Recording from another video

recorder

With the DVD/CD/VCR receiver you can make recordings from an external source, such as copying from another VCR or a camcorder.

Note

In the following description, this DVD/CD/VCR receiver will be one used for recording and other VCR will be used for playback.

1 VCR should be connected to the one of the SCART sockets on the rear panel of your DVD/CD/VCR receiver or the AV3 sockets on the front panel of your DVD/CD/VCR receiver.

2 Press AV until the socket you wish to record from is displayed.

AV1 Sound and Picture recording using the lower EURO AV1 socket on the back of your DVD/CD/VCR receiver.

AV2 Sound and Picture recording using the upper EURO AV2 socket on the back of your DVD/CD/VCR receiver.

AV3 Sound and Picture recording from **AV3** sockets on the front of your DVD/CD/VCR receiver.

3 Insert the recorded tape into VCR and a blank tape into DVD/CD/VCR receiver.

4 To start recording, press REC/ITR (●) on DVD/CD/VCR receiver and press PLAY on VCR.

5 When you want to finish copying, press the STOP (■) on both appliances.

Press STOP (■) twice within 5 seconds at DVD/CD/VCR receiver.



Radio Operation

Presetting the Radio Stations

You can preset 30 stations for FM and AM. Before tuning, make sure that you have turned down the volume.

- 1 Press FM/AM on the remote control or on the front panel until the frequency band appears on the display and TV screen.

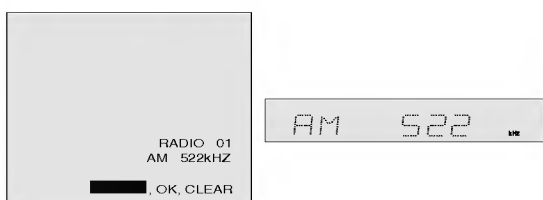

- 2 Press ▲▼ on the remote control to select your desired radio channel.

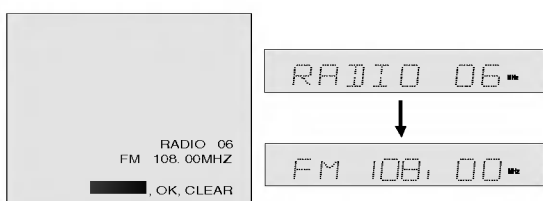

- 3 Press FM/AM on the remote control or on the front panel to select the desired band.
- 4 Hold down ▼ TUNING ▲ on the front panel or hold down ◀ and ▶ on the remote control for 1 or 2 seconds, and a station is searched for automatically.

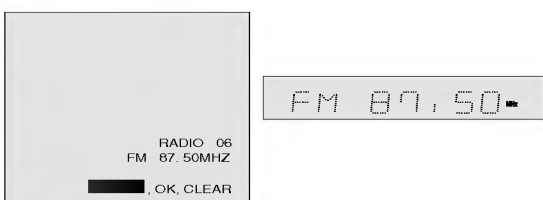

- 5 Press MEMORY on the remote control or press COPY/MEMORY on the front panel.



- 6 Repeat steps 2 to 5 to store other stations.

Listening to the Radio

Preset radio stations in the DVD/CD/VCR receiver memory first (see "Presetting radio stations" on the left).

- 1 Press FM/AM on the remote control or on the front panel until the frequency band appears on the display and TV screen.

The last received station is tuned in.

- 2 Press ▲▼ on the remote control repeatedly to select the preset station you want.

Each time you press the button, the DVD+Hi-Fi VCR tunes in one preset station at a time.

- 3 Adjust the volume by rotating VOLUME on the front panel or by pressing VOLUME + or - on the remote control repeatedly.

To Clear the Stored Radio Stations

- 1 Press FM/AM on the remote control or on the front panel until the frequency band appears on the display and TV screen.

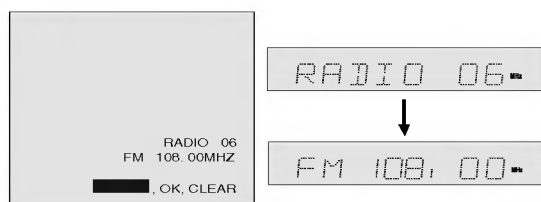

- 2 Press ▲▼ on the remote control to select your desired station.

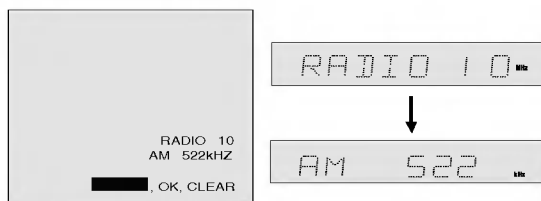

- 3 Press CLEAR the remote control to clear the stored radio station.

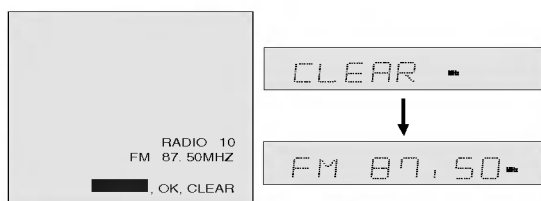

Note

- While record or record pause mode, the CLEAR function may not be operated.

Operation with Radio (Continued)

Tuning into a Station Manually

- 1** Press FM/AM on the remote control or on the front panel until the frequency band appears on the display and TV screen.
- 2** Press FM/AM on the remote control or on the front panel to select the desired band.
- 3** Press ▼ TUNING ▲ on the front panel or press ◀ and ▶ on the remote control to tune in the desired station.

Tuning into a Station Automatically

Hold down ▼ TUNING ▲ on the front panel or hold down ◀ and ▶ on the remote control for 1 or 2 seconds, and a station is searched for automatically.

Note

- The search may not stop at a station with a very weak signal.

Mute

Press MUTE to mute your unit.

You can mute your unit in order, for example, to answer the telephone, MUTING and MUTE indicator appear in the display.

Language Code List

Enter the appropriate code number for the initial settings "Disc Audio", "Disc Subtitle" and/or "Disc Menu" (See page 21).

Code	Language	Code	Language	Code	Language	Code	Language
6566	Abkhazian	7074	Fiji	7678	Lingala	8373	Singhalese
6565	Afar	7073	Finnish	7684	Lithuanian	8375	Slovak
6570	Afrikaans	7082	French	7775	Macedonian	8376	Slovenian
8381	Albanian	7089	Frisian	7771	Malagasy	8379	Somali
6577	Ameharic	7176	Galician	7783	Malay	6983	Spanish
6582	Arabic	7565	Georgian	7776	Malayalam	8385	Sudanese
7289	Armenian	6869	German	7784	Maltese	8387	Swahili
6583	Assamese	6976	Greek	7773	Maori	8386	Swedish
6588	Aymara	7576	Greenlandic	7782	Marathi	8476	Tagalog
6590	Azerbaijani	7178	Guarani	7779	Moldavian	8471	Tajik
6665	Bashkir	7185	Gujarati	7778	Mongolian	8465	Tamil
6985	Basque	7265	Hausa	7865	Nauru	8484	Tatar
6678	Bengali; Bangla	7387	Hebrew	7869	Nepali	8469	Telugu
6890	Bhutani	7273	Hindi	7879	Norwegian	8472	Thai
6672	Bihari	7285	Hungarian	7982	Oriya	6679	Tibetan
6682	Breton	7383	Icelandic	8065	Panjabi	8473	Tigrinya
6671	Bulgarian	7378	Indonesian	8083	Pashto, Pushto	8479	Tonga
7789	Burmese	7365	Interlingua	7065	Persian	8482	Turkish
6669	Byelorussian	7165	Irish	8076	Polish	8475	Turkmen
7577	Cambodian	7384	Italian	8084	Portuguese	8487	Twi
6765	Catalan	7465	Japanese	8185	Quechua	8575	Ukrainian
9072	Chinese	7487	Javanese	8277	Rhaeto-Romance	8582	Urdu
6779	Corsican	7578	Kannada	8279	Rumanian	8590	Uzbek
7282	Croatian	7583	Kashmiri	8285	Russian	8673	Vietnamese
6783	Czech	7575	Kazakh	8377	Samoan	8679	Volapük
6865	Danish	7589	Kirghiz	8365	Sanskrit	6789	Welsh
7876	Dutch	7579	Korean	7168	Scots Gaelic	8779	Wolof
6978	English	7585	Kurdish	8382	Serbian	8872	Xhosa
6979	Esperanto	7679	Laothian	8372	Serbo-Croatian	7473	Yiddish
6984	Estonian	7665	Latin	8378	Shona	8979	Yoruba
7079	Faroese	7686	Latvian, Lettish	8368	Sindhi	9085	Zulu

Country Code List

Enter the appropriate code number for the initial setting "Country Code" (See page 23).

Code	Country	Code	Country	Code	Country	Code	Country
AD	Andorra	ER	Eritrea	LC	Saint Lucia	SC	Seychelles
AE	United Arab Emirates	ES	Spain	LI	Liechtenstein	SD	Sudan
AF	Afghanistan	ET	Ethiopia	LK	Sri Lanka	SE	Sweden
AG	Antigua and Barbuda	FI	Finland	LR	Liberia	SG	Singapore
AI	Anguilla	FJ	Fiji	LS	Lesotho	SH	Saint Helena
AL	Albania	FK	Falkland Islands	LT	Lithuania	SI	Slovenia
AM	Armenia	FM	Micronesia	LU	Luxembourg	SJ	Svalbard and Jan Mayen Islands
AN	Netherlands Antilles	FO	Faroe Islands	LV	Latvia	SK	Slovak Republic
AO	Angola	FR	France	LY	Libya	SL	Sierra Leone
AQ	Antarctica	FX	France (European Territory)	MA	Morocco	SM	San Marino
AR	Argentina	GA	Gabon	MC	Monaco	SN	Senegal
AS	American Samoa	GB	Great Britain	MD	Moldavia	SO	Somalia
AT	Austria	GD	Grenada	MG	Madagascar	SR	Suriname
AU	Australia	GE	Georgia	MH	Marshall Islands	ST	Saint Tome and Principe
AW	Aruba	GF	French Guyana	MK	Macedonia	SU	Former USSR
AZ	Azerbaijan	GH	Ghana	ML	Mali	SV	El Salvador
BA	Bosnia-Herzegovina	GI	Gibraltar	MM	Myanmar	SY	Syria
BB	Barbados	GL	Greenland	MN	Mongolia	SZ	Swaziland
BD	Bangladesh	GM	Gambia	MO	Macau	TC	Turks and Caicos Islands
BE	Belgium	GN	Guinea	MP	Northern Mariana Islands	TD	Chad
BF	Burkina Faso	GP	Guadeloupe (French)	MQ	Martinique (French)	TF	French Southern Territories
BG	Bulgaria	GQ	Equatorial Guinea	MR	Mauritania	TG	Togo
BH	Bahrain	GR	Greece	MS	Montserrat	TH	Thailand
BI	Burundi	GS	S. Georgia & S. Sandwich Isls.	MT	Malta	TJ	Tadjikistan
BJ	Benin	GT	Guatemala	MU	Mauritius	TK	Tokelau
BM	Bermuda	GU	Guam (USA)	MV	Maldives	TM	Turkmenistan
BN	Brunei Darussalam	GW	Guinea Bissau	MX	Mexico	TN	Tunisia
BO	Bolivia	GY	Guyana	MY	Malaysia	TO	Tonga
BR	Brazil	HK	Hong Kong	MZ	Mozambique	TP	East Timor
BS	Bahamas	HM	Heard and McDonald Islands	NA	Namibia	TR	Turkey
BT	Bhutan	HN	Honduras	NC	New Caledonia (French)	TT	Trinidad and Tobago
BV	Bouvet Island	HR	Croatia	NE	Niger	TV	Tuvalu
BW	Botswana	HT	Haiti	NF	Norfolk Island	TW	Taiwan
BY	Belarus	HU	Hungary	NG	Nigeria	TZ	Tanzania
BZ	Belize	ID	Indonesia	NI	Nicaragua	UA	Ukraine
CA	Canada	IE	Ireland	NL	Netherlands	UG	Uganda
CC	Cocos (Keeling) Islands	IL	Israel	NO	Norway	UK	United Kingdom
CF	Central African Republic	IN	India	NP	Nepal	UM	USA Minor Outlying Islands
CG	Congo	IO	British Indian Ocean Territory	NR	Nauru	US	United States
CH	Switzerland	IQ	Iraq	NU	Niue	UY	Uruguay
CI	Ivory Coast	IR	Iran	NZ	New Zealand	UZ	Uzbekistan
CK	Cook Islands	IS	Iceland	OM	Oman	VA	Vatican City State
CL	Chile	IT	Italy	PA	Panama	VC	Saint Vincent & Grenadines
CM	Cameroon	JM	Jamaica	PE	Peru	VE	Venezuela
CN	China	JO	Jordan	PF	Polynesia (French)	VG	Virgin Islands (British)
CO	Colombia	JP	Japan	PG	Papua New Guinea	VI	Virgin Islands (USA)
CR	Costa Rica	KE	Kenya	PH	Philippines	VN	Vietnam
CS	Former Czechoslovakia	KG	Kyrgyzstan	PK	Pakistan	VU	Vanuatu
CU	Cuba	KH	Cambodia	PL	Poland	WF	Wallis and Futuna Islands
CV	Cape Verde	KI	Kiribati	PM	Saint Pierre and Miquelon	WS	Samoa
CX	Christmas Island	KM	Comoros	PN	Pitcairn Island	YE	Yemen
CY	Cyprus	KN	Saint Kitts & Nevis Anguilla	PR	Puerto Rico	YT	Mayotte
CZ	Czech Republic	KP	North Korea	PT	Portugal	YU	Yugoslavia
DE	Germany	KR	South Korea	PW	Palau	ZA	South Africa
DJ	Djibouti	KW	Kuwait	PY	Paraguay	ZM	Zambia
DK	Denmark	KY	Cayman Islands	QA	Qatar	ZR	Zaire
DM	Dominica	KZ	Kazakhstan	RE	Reunion (French)	ZW	Zimbabwe
DO	Dominican Republic	LA	Laos	RO	Romania		
DZ	Algeria	LB	Lebanon	RU	Russian Federation		
EC	Ecuador			RW	Rwanda		
EE	Estonia			SA	Saudi Arabia		
EG	Egypt			SB	Solomon Islands		
EH	Western Sahara						

Troubleshooting

Check the following guide for the possible cause of a problem before contacting service.

Symptom	Cause	Correction
No power.	<ul style="list-style-type: none"> The power cord is disconnected. 	<ul style="list-style-type: none"> Plug the power cord into the wall outlet securely.
The power is on, but the DVD/CD/VCR receiver does not work.	<ul style="list-style-type: none"> No disc is inserted. No tape is inserted. 	<ul style="list-style-type: none"> Insert a disc or tape. (Check that the disc or tape indicator in the display window is lit.)
No picture.	<ul style="list-style-type: none"> The TV is not set to receive DVD/CD/VCR receiver signal output. 	<ul style="list-style-type: none"> Select the appropriate video input mode on the TV so the picture from the DVD/CD/VCR receiver appears on the TV screen.
	<ul style="list-style-type: none"> TV/VCR mode for DVD/CD/VCR receiver is set to TV. 	<ul style="list-style-type: none"> Press the TV/VCR button on the remote control repeatedly to choose VCR mode. TV indicator disappears in the display window.
	<ul style="list-style-type: none"> The video cable is not connected securely. 	<ul style="list-style-type: none"> Connect the video cable securely.
	<ul style="list-style-type: none"> The connected TV power is turned off. 	<ul style="list-style-type: none"> Turn on the TV.
No sound.	<ul style="list-style-type: none"> The equipment connected with the audio cable is not set to receive DVD/CD/VCR receiver signal output. 	<ul style="list-style-type: none"> Select the correct input mode on the audio receiver so you can listen to the sound from the DVD/CD/VCR receiver.
	<ul style="list-style-type: none"> The audio cables are not connected securely. 	<ul style="list-style-type: none"> Connect the audio cables securely.
	<ul style="list-style-type: none"> The power of the equipment connected with the audio cables is turned off. 	<ul style="list-style-type: none"> Turn on the equipment connected with the audio cables.
	<ul style="list-style-type: none"> The digital audio output is set to the wrong position. 	<ul style="list-style-type: none"> Set the digital audio output to the correct position, then turn on the DVD/CD/VCR receiver again by pressing POWER.
The playback picture is poor.	<ul style="list-style-type: none"> The disc is dirty. 	<ul style="list-style-type: none"> Clean the disc.
	<ul style="list-style-type: none"> Tape heads are dirty. 	<ul style="list-style-type: none"> Clean video heads.
	<ul style="list-style-type: none"> Tape is a rental or was recorded on another VCR. 	<ul style="list-style-type: none"> Use PR/TRK (▲/▼) for manual tracking adjustment while tape is playing.
The DVD/CD/VCR receiver does not start playback.	<ul style="list-style-type: none"> No disc is inserted. No tape is inserted. 	<ul style="list-style-type: none"> Insert a disc or tape. (Check that the disc or tape indicator in the display window is lit.)
	<ul style="list-style-type: none"> An unplayable disc is inserted. 	<ul style="list-style-type: none"> Insert a playable disc. (Check the disc type, color system, and Regional code.)
	<ul style="list-style-type: none"> The disc is placed upside down. 	<ul style="list-style-type: none"> Place the disc with the playback side down.
	<ul style="list-style-type: none"> The disc is not placed within the guide. 	<ul style="list-style-type: none"> Place the disc on the disc tray correctly inside the guide.
	<ul style="list-style-type: none"> The disc is dirty. 	<ul style="list-style-type: none"> Clean the disc.
	<ul style="list-style-type: none"> The Rating level is set. 	<ul style="list-style-type: none"> Cancel the Rating function or change the rating level.
The remote control does not work properly.	<ul style="list-style-type: none"> The remote control is not pointed at the remote sensor of the DVD/CD/VCR receiver. 	<ul style="list-style-type: none"> Point the remote control at the remote sensor of the DVD/CD/VCR receiver.
	<ul style="list-style-type: none"> The remote control is too far from the DVD/CD/VCR receiver. 	<ul style="list-style-type: none"> Operate the remote control within 23 ft (7 m).
	<ul style="list-style-type: none"> There is an obstacle in the path of the remote control and the DVD/CD/VCR receiver. 	<ul style="list-style-type: none"> Remove the obstacle.
	<ul style="list-style-type: none"> The batteries in the remote control are exhausted. 	<ul style="list-style-type: none"> Replace the batteries with new ones.
	<ul style="list-style-type: none"> This remote control uses the same buttons for VCR and DVD functions (ex. PLAY). 	<ul style="list-style-type: none"> When using a VCR, first press the VCR button. When using a DVD, first press the CD/DVD button.



Troubleshooting (Continued)

Symptom	Cause	Correction
The tape does not run during recording.	<ul style="list-style-type: none"> The DVD/CD/VCR receiver is in the RECORD PAUSE MODE. 	<ul style="list-style-type: none"> Press PAUSE/STEP (II) to resume recording.
The tape will not rewind or fast-forward.	<ul style="list-style-type: none"> The tape is already fully rewound or fast-forwarded. 	<ul style="list-style-type: none"> Check the tape.
The playback picture does not appear while the tape is running.	<ul style="list-style-type: none"> If you're using only the RF cable for connection. 	<ul style="list-style-type: none"> Set the TV to the Video channel (see p. 15).
Noise appears during visual search.	<ul style="list-style-type: none"> This is normal. 	<ul style="list-style-type: none"> Turn camcorder on and operate properly.
Noise appears during normal playback.	<ul style="list-style-type: none"> The automatic tracking mode is engaged. 	<ul style="list-style-type: none"> Try manual tracking (see p. 24).
Breaks are noticeable in Hi-Fi soundtrack.	<ul style="list-style-type: none"> The automatic tracking mode is engaged. 	<ul style="list-style-type: none"> Try manual tracking (see p. 24).
Recording cannot be started.	<ul style="list-style-type: none"> There is no tape loaded, or the tape loaded has had its record safety tab removed. 	<ul style="list-style-type: none"> Insert a tape, or using adhesive tape, cover the hole where the tab was removed.
Tape-to-tape editing is not possible.	<ul style="list-style-type: none"> The source (another VCR, camcorder) has not been properly connected. 	<ul style="list-style-type: none"> Confirm that the camcorder is properly connected.
Timer recording won't work.	<ul style="list-style-type: none"> The clock/or the timer have been set incorrectly. The timer is not engaged. The loaded tape has had its record safety tab removed. 	<ul style="list-style-type: none"> Re-perform the clock and/or timer settings. Press POWER and confirm that the timer indicator is displayed on the DVD/CD/VCR receiver's Display. Insert a tape with adhesive tape, or insert a tape with the record safety tab intact.
No Hi-Fi sound.	<ul style="list-style-type: none"> Audio mode is not set properly. 	<ul style="list-style-type: none"> Select "STEREO" by repeatedly pressing AUDIO on the remote control.

Moisture Condensation

Moisture condensation can occur:	In locations where moisture condensation may occur:
<ul style="list-style-type: none"> When the DVD/CD/VCR receiver is moved from a cold place to a warm place. Under extremely humid conditions. 	<ul style="list-style-type: none"> Keep the DVD/CD/VCR receiver plugged into an AC power outlet with POWER On. This will help prevent condensation. When condensation has occurred, wait a few hours for the DVD/CD/VCR receiver to dry before using it.

Specifications

General

Power requirements	AC 110/230V~, 50/60 Hz
Power consumption	130 W
Dimensions (approx.)	430 X 90 X 350 mm (w x h x d)
Mass (approx.)	8 kg (17.6 lbs)
Operating temperature	5°C to 40°C (41°F to 104°F)
Timer	24-hour display type
Operating humidity	5 % to 90 %

DVD Section

Laser	Semiconductor laser, wavelength 650 nm
Signal system	PAL/NTSC
Frequency response	DVD (PCM 96 kHz): 8 Hz to 44 kHz DVD (PCM 48 kHz): 8 Hz to 20 kHz CD: 8 Hz to 20 kHz
Signal-to-noise ratio	More than 70 dB (analog out connectors only)
Harmonic distortion	Less than 1.0%
Dynamic range	More than 60 dB (DVD) More than 60 dB (CD)

Outputs

S-VIDEO OUT	(Y) 1.0 V (p-p), 75 ohms, negative sync, Mini DIN 4-pin x 1 (C) 0.3 V (p-p) 75 ohms
-------------	--

VCR Section

Head system	4 heads helical scan azimuth system
Television system	PAL/SECAM colour system
Recording format	PAL/MESECAM
RF OUT	G
RF Modulator	UHF 22-68 (Adjustable)
Tape speed	PAL/MESECAM; 23.39 mm/s (SP), 16.69 mm/s (LP) NTSC (Playback only); 35.35 mm/s (SP), 16.67 mm/s (LP), 11.12 mm/s (EP)
Maximum recording time	SP: 4 h (E-240 tape), LP: 8 h (E-240 tape)
Rewind time	About 180 min (E-180 tape)
Input level	VIDEO: 1.0 V(p-p), 75 ohms, unbalanced AUDIO: -6.0 dBm, more than 10 kohms (SCART) -6.0 dBm, more than 47 kohms (RCA)
Output level	VIDEO: 1.0 V(p-p), 75 ohms, unbalanced
Signal-to-noise ratio	VIDEO: More than 43 dB AUDIO: More than 72 dB (Hi-Fi) More than 42 dB (Mono)
Dynamic range	AUDIO: More than 85 dB

Tuner Section

Tuning range	FM: 87.5 - 108.0 MHz AM: 522 - 1611 kHz or 530 - 1610 kHz
Intermediate frequency	FM: 10.7 MHz AM: 450 kHz

Amplifier Section

Stereo mode	20W + 20W (4 ohm at 1 kHz, THD 10%)
Surround mode	Front: 20W + 20W (THD 10%) Centre: 20W Surround: 20W + 20W (4 ohm at 1 kHz, THD 10%) Subwoofer: 40W (8 ohm at 30 Hz, THD 10%)

Specifications (Continued)

Speaker Section

Satellite (LHS-C6231T)

Type	1 Way 1 Speaker
Impedance	4 Ω
Frequency Response	130 - 20,000 Hz
Sound Pressure Level	83 dB/W (1m)
Rated Input Power	20W
Max Input Power	40W
Net Dimensions (W x H x D)	88 x 100 x 95 mm
Net Weight	0.54 kg

Passive Subwoofer (LHS-C6231W)

Type	1 Way 1 Speaker
Impedance	8 Ω
Frequency Response	50 - 1,500 Hz
Sound Pressure Level	82 dB/W (1m)
Rated Input Power	40W
Max Input Power	80W
Net Dimensions (W x H x D)	160 x 350 x 325 mm
Net Weight	4.12 kg

Accessories:

RF 75-ohm Coaxial Cable x 1, Speaker cable x 5, RCA-SCART cable x 1, AM loop antenna x 1, FM antenna x 1, Remote control x 1, Batteries (AAA) x 2

- Design and specifications are subject to change without notice.

Manufactured under license from Dolby Laboratories. "Dolby", "Pro Logic" and the double-D symbol are trademarks of Dolby Laboratories.

"DTS" and "DTS Digital Out" are trademarks of Digital Theater Systems, Inc.



NOTE



P/N: 3828R-D036E