



Washing Machine **OWNER'S MANUAL**

MODEL: WF-5246TTC



carefully before operating your set.

serial number of the set.

back side and quote this in-

require service.



If the lid is opened during spin cycles, the machine will stop automatically.

Fuzzy Logic Control

- A built-in load sensor automatically detects the laundry load and a microprocessor optimizes washing conditions such as ideal water level and washing time.
- Advanced technology is built into the Electronic Control System which ensures the best washing result.



3 Step washing

- 3 step washing makes the best washing performance with low tangling.



Rubbing

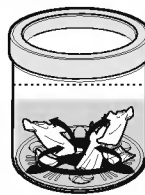

Rubbing and Shaking



Shaking and Disentangling

Lint Filter

- Lint and loose threads from laundry generated during the washing cycle are caught by the lint filter for a cleaner wash.



Read This Manual

Inside you will find many helpful hints on how to use and maintain your washer properly. Just a little preventive care on your part can save you a great deal of time and money over the life of your washer. You will find many answers to common problems in the Troubleshooting section. If you review our chart of Troubleshooting Tips first, you may not need to call for service at all.

Introduction	Safety Information	4
	Identification of Parts	5
Before Starting to Wash	Function Information	6
	Preparation Before Washing	7
	Use of Water, Detergent, Bleach and Softener	8
	Function of each Button	10
Washing Programs	Fuzzy Wash (Normal Wash)	12
	Economy Wash	12
	Night Wash	12
	Wool Wash	12
	Soak Wash	12
Additional function Options	Delay Start (Reservation) Wash	14
	Option Washing	15
	Other useful Functions	16
Installation	Placing and Leveling	17
	Connecting Water Supply Hose	18
	Connecting Drain Hose	21
Care and Maintenance	Grounding Method	22
	Cleaning and Maintenance	23
Troubleshooting	Troubleshooting	25
Specification	Specification	27



WARNING!

For your safety, the information in this manual must be followed to minimize the risk of fire or explosion, electric shock, or to prevent property damage, personal injury, or loss of life.

For your better understanding, these precautions are separated into two categories.

We urge you to pay special attention to them in the interests of your own safety, and protection of your machine against damage:

Violation of these guidelines could result in serious or fatal injury.

Following these guidelines will protect your machine against damage.

Installation	<ul style="list-style-type: none"> ● The appliance is not intended for use by young children or infirm persons without supervision. ● Do not install the washing machine in a damp place. ● Keep the washing machine away from fire or heat source. ● Young children should be supervised to ensure that they do not play with the appliance. ● The base opening must not be obstructed by carpeting when the washing machine is installed on a carpeted floor. 	<ul style="list-style-type: none"> ● Do not put your hands or feet under this machine. ● Do not place any rugs or heavy material over the power cord. ● Since the machine is heavy, a minimum of two persons should move it. ● Do not install the washer where it is exposed to sunlight, wind, rain, etc. ● The appliance must be positioned so that the plug is accessible.
Power Supply cord	<ul style="list-style-type: none"> ● Make sure to ground the earth wire or connect it to a ground detector after you put the power cord into an outlet. ● When the power cord is loose, do not use it. ● Do not plug many cords into one outlet at the same time. ● If the power cord or fuse is damaged, it must be replaced by the manufacturer or its service agents or similarly qualified people in order to avoid a hazard. ● If the appliance is supplied from a cord extension set or electrical portable outlet device the cord extension set or electrical portable outlet device should be positioned so it is not subject to splashing or ingress of moisture. ● Do not place any electric appliance with a charging battery, magnetically-driven appliance and magnetic body on the washer. 	<ul style="list-style-type: none"> ● Make sure the power cord is free of dust and plug it in properly so that the cord will not move. ● Do not touch the power cord with wet hands.
Operation	<ul style="list-style-type: none"> ● When you take out the laundry, be careful not to fall into the washer. ● Do not put hands into the rotating tub. ● Do not sprinkle water over the buttons. ● Make sure the lid is closed during operation of the spin cycle. 	<ul style="list-style-type: none"> ● Do not press the buttons with sharp objects. ● Check the hose connection and open the tap before activating the machine. ● Do not pour more than 50°C (122°F) water into the tub. ● Do not wash any waterproof materials.
Maintenance	<ul style="list-style-type: none"> ● Do not put heavy objects on the machine. ● Unplug the cord when the machine is not in use. 	<ul style="list-style-type: none"> ● Do not pour corrosive materials or bleach over the washing machine. It will cause damage to the power cord or the machine. ● Never disassemble or remodel the washer and power cord by yourself. Only a qualified technician should work on the machine.

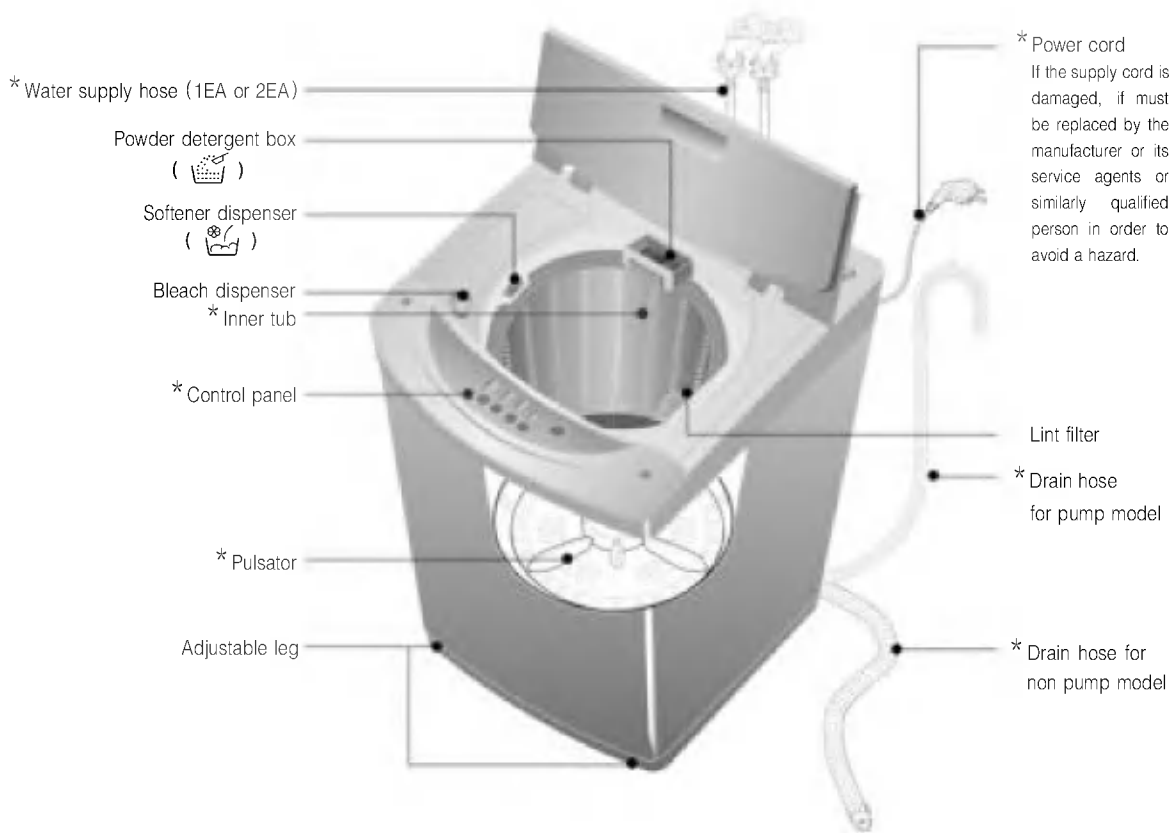

* Power cord
If the supply cord is damaged, it must be replaced by the manufacturer or its service agents or similarly qualified person in order to avoid a hazard.

Water supply hoses

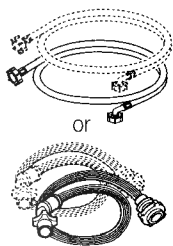

1 Each for cold and hot water

Drain hose

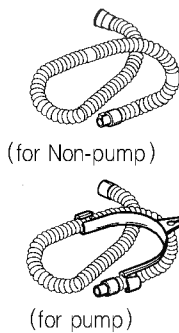

* Anti-rat cover(option)



“* ” Part can be different according to the model.

Function Information

Our machine provides various washing methods which suits various conditions and types of laundry.

Different types of laundry washing

Use this Program for normal clothes except for woolen clothes and lingerie.

The sensor automatically detects the quantity of laundry and selects the appropriate water level, wash power, washing time, rinsing time and spinning time. (refer to p12)

Economy wash can be selected to wash lightly soiled clothes of less than 2.0kg in a short time. (refer to p12)

Use this program for washing laundry during night.

Delicate clothes (lingerie, wool, etc.) which may be easily damaged can be washed. (refer to p12)

Soak Wash can be selected to wash heavily soiled laundry by soaking it in water for sometime to remove dirt and grime. (refer to p12)

Other washing method

Delay start(Reservation) Wash is used to delay the **finishing time** of the operation.

Delayed Start washing can be set according to preference. . (refer to p14)

Spin, Rinse/Spin, Rinse, Wash/Rinse, and Wash only options can selected. (refer to p15)

To get the best results, different fabrics need to be washed in different ways.

- SOIL** (Heavy, Normal, Light) Separate clothes according to the type and amount of soil.
COLOR (Whites, Lights, Darks) Separate white fabrics from colored fabrics.
LINT (Lint producers, Collectors) Separate lint producers and lint collectors.

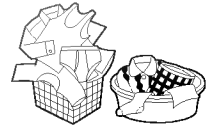

- Check all pockets to make sure that they are empty. Things such as nails, hairclips, matches, pens, coins, and keys can damage both your washer and your clothes.
- Close zippers, hooks and strings to make sure that these items, don't snag on other clothes.
- Mend any torn garments or loose buttons. Tears or holes may become larger during washing.
- Remove any loose brassiere wires as they can damage your washing machine and clothes.
- Pre-treat any dirt and stains.
- Make sure the clothes are washable in water.
- Check the washing instructions.

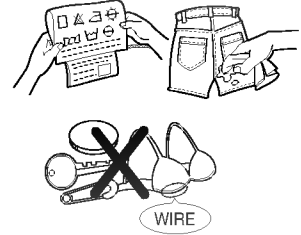

Brush a little detergent dissolved in water onto stains like collars and cuffs to help shift dirt.
Treat stains as soon as possible. The longer they are left the harder they are to remove.



Clothes like downs and woollens are light weight, large and float easily. So use a nylon net and wash them in a small amount of water.
If the laundry floats during the wash cycle, it may become damaged.
Use dissolved detergent to prevent the detergent from clumping.



Use nylon nets for long, delicate items.
For laundry with long strings or long length, a net will prevent tangling during washing.
Fasten zippers or hooks on items before washing.
* Nylon net is not supplied by LG.

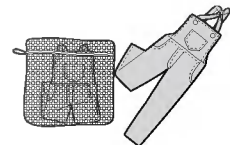

Use of Water, Detergent, Bleach and Softener

Using water

- This machine detects the quantity of laundry automatically, then sets the water level and proper amount of detergent.
- When you select a wash program, the water level and amount of detergent (to be used) will be shown on the control panel.
- When the water level is automatically detected, it may differ depending on the quantity of laundry even though the same water level is indicated on the control panel.



Using Detergent and Fabric Softener

- When you select a wash program, the water level and the amount of detergent will be shown on the control panel. The amount of a cup in the diagram is about 40g for concentrated detergent.
- For the correct amount of detergent, refer to detergent manufacturer's instruction.

- Synthetic detergents that yield a low level of foam are recommended.
- When liquid detergent is used, mix it with water (1:1) and pour it into the bleach dispenser.



If excessive detergent is used, the rinse will not be as clean and efficient. Also, it could cause environmental pollution, so use it accordingly.

- Do not use concentrated fabric softener. This may cause some problems in automatic dispensing.
- For more details refer to the softener products instructions for use.

- Open the detergent box and deposit the appropriate amount of detergent.

Powder Detergent Box ()

Where you deposit the detergent

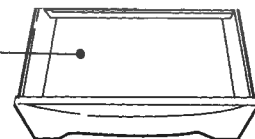

- Fabric softener is automatically dispensed in the final rinse with indication beep.
- Don't use softener with detergent. Use softener in last rinse water. When using dispenser, dilute softener (30ml) with fresh water (30ml).
- When filling dispenser, do not splash or overfill. It may stain clothes.
- Never pour fabric softener directly on clothes. It may stain them.
- If spotting occurs, wet and rub hand dishwashing liquid (or mild bar soda) and rewash.

Softener dispenser ()

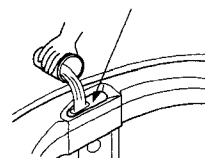

- The effect of adding fabric softener may vary according to its viscosity. The stickier fabric softener makes its effect the lower. For a sticky fabric softener it is recommended that it be diluted with water, then be manually put during the time when the washer beeps several times before the final rinse. This function informing correct time to dispense manually. Please keep it in mind that fabric softener has to be diluted with water before dispensed and never poured directly on clothes.

Using Bleach

Check fabric care labels for special instructions.

- Use oxygenated bleach.
- Powdered bleach should be mixed with water and then be deposited into the tub.
- For more details refer to the products instruction for use.

- Separate the laundry to be bleached and deposit liquid bleach into the Bleach dispenser. The dispenser dilutes liquid chlorine bleach before it reaches into your wash load.

Bleach dispenser

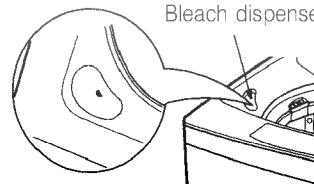

- Never pour undiluted liquid bleach directly onto clothes or into the wash basket. This may cause change of color or damage the laundry.
- Do not mix chlorine bleach with ammonia or acids such as vinegar and/or rust remover. Mixing can produce a toxic gas which may cause death.

- Use to adjust the water level as required. The appropriate amount of detergent is shown next to the water level in the WATER-DETERGENT diagram.
- Water level is automatically selected for fuzzy(normal) and night program.
The following settings are indicated as the button is pushed
LARGE ► EX-LARGE ► SMALL ► MEDIUM ► LARGE

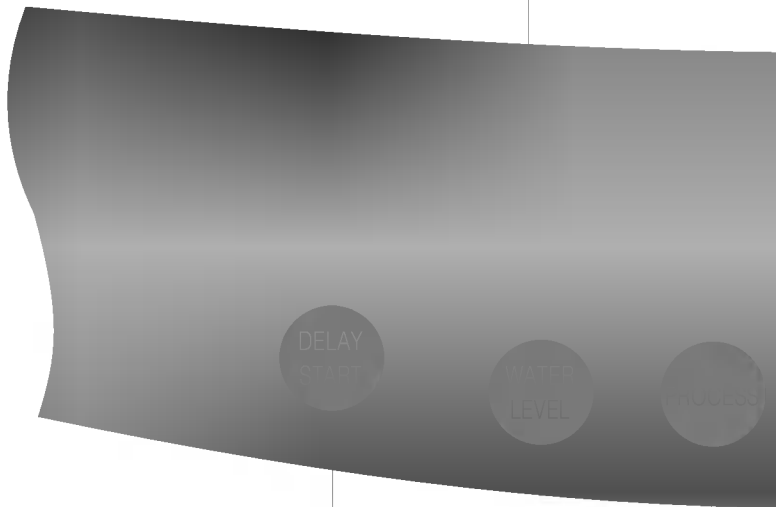

- Use to set a delayed finishing time.
The time changes 6→9→15(6+9) →6hr when the button is pushed. (refer to p14)

- Use to select SOAK, WASH, RINSE and SPIN functions as desired.

* The control plate may differ according to different models

- Use for selecting wash program.
- This button allows you to select 4 different programs for different kinds of laundry and dirtiness.
- Program selections light up in sequence as follows: FUZZY(NORMAL) ► ECONOMY ► NIGHT ► WOOL ► FUZZY(NORMAL) etc. Select the desired program by pressing the button.



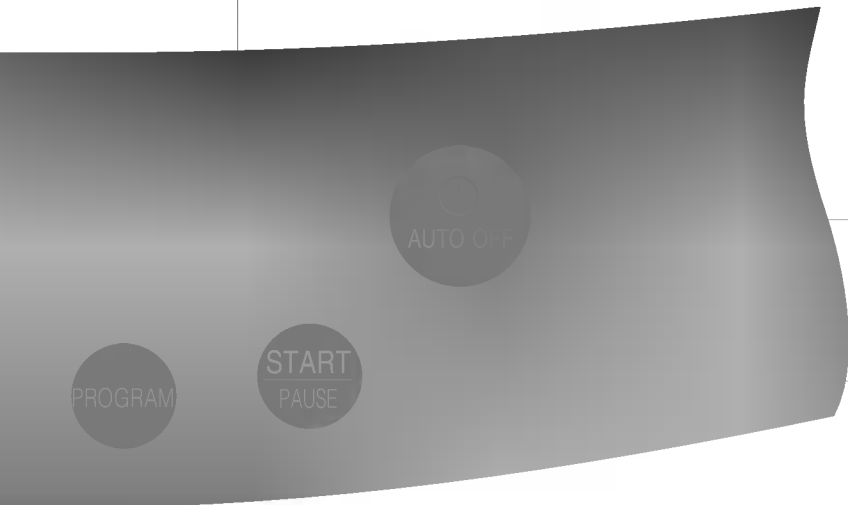



















- Use to turn the power on or off.
- The power goes off automatically about 10 seconds after the wash is finished.

















- Use to lock or unlock the control buttons to prevent settings from being changed by a child. To lock, push the PROCESS and PROGRAM buttons simultaneously and to unlock push them one more time during the washing process. (refer to p16)

- Use to start or pause the washing process.
- Repeats start and pause by pushing the button.
- The power goes off automatically 10 minutes in pause state.

* ● : 3 step works at large and medium water level of FUZZY and NIGHT course.
 ecosave works at FUZZY and NIGHT course.

Washing Programs		Add the laundry			Add the detergent
<p>Fuzzy Washing (Normal Wash)</p> <p>Used for normal loads, this mode automatically selects the most appropriate conditions and completes the sequence in one operation. The built-in sensor detects the size of the load and the ideal wash power and wash, rinse and spin times are set accordingly.</p>					<p></p> <ul style="list-style-type: none"> • Add the appropriate quantity of detergent as indicated by the water level next to WATER DETERGENT. Or follow the detergent manufacturer's instructions.
<p>Economy Wash</p> <p>Use this mode when washing lightly soiled clothes for a short time. The weight should be under 2.0kg.</p>			<p></p> <ul style="list-style-type: none"> • Select the ECONOMY program on the Control plate. 		
<p>Night Wash</p> <p>Use Night program when wash in night.</p>			<p></p> <ul style="list-style-type: none"> • Select the NIGHT program on the Control plate. 		
<p>Wool Wash</p> <p>Use this program for washing delicate fabrics such as lingerie and woolens. (wash only "water washable" clothes) Before washing your woolens check the care label for the washing instructions. (wash only "water washable" clothes)</p>			<p></p> <ul style="list-style-type: none"> • Select the WOOL program on the Control plate. 		<p></p> <ul style="list-style-type: none"> • Use neutral detergent appropriate for the laundry. • When washing woolers use a mild detergent recommended for washing wool.
<p>Soak Wash</p> <p>Use this mode for washing excessively dirty laundry by soaking in water for some time to remove proteins and fats. "SOAK" mode can be used with all washing programs simultaneously except for "WOOL" and "ECONOMY" program.</p>			<p></p> <ul style="list-style-type: none"> • The SOAK will not work in WOOL Program. 		<p></p> <ul style="list-style-type: none"> • Keep pressing the PROCESS button until the SOAK light is on and then WASH, RINSE, SPIN lights are on simultaneously. • If necessary, select the desired washing process from (SOAK + WASH + RINSE + SPIN), (SOAK + WASH + RINSE), (SOAK + WASH) manually.



●	Close the lid	Finish	Caution & Note
 <ul style="list-style-type: none"> • The pulsator rotates for 8 seconds to detect the laundry load. • Then the water level and the amount of detergent to be used will be shown and water will be supplied. 	 <ul style="list-style-type: none"> • Water will be supplied for 2 minutes after the start of the wash to supplement the water the laundry has absorbed. 	 <ul style="list-style-type: none"> • When the wash program ends, the buzzer will ring for 10 seconds before the power goes off automatically. 	<ul style="list-style-type: none"> • If water is already in the tub, or putting wet laundry into the tub before starting will increase the water level. • With light weight bulky loads, water level can be set low.
			
			
			<ul style="list-style-type: none"> • When setting the water level manually, do not set to MEDIUM to prevent damage to laundry. • Washing with hot water may damage the laundry (Water is set to cold automatically). Ensure that the load is under 2kg. • In order to avoid damage to laundry, the spin cycle may appear slow. This also avoids wrinkles and clothing may still contain some water. This is normal. • Soak Wash cannot be selected for the Wool and Economy Wash program.
 <ul style="list-style-type: none"> • The water level and the amount of detergent to be used will be shown and water will be supplied. 			

Delay Start (Reservation) Wash is used to delay the finishing time of the operation.
The hours to be delayed can be set by the user accordingly.
The time is the finishing time, not the start time.

Press the **POWER** button to turn power on.



Press the **PROGRAM** button to select the washing program.



- Select the program for laundry on the Control plate.
This program will not work in Wool Program.

Press the **DELAY START (Reservation)** button to set the time when the delayed washing is to be completed.



- The Time changes as following order
(6→9→15→6Hours).



Add the laundry and press the **START/PAUSE** button.



- When you press the **START/PAUSE** button the light will blink.

Add the detergent.

- The appropriate quantity of detergent marked next to the water level of **WATER-DETERGENT**.
- When the lid is open the machine will not operate, and an alarm signal will remind you to close the lid.

Close the lid.

- Water will be supplied for 2 minutes after the start of the wash to supplement the water the laundry has absorbed.

Finish

The washing will be finished according to the delayed time.

- If the lid is opened during spin cycles, the machine will not work, and an alarm signal will alarm to remind you to close the lid.
- To select washing program, spinning time, water level manually, press the **DELAY START (RESERVATION)** button and select the desired option. Then press the **START/PAUSE** button.
- When the laundry cannot be taken out immediately after the wash program ends, it is better to omit the spinning program. (The laundry will be wrinkled if left for a long time after spinning).

When you only need the Wash, Wash/Rinse or Rinse cycles, these can be set manually

Press the AUTO OFF (Power) button to turn power on.



Wash, Wash + Rinse, Rinse, Rinse + Spin, Spin Only options



- Press the PROCESS button until above Option Washing light is on. (refer to p11)
- When you want to only drain, wait until the water in the washing tub drains completely and then, turn off the power.

Press the WATER LEVEL button, to control the water level according to the amount of laundry. If you do not choose anything, it is set the LARGE water level automatically.



Add the laundry into the washing tub.

Press the START/PAUSE button.



Add the detergent and close the lid.

- When a Wash, Wash/Rinse or Rinse only option is selected, the water will not be drained off after the wash is completed. If you wish to drain the water, press the SPIN button and wait until the water in the tub has drained completely. Then press the START/PAUSE button.
- If you do not specify the water level, then LARGE will be automatically selected.
- If only Rinse is selected, the process will start from Water Supply.

Child Lock Function

If you want to lock all the keys to prevent settings from being changed by a child, you can use the child lock option.

Press the POWER button.



- Turn Power on.

Press the START/PAUSE button to start washing.



- After all washing conditions are set according to the manual.

Press both the PROCESS button and the PROGRAM button simultaneously.



- During the wash program, all the buttons are locked until washing is completed or until the child-lock function is deactivated manually.

If you want to unlock during wash, press both the PROCESS and the PROGRAM button simultaneously again.

Mute Option

If you want to use the washing machine without alarm signal sounds, press both the WATER LEVEL and PROCESS buttons simultaneously.

To make buzzer work, press both the WATER LEVEL and PROCESS buttons simultaneously one more time.

Please ensure that transit restraint has been removed before operating your machine.

Place the machine on a flat and firm surface which allows proper clearance.

We suggest a minimum clearance of 2cm to the right side and left side of the machine for ease of installation. At the rear, a minimum clearance of 10cm is suggested.

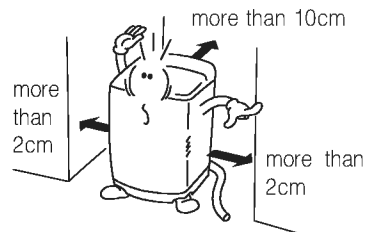

Check that the machine is level

Open the lid and look from above to see if it is same as shown.

Top view of the machine

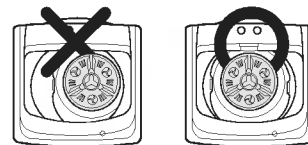

Leveling the machine

Lift the front of the washing machine and twist the Adjustable Leg until the washing machine is placed evenly.

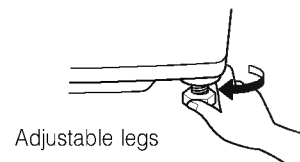

* Installing the Anti-Rat Cover (option)

The Anti-Rat cover should be affixed firmly from the back of the washer.

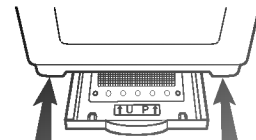

If the power is supplied from a cord extension set or generator, the cord extension set or electrical portable outlet device should be positioned so that it is not exposed to splashing or ingress of moisture.

Before connecting the Water Supply Hose to the water tap, check the hose type and then choose the correct instruction here under.

Note that the Water Supply Hose supplied may vary from country to country, Make sure to connect the blue inlet hose to the cold water tap, and the orange inlet hose to the hot water tap.

Connecting Water Supply Hose to water tap

(Normal tap without thread & screw type inlet hose.)

Untighten the screw

Untighten the screw of the connector so that the tap can be placed in the middle.

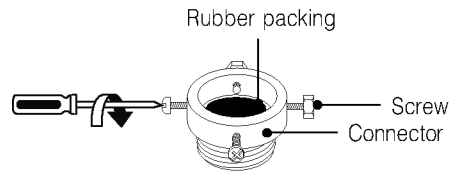

Fixing the connector to the tap

Push the upper connector up till the rubber packing is in tight contact with the tap. Then tighten the 4 screws.

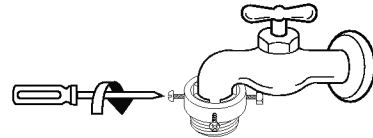

Attach the water supply hose securely to the connector

Push the water supply hose vertically upwards so that the rubber seal within the hose can adhere completely to the tap.

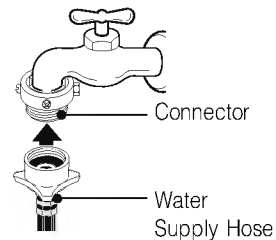

Fixing the connector to the water supply hose

Attach the water supply hose to the connector and then tighten it by screwing it to the right.

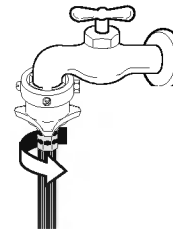

Check the connection of water supply hose and the connector

After connecting the hose, open the tap to check for any water leakage.

If the water leaks, close the tap and start again from step 1.

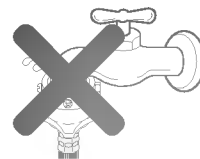

(Normal tap without thread & one touch type inlet hose.)

Separate Middle connector from Water Supply Hose

Separate Middle connector from the Water Supply Hose by pulling the Pressing Rod and the Pressing Handle that is attached to the Water Supply Hose.

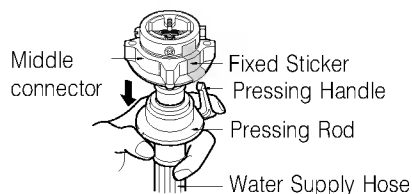

Loosen the fixed nuts to connect the connector to the tap

Untighten the screw of the connector so that the tap can be placed in the middle.

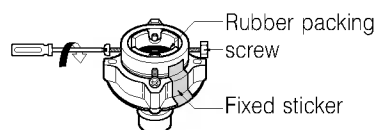

In case tap is too large.

If the tap diameter is too large or is square, untighten the 4 screws and remove the guide plate. Then follow step 1.

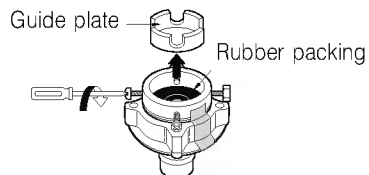

Fixing connectors to the Tap

Push the upper connector up till the rubber packing is in tight contact with the tap. Then tighten the 4 screws.

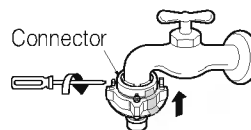

Fixing Upper Connector and Middle Connector

Remove the fixed sticker in between the Upper and Middle Connectors. Tighten the connectors by holding one connector and twist middle connector to the right.

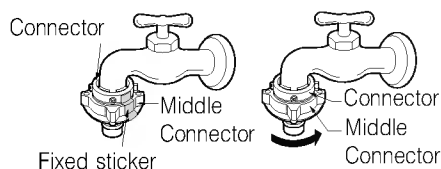

Connecting Middle Connector and Water Supply Hose

Press down the pressing rod of the Water Supply Hose which was separated from middle connector (refer to Step 1) and then join it to the middle connector.

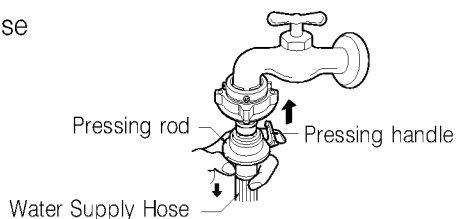

Check for water leakage

After connecting the hose, open the tap to check for any water leakage. If the connection leaks, close the tap and start again from step 1. If you skip step 1, water leakage may occur.

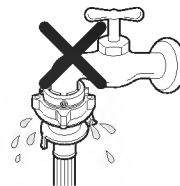

Attach the water supply hose to the tap.

Push the water supply hose up so that the rubber packing within the hose can adhere completely to the tap.

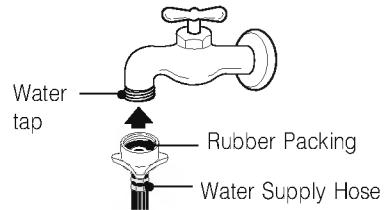

Connect the water supply hose to the tap.

Connect the water supply hose to the tap and then tighten it by screwing it to the right.



Check water leakage.

After connecting the hose, open the tap to check for any water leakage.

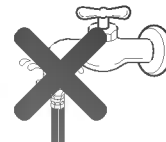

Connecting Water Supply Hose to the machine

- Connect the water supply hose to inlet valve of the washing machine, and then lock it by turning the hose connecting part.

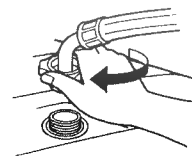

- Check to see if there is a rubber seal inside the connector.

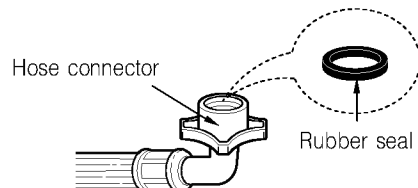

- Washing machine is to be connected to the water mains using new hose-sets and that old hose-sets should not be reused.

Connecting Drain Hose

Before connecting Drain Hose, check your Drain Hose model and choose the correct instructions.

1 Before connecting

Ensure that the hose clip is set as indicated here.

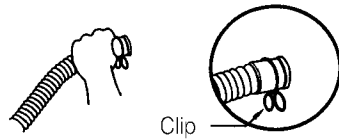

2 Connect the Drain Hose

Connect the drain hose to the outlet of the drain located at the side of the washing machine.

Push the drain hose toward the body as in the figure, and then fix it with the clip.

Keep it downward while the washing machine is working. Ensure the hose is free from kinking.

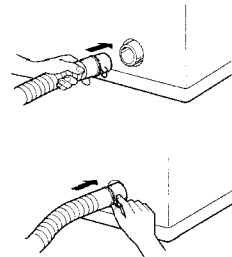

Earth wire should be connected.

If the earth wire is not connected, there is possible a danger of electric shock caused by the current leakage.

Grounding Method with Ground insert space Terminal

If the AC current outlet has a ground terminal, then separate grounding is not required. Note that AC power outlet configurations may differ from country to country

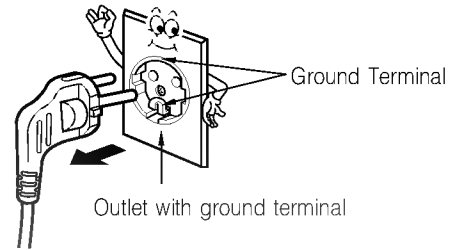

Other Grounding Method

Connect the Ground Wire to a Ground Copper Plate and bury it more than 75cm in the ground.

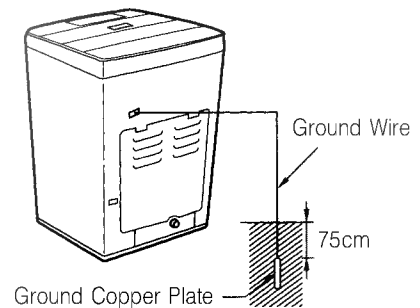

Connect the ground Wire to the socket provided exclusively for Grounding.

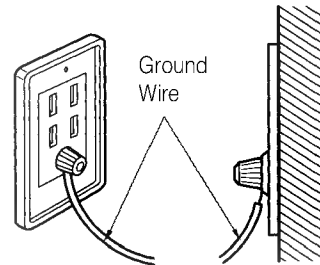

If grounding methods described above are not possible, a separate circuit breaker should be employed and installed by a qualified electrician.

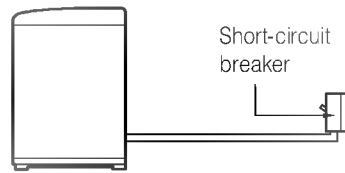

- To prevent a possible explosion, do not connect ground to a gas pipe.
- Do not connect ground to telephone wires or lightning rods. This may be dangerous during electrical storms.
- Connecting ground to plastic has no effect.
- Ground wires should be connected when an extension cord is used.

When water supply into the tub is not clean or the filter is clogged with particles (such as sand), clean the filter in the inlet valve occasionally. (The figure of power cord and water tap may vary according to the country)

To Clean the Filter in the Inlet Valve

Close the tap before turning off the power. Remove water from the machine completely.



Turn off the power before pulling out the cord.

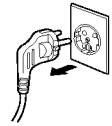

After removing the water supply hose pull out the filter. Then use a brush to clean the filter.

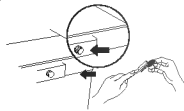

Replace the filter after cleaning it.

Before cleaning the filter, the immediate water supply hose should be removed.

To Clean the Lint Filter

Pull out the lint filter from the tub in the direction shown below.



Turn the net inside out to clean the filter and rinse it with water.



Replace the filter to the original location. Push the lip of the filter until a pop sound is heard.



- If the lint filter is torn or damaged, purchase a new one from LG service center.

Cleaning

WHEN THERE IS A FEAR OF FREEZING

- 1 Close the water taps and remove the Water Supply Hose.
- 2 Remove the water which remains in the water supply.
- 3 Lower the drain hose and drain the water in the bowl and the drain hose by spinning.

IF FROZEN

- 1 Remove the water supply hose, and immerse it in hot water at approx. . 40°C.
- 2 Pour approx. . 2 liters of hot water at approx. . 40°C, into the bowl and let it stand for 10 minutes.
- 3 Connect the water supply hose to the water tap and confirm that the washing machine performs the supply and drainage of water.

Wash Inner-tub	Leave the lid open after washing to allow moisture to evaporate. If you want to clean the inner-tub use a clean soft cloth dampened with liquid detergent, then rinse. (Do not use harsh or gritty cleaners.)
Inlet Hoses	Hoses connecting washer to faucet should be replaced every 5 years.
Exterior	Immediately wipe off any spills. Wipe with damp cloth. Try not to hit surface with sharp objects.
Long Vacations	Be sure water supply is shut off at faucets. Drain all water from hoses if weather will be below freezing.

SCRUD

Scrud is the name given to the waxy build-up that can occur within any washer when the fabric softener comes into contact with detergent. This build-up is not brought about by a fault in the machine.

If scrud is allowed to build-up in the machine it can result in stains on your clothes or an unpleasant smell in your washer.

- Using fabric the dispenser, do not splash or overfill.
- Clean dispenser as soon as the cycle has finished.
- Clean your machine regularly.
- Cold water washing increases the chance of this build-up occurring. We recommend a warm or hot wash at regular intervals e. g. approx. every 5th wash.
- Fabric softener of thinner consistency is less likely to leave residue on the dispenser and contribute to a build-up.

CLEANING THE INSIDE OF YOUR WASHER





- Fill your machine with hot water. Add about two cups of a powder detergent that contains phosphate.
- Let it rotate for several minutes.
- Stop the machine, drain the machine and run the machine through a regular cycle.
We do not recommend that you wash clothes during this procedure.

Look for your problem below, then check the things we suggest. More often than not, this will give you the answer to your problem. And you'll be able to carry on without having to telephone your service center.

WASH PROBLEM

Symptom	Possible Causes	What To Do
Lint or residue on clothes	<p>Incorrect sorting</p> <p>Washing too long</p>	<ul style="list-style-type: none"> ● Separate lint producers from lint collectors. ● Wash small loads for a shorter time than larger loads.
Detergent on clothes	Detergent not dissolving	<ul style="list-style-type: none"> ● Try using less detergent. ● Use warmer water temperature. ● Try pre-dissolving the detergent in warm water ● Try a liquid detergent.
Black spots on clothes	<p>Incorrect use of fabric softener</p> <p>Dye transfer</p>	<ul style="list-style-type: none"> ● When filling dispenser, do not splash or overfill. ● Never pour fabric softener directly on clothes. ● Pretreat stain and rewash. ● Sort whites or lightly colored items from dark colors. ● Wash and dry non-colorfast clothes separately.
Snags, holes, tears, rips or excessive wear	<p>Pins, snaps, hooks, sharp buttons, belt buckles, zippers, and sharp objects left in pockets</p> <p>Undiluted chlorine bleach</p>	<ul style="list-style-type: none"> ● Fasten snaps, hooks, buttons, and zippers. ● Remove any loose brassiere wires. ● Remove objects in pockets and sharp buttons. ● Turn knits (which snag easily) inside out. ● Check bleach package instructions for proper amount. ● Never add undiluted bleach to wash or allow clothes to come in contact with undiluted bleach.
The laundry comes out dirty	<p>Water temperature is too cold.</p> <p>Stain is not pretreated</p> <p>Washer is overloaded</p> <p>Incorrect sorting</p>	<ul style="list-style-type: none"> ● Use warmer water temperature. ● Brush a little detergent dissolved in water onto stains like collars and cuffs to help shift dirt. ● Wash stains as soon as possible. The longer they are left the harder they are to remove. ● Did you load too much into the machine? ● White clothes are better washed separately. ● Separate light and heavily soiled items.

Before calling for service, check the problem against the list below.

Symptom	Error Message	Check up
<p>Water Supply Failure</p> <p>If no water is inserted, “WASH”, “RINSE” indicators will blink.</p>		<ul style="list-style-type: none"> ● Is the water tap shut off? ● Is the water supply cut off? ● Is the tap or water supply hose frozen? ● Is the water pressure low or is the filter of the inlet valve clogged with impurities? ● Is the Hot/Cold selected to Hot when the hose connected to Cold? ● Is the Cold hose connected to Hot?
<p>Drainage Failure</p> <p>If no water is drained, “RINSE”, “SPIN” indicators will blink.</p>		<ul style="list-style-type: none"> ● Is the drain hose positioned correctly? ● Is the drain hose bent or placed too high? ● Is the internal part of the hose or drain pump (only pump model) clogged with impurities?
<p>Spin Failure</p> <p>If no spinning, “WASH”, “RINSE”, “SPIN” indicators will blink.</p>		<ul style="list-style-type: none"> ● Is the laundry evenly balanced? ● Is the washing machine placed on a flat surface?
<p>Door(Lid) Open</p> <p>If the lid is opened during spin cycles, “WASH”, “SPIN” indicators will blink.</p>		<ul style="list-style-type: none"> ● Is the lid closed?
<p>Internal sensing failure</p> <p>Power failure</p> <p>Overflow failure</p>		<ul style="list-style-type: none"> ● Ask for help at the LG Electronics branch of the Service Center.

S pecification

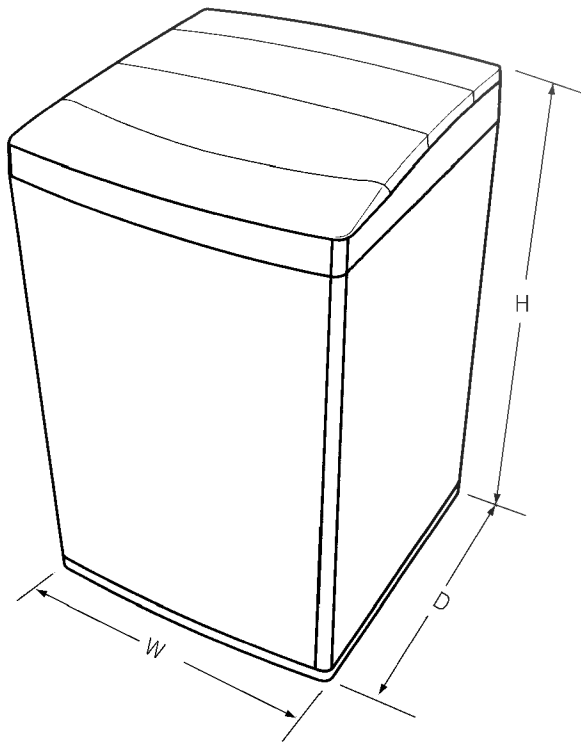

- ❑ ELECTRICITY SOURCE : On the Rating Label
- ❑ THE USE RANGE OF WATER PRESSURE : 0.3 ~ 10kgf/cm²(30-1000kPa)
WF - 5246TTC
- ❑ WEIGHT : 30Kg
- ❑ SIZE(mm) : 525(W) × 530(D) × 844(H)
- ❑ STANDARD WATER LEVEL : EX-LARGE : 48 ℓ
LARGE : 44 ℓ
MEDIUM : 37 ℓ
SMALL : 26 ℓ

