



website <http://www.lgservice.com>

LG

ENGLISH

LG Room Air Conditioner **OWNER'S MANUAL**

MODELS: SU/SZ Chassis

Prior to installation, this air-conditioning unit must be submitted for approval by the utility service which provides electricity (EN 61000-2, EN 61000-3 Norm).

IMPORTANT

Read the owner's manual carefully and thoroughly before installation and operation of the room air conditioner. This manual is the property of the owner and should be kept for future reference after installation. Read the manual thoroughly.

TABLE OF CONTENTS



FOR YOUR RECORDS

Write the model and serial numbers here:

Model # _____

Serial # _____

You can find them on a label on the side of each unit.

Dealer's Name _____

Date Purchased _____

■ Staple your receipt to this page in the event you need it to prove date of purchase or for warranty issues.



READ THIS MANUAL

Inside you will find many helpful hints on how to use and maintain your air conditioner properly. Just a little preventive care on your part can save you a great deal of time and money over the life of your air conditioner.

You'll find many answers to common problems in the chart of troubleshooting tips. If you review our chart of

Troubleshooting Tips first, you may not need to call for service at all.



PRECAUTION

- Contact the authorized service technician for repair or maintenance of this unit.
- Contact the installer for installation of this unit.
- The air conditioner is not intended for use by young children or invalids without supervision.
- Young children should be supervised to ensure that they do not play with the air conditioner.
- When the power cord is to be replaced, replacement work shall be performed by authorized personnel only using only genuine replacement parts.
- Installation work must be performed in accordance with the National Electric Code by qualified and authorized personnel only.

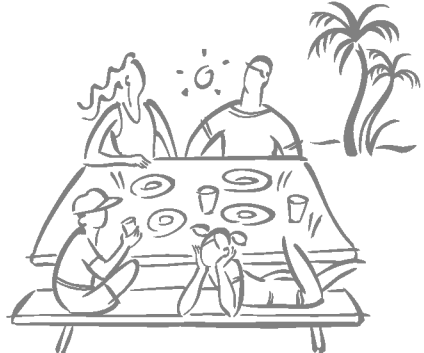

To prevent the injury of the user or other people and property damage, the following instructions must be followed.

- Incorrect operation due to ignoring instruction will cause harm or damage. The seriousness is classified by the following indications.

⚠ WARNING This symbol indicates the possibility of death or serious injury.

⚠ CAUTION This symbol indicates the possibility of injury or damage to properties only.

- The meanings of the symbols used in this manual are as shown below.

	Be sure not to do.
	Be sure to follow the instruction.

⚠ WARNING

■ Installation

Don't use a power cord, a plug or a loose socket which is damaged.

- Otherwise, it may cause electrical shock.

- Otherwise, it may cause a fire or electrical shock.

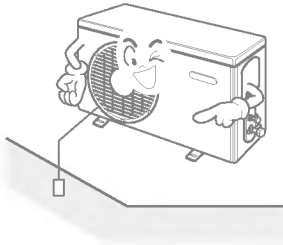

For installation of the product, always contact the service center or a professional installation agency.

- Otherwise, it may cause a fire, electrical shock, explosion or injury.

Securely attach the electrical part cover to the indoor unit and the service panel to the outdoor unit.

- If the electrical part cover of the indoor unit and the service panel of the outdoor unit are not attached securely, it could result in a fire or electric shock due to dust, water, etc.

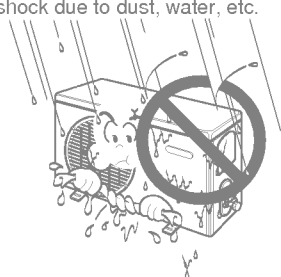
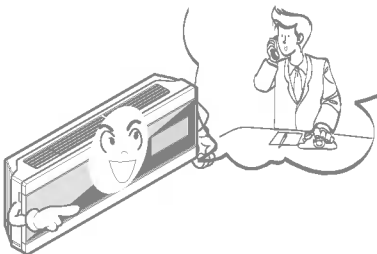

Always install an air leakage breaker and a dedicated switching board.

- No installation may cause a fire and electrical shock.

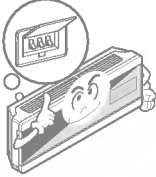

Do not keep or use flammable gases or combustibles near the air conditioner.

- Otherwise, it may cause a fire or the failure of product.

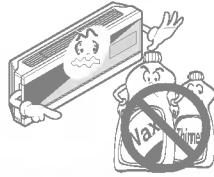

Ensure that an installation frame of the outdoor unit is not damaged due to use for a long time.

- It may cause injury or an accident.

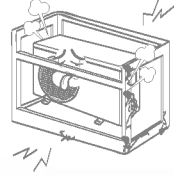

Do not disassemble or repair the product randomly.

- It will cause a fire or electrical shock.

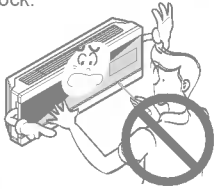

Do not install the product at a place that there is concern of falling down.

- Otherwise, it may result in personal injury.

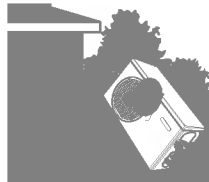

Use caution when unpacking and installing.

- Sharp edges may cause injury.

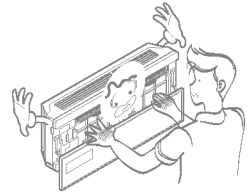

■ Operation

Do not share the outlet with other appliances.

- It will cause an electric shock or a fire due to heat generation.

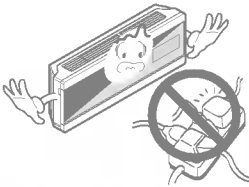

Do not use the damaged power cord.

- Otherwise, it may cause a fire or electrical shock.

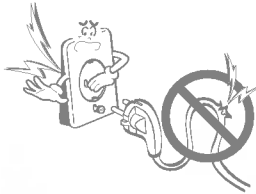

Do not modify or extend the power cord randomly.

- Otherwise, it may cause a fire or electrical shock.

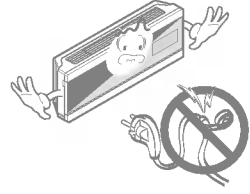

Take care so that the power cord may not be pulled during operation.

- Otherwise, it may cause a fire or electrical shock.

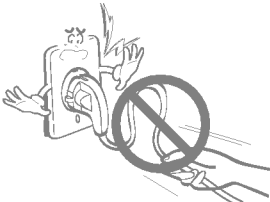

Unplug the unit if strange sounds, smell, or smoke comes from it.

- Otherwise, it may cause electrical shock or a fire.

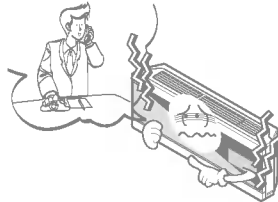

- Otherwise, it may cause a fire.

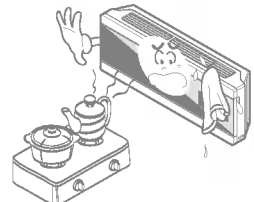

Take the power plug out if necessary, holding the head of the plug and do not touch it with wet hands.

- Otherwise, it may cause a fire or electrical shock.



Do not use the power cord near the heating tools.

- Otherwise, it may cause a fire and electrical shock.

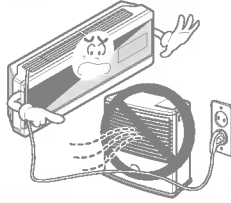

Do not open the suction inlet of the indoor/outdoor unit during operation.

- Otherwise, it may electrical shock and failure.

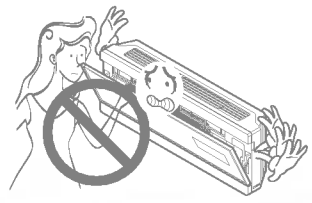

Do not allow water to run into electrical parts.

- Otherwise, it may cause the failure of machine or electrical shock.

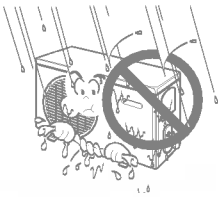

Hold the plug by the head when taking it out.

- It may cause electric shock and damage.

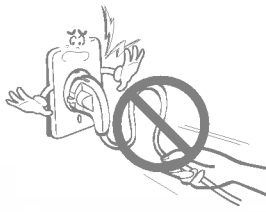

Never touch the metal parts of the unit when removing the filter.

- They are sharp and may cause injury.

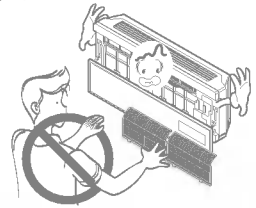

Ventilate the room well when using this appliance together with a stove, etc.

- An oxygen shortage may occur.

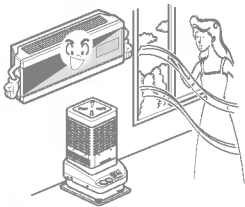

When cleaning the unit, first make sure the power and breaker are turned off.

- Otherwise, it may cause electrical shock.

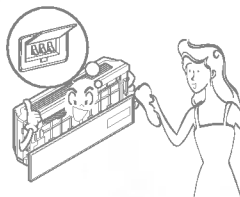

Turn off the main power switch when not using the product for a long time.

- Otherwise, it may cause the failure of product or a fire.

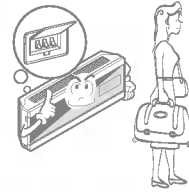

Do not step on the indoor/outdoor unit and do not put anything on it.

- It may cause an injury through dropping of the unit or falling down.



Do not place a heavy object on the power cord.

- Otherwise, it may cause a fire or electrical shock.

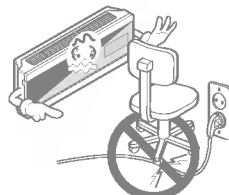

When the product is submerged into water, always contact the service center.

- Otherwise, it may cause a fire or electrical shock.



Take care so that children may not step on the outdoor unit.

- Otherwise, children may be seriously injured due to falling down.

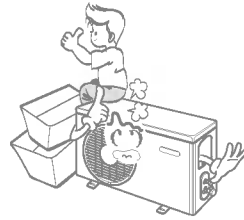

⚠ CAUTION

■ Installation

Install the drain hose to ensure that drain can be securely done.

- Otherwise, it may cause water leakage.

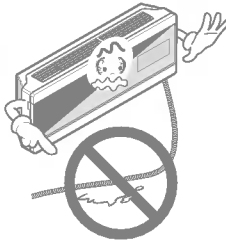

Install the product so that the noise or hot wind from the outdoor unit may not cause any damage to the neighbors.

- Otherwise, it may cause dispute with the neighbors.

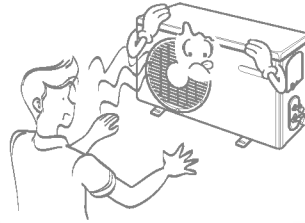

Always inspect gas leakage after the installation and repair of product.

- Otherwise, it may cause the failure of product.

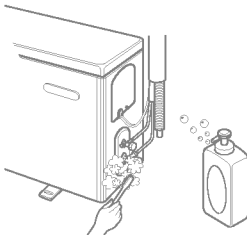

Keep level parallel in installing the product.

- Otherwise, it may cause vibration or water leakage.

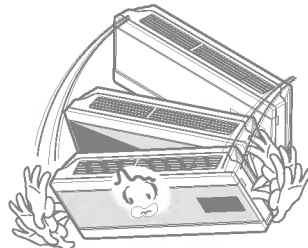

■ Operation

Avoid excessive cooling and perform ventilation sometimes.

- Otherwise, it may do harm to your health.

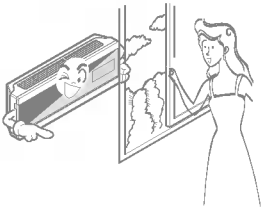

Use a soft cloth to clean. Do not use wax, thinner, or a strong detergent.

- The appearance of the air conditioner may deteriorate, change color, or develop surface flaws.

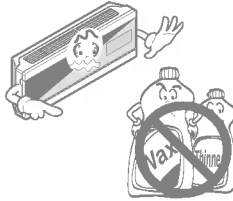

When gas leaks, open the window for ventilation before operating the unit.

- Otherwise, it may cause explosion, and a fire.

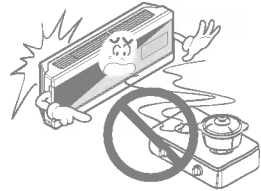

Do not use an appliance for special purposes such as preserving animals, vegetables, precision machine, or art articles.

- Otherwise, it may damage your properties.

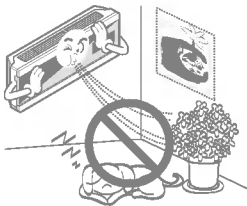

Do not place obstacles around the flow inlet or outlet.

- Otherwise, it may cause the failure of appliance or an accident.

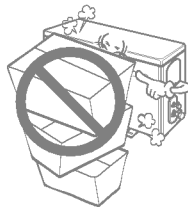

Always insert the filter securely. Clean it every two weeks.

- Operation without the filter will cause failure.

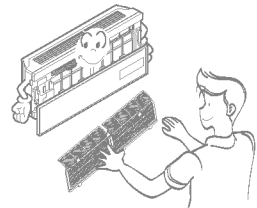

Do not insert the hands or bars through the air inlet or outlet during operation.

- Otherwise, it may cause personal injury.

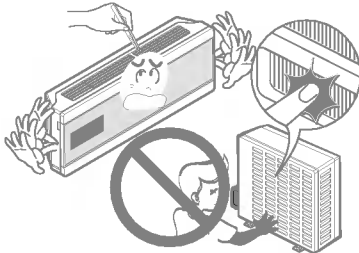

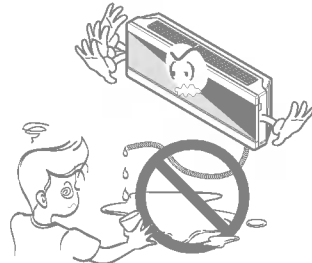

Do not drink water coming out of the air conditioner.

- Otherwise, it may cause stomachache.



- 
- 
1. Contact an installation specialist for installation.
 2. Plug in the power plug properly.
 3. Use a dedicated circuit.
 4. Do not use an extension cord.
 5. Do not start/stop operation by plugging/unplugging the power cord.
 6. If the cord/plug is damaged, replace it with only an authorized replacement part.

- 
1. Being exposed to direct airflow for a long time may be hazardous to your health. Do not expose occupants, pets, or plants to direct airflow for a long time.
 2. Due to the possibility of oxygen deficiency, ventilate the room when using the appliance together with stoves or other heating devices.
 3. Do not use this air conditioner for non-specified special purpose (e.g. preserving precision devices, food, pets, plants, or art objects). Such use may damage your properties.

- 
1. Do not touch the metal parts of the unit when removing the filter. Injury can occur.
 2. Do not use water to clean inside the air conditioner. Exposure to water can destroy the insulation, leading to electric shock.
 3. When cleaning the unit, first make sure that the power and breaker are turned off. The fan rotates at a very high speed during operation. There is a possibility of injury if the unit's power is triggered while cleaning inner parts of the unit.



For repair and maintenance, contact your authorized service dealer.



This symbol alerts you to the risk of electric shock.



This symbol alerts you to hazards that may cause harm to the air conditioner.

This symbol indicates special notes.



WARNING: This appliance should be installed in accordance with national wiring regulations. This guide acts as a guide to help to explain product features.

Indoor

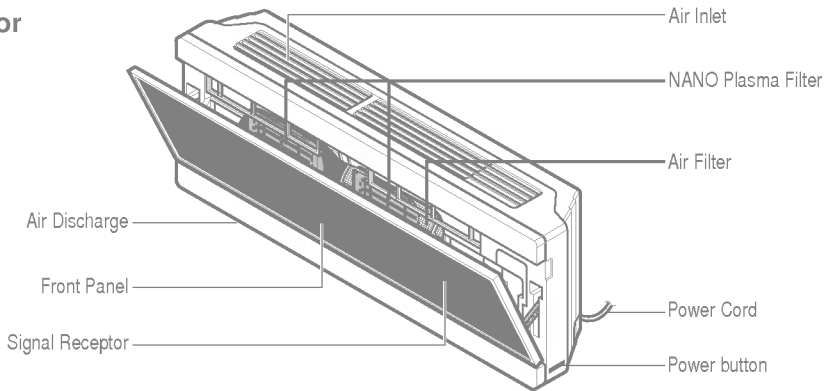

Outdoor

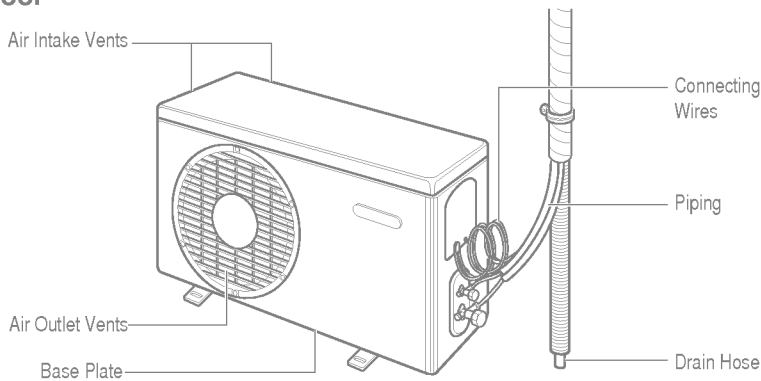



WARNING: This appliance must be properly grounded.

To minimize the risk of electric shock, you must always plug into a grounded outlet.

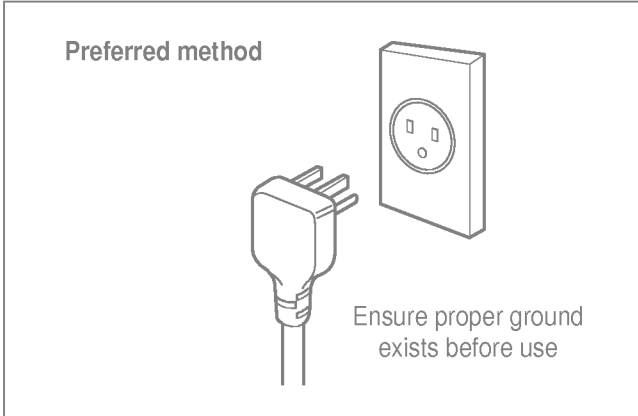

WARNING: Do not cut or remove the grounding prong from the power plug.



WARNING: Attaching the adapter ground terminal to the wall receptacle cover screw does not ground the appliance unless the cover screw is metal and not insulated, and the wall receptacle is grounded through the house wiring.



WARNING: If you have any doubt whether the air conditioner is properly grounded, have the wall receptacle and circuit checked by a qualified electrician.

We **strongly discourage** the use of an adapter due to potential safety hazards. For temporary connections, use only a UL-listed adapter, available from most local hardware stores. Ensure that the large slot in the adapter is aligned with the large slot in the receptacle for a proper polarity connection. To disconnect the power cord from the adapter, use one hand on each to avoid damaging the ground terminal. Avoid frequently unplugging the power cord as this can lead to eventual ground terminal damage.

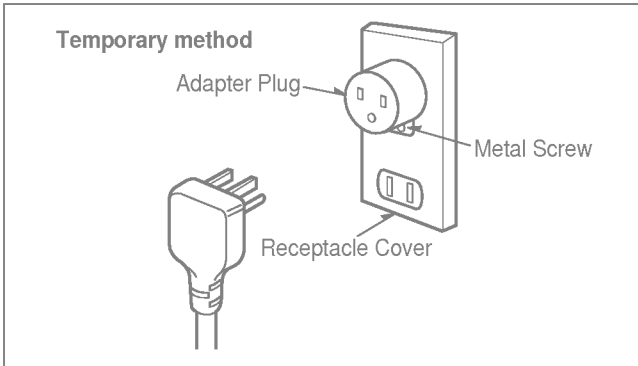

WARNING: Never use the appliance with a broken adapter.

We strongly discourage the use of an extension cord due to potential safety hazards. For temporary situations, use only CSA certified and UL listed 3-wire grounded extension cords, rated 15 A, 125 V.

1. Remove the battery cover by pulling it according to the arrow direction.
2. Insert new batteries making sure that the (+) and (-) of battery are installed correctly.
3. Reattach the cover by sliding it back into position.

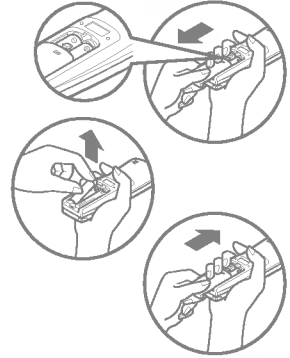

Use 2 AAA(1.5volt) batteries.
Do not use rechargeable batteries.



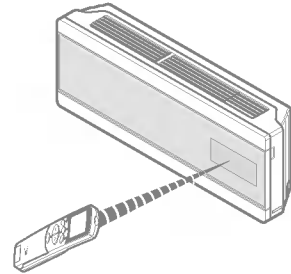
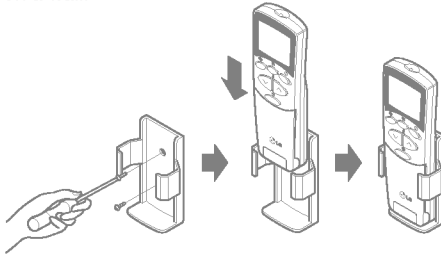

- The remote controller may be stored by mounting it on a wall.
- To operate the room air conditioner, aim the remote controller at the signal receptor.



Signal receptor

Receives the signals from the remote controller.(Signal receiving sound: two short beeps or one long beep.)

Operation indicating lamps

- | | | |
|---|------------------------|---|
|  | On/Off | : Lights up during the system operation. |
|  | Sleep Mode | : Lights up during Sleep Mode Auto operation. |
|  | Timer | : Lights up during Timer operation. |
|  | Defrost Mode | : Lights up during Defrost Mode or Hot Start operation (Heat pump model only) |
|  | Outdoor Unit Operation | : Lights up during outdoor unit operation. (Cooling model only) |

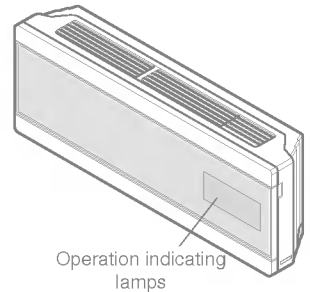

PLASMA Nano Plasma : The function illustrates its dynamic mode by using a multiple lighting system.

The controls will look like the following.

Controls

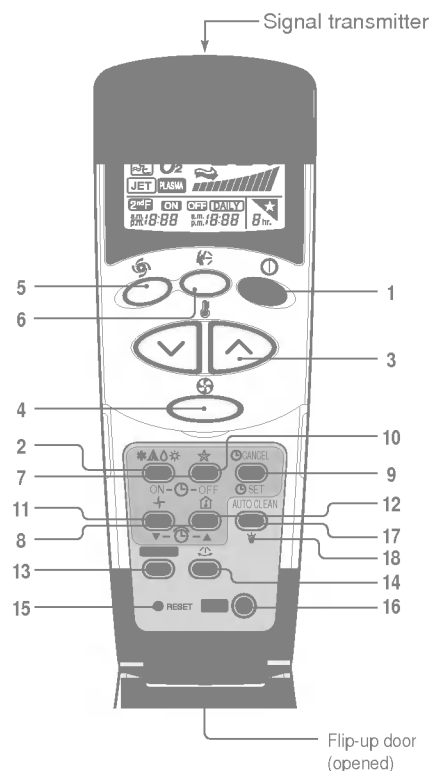

1. START/STOP BUTTON

Operation starts when this button is pressed and stops when the button is pressed again.



2. OPERATION MODE SELECTION BUTTON

Used to select the operation mode.



3. ROOM TEMPERATURE SETTING BUTTONS

Used to select the room temperature.



4. INDOOR FAN SPEED SELECTOR

Used to select fan speed in four steps low, medium, high and CHAOS.



5. JET COOL

Used to start or stop the speed cooling. (speed cooling operates super high fan speed in cooling mode.)



6. CHAOS SWING BUTTON

Used to stop or start louver movement and set the desired up/down airflow direction.



7. ON/OFF TIMER BUTTONS

Used to set the time of starting and stopping operation. (See page 22)

8. TIME SETTING BUTTONS

Used to adjust the time. (See page 22)

9. TIMER SET/CANCEL BUTTON

Used to set the timer when the desired time is obtained and to cancel the Timer operation. (See page 22)

10. SLEEP MODE AUTO BUTTON

Used to set Sleep Mode Auto operation. (See page 22)

11. AIR CIRCULATION BUTTON

Used to circulate the room air without cooling or heating. (See page 23)

12. ROOM TEMPERATURE CHECKING BUTTON

Used to check the room temperature.

13. NANO PLASMA(OPTIONAL)

Used to start or stop the plasma-purification function. (See page 20)

14. HORIZONTAL AIRFLOW DIRECTION CONTROL BUTTON (OPTIONAL)

Used to set the desired horizontal airflow direction.

15. RESET BUTTON

Used prior to resetting time.

16. 2nd F Button

Used prior to using modes printed in blue at the bottom of buttons. (See page 21)

17. AUTO CLEAN (OPTIONAL)

Used to set Auto Clean mode.

18. LED LUMINOSITY (OPTIONAL)

Used to adjust LED luminosity.

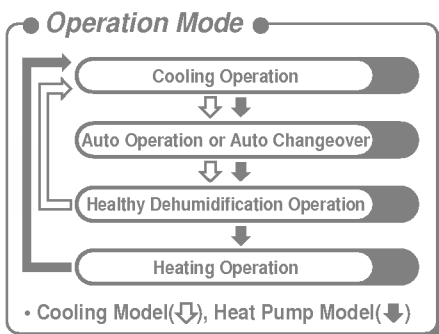

Cooling operation

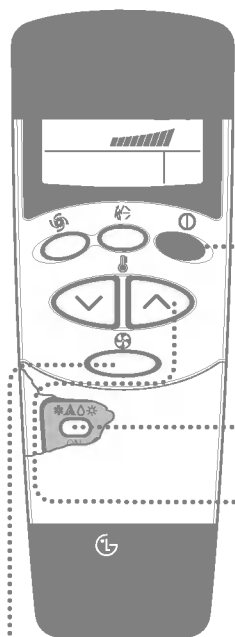

- 1** Press the Start/Stop button.
The unit will respond with a beep.



- 2** Open the door of the remote controller. To select **Cooling Operation**, press the Operation Mode Selection button. Each time the button is pressed, the operation mode is shifted in the direction of the arrow.

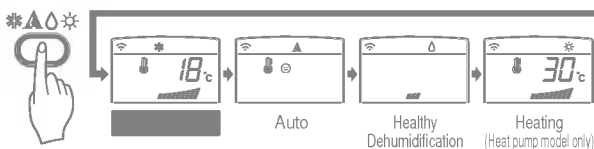

- 3** Close the door of the remote controller. Set the temperature lower than the room temperature. The temperature can be set within a range of 18°C~30°C at intervals of 1°C.

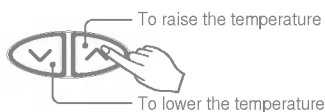

- 4** Set the fan speed again with the door of the remote controller still closed. You can select the fan speed in four steps-low, medium, high and CHAOS. Each time the button is pressed, the fan speed mode is shifted.



Natural wind by the CHAOS logic

- For fresher feeling, press the Indoor fan speed selector and set to CHAOS mode. In this mode, the wind blows like a natural breeze by automatically changing fan speed according to the CHAOS logic.

A Auto operation (Cooling model only)

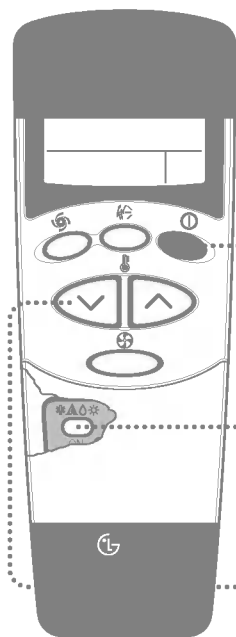

- 1** Press the Start/Stop button.
The unit will respond with a beep.



- 2** Open the door of the remote controller. To select **Auto Operation**, press the operation mode selection button. Each time the button is pressed, the operation mode is shifted in the direction of the arrow.

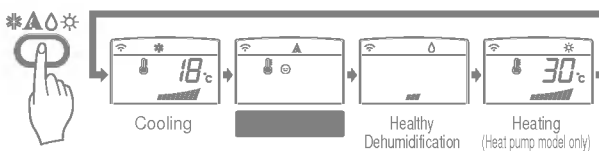

- 3** The temperature and fan speed are automatically set by the electronic controls based on the actual room temperature. If you want to change the set temperature, press the Room Temperature Setting buttons. The cooler or warmer you feel, the more times (up to two times) you should press the button. The set temperature will be changed automatically.

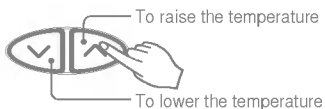

During Auto Operation

- You cannot control the indoor fan speed. It has already been set by the Fuzzy rule.
- If the system is not operating as desired, manually switch to another mode. The system will not automatically switch from the cooling mode to the heating mode, or from heating mode to cooling mode, it must be done by manually resetting.
- During Auto Operation, pressing the chaos swing button makes the horizontal louvers swing up and down automatically. If you want to stop auto-swing, press the chaos swing button again.

A Auto changeover operation(Heat pump model only)



- 1** Press the Start/Stop button.
The unit will respond with a beep.



- 2** Open the door of the remote controller. To select **Auto Changeover Operation**, press the Operation Mode Selection button. Each time the button is pressed, the operation mode is shifted in the direction of the arrow.

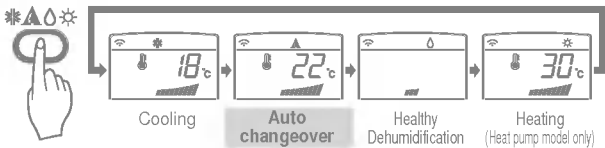

- 3** Close the door of the remote controller. Set the temperature lower than the room temperature. The temperature can be set within a range of 18°C~30°C at intervals of 1°C.

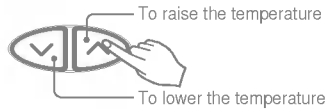

- 4** Set the fan speed again with the door of the remote controller still closed. You can select the fan speed in four steps-low, medium, high and CHAOS. Each time the button is pressed, the fan speed mode is shifted.



During Auto changeover Operation

The air conditioner changes the operation mode automatically to keep indoor temperature. When room temperature vary over $\pm 2^{\circ}\text{C}$ with respect to setting temperature, air conditioner keeps the room temperature within $\pm 2^{\circ}\text{C}$ with respect to setting temperature by auto changeover mode.

Healthy dehumidification operation

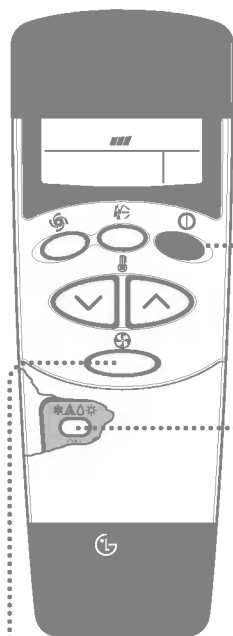

- 1** Press the Start/Stop button. The unit will respond with a beep.



- 2** Open the door of the remote controller. To select **Healthy Dehumidification Operation**, press the Operation Mode Selection button. Each time the button is pressed, the operation mode is shifted in the direction of the arrow.

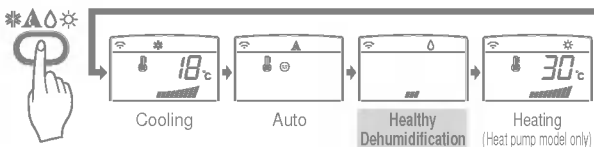

- 3** Set the fan speed again with the door of the remote controller still closed. You can select the fan speed in four steps—low, medium, high, or CHAOS. Each time the button is pressed, the fan speed mode is shifted.



Natural wind by the CHAOS logic

- For fresher feeling, press the Indoor Fan Speed Selector and set to CHAOS mode. In this mode, the wind blows like a natural breeze by automatically changing fan speed according to the CHAOS logic.

During Healthy Dehumidification Operation

- If you select the dehumidification mode on the operation selection button, the A/C starts to run the dehumidification function. It automatically sets the room temp. and airflow volume to the best condition for dehumidification, based on the sensed current room temp.

In this case, however, the setting temp. is not displayed on the remote controller and you are not able to control the room temp. either.

- During the healthy dehumidification function, the airflow volume is automatically set according to the optimization algorithm responding to the current room temp. status, so that the room condition is kept healthy and comfortable even in the very humid season.

Heating operation (Heat pump model only)

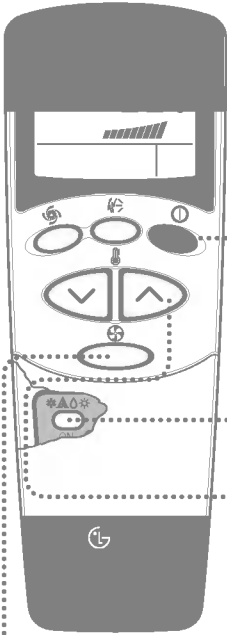

- 1** Press the Start/Stop button.
The unit will respond with a beep.

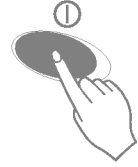

- 2** Open the door of the remote controller. To select **Heating Operation**, press the Operation Mode Selection button. Each time the button is pressed, the operation mode is shifted in the direction of the arrow.

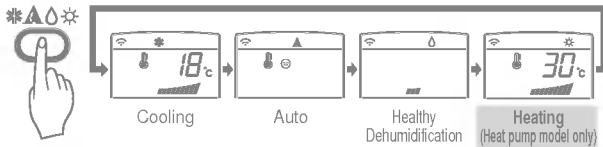

- 3** Close the door of the remote controller. Set the temperature higher than the room temperature. The temperature can be set within a range of 16°C~30°C at intervals of 1°C.

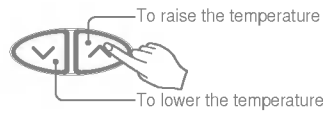

- 4** Set the fan speed again with the door of the remote controller still closed. You can select the fan speed in four steps—low, medium, high and CHAOS. Each time the button is pressed, the fan speed mode is shifted.

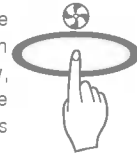

Natural wind by the CHAOS logic

- For fresher feeling, press the Indoor Fan Speed Selector and set to CHAOS mode. In this mode, the wind blows like a natural breeze by automatically changing fan speed according to the CHAOS logic.

Jet cool operation

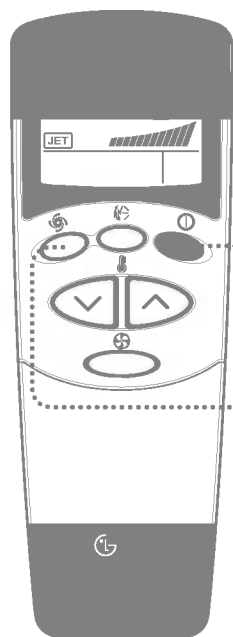

- 1** Press the Start/Stop button.
The unit will respond with a beep.



- 2** Press the **Jet Cool** button to operate the speed cooling mode and the unit will operate at super high fan speed on cooling mode for 30 minutes.



- 3** To cancel the **Jet Cool** mode, press the **Jet Cool** button, the fan speed button or the room temperature setting button again and the unit will operate at high fan speed on cooling mode.

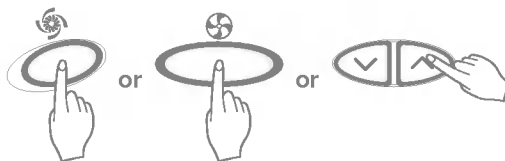

- During the JET COOL function at any moment, the A/C starts to blow the cool air at extremely high speed for 30 minutes setting the room temp. automatically to 18°C. It is especially used to cool the room temp. quickly in a hot summer.

In heat pump mode or neuro fuzzy mode, however, the JET COOL function is not available.

- In order to return to the normal cooling mode from the JET COOL mode, just press the operation mode selection button, airflow volume selection, temp. setting button or the JET COOL button again.

NANO PLASMA purification operation(Optional)

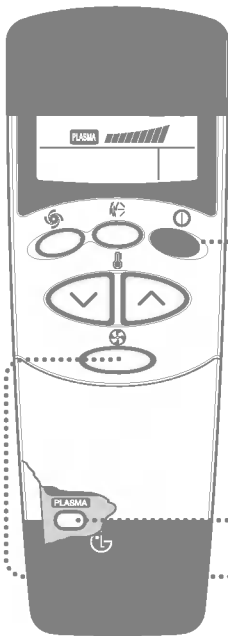

- 1** Press the Start/Stop button. The unit will respond with a beep.

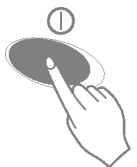

- 2** Open the door of the remote controller. Press the NANO PLASMA button. Operation will start when the button is pressed and stop when the button is pressed again.

- 3** Set the fan speed again with the door of the remote controller closed. You can select the fan speed in four steps-low, medium, high or CHAOS. Each time the button is pressed, the fan speed mode is shifted.

* Air purifying operation (NANO PLASMA) can be with cooling, Heating or any other operations.

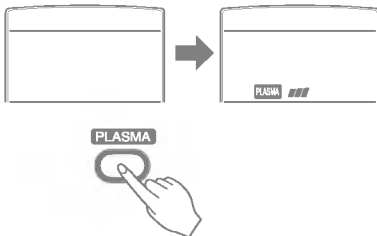

NANO PLASMA Air Purifying Operation only



If you press the only NANO PLASMA button, only NANO PLASMA purification function operates.

Then, fan speed is low. You can select the fan speed in four steps-low, medium, high or CHAOS.

Each time the button () is pressed, the fan speed mode is shifted.

2nd F 2nd F operation

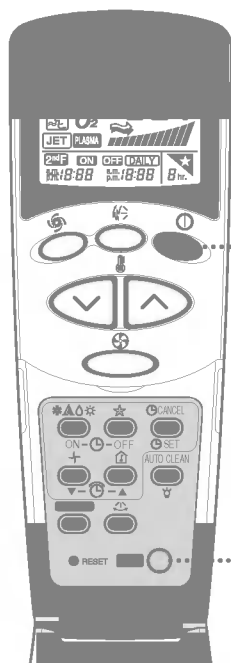

- 1** Press the Start/Stop button.
The unit will respond with a beep.



- 2** Open the door of the remote control and press the 2nd Function button to operate functions printed in blue under buttons.
(Check the indication of 2nd function on the display of the remote controller.)
These buttons can set the timer as follows:

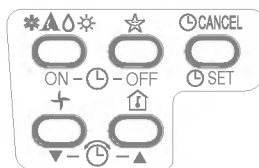

- 3** 2nd function disappears in a short time automatically or when the button is pressed again.

For more details, refer to functions next pages.

★ Sleep mode



1. Press the Sleep Mode Auto button to set the time you want the unit to stop automatically. 
2. The Timer is programmed in one-hour increments by pressing the Sleep Mode Auto button 1 to 7 times. The sleep mode is available for 1 to 7 times. To alter the time period in steps of 1 hour, press the Sleep Mode Button while aiming at air conditioner.
3. Make sure the Sleep Mode Auto LED lights up.
To cancel the Sleep Mode, press the sleep Mode Auto button several times until the star (★) disappears from the operation display.

The Sleep Mode will be operated at slow fan speed (cooling) or medium fan speed (heat pump only) for a comfortable sleep.

In cooling mode or healthy dehumidification mode:



The temperature will automatically rise by 1°C over the next 30 minutes and by 2°C in 1 hour for a comfortable sleep.

🕒 Setting the time

1. Time can be set only when you press the Reset button. Having replacing the batteries, you should press the reset buttons to reset the time. Press the Start/Stop button. 
2. Press 2nd F button and check if 2nd F icon is on.
3. Press the Time Setting buttons until the desired time is set. 
4. Press the Timer SET button. 

Check the indicator for A.M. and P.M.

🕒 Delay start/Pre-set stop

1. Make sure the time is set correctly on the display of the remote controller.
2. Press 2nd F button.
3. Press the ON/OFF Timer buttons to turn Timer on or off. 
4. Press the Time Setting buttons until the desired time is set. 
5. To set the selected time, press the Timer setting button aiming the remote controller at the signal receptor. 

To cancel the timer setting

Check if 2nd F icon is off.

Press the Timer Cancel button aiming the remote controller at the signal receptor. (The timer lamp on the air conditioner and the display will go out.) 

Select one of the following four types of operation.

with the unit running



Delay OFF Timer



Delay ON Timer



Delay OFF and ON Timer



Delay ON and OFF Timer

Vertical Airflow Direction Control

The up/down airflow (Vertical Airflow) can be adjusted by using the remote control.

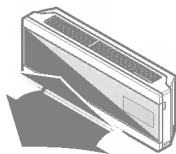

1. Press the Start/Stop button to start the unit.
2. Press Chaos Swing button and the louvers will swing up and down. Press the Chaos Swing button again to set the vertical louver at the desired airflow direction.



- If you press the CHAOS swing button, the horizontal airflow direction is changed automatically based on the CHAOS algorithm to distribute the air in the room evenly and at the same time to make the human body feel most comfortable, as if enjoying a natural breeze.
- Always use the remote control to adjust the up/down airflow direction. Manually moving the vertical airflow direction louver by hand, could damage the air conditioner.
- When the unit is shut off, the up/down airflow direction louver will close the air outlet vent of the system.

Horizontal Airflow Direction Control (Optional)

The left/right(Horizontal Airflow) can be adjusted by using the remote control. Press the Start/Stop button to start the unit.

Open the door on the remote control. Press the Airflow Direction Start/Stop button and the louvers will swing left and right. Press the Horizontal Airflow Direction Control Button again to set the horizontal louver at the desired airflow direction.

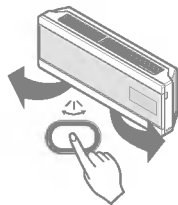

Air circulation mode

Circulates the room air without cooling or heating.

1. Press the Start/Stop button. the unit will respond with a beep.
2. Open the door on the remote control. Press the Air Circulation button. Close the door on the remote control. Now each time that you press the Indoor Fan Speed Selector, the fan speed is shifted from low to CHAOS and back to low again.

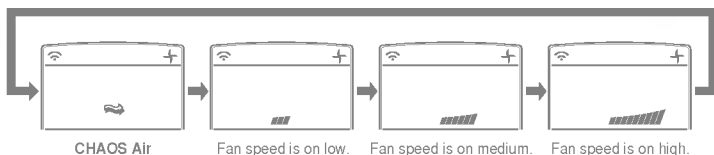

CHAOS Air economizes power consumption and prevents overcooling. The fan speed is automatically changed from high to low or vice versa, depending on the ambient temperature.

Auto clean (Optional)



1. Whenever you press the Auto Clean button, Auto Clean Function will be reserved and cancelled.
2. Auto Clean function works before and after cooling or dehumidification mode. For details, refer to the below points.
3. When the unit is started after the reservation of Auto Clean ,the Cool Start function operates and indoor Fan is started after 20 seconds.
4. When you press Start/Stop button to turn off the unit after the you have reserved Auto Clean function, the air-conditioner circulates the indoor air in the Auto Clean mode with no more Cooling or Dehumidification operation. For Cooling only model, it lasts for 30 minutes for Heat pump model, for 16 minutes.
5. If you press the auto clean button again during the product operation , Auto Clean function will be cancelled.

- During Auto Clean function, moistures left in indoor units after Cooling Operation or Healthy Dehumidification Operation can be removed.
- During Auto Clean function, only Start/Stop button, Plasma button and Auto Clean button are available.

Display Luminosity (Optional)

- The Display Luminosity can be adjusted by using the remote control. Press the start/stop button to start the unit. Open the door on the remote control, press the 2ndF button and, press display luminosity button. Display will be dark. Press the button again to set bright display.

Forced operation

Operation procedures when the remote control can't be used.
The operation will be started if the power button is pressed.
If you want to stop operation, re-press the button.

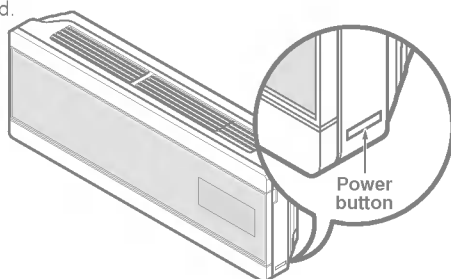

	Cooling Model	Heat pump Model		
		Room Temp. $\geq 24^{\circ}\text{C}$	$21^{\circ}\text{C} \leq$ Room Temp. $< 24^{\circ}\text{C}$	Room Temp. $< 21^{\circ}\text{C}$
Operating mode	Cooling	Cooling	Healthy Dehumidification	Heating
Indoor FAN Speed	High	High	High	High
Setting Temperature	22°C	22°C	23°C	24°C

Test operation

During the TEST OPERATION, the unit operates in cooling mode at high speed fan, regardless of room temperature and resets in 18 minutes.

During test operation, if remote controller signal is received, the unit operates as remote controller sets.

If you want to use this operation, open the front panel upward and Press the power button let it be pressed for about 3 seconds.

If you want to stop the operation, re-press the button.

Auto restart

In case the power comes on again after a power failure, Auto Restarting Operation is the function to operate procedures automatically to the previous operating conditions.

So there is no need of activating this function by pressing any key or button.

In the initial mode, the fan operates at a low speed and the compressor starts 2.5~3 minutes later.

As the compressor starts, the fan speed also resumes its previous setting mode.

Helpful information

Fan speed and cooling capacity.

The cooling capacity indicated in the specification is the value when the fan speed is set to high, and the capacity will be lower at low or medium fan speed.

High fan speed is recommended when you wish to cool the room quickly.

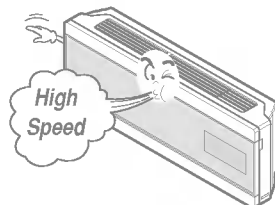



WARNING: Turn the system off before cleaning.
To clean, wipe with a soft, dry cloth. Do not use bleach or abrasives.

Supply power must be disconnected before cleaning the indoor unit.

1. Open the upside of Front Panel

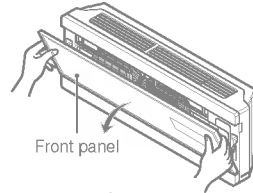

2. Put up the Front panel.
The hook of panel comes off.

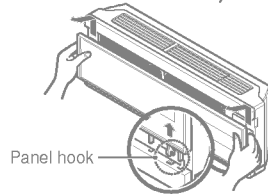

3. Come down the panel and then remove the air filter.



WARNING: Don't touch the PLASMA Filter within 10 seconds after opening the inlet grille, it may cause electric shock.

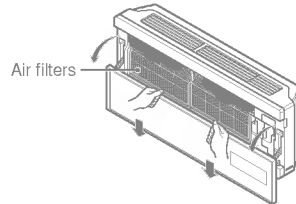

4. Clean it with a soft brush and the vacuum cleaner.
If it is very dirty, wash it with water.

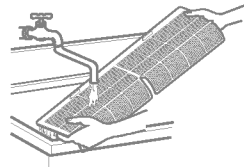

5. Reinstall the air filter dried at the shade and then close the panel.

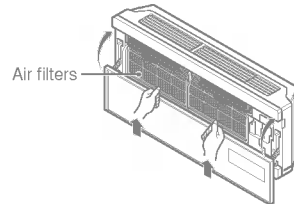

❑ Never use any of the followings:

- Water hotter than 40°C
Could cause deformation and/or discoloration.
- Volatile substances
Could damage the surfaces of the air conditioner.



The heat exchanger coils and panel vents of the outdoor unit should be checked regularly. If clogged with dirt or soot, the heat exchanger and panel vents may be professionally steam cleaned.

Dirty or clogged coils will reduce the operating efficiency of the system and cause higher operating costs.

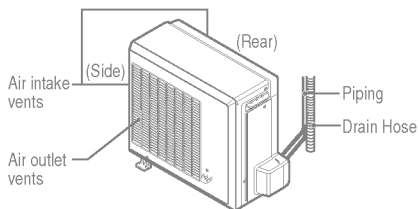
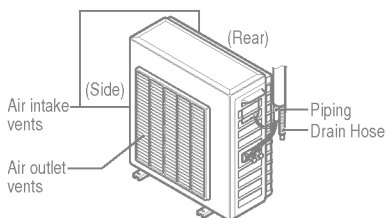
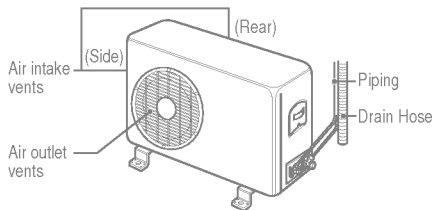

• Recommended use period : About 3 months

1. Open the upside of Front panel.

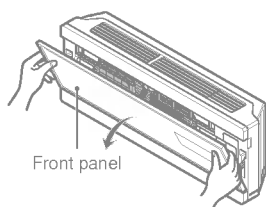

2. Put up the front panel. The hook of panel comes off.

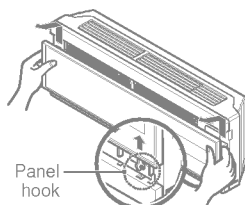

3. Remove air filter and then pull out the nano plasma filter.

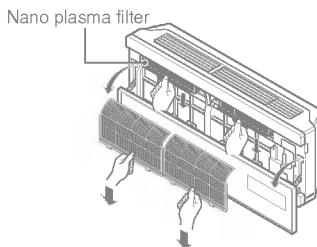

4. Clean nano plasma filter with the vacuum cleaner.

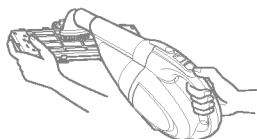

5. Relocate dried nano plasma filter at the shade and then put in air filter.

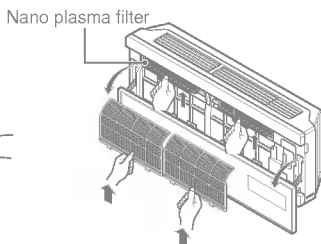



Before calling for service

If you have problems with your air conditioner, read the following information and try to solve the problem. If you cannot find a solution, turn off the air conditioner and contact your dealer.

Air conditioner does not operate

1. Ensure that the air conditioner is plugged into a proper outlet.
2. Check the fuse or circuit breaker.
3. Check whether the voltage is unusually high or low.

Air does not feel cold enough on the cooling setting

1. Ensure that the temperature settings are correct.
2. Check to see if the air filter is clogged with dust. If so, replace the filter.
3. Ensure that the air flow from the outside is not obstructed and that there is a clearance of over 20" between the back of the air conditioner and the wall or fence behind it.
4. Close all doors and windows and check for any source of heat in the room.



Before calling for service, please review the following list of common problems and solutions.

The air conditioner is operating normally when:

- You hear a pinging noise. This is caused by water being picked up by the fan on rainy days or in highly humid conditions. This feature is designed to help remove moisture in the air and improve cooling efficiency.
- You hear the thermostat click. This is caused by the compressor cycle starting and stopping.
- You see water dripping from the rear of the unit. Water may be collected in the base pan in highly humid conditions or on rainy days. This water overflows and drips from the rear of the unit.
- You hear the fan running while the compressor is silent. This is a normal operational feature.

The air conditioner may be operating abnormally when:

Air conditioner does not start	<ul style="list-style-type: none"> ■ The air conditioner is unplugged. ■ The fuse is blown/circuit breaker is tripped. ■ Power failure. 	<ul style="list-style-type: none"> • Make sure the air conditioner plug is pushed completely into the outlet. • Check the house fuse/circuit breaker box and replace the fuse or reset the breaker. • If power failure occurs, turn the mode control to Off. When power is restored, wait 3 minutes to restart the air conditioner to prevent tripping of the compressor overload.
Air conditioner does not cool as it should	<ul style="list-style-type: none"> ■ Airflow is restricted. ■ The thermostat may not be set high enough. ■ The air filter is dirty. ■ The room may have been hot. ■ Cold air is escaping. ■ Cooling coils have iced up. 	<ul style="list-style-type: none"> • Make sure there are no curtains, blinds, or furniture blocking the front of the air conditioner. • Turn the knob to a higher number. The highest setting provides maximum cooling. • Clean the filter at least every 2 weeks. See the care and Maintenance section. • When the air conditioner is first turned on, you need to allow time for the room to cool down. • Check for open furnace floor registers and cold air returns. • See Air Conditioner Freezing Up below.
Air conditioner freezing up	<ul style="list-style-type: none"> ■ Ice blocks the air flow and stops the air conditioner from cooling the room. 	<ul style="list-style-type: none"> • Set the mode control at High Fan or High Cool with thermostat at 1 or 2.

* You can refer to the Energy Star program in detail at www.energystar.gov.

