



# DVD PLAYER/ Hi-Fi STEREO VIDEO CASSETTE PLAYER

## OWNER'S MANUAL

MODEL : VLC8600P



Before connecting, operating or adjusting this product,  
please read this instruction booklet carefully and  
completely.

## Safety Precautions/Important notes on controlling this unit



**CAUTION**  
RISK OF ELECTRIC SHOCK  
DO NOT OPEN



**CAUTION:** TO REDUCE THE RISK OF ELECTRIC SHOCK DO NOT REMOVE COVER (OR BACK) NO USER-SERVICEABLE PARTS INSIDE REFER SERVICING TO QUALIFIED SERVICE PERSONNEL.



This lightning flash with arrowhead symbol within an equilateral triangle is intended to alert the user to the presence of uninsulated dangerous voltage within the product's enclosure that may be of sufficient magnitude to constitute a risk of electric shock to persons.



The exclamation mark within an equilateral triangle is intended to alert the user to the presence of important operating and maintenance (servicing) instructions in the literature accompanying the product.

**WARNING:** TO REDUCE THE RISK OF FIRE OR ELECTRIC SHOCK, DO NOT EXPOSE THIS PRODUCT TO RAIN OR MOISTURE.

CLASS 1 LASER PRODUCT  
KLASSE 1 LASER PRODUKT  
LUOKAN 1 LASER LAITE  
KLASS 1 LASER APPARAT  
CLASSE 1 PRODUIT LASER

### CAUTION:

This Digital Video Disc Player employs a Laser System.

To ensure proper use of this product, please read this owner's manual carefully and retain for future reference, should the unit require maintenance, contact an authorized service location-see service procedure.

Use of controls, adjustments or the performance of procedures other than those specified herein may result in hazardous radiation exposure.

To prevent direct exposure to laser beam, do not try to open the enclosure. Visible laser radiation when open. DO NOT STARE INTO BEAM.

**CAUTION:** The apparatus shall not be exposed to water, dripping or splashing and that no objects filled with liquids, such as vases, shall be placed on the apparatus.



This product is manufactured to comply with the radio interference requirements of EEC DIRECTIVE 89/336/EEC, 93/68/EEC and 73/23/EEC.



### Notes on copyrights:

It is forbidden by law to copy, broadcast, show, broadcast via cable, play in public, or rent copyright material without permission.

This product features the copy protection function developed by Macrovision. Copy protection signals are recorded on some discs.

This product incorporates copyright protection technology that is protected by method claims of certain U.S. patents and other intellectual property rights owned by Macrovision Corporation and other rights owners. Use of this copyright protection technology must be authorized by Macrovision Corporation, and is intended for home and other limited viewing uses only unless otherwise authorized by Macrovision Corporation. Reverse engineering or disassembly is prohibited.

**SERIAL NUMBER:** The serial number is found on the back of this unit. This number is unique to this unit and not available to others.

Model No. \_\_\_\_\_

Serial No. \_\_\_\_\_

### Features:

- Complete versatility to play DVD, VCDs, audio CDs or VHS Tapes.
- Watch a DVD while recording a TV show to the VCR.
- Remote controls both DVD and VCR decks.
- Records from DVD to VHS (unless DVD is copy protected with Macrovision).
- Hi-Fi Stereo VCR.

## Important notes on controlling this unit

This unit uses one set of controls to operate both DVD and VCR. The following buttons are helpful in successfully controlling each part.

### 1 POWER Button

Press the POWER button on the remote control or front panel to turn on this unit.

### 2 DVD Button

Press DVD button on the remote control when you want to control the DVD.

The DVD indicator will light on the front panel display to show that the DVD is selected.

### 3 VCR Button

Press the VCR button on the remote control when you want to control the VCR.

The VCR indicator will light on the front panel display to show that the VCR is selected.

### 4 DVD/VCR Button

Press the DVD/VCR button on the front panel to toggle control between the DVD and the VCR.

# Contents

## Introduction

Safety Precautions	2
Important notes on controlling this unit	2
Table of Contents	3
Before Use	4-5
Playable Discs	4
Precautions	5
Notes on Discs	5
About Symbols	5
Front Panel and Display Window	6
Remote Control	7
Rear Panel	8

## Preparation

Connections	9-10
Connecting to a TV	9
Connecting to Optional Equipment	10
Before Operation - VCR part	11
Setting the clock Manually	11
To set the colour system	11
How to using the main menu	11
Before Operation - DVD part	12-15
General Explanation	12
On-Screen Display	12
Initial Settings	13-15
• Initial Settings General Operation	13
• Language	13
• Picture	13
• Sound	14
• Others	14
• Parental Control	15

## Operation

Operation with Tape	16-17
Playing a tape	16
• CM (Commercial Message) Skip	16
• OPR (Optimum Picture Response)	16
Recording	17
Operation with DVD and Video CD	18-20
Playing a DVD and Video CD	18
General Features	18
• Moving to another TITLE	18
• Moving to another CHAPTER/TRACK	18
• Slow Motion	18
• Still Picture and Frame-by-Frame Playback	19
• Search	19
• Random	19
• Repeat	19
• Repeat A-B	19
• Time Search	19
• 3D Surround	19
• Zoom	20
• Marker Search	20
Special DVD Features	20
• Title Menu	20
• Disc Menu	20
• Camera Angle	20
• Changing the Audio Language	20
• Changing the Audio Channel	20
• Subtitles	20

## Operation with Audio CD and MP3/WMA Disc

Playing an Audio CD and MP3/WMA Disc	21
• Notes on MP3/WMA Recordings	21
• Pause	22
• Moving to another Track	22
• Repeat Track/All/Off	22
• Search	22
• Random	22
• Repeat A-B	22
• 3D Surround	22
• Changing the Audio Channel	22

## Operation with JPEG Disc

Viewing a JPEG disc	23
• Moving to another File	23
• Still Picture	23
• To flip the picture	23
• To rotate picture	23
• Notes on JPEG Recordings	23

## Programmed Playback

Programmed Playback with Audio CD and MP3/WMA disc	24
Programmed Playback with Video CD	24
• Repeat Programmed Tracks	24
• Erasing a Track from Program list	24
• Erasing the Complete Program list	24

## Additional Operation - VCR part

On Screen Display	25
Tape Counter Memory Stop	25
Lock (Child Lock)	25
Video Doctor (Self-Diagnosis)	25
Hi-Fi Stereo Sound System	25

## Additional Operation - DVD part

Last Condition Memory	26
Screen Saver	26

## Special Recording

Copying from DVD to VCR	27
Recording from another video player	27

## Reference

Controlling Your TV with the Supplied Remote Control	28
Troubleshooting	29
Language Code List	30
Country Code list	31
Specification	32

## About the symbols for instructions



 Indicates hazards likely to cause harm to the unit itself or other material damage.

 Indicates special operating features of this unit.

 Indicates tips and hints for making the task easier.

## Before Use

### Playable Discs

	DVD (8 cm / 12 cm disc)
	Video CD (VCD) (8 cm / 12 cm disc)
	Audio CD (8 cm / 12 cm disc)

In addition, this unit can play a DVD±R, DVD±RW, Kodak PICTURE CD and CD-R or CD-RW that contains audio titles, MP3, WMA or JPEG files and SVCD also.

### Notes

- Depending on the conditions of the recording equipment or the CD-R/RW (or DVD±R/±RW) disc itself, some CD-R/RW (or DVD±R/±RW) discs cannot be played on the unit.
- Do not attach any seal or label to either side (the labeled side or the recorded side) of a disc.
- Do not use irregular shaped CDs (e.g., heart-shaped or octagonal). It may result in malfunctions.

### Notes on DVDs and Video CDs

Some playback operations of DVDs and Video CDs may be intentionally fixed by software manufacturers. As this unit plays DVDs and Video CDs according to disc content designed by the software manufacturer, some playback features of the unit may not be available, or other functions may be added. Refer also to the instructions applied with the DVDs and Video CDs. Some DVDs made for business purposes may not be played on the unit.

### Regional code of the DVD player and DVDs

This DVD player is designed and manufactured for playback of region “5” encoded DVD software. The region code on the labels of some DVD discs indicates which type of player can play those discs. This unit can play only DVD discs labeled “5” or “ALL”. If you try to play any other discs, the message “Check Regional Code” will appear on the TV screen. Some DVD discs may not have a region code label even though their playback is prohibited by area limits.



### Disc-related terms

#### Title (DVD only)

The main film content or accompanying feature content or additional feature content, or music album. Each title is assigned a title reference number enabling you to locate it easily.

#### Chapter (DVD only)

Sections of a picture or a musical piece that are smaller than titles.

A title is composed of one or several chapters. Each chapter is assigned a chapter number, enable you to locate the chapter you want. Depending on the disc, no chapters may be recorded.

#### Track (Video CD and audio CD only)

Sections of a picture or a musical piece on a video CD or an audio CD. Each track is assigned a track number, enabling you to locate the track you want.

#### Scene

On a video CD with PBC (Playback control) functions, moving pictures and still pictures are divided into sections called “Scenes”. Each scene is displayed in the menu screen and assigned a scene number, enabling you to locate the scene you want.

A scene is composed of one or several tracks.

### Types of video CDs

There are two types of video CDs:

#### Video CDs equipped with PBC (Version 2.0)

PBC (Playback control) functions allow you to interact with the system via menus, search functions, or other typical computer-like operations. Moreover, still pictures of high resolution can be played if they are included in the disc.

#### Video CDs not equipped with PBC (Version 1.1)

Operated in the same way as audio CDs, these discs allow playback of video pictures as well as sound, but they are not equipped with PBC.

## Before Use (Cont'd)

### Precautions

#### Handling the unit

##### When shipping the unit

The original shipping carton and packing materials come in handy. For maximum protection, re-pack the unit as it was originally packed at the factory.

##### When setting the unit

The picture and sound of a nearby TV or radio may be distorted during playback. In this case, position the unit away from the TV or radio, or turn off the unit after removing the disc.

##### To keep the surface clean

Do not use volatile liquids, such as insecticide spray, near the unit. Do not leave rubber or plastic products in contact with the unit for a long period of time. They will leave marks on the surface.

#### Cleaning the unit

##### To clean the cabinet

Use a soft, dry cloth. If the surfaces are extremely dirty, use a soft cloth lightly moistened with a mild detergent solution. Do not use strong solvents, such as alcohol, benzene, or thinner, as these might damage the surface of the unit.

##### To obtain a clear picture

The DVD player is a high-tech, precision device. If the optical pick-up lens and disc drive parts are dirty or worn down, the picture quality will be poor. Regular inspection and maintenance are recommended after every 1,000 hours of use. (This depends on the operating environment.)  
For details, please contact your nearest dealer.

### Notes on Discs

#### Handling discs

Do not touch the playback side of the disc.  
Hold the disc by the edges so that fingerprints will not get on the surface.  
Do not stick paper or tape on the disc.

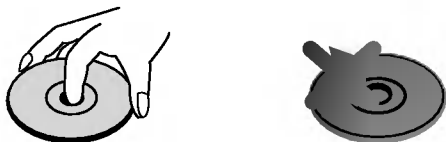

#### Storing discs

After playing, store the disc in its case. Do not expose the disc to direct sunlight or sources of heat, or leave it in a parked car exposed to direct sunlight, as there may be a considerable temperature increase inside the car.

#### Cleaning discs

Fingerprints and dust on the disc can cause poor picture quality and sound distortion. Before playing, clean the disc with a clean cloth. Wipe the disc from the center out.

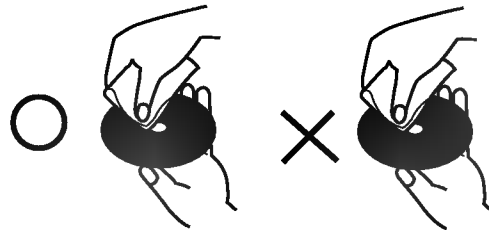

Do not use strong solvents such as alcohol, benzene, thinner, commercially available cleaners, or anti-static spray intended for older vinyl records.







### About Symbols

#### About the Ⓞ symbol display

“Ⓞ” may appear on the TV screen during operation. This icon means the function explained in this owner's manual is not available on that specific DVD video disc.

#### About the disc symbols for instructions

A section whose title has one of the following symbol is applicable only to the disc represented by the symbol.

-  DVD
-  Video CDs with the PBC (playback control) function.
-  Video CDs without the PBC (playback control) function.
-  Audio CDs.
-  MP3 disc.
-  WMA disc.
-  JPEG disc.

# Front Panel and Display Window

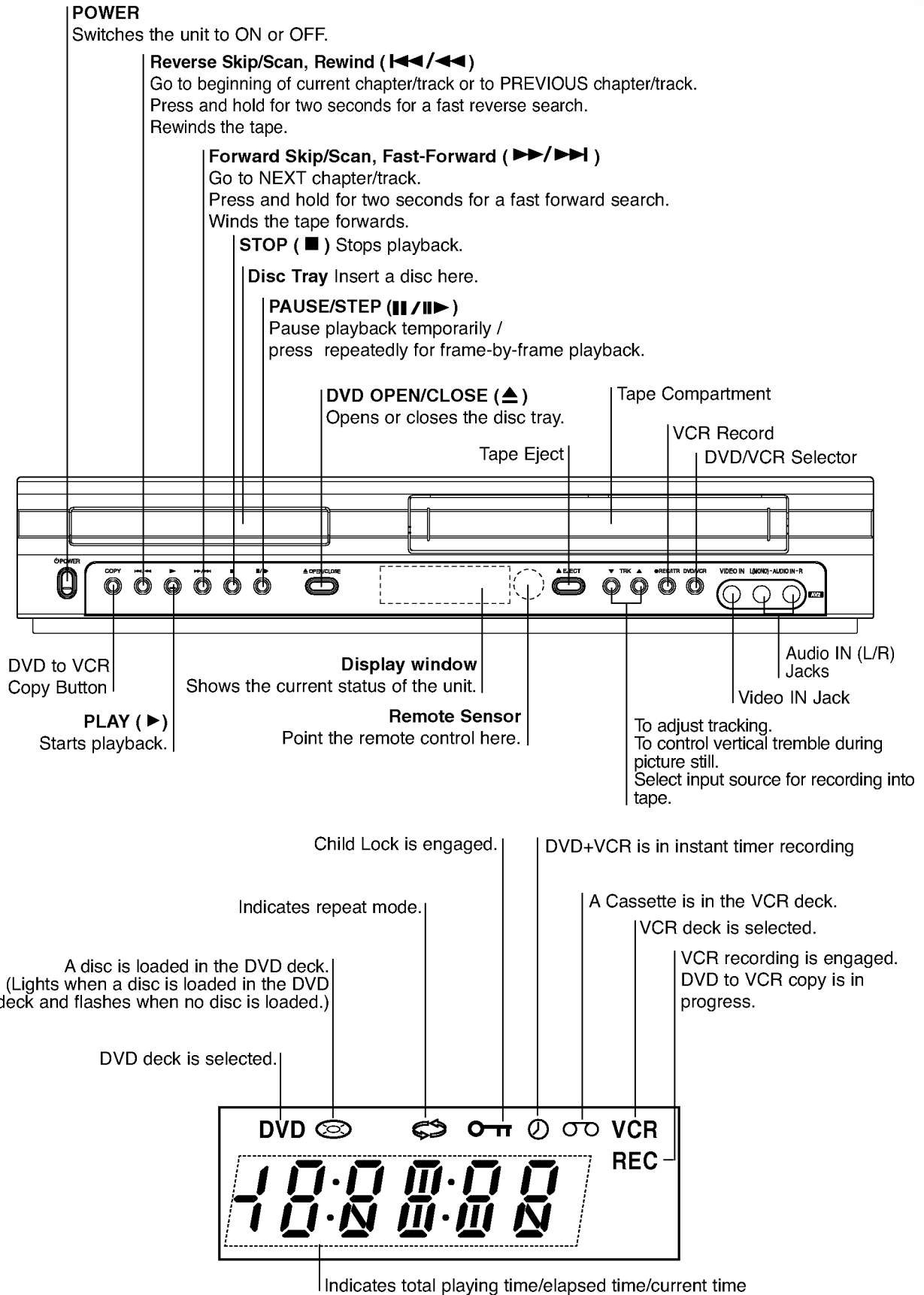

## Remote Control

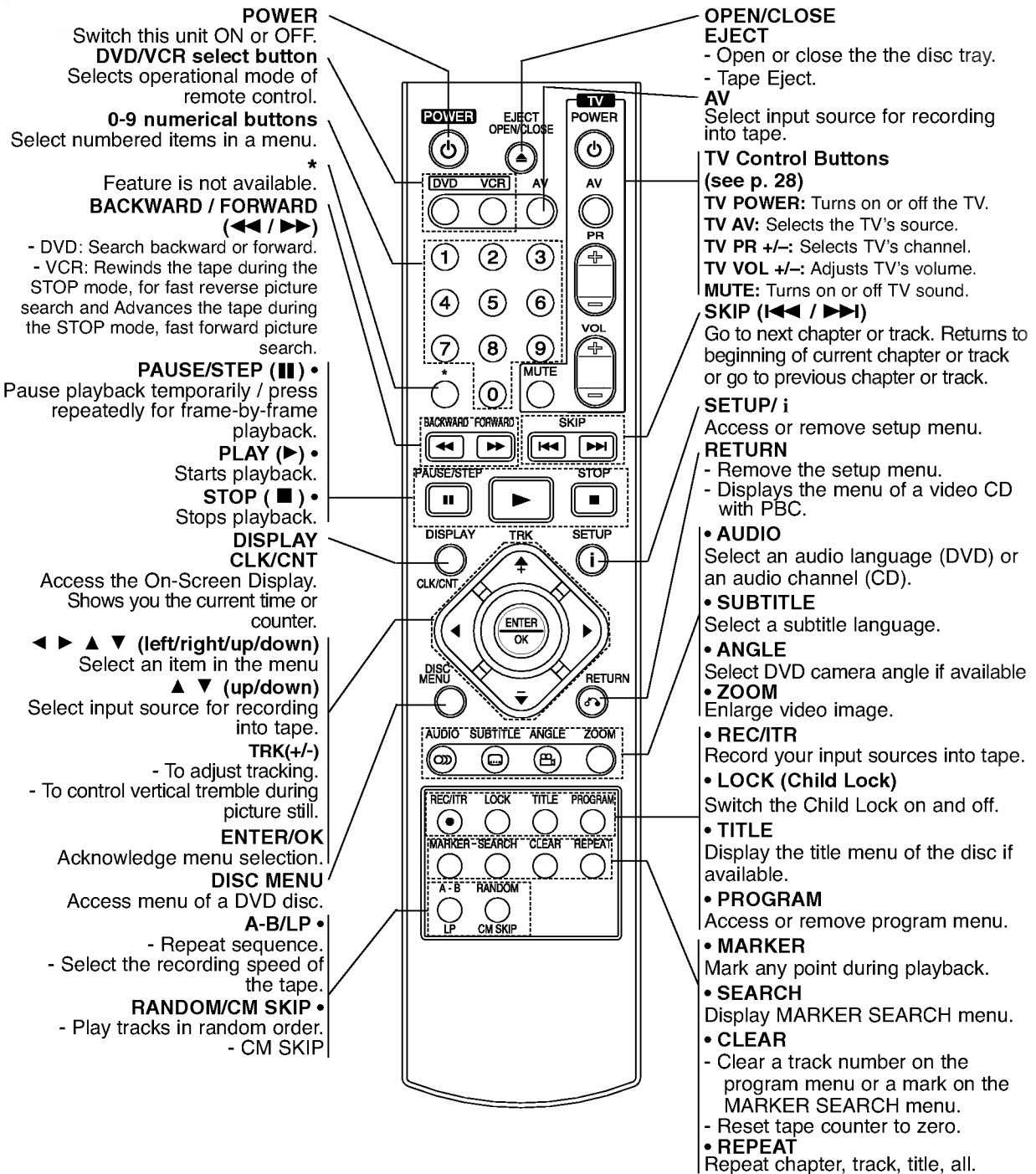

### Remote Control Operation Range

Point the remote control at the remote sensor and press the buttons.

- **Distance:** About 23 ft (7 m) from the front of the remote sensor
- **Angle:** About 30° in each direction of the front of the remote sensor

### Remote control battery installation

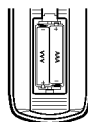

Detach the battery cover on the rear of the remote control, and insert two R03 (size AAA) batteries with ⊕ and ⊖ aligned correctly.

### Caution

Do not mix old and new batteries. Never mix different types of batteries (standard, alkaline, etc.).

## Rear Panel

**AC Power Cord**  
Connect to a power source.

**AUDIO IN (Left/Right) (VCR IN AV1)**

Receive the audio signals from an external source to VCR.

**AUDIO OUT (Left/Right) (Both DVD and VCR out)**

Connect to an amplifier, receiver or stereo system.

**AUDIO OUT (Left/Right) (DVD EXCLUSIVE OUT)**

Connect to an amplifier, receiver or stereo system.

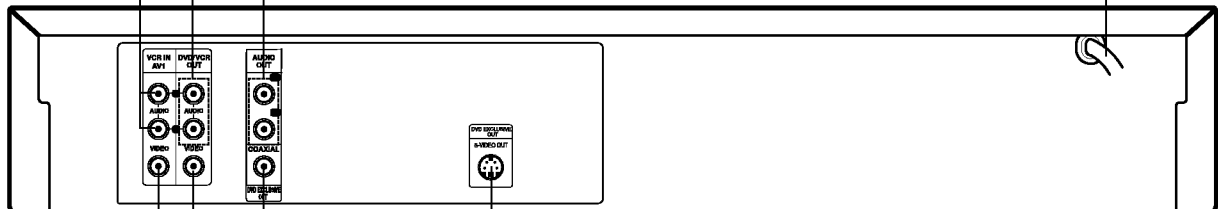

**S-VIDEO OUT (DVD EXCLUSIVE OUT)**

Connect to a TV with S-Video inputs.

**COAXIAL (Digital audio out jack) (DVD EXCLUSIVE OUT)**

Connect to digital (coaxial) audio equipment.

**VIDEO OUT (Both DVD and VCR out)**

Connect to a TV with video inputs.

**VIDEO IN (VCR IN AV1)**

Receive the video signals from an external source to VCR.



Do not touch the inner pins of the jacks on the rear panel. Electrostatic discharge may cause permanent damage to the unit.



## Connections

### Tips

- Depending on your TV and other equipment you wish to connect, there are various ways you could connect the unit.
- Please refer to the manuals of your TV, Stereo System or other devices as necessary to make the best connections.
- For better sound reproduction, connect this unit's AUDIO OUT jacks to the audio in jacks of your amplifier, receiver, stereo or audio/video equipment. See "Connecting to optional equipment" on page 10.

### Caution

- Make sure this unit is connected directly to the TV. Set the TV to the correct video input channel.
- Do not connect this unit's AUDIO OUT jack to the phono in jack (record deck) of your audio system.

## Connecting to a TV

- Make one of the following connections, depending on the capabilities of your existing equipment.
- When using the S-VIDEO OUT jack, set the TV's input to S-VIDEO.

### Basic connection (AV)

- 1** Connect the VIDEO jack on this unit's DVD/VCR OUT to the video in jack on the TV using the video cable.
- 2** Connect the Left and Right AUDIO jacks of this unit's DVD/VCR OUT to the audio left/right in jacks on the TV using the audio cables.

### DVD exclusive out connection

#### S-Video connection

- 1** Connect the S-VIDEO OUT jack on this unit to the S-Video in jack on the TV using the optional S-Video cable.
- 2** Connect the Left and Right AUDIO OUT jacks of this unit to the audio left/right in jacks on the TV using the audio cables.

Rear of this unit (DVD exclusive out connection)

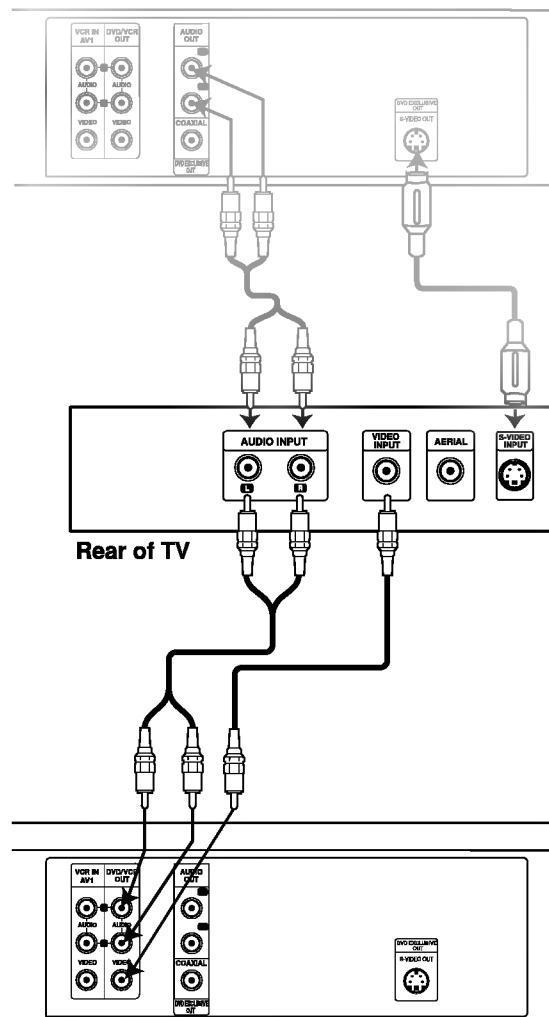

Rear of this unit (Basic connection)

## Connections (Cont'd)

### Connecting to Optional Equipment

#### Connecting to an amplifier equipped with two channel analog stereo or Dolby Pro Logic II / Pro Logic

Connect the Left and Right AUDIO OUT jacks on this unit to the audio left and right in jacks on your amplifier, receiver or stereo system, using the audio cables.

#### Connecting to an amplifier equipped with two channel digital stereo (PCM) or to an Audio/Video receiver equipped with a multi-channel decoder (Dolby Digital™, MPEG 2 or DTS)

**1** Connect this unit's DIGITAL AUDIO OUT jack (COAXIAL) to the corresponding in jack on your amplifier. Use an optional digital (coaxial) audio cable.

**2** You will need to activate this unit's digital output. (See "Digital Audio Output" on page 14).

#### Digital Multi-channel sound

A digital multi-channel connection provides the best sound quality. For this you need a multi-channel Audio/Video receiver that supports one or more of the audio formats supported by your unit (MPEG 2, Dolby Digital and DTS). Check the receiver manual and the logos on the front of the receiver.

#### Warning:

Due to the DTS Licensing agreement, the digital output will be in DTS digital out when DTS audio stream is selected.

#### Notes

- If the audio format of the digital output does not match the capabilities of your receiver, the receiver will produce a strong, distorted sound or no sound at all.
- To see the audio format of the current DVD in the On-Screen Display, press **AUDIO**.

#### Rear of this unit

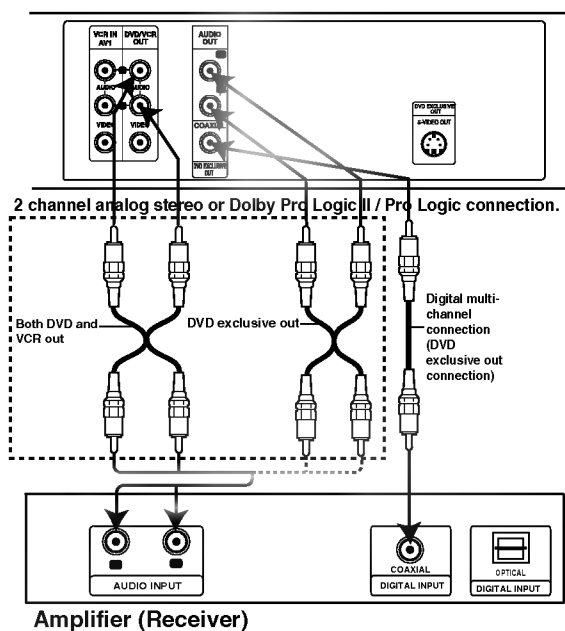

## Before Operation - VCR part

### Setting the clock Manually

The clock in your VCR controls time and date settings for your VCR.

- 1 Press **i**.  
Press **◀** or **▶** to select **TIME DATE**.  
Press **OK**.

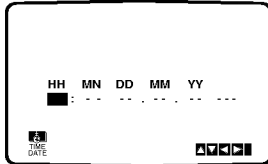

- 2 Use the **numbered buttons** on the remote control to alter the **HOURS, MINUTES, DAY, MONTH and YEAR**.  
Please note your VCR uses a 24 hour clock. e.g. 1pm will be displayed as 13:00.  
The day of the week will appear automatically when you enter the year.

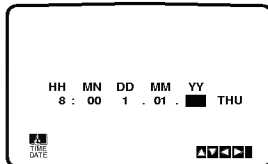

- 3 If you make a mistake press **◀** or **▶** and enter the correct details.

- 4 Press **i**.

### To set the colour system

- 1 Press **i**.
- 2 The main menu will appear on the TV screen.
- 3 Press **◀** or **▶** to select the **SYSTEM** and press **OK**.
- 4 Press **▲** or **▼** to select according to the **COLOUR** system used.



- 5 Press **i** to remove the menus from the TV screen.

### How to using the main menu

This VCR can easily be programmed by using the menus displayed on screen.

The menus are controlled from the Remote Control Handset.

- 1 Switch on your TV set and video player by pressing the **POWER** button.
- 2 Press **i** button.  
The main menu will appear on the TV screen.

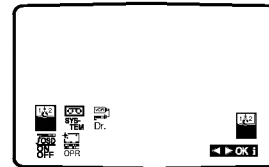

- **TIME DATE** - Date & clock setting (see p 11).
- **SYSTEM** - Select the colour system used for playback and recording (see p 11).
- **Dr.** - To check a problem with your VCR (see p 25).
- **F.OSD ON/OFF** - To switch the display of operating mode of your VCR to on or off.
- **OPR** - To improve the playback picture (see p 16).  
You can set OPR only when a video tape is playing in the video player.

#### Tip

You can change the menu language on the DVD setup menu. (See the Menu Language on page 13.)

- 3 Press **◀** and **▶** to select the option to change, then Press **OK** to change the setting and press **▲** and **▼** to select the sub menu.

- 4 Press **"i"** to remove the menu screen.

## Before Operation - DVD part

### General Explanation

This manual gives the basic instructions for operating this unit. Some DVDs require specific operation or allow only limited operation during playback. When this occurs, the symbol  appears on the TV screen, indicating that the operation is not permitted by this unit or is not available on the disc.









### On-Screen Display

The general playback status can be displayed on the TV screen. Some items can be changed on the menu.

### On-screen display operation





- 1** Press DISPLAY during playback.
- 2** Press ▲ or ▼ to select an item.  
The selected item will be highlighted.
- 3** Press ◀ or ▶ to change the setting of an item.  
The number buttons can be also be used for setting numbers (e.g., title number). For some functions, press ENTER to execute the setting.

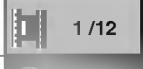

### Temporary Feedback Field Icons

-  Repeat Title
-  Repeat Chapter
-  Repeat Track (non-PBC Video CDs only)
-  Repeat All Tracks (non-PBC Video CDs only)
-  Repeat A-B
-  Repeat Off
-  Resume play from this point
-  Action prohibited or not available

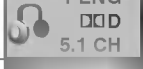
### Notes

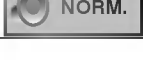
- Some discs may not provide all of the below On-Screen Display.
- If no button is pressed for 10 seconds, the On-Screen Display disappears.

Items		Function (Press ▲/▼ to select desired item)	Selection Method
Title Number	 1 / 3	Shows the current title number and total number of titles, and skips to the desired title number.	◀ / ▶, or Numbers, ENTER
Chapter Number	 1 / 12	Shows the current chapter number and total number of chapters, and skips to the desired chapter number.	◀ / ▶, or Numbers, ENTER
Time search		Shows the elapsed playing time, and searches the point by the elapsed time directly.	Numbers, ENTER
Audio language and Digital Audio Output mode	 1 ENG D D D 5.1 CH	Shows the current audio soundtrack language, encoding method, and channel number, and changes the setting.	◀ / ▶, or AUDIO
Subtitle language		Shows the current subtitles language, and changes the setting.	◀ / ▶, or SUBTITLE
Angle		Shows the current angle number and total number of angles, and changes the angle number.	◀ / ▶, or ANGLE
Sound	 NORM.	Shows the current sound mode, and changes the setting.	◀ / ▶

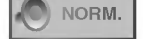
Items		Function (Press ▲/▼ to select desired item)	Selection Method
Track Number	 1 / 4	Shows the current track number, total number of tracks and PBC On mode, and skip to the desired track number.	◀ / ▶, or Numeric, ENTER
Time		Shows the elapsed playing time (Display only)	-
Audio Channel	 STER.	Shows the audio channel, and changes the audio channel.	◀ / ▶, or AUDIO
Sound	 NORM.	Shows the current sound mode, and changes the setting.	◀ / ▶

## Before Operation (Cont'd) - DVD part

### Initial Settings

You can set your own Personal Preferences on this unit.

### Initial Settings General Operation

- 1** Press **SETUP**.  
The setup menu appears.

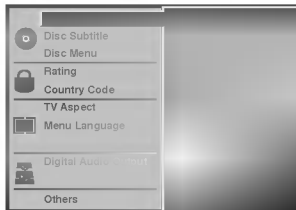

- 2** Press **▲/▼** to select the desired item.  
The screen will show the current setting for the selected item, as well as alternate setting(s).
- 3** While the desired item is selected, press **▶**, then **▲/▼** to select the desired setting.
- 4** Press **ENTER** to confirm your selection.  
Some items require additional steps.
- 5** Press **SETUP**, **RETURN** or **PLAY** to exit the setup menu.

### Language

#### Disc Language

Select a language for the disc's Menu, Audio and Subtitle.

**Original** : The original language set for the disc is selected.  
**Other** : To select another language, press number buttons to enter the corresponding 4-digit number according to the language code list on page 30. If you enter the wrong language code, press **CLEAR**.



### Menu Language

Select a language for the setup menu. This is the menu you see when you press **SETUP**.



### Picture

#### TV Aspect

**4:3 Letterbox**: Select when a standard 4:3 TV is connected. Displays theatrical images with masking bars above and below the picture.

**4:3 Panscan**: Select when a conventional TV set is connected. The video material formatted in the Pan & Scan style is played back in that style (Both sides of the picture are cut off).

**16:9 Wide**: Select when a 16:9 wide TV is connected.



## Before Operation (Cont'd) - DVD part

### Sound

#### Digital Audio Output

Each DVD disc has a variety of audio output options. Set this unit's Digital Audio Output according to the type of audio system you use.

**DOLBY DIGITAL/PCM:** Select "DOLBY DIGITAL/PCM" if you connected this unit's DIGITAL OUT jack to a Dolby Digital decoder (or an amplifier or other equipment with a Dolby Digital decoder).

**Stream/PCM:** Select "Stream/PCM" if you connected this unit's DIGITAL OUT jack to an amplifier or other equipment with a DTS decoder, Dolby Digital decoder or MPEG decoder.

**PCM:** Select when connected to a 2 channel digital stereo amplifier. This unit outputs sounds in the PCM 2ch format when you play a DVD video disc recorded on the Dolby Digital, MPEG1 or MPEG2 recording system.

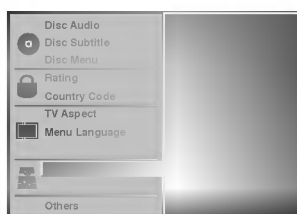

#### Sample Frequency

To change the Sample Frequency setting, first select the desired Digital Audio Output as indicated as above. If your receiver or amplifier is NOT capable of handling 96KHz signals, select 48KHz. When this choice is made, this unit will automatically convert any 96KHz signals to 48KHz so your system can decode them. If your receiver or amplifier is capable of handling 96KHz signals, select 96KHz. When this choice is made, this unit will pass each type of signal through without any further processing.

### Others

The DRC, Vocal, PBC and Auto Play settings can be changed.

- Press ▲/▼ to select the desired item and press ENTER. The setting of the selected item is changed between On and Off.



#### Dynamic Range Control (DRC)

With the DVD format, you can hear a program's soundtrack in the most accurate and realistic presentation possible, thanks to digital audio technology. However, you may wish to compress the dynamic range of the audio output (the difference between the loudest sounds and the quietest ones). Then, you may listen to a movie at a lower volume without losing clarity of sound. Set DRC to On for this effect.

#### Vocal

Set Vocal to On only when a multi-channel karaoke DVD is playing. The karaoke channels on the disc will mix into a normal stereo sound.

#### PBC

Set Playback Control (PBC) to On or Off.

**On:** Video CDs with PBC are played according to the PBC.

**Off:** Video CDs with PBC are played the same way as Audio CDs.

#### Auto Play

You can set up the DVD Player so a DVD disc automatically starts playing whenever the DVD is inserted.

If Auto Play mode is set to On, this DVD player will search a title that playback time is long most and then play back the title automatically.

**On:** Auto Play function is activated.

**Off:** Auto Play function is not activated.



#### Note

The Auto Play function may not work for some DVDs.

## Before Operation (Cont'd) - DVD part

### Parental Control

#### Rating

Movies on DVDs may contain scenes not suitable for children. Therefore, discs may contain Parental Control information that applies to the complete disc or to certain scenes on the disc. These scenes are rated from 1 to 8, and alternatively, more suitable scenes are available for selection on some discs. Ratings are country-dependent. The Parental Control feature allows you to prevent discs from being played by your children or to have certain discs played with alternative scenes.

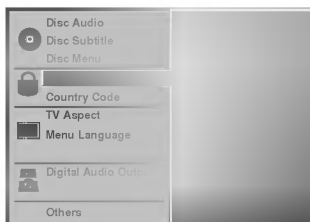

**1** Select "Rating" on the Setup menu using the ▲ and ▼ buttons.

**2** While "Rating" is selected, press ►.

**3** When you have not entered a password yet. Enter a 4-digit password using the numbered buttons to create a personal 4-digit security password, then press ENTER. Enter the 4-digit password again and press ENTER to verify.

**When you have already entered a password;** Enter a 4-digit password using the numbered buttons to confirm the personal 4-digit security password, then press ENTER.

If you make a mistake before pressing ENTER, press CLEAR and enter 4-digit security password again.

**4** Select a rating from 1 to 8 using the ▲▼ buttons. One (1) has the least playback restrictions. Eight (8) has the most playback restrictions.

**Unlock:** If you select Unlock, Parental Control is not active. The disc will play in full.

**Ratings 1 to 8:** Some discs contain scenes not suitable for children. If you set a rating for the player, all disc scenes with the same rating or lower will be played. Higher rated scenes will not be played unless an alternative scene is available on the disc. The alternative must have the same rating or a lower one. If no suitable alternative is found, playback will stop. You must enter the 4-digit password or change the rating level in order to play the disc.

**5** Press ENTER to confirm your rating selection, then press SETUP to exit the menu.

#### Country Code

Enter the code of a country/area whose standards were used to rate the DVD video disc, referring to the list (See "Country Code List", page 31.).



**1** Select Country Code using the ▲▼ buttons on the setup menu.

**2** While Country Code is selected, press ►.

**3** Follow step 3 of "Rating" on left.

**4** Select the first character using the ▲▼ buttons.

**5** Shift the cursor using ◀▶ buttons and select the second character using ▲▼ buttons.

**6** Press ENTER to confirm your country code selection, then press SETUP to exit the menu.

#### Note

Confirmation of the 4-digit password is necessary when the code is changed (see "Changing the 4-digit code" below).

#### Changing the 4-digit code

- 1 Follow Steps 1-2 as shown above to the left (Rating).
- 2 Enter the old code, then press ENTER.
- 3 Select **Change** using the ▲▼ buttons then press ENTER.
- 4 Enter the new 4-digit code, then press ENTER.
- 5 Enter exactly the same code a second time and verify by pressing ENTER.
- 6 Press SETUP to exit the menu.

#### If you forget your 4-digit code

If you forget your password, to clear the current password, follow the procedure below.

- 1 Press SETUP to display the setup menu.
- 2 Use the Number buttons to enter the 6-digit number "210499".  
The 4-digit password is cleared.
- 3 Enter a new code as shown above to the left (Rating).

## Operation with tape

### Playing a tape

You will only be able to load and eject video cassettes when your VCR is plugged into the mains. Your VCR may also playback recordings from NTSC tapes (on PAL TV).

#### Getting a better picture

When a cassette is inserted and playback started, the automatic tracking function works to get the best possible picture automatically. If the quality of the recording is poor, repeatedly press **TRK +** or **-** on the remote control to manually adjust the tracking until any distortions have been removed. Press numbered **0** on the remote control to switch automatic tracking back on again.

- 1** Make sure that you have correctly connected your VCR as described earlier in this book.  
Turn on your TV.  
Press **POWER** to turn on your VCR.  
Insert the video cassette into your VCR.  
The video cassette should have the window side facing up and the arrow facing away from you.

- 2** Press **PLAY** to start playing your tape.  
If you load a video cassette which has had its record protection tab removed, playback of the cassette will start automatically.

#### AUTO TRACKING

Your VCR will automatically adjust the tracking to give the best picture quality.

- 3** Press **PAUSE/STEP** to still a picture.  
Press **PAUSE/STEP** repeatedly to advance the tape frame by frame.  
If you press **FORWARD**, the picture will be slowed down at about 1/19 times the normal playback. Tapes can be paused for up to 5 minutes. After 5 minutes your VCR will stop the tape to prevent damaging the tape or your VCR.  
Still picture quality can be improved slightly by pressing **TRK +** or **-**.

- 4** Press **PLAY** to continue playing your tape.  
**Picture search:**  
During playing back press either **FORWARD** or **BACKWARD** and this will enable you to rapidly wind the tape (7 times normal playback) and see where you are on the tape.

#### Logic search:

During fast forwarding or rewinding press and hold **FORWARD** or **BACKWARD** the picture will be played back at 7 times normal playback speed.

### 5 Slow motion playback, Shuttle :

During playing back or still picture press **◀** or **▶**. You can reach the following playback speeds. (-7xplay, -3xplay, -play, still, 1/19 slow, play, 2xplay, 7xplay)  
To switch off the slow motion and shuttle, press the desired function.  
During slow motion and shuttle, the noise bars may appear on the picture according to the status of tape.  
If distortions can be seen in the picture, reduce them with **TRK +** or **-**.

- 6** Press **STOP** to end playback.  
Press **EJECT**.  
If the end of the tape is reached, your VCR will stop playback automatically, rewind, stop, eject the tape.

#### CM (Commercial Message) Skip:

This feature enables you during playback of a tape to skip a commercial break in a few seconds, then resume normal playback.

While tape is playing press **CM SKIP** on the remote control to skip commercial (or another programme material).

Repeatedly press **CM SKIP** to skip:

- 1 Press 30 seconds
- 2 Press 60 seconds
- 3 Press 90 seconds
- 4 Press 120 seconds
- 5 Press 150 seconds
- 6 Press 180 seconds

#### OPR (Optimum Picture Response)

This feature automatically improves playback picture quality by adjusting your VCR to the condition of the tape.

- 1** Press **i**.
- 2** Press **◀** or **▶** to select OPR.
- 3** Press **OK**.



- 4** Press **▲** or **▼** repeatedly to select: **OFF**, **SOFT** or **SHARP**.

**Please note you may only set OPR when playing a tape.**

- 5** Press **i** to remove the menus.



## Operation with tape

### Recording

Your VCR allows you to make recordings connecting to a TV equipped with audio out and video out sockets.

Your VCR start recording immediately for a set period of time (ITR : Instant Timer Recording) or until the video cassette runs out.

Your VCR incorporates Long Play (LP) which enables you to record up to twice the amount of time on a video cassette. For example an E-180 will record up to 180 minutes using Standard Play (SP); using LP you will be able to record up to 360 minutes. Please note there will be a slight loss in picture and sound quality when using LP.

**1** Connect the **AUDIO(L/R)/VIDEO (VCR IN AV1)** on the rear panel of this unit or **AUDIO IN (L(MONO)/R)/VIDEO IN** on the front of this unit to the audio out and video out sockets on the TV using the audio and video cables.

**2** Insert a video cassette with protection tab into your VCR.  
The video cassette should have the window side facing up and the arrow facing away from you.  
Your unit will switch on automatically. You can also switch it on with the **POWER** button.

**3** Select the channel you wish to record with the TV's channel selector.

**4** Press **AV** until the socket you wish to record from is displayed.

**AV 1** for recording from **AUDIO (L/R)/VIDEO (VCR IN AV1)** terminals on the rear of your unit.

**AV 2** for recording from **AUDIO IN (L(MONO)/R)/VIDEO IN** terminals on the front of your unit.

**5** Press **LP** if you wish to record in Long Play or Standard Play.

SP will produce improved picture and sound quality, however LP will provide twice as much recording time as SP.

SP or LP will be displayed in your VCR display to let you know which you have selected.

**6** Press **REC/ITR** to start recording.  
**RECORD** will appear on the TV screen.  
Press **REC/ITR** several times. Each successive press will increase the record time by 30 minutes until you reach a maximum of 9 hours.

**7** Press **PAUSE/STEP** to avoid recording unwanted scenes.

Press **PAUSE/STEP** to continue recording.

If you press **PAUSE/STEP** during ITR, this unit will enter the record pause mode and the recording mode will be back to normal recording mode.

Tapes can be paused for up to 5 minutes; **RECP** will be displayed when a tape is paused. After 5 minutes your VCR will stop recording to prevent damaging the tape or your VCR.

**8** Press **STOP** to end recording.

Press **EJECT**.

**EJECT** will appear on the TV screen for a few seconds.

If the end of the tape is reached, your VCR will stop recording automatically, rewind, stop, eject the tape.

### **N** Notes

- If you do not wish to record on a tape (this can happen quite easily by accident!) remove the protection tab on the back edge of the video cassette.
- It is possible to record on a video cassette with the record protection tab removed by covering the hole with self adhesive tape.

## Operation with DVD and Video CD

### Playing a DVD and Video CD

#### Playback Setup

- Turn on the TV and select the video input source connected to the DVD player.
- Audio system: Turn on the audio system and select the input source connected to the DVD player.

**1** Press OPEN/CLOSE to open the disc tray.

**2** Load your chosen disc in the tray, with the label facing up.

When a double-sided DVD is inserted, make sure the side you want to play is facing down.

**3** Press OPEN/CLOSE to close the tray.

READING appears on the TV screen, and playback starts automatically. If playback does not start, press PLAY.

In some cases, the disc menu might appear instead.

#### If a menu screen is displayed

The menu screen may be displayed first after loading a DVD or Video CD which contains a menu.

 Use the ◀ ▶ ▲ ▼ buttons to select the title/chapter you want to view, then press ENTER to start playback. Press TITLE or DISC MENU to return to the menu screen.

 Use the number buttons to select the track you want to view.

Press RETURN to return to the menu screen.

- Menu setting and the exact operating procedures for using the menu may differ depending on the disc. Follow the instructions on the each menu screen. You also may set PBC to Off under setup. See page 14.

#### Notes

- If Parental Control is set and the disc is not within the Rating settings (not authorized), the 4-digit code must be entered and/or the disc must be authorized (see “Parental Control”, on page 15).
- DVDs may have a region code.
- Your player will not play discs that have a region code different from your player. The region code for this player is 5 (five).
- If you load a video cassette which has had its record protection tab removed during playing the DVD, the mode will be switched to VCR automatically.

### General Features

#### Note

Unless stated otherwise, all operations described use the remote control. Some features may also be available on the Setup menu.

#### Moving to another TITLE



When a disc has more than one title, you can move to another title as follows:

- Press DISPLAY, then press the appropriate numbered button (0-9) to select a title number.

#### Moving to another CHAPTER/TRACK



When a title on a disc has more than one chapter or a disc has more than one track, you can move to another chapter/track as follows:

- Press ◀◀ or ▶▶ briefly during playback to select the next chapter/track or to return to the beginning of the current chapter/track.
- Press ◀◀ twice briefly to step back to the previous chapter/track.
- To go directly to any chapter during DVD playback, press DISPLAY. Then, press ▲▼ to select the chapter/track icon. Then, enter the chapter/track number using the numbered buttons (0-9).

#### Note

For two-digit numbers, press the numbered buttons (0-9) in rapid succession.

#### Slow Motion

- 1 Press ◀◀ or ▶▶ during pause. The player will enter SLOW mode.
- 2 Use the ◀◀ or ▶▶ to select the required speed: ◀◀ 1/16, ◀◀ 1/8, ◀◀ 1/4 or ◀◀ 1/2 (backward), or ▶▶ 1/16, ▶▶ 1/8, ▶▶ 1/4 or ▶▶ 1/2 (forward).
- 3 To exit slow motion mode, press PLAY.

#### Note

Slow motion playback in reverse is not applicable for Video CD.

## Operation with DVD and Video CD

### General Features (continued)

#### Still Picture and Frame-by-frame playback

- 1 Press PAUSE/STEP during playback.  
The player will now go into pause mode.
- 2 You can advance the picture frame-by-frame by pressing PAUSE/STEP repeatedly on the remote control.

#### Search

- 1 Press ◀◀ or ▶▶ during playback.  
The player will now go into SEARCH mode.
- 2 Press ◀◀ or ▶▶ repeatedly to select the required speed: ◀◀X2, ◀◀X4, ◀◀X16, ◀◀X100 (backward) or ▶▶X2, ▶▶X4, ▶▶X16, ▶▶X100 (forward).  
With a Video CD, the Search speed changes: ◀◀X2, ◀◀X4, ◀◀X8 (backward) or ▶▶X2, ▶▶X4, ▶▶X8 (forward).
- 3 To exit SEARCH mode, press PLAY.

#### Random

- 1 Press RANDOM during playback or in stop mode.  
The unit automatically begins Random Playback and "RANDOM" appears on the TV screen.
- 2 To return to normal playback, press RANDOM again until "NORMAL" appears on the TV screen.



#### Tips

By pressing ▶▶ during Random playback, the unit selects another title (track) and resumes Random playback.



#### Note

- This function only works with DVD Karaoke discs and video CD without PBC.
- On a Video CD with PBC, you must set PBC to Off on the setup menu to use the Random function. See page 14.

#### Repeat



#### DVD Video Discs - Repeat Chapter/Title/Off

- 1 To repeat the currently playing chapter, press REPEAT.  
The Repeat Chapter icon appears on the TV screen.
- 2 To repeat the title currently playing, press REPEAT a second time.  
The Repeat Title icon appears on the TV screen.
- 3 To exit Repeat mode, press REPEAT a third time.  
The Repeat Off icon appears on the TV screen.

#### Video CDs - Repeat Track/All/Off

- 1 To repeat the track currently playing, press REPEAT.  
The Repeat Track icon appears on the TV screen.
- 2 To repeat the disc currently playing, press REPEAT a second time.  
The Repeat All icon appears on the TV screen.
- 3 To exit Repeat mode, press REPEAT a third time.  
The Repeat Off icon appears on the TV screen.



#### Note

On a Video CD with PBC, you must set PBC to Off on the setup menu to use the Repeat function. See page 14.

#### Repeat A-B



To repeat a sequence in a title:

- 1 Press A-B at your chosen starting point.  
A\* appears briefly on the TV screen.
- 2 Press A-B again at your chosen end point.  
A B appears briefly on the TV screen, and the repeat sequence begins.
- 3 To cancel the sequence, press A-B.

#### Time Search



The Time Search function allows you to start playing at any chosen time on the disc.

- 1 Press DISPLAY during playback. The on-screen display appears on the screen.  
The Time Search box shows the elapsed playing time of the current disc.
- 2 Within 10 seconds, press ▲/▼ to select the Time Search icon in the on-screen display.  
The ":-:--:" appears in the Time Search box.
- 3 Within 10 seconds, use the number buttons to enter the required start time. Enter hours, minutes, and seconds from left to right in the box.  
If you enter the wrong numbers, press CLEAR to remove the numbers you entered. Then enter the correct numbers.
- 4 Within 10 seconds, press ENTER to confirm the start time.  
Playback starts from the selected time on the disc. If you enter an invalid time, playback will continue from the current point.

#### 3D Surround



This unit can produce a 3D Surround effect, which simulates multi-channel audio playback from two conventional stereo speakers, instead of the five or more speakers normally required to listen to multi-channel audio from a home theater system.

- 1 Press DISPLAY during playback.
- 2 Press ▲/▼ to select "NORM." or "3D SUR".
- 3 Press ◀▶ repeatedly until the desired sound is selected.

## Operation with DVD and Video CD

### General Features (continued)

#### Zoom

The Zoom function allows you to enlarge the video image and to move through the enlarged image.

- 1 Press ZOOM during playback or still playback to activate the Zoom function.

If you press ZOOM repeatedly, the magnification level increases up to six times.

- 2 Use the ◀▶▲▼ buttons to move through the zoomed picture.
- 3 Press CLEAR to resume normal playback or return to the paused image.

#### Note

- The zoom function may not work for some DVDs.
- The zoom function may not work on multi-angle scenes.

#### Marker Search



You can start playback from a memorized point. Up to nine points can be memorized.

To enter a mark, follow these steps.

- 1 During disc playback, press MARKER when playback reaches the spot that you want to memorize.

The Marker icon will appear on the TV screen briefly.

- 2 Repeat step 1 to enter up to nine Marker points on a disc.

#### To Recall a Marked Scene

- 1 During disc playback, press SEARCH.  
The MARKER SEARCH menu will appear on the screen.
- 2 Within 10 seconds, press ◀▶ to select a Marker number that you want to recall.
- 3 Press ENTER.  
Playback will start from the Marked scene.
- 4 To remove the MARKER SEARCH menu, press SEARCH.

#### To clear a Marked Scene

- 1 During disc playback, press SEARCH.  
The MARKER SEARCH menu will appear on the screen.
- 2 Press ◀▶ to select the Marker number that you want to erase.
- 3 Press CLEAR.  
The Marker number will be erased from the list.
- 4 Repeat steps 2 and 3 to erase additional Marker numbers.
- 5 To remove the MARKER SEARCH menu, press SEARCH.

### Special DVD Features

#### Checking the contents of DVD Video discs: Menus

DVDs may contain menus that allow you to access special features. To use the disc menu, press DISC MENU. Then, press the appropriate number button to select an option. Or, use the ◀▶/▲/▼ buttons to highlight your selection, then press ENTER.

#### Title Menu

- 1 Press TITLE.  
If the current title has a menu, the menu will appear on the screen. Otherwise, the disc menu may appear.
- 2 The menu can list camera angles, spoken language and subtitle options, and chapters for the title.
- 3 To remove the title menu, press TITLE again.

#### Disc Menu

- 1 Press DISC MENU.  
The disc menu is displayed.
- 2 To remove the disc menu, press DISC MENU again.

#### Camera Angle



If the disc contains scenes recorded at different camera angles, you can change to a different camera angle during playback.

- Press ANGLE repeatedly during playback to select a desired angle.  
The number of the current angle appears on the display.

#### Changing the Audio Language



Press AUDIO repeatedly during playback to hear a different audio language or audio track.

#### Changing the Audio Channel

Press AUDIO repeatedly during playback to hear a different audio channel (STER., LEFT or RIGHT).

#### Subtitles



Press SUBTITLE repeatedly during playback to see the different subtitle languages.

#### Note

If ⊘ appears, the feature is not available on the disc.

## Operation with Audio CD and MP3/WMA Disc

### Playing an Audio CD and MP3/WMA Disc



The DVD Player can play MP3/WMA formatted recordings on CD-ROM, CD-R or CD-RW discs. Before playing MP3/WMA recordings, read the notes on MP3/WMA Recordings on right.

- 1 Insert a disc and close the tray.**  
**Audio CD;** Audio CD menu appears on the TV screen go to step 4.  
**MP3/WMA disc;** The MP3/WMA-JPEG choice menu appears on the TV screen. Go to step 2



- 2 Press ▲▼ to select the MP3/WMA then press ENTER.**  
The MP3/WMA menu appears on the TV screen. Press RETURN to move to the MP3/WMA-JPEG choice menu.

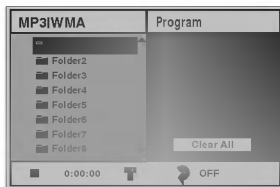

- 3 Press ▲▼ to select a folder, and ENTER.**  
A list of files in the folder appears.

- 4 Press ▲▼ to select a track then press PLAY or ENTER.**  
Playback starts.  
During playback, the current track's elapsed playing time will appear on the display window and menu. Playback will stop at the end of the disc.  
Press TITLE to move to the next page.  
Press DISC MENU to move to the previous page.

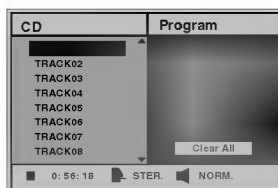

Audio CD menu



MP3/WMA menu



**Tip**  
If you are in a file list and want to return to the Folder list, use the ▲▼ to highlight ■ and press ENTER to return to the previous menu screen.

- 5 To stop playback at any other time, press STOP.**

### Notes on MP3/WMA Recordings

#### About MP3

- An MP3 file is audio data compressed by using the MPEG1 audio layer-3 file-coding scheme. We call files that have the “.mp3” file extension “MP3 files”.
- The player can not read an MP3 file that has a file extension other than “.mp3”.

#### About WMA(Window Media Audio)

- An WMA file is a Microsoft audio compression technology.
- WMA(Windows Media Audio) offers double the audio compression of the MP3 format.

#### MP3/WMA Disc compatibility with this player is limited as follows:

1. Sampling Frequency / only at 44.1kHz (MP3), 22.05-44.1 kHz (WMA)
2. Bit rate / within 32 - 320kbps (MP3), 32-128 kbps (WMA)
3. CD-R physical format should be “ISO 9660”
4. If you record MP3/WMA files using the software which cannot create a FILE SYSTEM, for example “Direct-CD” etc., it is impossible to playback MP3/WMA files. We recommend that you use “Easy-CD Creator”, which creates an ISO9660 file system.
5. A single session disc requires MP3/WMA files in the first track. If there is no MP3/WMA file in the 1st track, it cannot playback MP3/WMA files. If you wish to playback MP3/WMA files, format all the data in the disc or use a new one.
6. File names should be named using 8 letters or less and must incorporate “.mp3” or “.wma” extension e.g. “\*\*\*\*\*.MP3” or “\*\*\*\*\*.WMA”.
7. Do not use special letters such as “/ : \* ? “ < > ” etc.
8. Total number of files on the disc should be less than 650.

This DVD player requires discs/recordings to meet certain technical standards in order to achieve optimal playback quality. Pre-recorded DVDs are automatically set to these standards. There are many different types of recordable disc formats (including CD-R containing MP3 or WMA files). That require certain pre-existing conditions (see above) to insure compatible playback.

**Customers should also note that permission is required in order to download MP3/WMA files and music from the Internet. Our company has no right to grant such permission. Permission should always be sought from the copyright owner.**

## Operation with Audio and MP3/WMA Disc

### Pause

- 1 Press PAUSE/STEP during playback.
- 2 To return to playback, press PLAY or press PAUSE/STEP again.

### Moving to another Track

- Press **I◀** or **▶I** briefly during playback to go to the next track or to return to the beginning of the current track.
- Press **I◀◀** twice briefly to step back to the previous track.
- In case of audio CD, to go directly to any track, enter the track number using the numbered buttons (0-9) during playback.

### Repeat Track/All/Off

- 1 To repeat the track currently playing, press REPEAT. The Repeat icon and "TRACK" appears on the menu screen.
- 2 To repeat all tracks on a disc, press REPEAT a second time. The Repeat icon and "ALL" appears on the menu screen.
- 3 To cancel Repeat mode, press REPEAT a third time. The Repeat icon and "OFF" appears on the menu screen.

### Search

- 1 Press **◀◀** or **▶▶** during playback. The player will now go into SEARCH mode.
- 2 Press **◀◀** or **▶▶** repeatedly to select the required speed: **◀◀X2**, **◀◀X4**, **◀◀X8** (backward) or **▶▶X2**, **▶▶X4**, **▶▶X8** (forward). Search speed and direction are indicated on the menu screen.
- 3 To exit SEARCH mode, press PLAY.

### Random

- 1 Press RANDOM during playback or when playback is stopped. The unit automatically begins Random Playback and "RAND." appears on the menu screen.
- 2 To return to normal playback, press RANDOM repeatedly until "RAND." disappears on the menu screen.

### Repeat A-B

To repeat a sequence.

- 1 During disc playback, press A-B at your chosen starting point. The Repeat icon and "A \* " appears on the menu screen.
- 2 Press A-B again at your chosen end point. The Repeat icon and "A B" appears on the menu screen, and the sequence begins to play repeatedly.
- 3 To exit the sequence and return to normal play, press A-B again. The Repeat icon and "OFF" appears on the menu screen.

### 3D Surround

This unit can produce a 3D Surround effect, which simulates multi-channel audio playback from two conventional stereo speakers, instead of the five or more speakers normally required to listen to multi-channel audio from a home theater system.

- 1 Press DISPLAY or AUDIO during playback.
- 2 Press **◀▶** to select "NORM." or "3D SUR".
- 3 Press **▲▼** repeatedly until the desired sound is selected.

### Changing the Audio Channel

Press AUDIO repeatedly during playback to hear a different audio channel (STER., LEFT, or RIGHT).

## Operation with JPEG Disc

### Viewing a JPEG disc

This DVD Player can play discs with JPEG files and Kodak picture CD. Before playing JPEG recordings, read the notes on JPEG Recordings on right.

- 1 Insert a disc and close the tray.**  
The MP3/WMA-JPEG choice menu appears on the TV screen.



- 2 Press ▲▼ to select the JPEG then press ENTER.**  
The JPEG menu appears on the TV screen.



- 3 Press ▲▼ to select a folder, and ENTER.**  
A list of files in the folder appears.  
Press RETURN to move to the MP3/WMA-JPEG choice menu.

#### Tip

If you are in a file list and want to return to the Folder list, use the ▲▼ buttons on the remote to highlight "■" and press ENTER to return to the previous menu screen.

- 4 If you want to view a particular file, press ▲▼ to highlight a file and press ENTER or PLAY.**  
Viewing the file proceeding starts.  
During viewing a file, press RETURN to move to the previous menu (JPEG menu).  
Press TITLE to move to the next page.  
Press DISC MENU to move to the previous page.



#### Tip

There are three viewing Slide Speed options: Fast, Normal, and Off. Press ◀▶ to highlight the Slide Speed then press ▲▼ to select the option you want to use, and press ENTER.

- 5 To stop viewing at any other time, press STOP.**  
The JPEG menu appears.

### Moving to another File

Press ◀◀ or ▶▶ once during viewing a picture to advance to the next file or to the previous file.

### Still Picture

- 1 Press PAUSE/STEP during slide show.  
The player will now go into PAUSE mode.
- 2 To return to the slide show, press PLAY or press PAUSE/STEP again.

### To flip the picture

Press ▲▼ during showing a picture to flip the picture horizontally or a vertically.

### To rotate picture

Press ◀▶ during showing a picture to rotate the picture clockwise or counter clockwise.

### Notes on JPEG Recordings

- Depending upon the size and number of the JPEG files, it could take a long time for the DVD player to read the disc's contents. If you don't see an on-screen display after several minutes, some of the files are too big — reduce the resolution of the JPEG files to less than 2 mega pixels and burn another disc.
- Total number of files and folders on the disc should be less than 650.
- Some disc may be incompatible due to different recording format or condition of disc.
- When you are using software such as "Easy CD Creator" to burn the jpeg files into the CD-R, ensure that all the selected files have the ".jpg" extensions when copying into the CD layout.
- If the files have ".jpe" or ".jpeg" extensions, please rename them as ".jpg" files.
- File names without ".jpg" extension will not be able to be read by this DVD player. Even though the files are shown as JPEG image files in windows explorer.

## Programmed Playback

### Programmed Playback with Audio CD and MP3/WMA disc

The Program function enables you to store your favorite tracks from any disc in the player memory.

Program can contain 30 tracks.

#### 1 Press PROGRAM during playback or in the stop mode to enter the Program Edit mode.

The  mark will appear to the right of the word Program on the right side of the menu screen.

#### Note

Press PROGRAM to exit the Program Edit mode; the  mark will disappear.

#### 2 Select a track, then press ENTER to place the selected track on the Program list.

#### 3 Repeat step 2 to place additional tracks on the Program list.

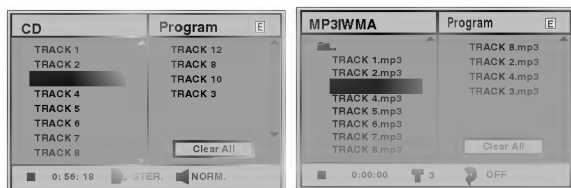

Audio CD menu

MP3/WMA menu

#### 4 Press ►.

The programmed track you selected last is highlighted on the program list.

#### 5 Press ▲/▼ to select the track you want to start playing.

Press TITLE to move to the next page.  
Press DISC MENU to move to the previous page.

#### 6 Press PLAY to start.

Playback begins in the order in which you programmed the tracks and "PROG." appears on the menu screen. Playback stops after all of the tracks on the Program list have played once.

#### 7 To resume normal playback from programmed playback, press PROGRAM to exit the Program Edit mode; the mark will disappear and select a track of CD (or MP3/WMA) list and then press ENTER.

"PROG." indicator disappears on the menu screen.

### Programmed Playback with Video CD

#### Note

On a Video CD with PBC, you must set PBC to Off on the setup menu to use the Program function. See page 14.

#### 1 Insert Video CD and close the tray.

#### 2 Press PROGRAM while playback is stopped.

The VCD Program menu will appear.

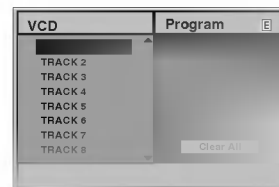

#### Note

Press RETURN or PROGRAM to exit the Program menu.

#### 3 Follow steps 2-6 of "Programmed Playback with Audio CD and MP3/WMA disc" on left.

#### 4 To resume normal playback from programmed playback, press PROGRAM.

"NORMAL" appears on the TV screen.

### Repeat Programmed Tracks

- To repeat the track currently playing, press REPEAT. The Repeat icon and "TRACK" appears on the menu screen.
- To repeat all tracks on the program list, press REPEAT a second time. The Repeat icon and "ALL" appears on the menu screen.
- To cancel Repeat mode, press REPEAT a third time. The Repeat icon and "OFF" appears on the menu screen.

### Erasing a Track from Program List

- 1 Press PROGRAM during playback (Audio CD and MP3/WMA disc only) or in the stop mode to enter the Program Edit mode.  
The  mark will appear.
- 2 Press ► to move to the Program list.
- 3 Use ▲/▼ to select the track that you wish to erase from the Program list.
- 4 Press CLEAR.  
The track will be erased from the Program list.

### Erasing the Complete Program List

- 1 Follow steps 1-2 of "Erasing a Track from Program List" as above.
- 2 Use ▲/▼ to select "Clear All", then press ENTER.  
The complete Program for the disc will be erased.  
The programs are also cleared when the disc is removed.



## Additional Operation - VCR part

### On Screen Display

You may easily display the current time or tape counter and amount of tape left, day, month, year, day of week, operating mode, tape speed, and audio output channel of your VCR on the TV screen. If a recording is taking place these On Screen Displays will not be recorded onto the tape.

**1** Press **CLK/CNT** to display.  
Press **CLK/CNT** repeatedly to cycle through the display options. The tape counter and amount of tape left will appear if there is a tape loaded.

**2** After 3 seconds the majority of the On Screen Displays will clear leaving only the clock or tape counter and the amount of tape left on the screen. Press **CLK/CNT** again to remove all displays from the TV screen.

### Tape Counter Memory Stop

The **Digital Tape Counter** can be displayed on the display window instead of the time by pressing **CLK/CNT** on the remote control. The Digital Tape Counter indicates the relative positions of recordings on the tape.

**1** Press **CLK/CNT**.  
Press **CLEAR** to set the counter to M 0:00:00.  
Press **PLAY** or start recording.  
The tape counter will display the actual play time in hours, minutes and seconds.

**2** Press **STOP** when playback or recording is complete.  
Press **BACKWARD**.  
The tape will rewind and automatically stop when the counter returns to 0:00:00.

### Lock (Child Lock)

The control buttons on the front of the unit can be switched off so that your unit can only be operated using the remote control.

**1** Press **LOCK**.  
**On** and **SAFE** will appear in the display window. None of the buttons on the front of your unit will work.  
If any buttons on the front of your unit are pressed **SAFE** will flicker in the display window for a few seconds.

**2** Press **LOCK** again to switch off the child lock.  
**OFF** will appear in the display window.

### Video Doctor (Self-Diagnosis)

This feature informs you that there is a problem with your VCR. These error messages will appear on the TV screen.

**1** Press **i**.  
Press **◀** or **▶** to select **Dr.**  
Press **OK**.



**2** Press **▲** or **▼** to check a problem.  
**HEAD STATUS**  
● **OK**  
● **PLEASE CLEAN:**  
Clean your video heads.

**TAPE STATUS**  
● **RECORDABLE**  
● **NOT RECORDABLE:**  
Insert a tape with its protection tab in place.

**3** Press **i** to remove menus from the TV screen.

### Hi-Fi Stereo Sound System

Press **AUDIO** repeatedly until the desired audio mode appears.

The choice is **STEREO**, **LEFT**, **RIGHT** and **MONO**.

## Additional Operation-DVD part

### Last Condition Memory



This player memorizes the user settings for the last disc that you have viewed. Settings remain in memory even if you remove the disc from the player or switch off the player. If you load a disc that has its settings memorized, the latest stop position is automatically recalled.

#### Notes

- Settings are stored in memory for use any time.
- This player does not memorize settings of a disc if you switch off the player before commencing to play it.

### Screen Saver

The screen saver picture appears when you leave the DVD Player in stop mode for about five minutes.



## Special Recording

### Copying from DVD To VCR

This unit allows you to copy the contents of a DVD to a VHS tape with a press of the COPY button.

#### Note

- If the DVD you are attempting to copy is copy protected, you may not be able to copy the disc.

#### **1** Insert Disc

Insert the disc you wish to copy in the DVD deck and close the disc tray.

#### **2** Insert VHS Tape

Insert a blank VHS video tape into the VCR deck.

#### **3** Copy the DVD to VHS Tape

Press the COPY button on the unit front panel or press the REC/ITR button.

- The DVD will go into Play mode and the VCR will go into Record mode.
- If the DVD disc menu appears, you may need to press the Play button manually to begin copying.

#### Note

If you press the REC/ITR button, be sure this unit is in DVD mode.

#### **4** Stop the Copy Process

When the DVD is finished playing, press the STOP button to end the copy.

- You must stop the Copy process manually when the DVD movie ends, or the unit may replay and record over and over again.

### Recording from another video player

With this video player you can make recordings from an external source, such as copying from another video player or a camcorder.

#### Note

In the following description, this video player will be one used for recording and will be referred to as VCR B. The other appliance will be used for playback and will be referred to as VCR A.

**1** VCR A should be connected to the **AUDIO (L/R)/ VIDEO (VCR IN AV1)** on the rear panel of this unit or **AUDIO IN(L(MONO)/R)/VIDEO IN** on the front of this unit.

**2** Insert the recorded tape into VCR A and a blank tape into VCR B.

**3** Press AV until the socket you wish to record from is displayed. (VCR B)

**AV 1** for recording from **AUDIO (L/R)/ VIDEO (VCR IN AV1)** terminals on the rear of your unit.

**AV 2** for recording from **AUDIO IN (L(MONO)/R)/ VIDEO IN** terminals on the front of your unit.

**4** To start recording, press the REC/ITR on VCR B and PLAY on VCR A.

**5** When you want to finish copying, press the STOP on both video players.

## Controlling Your TV with the Supplied Remote Control

You can control the sound level, input source, and power switch of your LG TV with the supplied remote control.

You can control your TV using the buttons below.

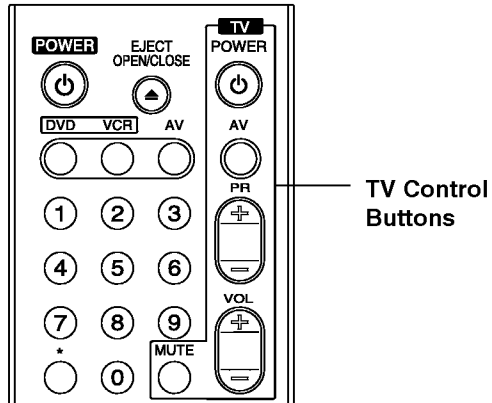

By pressing	You can
TV POWER	Turns the TV on or off.
TV AV	Switch the TV's input source between the TV and other input sources.
TV PR +/-	Scans up or down through memorized channels.
TV VOL +/-	Adjust the volume of the TV.
MUTE	Turns on or off TV sound

## Controlling other TVs with the remote control

You can control the sound level, input source, and power switch of non-LG TVs as well. If your TV is listed in the table below, set the appropriate manufacturer code.

1. While holding down TV POWER button, press the number buttons to select the manufacturer code for your TV (see the table below).
2. Release TV POWER button.

### Code numbers of controllable TVs

If more than one code number is listed, try entering them one at a time until you find the one that works with your TV.

Manufacturer	Code Number
LG / GoldStar	1 (Default), 2
Zenith	1, 3, 4
Samsung	6, 7
Sony	8, 9
Hitachi	4

### Notes

- Depending on your TV, some or all buttons may not function on the TV, even after entering the correct manufacturer code.
- If you enter a new code number, the code number previously entered will be erased.
- When you replace the batteries of the remote, the code number you have set may be reset to the default setting. Set the appropriate code number again.

## Troubleshooting

Check the following guide for the possible cause of a problem before contacting service.

Symptom	Cause	Correction
DVD or VCR do not work properly.	<ul style="list-style-type: none"> <li>DVD or VCR button is not switched properly.</li> </ul>	<ul style="list-style-type: none"> <li>Refer to page 2.</li> </ul>
No power.	<ul style="list-style-type: none"> <li>The power cord is disconnected.</li> </ul>	<ul style="list-style-type: none"> <li>Plug the power cord into the wall outlet securely.</li> </ul>
The power is on, but the DVD player does not work.	<ul style="list-style-type: none"> <li>No disc is inserted.</li> </ul>	<ul style="list-style-type: none"> <li>Insert a disc.</li> </ul>
No picture.	<ul style="list-style-type: none"> <li>The TV is not set to receive DVD signal output.</li> </ul>	<ul style="list-style-type: none"> <li>Select the appropriate video input mode on the TV so the picture from the DVD player appears on the TV screen.</li> </ul>
No sound.	<ul style="list-style-type: none"> <li>The equipment connected with the audio cable is not set to receive DVD signal output.</li> </ul>	<ul style="list-style-type: none"> <li>Select the correct input mode of the audio receiver so you can listen to the sound from the DVD player.</li> </ul>
	<ul style="list-style-type: none"> <li>The audio cables are not connected securely.</li> </ul>	<ul style="list-style-type: none"> <li>Connect the audio cable into the jacks securely.</li> </ul>
	<ul style="list-style-type: none"> <li>The power of the equipment connected with the audio cable is turned off.</li> </ul>	<ul style="list-style-type: none"> <li>Turn on the equipment connected with the audio cable.</li> </ul>
	<ul style="list-style-type: none"> <li>The Digital Audio Output is set to the wrong position.</li> </ul>	<ul style="list-style-type: none"> <li>Set the Digital Audio Output to the correct position, then turn on the DVD player again by pressing POWER.</li> </ul>
The picture is poor.	<ul style="list-style-type: none"> <li>The disc is dirty.</li> </ul>	<ul style="list-style-type: none"> <li>Clean the disc.</li> </ul>
The DVD player does not start playback.	<ul style="list-style-type: none"> <li>An unplayable disc is inserted.</li> </ul>	<ul style="list-style-type: none"> <li>Insert a playable disc. (Check the disc type, color system and Regional code.)</li> </ul>
	<ul style="list-style-type: none"> <li>The disc is placed upside down.</li> </ul>	<ul style="list-style-type: none"> <li>Place the disc with the playback side down.</li> </ul>
	<ul style="list-style-type: none"> <li>The disc is not placed within the guide.</li> </ul>	<ul style="list-style-type: none"> <li>Place the disc on the disc tray correctly inside the guide.</li> </ul>
	<ul style="list-style-type: none"> <li>The disc is dirty.</li> </ul>	<ul style="list-style-type: none"> <li>Clean the disc.</li> </ul>
	<ul style="list-style-type: none"> <li>The Rating level is set.</li> </ul>	<ul style="list-style-type: none"> <li>Cancel the Rating function or change the rating level.</li> </ul>
The remote control does not work properly.	<ul style="list-style-type: none"> <li>There is an obstacle in the path of the remote control and this unit.</li> </ul>	<ul style="list-style-type: none"> <li>Remove the obstacle.</li> </ul>
	<ul style="list-style-type: none"> <li>The batteries in the remote control are exhausted.</li> </ul>	<ul style="list-style-type: none"> <li>Replace the batteries with new ones.</li> </ul>
Video tape cannot be inserted.	<ul style="list-style-type: none"> <li>Is the cassette compartment empty?</li> </ul>	<ul style="list-style-type: none"> <li>Eject the tape in.</li> </ul>
No Hi-Fi sound	<ul style="list-style-type: none"> <li>Audio mode is not set properly.</li> </ul>	<ul style="list-style-type: none"> <li>Select "STEREO" by repeatedly pressing "AUDIO" on the remote control.</li> </ul>

### Video Head Cleaning

Whenever a video cassette is inserted into or ejected from your VCR the video head is automatically cleaned. This should mean that additional head cleaning should not be necessary. However dirt accumulating on the head after a long period of time can cause the playback picture to become blurred or broken up. High quality video cassette tapes will not normally deposit dirt onto the video head, but old or damaged tapes might.

## Language Code List

Enter the appropriate code number for the initial settings "Disc Audio", "Disc Subtitle" and/or "Disc Menu"  
(See page 13).

Code	Language	Code	Language	Code	Language	Code	Language
6565	Afar	7079	Faroese	7678	Lingala	8375	Slovak
6566	Abkhazian	7082	French	7679	Laothian	8376	Slovenian
6570	Afrikaans	7089	Frisian	7684	Lithuanian	8377	Samoan
6577	Ameharic	7165	Irish	7686	Latvian, Lettish	8378	Shona
6582	Arabic	7168	Scots Gaelic	7771	Malagasy	8379	Somali
6583	Assamese	7176	Galician	7773	Maori	8381	Albanian
6588	Aymara	7178	Guarani	7775	Macedonian	8382	Serbian
6590	Azerbaijani	7185	Gujarati	7776	Malayalam	8385	Sudanese
6665	Bashkir	7265	Hausa	7778	Mongolian	8386	Swedish
6669	Byelorussian	7273	Hindi	7779	Moldavian	8387	Swahili
6671	Bulgarian	7282	Croatian	7782	Marathi	8465	Tamil
6672	Bihari	7285	Hungarian	7783	Malay	8469	Telugu
6678	Bengali; Bangla	7289	Armenian	7784	Maltese	8471	Tajik
6679	Tibetan	7365	Interlingua	7789	Burmese	8472	Thai
6682	Breton	7378	Indonesian	7865	Nauru	8473	Tigrinya
6765	Catalan	7383	Icelandic	7869	Nepali	8475	Turkmen
6779	Corsican	7384	Italian	7876	Dutch	8476	Tagalog
6783	Czech	7387	Hebrew	7879	Norwegian	8479	Tonga
6789	Welsh	7465	Japanese	7982	Oriya	8482	Turkish
6865	Danish	7473	Yiddish	8065	Panjabi	8484	Tatar
6869	German	7487	Javanese	8076	Polish	8487	Twi
6890	Bhutani	7565	Georgian	8083	Pashto, Pushto	8575	Ukrainian
6976	Greek	7575	Kazakh	8084	Portuguese	8582	Urdu
6978	English	7576	Greenlandic	8185	Quechua	8590	Uzbek
6979	Esperanto	7577	Cambodian	8277	Rhaeto-Romance	8673	Vietnamese
6983	Spanish	7578	Kannada	8279	Rumanian	8679	Volapük
6984	Estonian	7579	Korean	8285	Russian	8779	Wolof
6985	Basque	7583	Kashmiri	8365	Sanskrit	8872	Xhosa
7065	Persian	7585	Kurdish	8368	Sindhi	8979	Yoruba
7073	Finnish	7589	Kirghiz	8372	Serbo-Croatian	9072	Chinese
7074	Fiji	7665	Latin	8373	Singhalese	9085	Zulu

## Country Code List

Enter the appropriate code number for the initial setting "Country Code" (See page 15).

Code	Country	Code	Country	Code	Country	Code	Country
AD	Andorra	ER	Eritrea	LC	Saint Lucia	SC	Seychelles
AE	United Arab Emirates	ES	Spain	LI	Liechtenstein	SD	Sudan
AF	Afghanistan	ET	Ethiopia	LK	Sri Lanka	SE	Sweden
AG	Antigua and Barbuda	FI	Finland	LR	Liberia	SG	Singapore
AI	Anguilla	FJ	Fiji	LS	Lesotho	SH	Saint Helena
AL	Albania	FK	Falkland Islands	LT	Lithuania	SI	Slovenia
AM	Armenia	FM	Micronesia	LU	Luxembourg	SJ	Svalbard and Jan Mayen Islands
AN	Netherlands Antilles	FO	Faroe Islands	LV	Latvia	SK	Slovak Republic
AO	Angola	FR	France	LY	Libya	SL	Sierra Leone
AQ	Antarctica	FX	France (European Territory)	MA	Morocco	SM	San Marino
AR	Argentina	GA	Gabon	MC	Monaco	SN	Senegal
AS	American Samoa	GB	Great Britain	MD	Moldavia	SO	Somalia
AT	Austria	GD	Grenada	MG	Madagascar	SR	Suriname
AU	Australia	GE	Georgia	MH	Marshall Islands	ST	Saint Tome and Principe
AW	Aruba	GF	French Guyana	MK	Macedonia	SU	Former USSR
AZ	Azerbaijan	GH	Ghana	ML	Mali	SV	El Salvador
BA	Bosnia-Herzegovina	GI	Gibraltar	MM	Myanmar	SY	Syria
BB	Barbados	GL	Greenland	MN	Mongolia	SZ	Swaziland
BD	Bangladesh	GM	Gambia	MO	Macau	TC	Turks and Caicos Islands
BE	Belgium	GN	Guinea	MP	Northern Mariana Islands	TD	Chad
BF	Burkina Faso	GP	Guadeloupe (French)	MQ	Martinique (French)	TF	French Southern Territories
BG	Bulgaria	GQ	Equatorial Guinea	MR	Mauritania	TG	Togo
BH	Bahrain	GR	Greece	MS	Montserrat	TH	Thailand
BI	Burundi	GS	S. Georgia & S. Sandwich Isls.	MT	Malta	TJ	Tadjikistan
BJ	Benin	GT	Guatemala	MU	Mauritius	TK	Tokelau
BM	Bermuda	GU	Guam (USA)	MV	Maldives	TM	Turkmenistan
BN	Brunei Darussalam	GW	Guinea Bissau	MX	Mexico	TN	Tunisia
BO	Bolivia	GY	Guyana	MY	Malaysia	TO	Tonga
BR	Brazil	HK	Hong Kong	MZ	Mozambique	TP	East Timor
BS	Bahamas	HM	Heard and McDonald Islands	NA	Namibia	TR	Turkey
BT	Bhutan	HN	Honduras	NC	New Caledonia (French)	TT	Trinidad and Tobago
BV	Bouvet Island	HR	Croatia	NE	Niger	TV	Tuvalu
BW	Botswana	HT	Haiti	NF	Norfolk Island	TW	Taiwan
BY	Belarus	HU	Hungary	NG	Nigeria	TZ	Tanzania
BZ	Belize	ID	Indonesia	NI	Nicaragua	UA	Ukraine
CA	Canada	IE	Ireland	NL	Netherlands	UG	Uganda
CC	Cocos (Keeling) Islands	IL	Israel	NO	Norway	UK	United Kingdom
CF	Central African Republic	IN	India	NP	Nepal	UM	USA Minor Outlying Islands
CG	Congo	IO	British Indian Ocean Territory	NR	Nauru	US	United States
CH	Switzerland	IQ	Iraq	NU	Niue	UY	Uruguay
CI	Ivory Coast	IR	Iran	NZ	New Zealand	UZ	Uzbekistan
CK	Cook Islands	IS	Iceland	OM	Oman	VA	Vatican City State
CL	Chile	IT	Italy	PA	Panama	VC	Saint Vincent & Grenadines
CM	Cameroon	JM	Jamaica	PE	Peru	VE	Venezuela
CN	China	JO	Jordan	PF	Polynesia (French)	VG	Virgin Islands (British)
CO	Colombia	JP	Japan	PG	Papua New Guinea	VI	Virgin Islands (USA)
CR	Costa Rica	KE	Kenya	PH	Philippines	VN	Vietnam
CS	Former Czechoslovakia	KG	Kyrgyzstan	PK	Pakistan	VU	Vanuatu
CU	Cuba	KH	Cambodia	PL	Poland	WF	Wallis and Futuna Islands
CV	Cape Verde	KI	Kiribati	PM	Saint Pierre and Miquelon	WS	Samoa
CX	Christmas Island	KM	Comoros	PN	Pitcairn Island	YE	Yemen
CY	Cyprus	KN	Saint Kitts & Nevis Anguilla	PR	Puerto Rico	YT	Mayotte
CZ	Czech Republic	KP	North Korea	PT	Portugal	YU	Yugoslavia
DE	Germany	KR	South Korea	PW	Palau	ZA	South Africa
DJ	Djibouti	KW	Kuwait	PY	Paraguay	ZM	Zambia
DK	Denmark	KY	Cayman Islands	QA	Qatar	ZR	Zaire
DM	Dominica	KZ	Kazakhstan	RE	Reunion (French)	ZW	Zimbabwe
DO	Dominican Republic	LA	Laos	RO	Romania		
DZ	Algeria	LB	Lebanon	RU	Russian Federation		
EC	Ecuador			RW	Rwanda		
EE	Estonia			SA	Saudi Arabia		
EG	Egypt			SB	Solomon Islands		
EH	Western Sahara						

## Specification

### General

Power requirements	AC 110-240V , 50/60 Hz
Power consumption	19W
Dimensions (approx.)	430 X 78 X 265 mm (w/h/d)
Mass (approx.)	4.2 kg
Operating temperature	5° C to 35° C (41° F to 95° F)
Operating humidity	5 % to 90 %

### System

Laser	Semiconductor laser, wavelength 650 nm
Video Head system	Double azimuth 4 heads, helical scanning.
Signal system	PAL
Frequency response	DVD (PCM 96 kHz): 8 Hz to 44 kHz DVD (PCM 48 kHz): 8 Hz to 22 kHz CD: 8 Hz to 20 kHz
Signal-to-noise ratio	More than 100dB (ANALOG OUT connectors only)
Harmonic distortion	Less than 0.008%
Dynamic range	More than 100 dB (DVD) More than 95 dB (CD)

### Inputs (VCR)

Audio	-6.0dBm, more than 47 kohms
Video	1.0 Vp-p, 75 ohms, unbalanced

### Outputs (DVD)

S-VIDEO OUT	(Y) 1.0 V (p-p), 75 Ω, negative sync., Mini DIN 4-pin x 1 (C) 0.3 V (p-p), 75 ohms
Audio output (digital audio)	0.5 V (p-p), 75 Ω, RCA jack x 1
Audio output (analog audio)	2.0 Vrms (1 KHz, 0 dB), 600 Ω, RCA jack (L, R)

### Outputs (VCR/DVD)

Audio	-6.0dBm, less than 1 kohms
Video	1.0 Vp-p, 75 ohms, unbalanced

- Design and specifications are subject to change without notice.

Manufactured under license from Dolby Laboratories. "Dolby", "Pro Logic", and the double-D symbol are trademarks of Dolby Laboratories.

"DTS" and "DTS Digital Out" are trademarks of Digital Theater Systems, Inc.





P/NO : 3834RV0021J