

User's Guide

L3020A

Make sure to read the **Safety Precautions** before using the product.

Keep the User's Guide(CD) in an accessible place for future reference.

See the label attached on the back cover and quote this information to your dealer when you require service.

Table of Contents

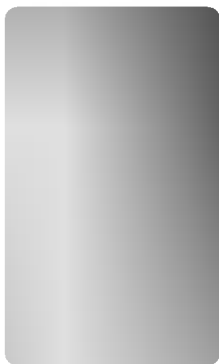

.....
Safety Precautions

.....
Accessories

.....
Important Monitor Features

.....
Name and Function of the Parts

.....
Connecting to External Devices

Connecting to your PC

Watching Video/DVD

Watching DVD (576i)

Watching HDTV (576i)

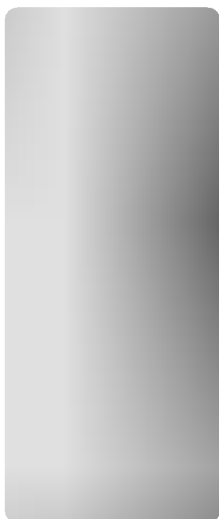

.....
Name of the Buttons in the screen Adjustment Unit

.....
OSD (On Screen Display) Screen Tracking Order

.....
When Connected to your PC

Adjusting Screen Color

Adjusting Screen CLOCK/PHASE and Position

Adjusting the audio function

Adjusting Options

.....
Adjusting PIP/POP/PBP Mode Functions

.....
When Watching Video/DVD/HDTV

Adjusting Screen Image

Adjusting the audio function

Adjusting Options

.....
Adjusting PIP/POP/PBP Mode Functions

.....
Adjusting Functions using your PC



.....
Troubleshooting

.....
Product Specifications

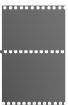



is a trademark of SRS Labs, Inc.

technology is incorporated under license from SRS Labs, Inc.



Please read these safety precautions carefully before using the monitor.

 **Warning** If you ignore the warning message, you may be seriously injured or there is a possibility of accident or death.

 **Caution** If you ignore the caution message, you may be slightly injured or the product may be damaged

Precautions in installing the Monitor

Warning

- **Keep away from heat sources like electrical heaters.**
 - Electrical shock, fire, malfunction or deformation may occur.
- **Keep the packing anti-moisture material or vinyl packing out of the reach of children.**
 - Anti-moisture material is harmful if swallowed. If swallowed by mistake, force the patient to vomit and visit the nearest hospital. Additionally, vinyl packing can cause suffocation. Keep it out of the reach of children.
- **Do not put heavy objects on the monitor or sit upon it.**
 - If the monitor collapses or is dropped, you may be injured. Children must pay particular attention.
- **Do not leave the power or signal cable unattended on the pathway.**
 - The passerby can falter, which can cause electrical shock, fire, product breakdown or injury.
- **Install the monitor in a neat and dry place.**
 - Dust or moisture can cause electrical shock, fire or product damage.
- **If you can smell smoke or other odors or hear a strange sound unplug the power cord and contact the service center.**
 - If you continue to use without taking proper measures, electrical shock or fire can occur.
- **If you dropped the monitor or the case is broken, turn off the monitor and unplug the power cord.**
 - If you continue to use without taking proper measures, electrical shock or fire can occur. Contact the service center.
- **Do not drop metallic objects such as coins, hair pins, chopsticks or wire into the monitor, or inflammable objects such as paper and matches. Children must pay particular attention.**
 - Electrical shock, fire or injury can occur. If a foreign object is dropped into the monitor, unplug the power cord and contact the service center.

Caution

- **Make sure the monitor ventilation hole is not blocked. Install the monitor in a suitably wide place (more than 10cm from the wall)**
 - If you install the monitor too close to the wall, it may be deformed or fire can break out due to internal heat.
- **Do not block the ventilation hole of the monitor by a tablecloth or curtain.**
 - The monitor can be deformed or fire can break out due to overheating inside the monitor.
- **Install the monitor on a flat and stable place that has no risk of dropping the monitor.**
 - If the monitor is dropped, you may be injured or the monitor may be broken.
- **Install the monitor where no EMI occurs.**
- **Keep the monitor away from direct sunlight.**
 - The monitor can be damaged.

Electrical Power Related Precautions

Warning

- **Make sure to connect the power cable to the grounded current.**
 - You may be electrocuted or injured.
- **Use the rated voltage only.**
 - The monitor can be damaged, or you may be electrocuted.
- **During a thunder or lightning storm, unplug the power cable or signal cable.**
 - You may be electrocuted or a fire can break out.
- **Do not connect several extension cords, electrical appliances or electrical heaters to a single outlet. Use a power bar with a grounding terminal designed for exclusive use with the computer.**
 - A fire can break out due to overheating.
- **Do not touch the power plug with wet hands. Additionally, if the cord pin is wet or covered with dust, dry the power plug completely or wipe dust off.**
 - You may be electrocuted due to excess moisture.
- **If you don't intend to use the monitor for a long time, unplug the power cable from the monitor.**
 - Covering dust can cause a fire, or insulation deterioration can cause electric leakage, electric shock or fire.
- **Fix the power cable completely.**
 - If the power cable is not fixed completely, a fire can break out.
- **Hold the plug when pulling out the power cable. Do not bend the power cord with excessive force or put heavy objects on the power cord.**
 - The power line can be damaged, which may cause electric shock or fire.
- **Do not insert a conductor (like a metal chopstick) into one end of the power cable while the other end is connected to the input terminal on the wall. Additionally, do not touch the power cable right after plugging into the wall input terminal.**
 - You may be electrocuted.

Caution

- **Do not unplug the power cord while the monitor is in use.**
 - Electrical shock can damage the monitor.

Precautions in Moving the Monitor

Warning

- **Make sure to turn off the monitor.**
 - You may be electrocuted or the monitor can be damaged.
 - **Make sure to remove all cables before moving the monitor.**
 - You may be electrocuted or the monitor can be damaged.
- 

 **Caution**

- **Do not shock the monitor when moving it.**
 - You may be electrocuted or the monitor can be damaged
 - **Do not dispose the product-packing box. Use it when you move.**
 - **Make the panel face forward and hold it with both hands to move.**
 - If you drop the monitor, the damaged monitor can cause electric shock or fire. Contact with the service center for repair.
-

 **Precautions in Using the Monitor** **Warning**

- **Do not disassemble, repair or modify the monitor at your own discretion.**
 - Fire or electric shock accident can occur.
 - Contact the service center for check, calibration or repair.
- **Do not spray water on the monitor or scrub with an inflammable substance (thinner or benzene). Fire or electric shock accident can occur**
- **Keep the monitor away from water.**
 - Fire or electric shock accident can occur.

 **Caution**

- **Do not put or store inflammable substances near the monitor.**
 - There is a danger of explosion or fire due careless handling of the inflammable substances.
 - **When cleaning the brown tube surface, unplug the power cord and scrub with soft cloth to prevent scratching. Do not clean with a wet cloth.**
 - The water can sink into the monitor, which can cause electric shock or serious malfunction.
 - **Take a rest from time to time to protect your vision.**
 - **Keep the monitor clean at all times.**
 - **Take a comfortable and natural position when working with a monitor to relax the muscles.**
 - **Take a regular break when working with a monitor for a long time.**
 - **Do not press strongly upon the panel with a hand or sharp object such as nail, pencil or pen, or make a scratch on it.**
 - **Keep the proper distance from the monitor.**
 - Your vision may be impaired if you look at the monitor too closely.
 - **Set the appropriate resolution and clock by referring to the User's Manual.**
 - Your vision can be impaired.
 - **Use authorized detergent only when cleaning the monitor. (Do not use benzene, thinner or alcohol.)**
 - Monitor can be deformed.
-



Please check the accessories in the product package.

* The monitor and the accessories can be different from the figures shown here.



Monitor



Remote Controller/Batteries (AAA x 2)

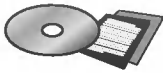

CD-ROM/Cards



15-pin D-Sub Signal Cable



DVI-D Signal Cable



Power Cord



RCA Cable and SCART Cable
-It varies from country/region to country/region.



S-Video Cable



Audio Cable (PC)

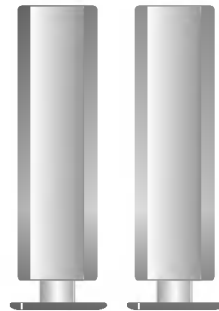

Speaker

Refer to the manual in the speaker box for more details on speaker accessories.

Important Monitor Features



Swapping Function

You can swap the main screen and the sub-screen when the PIP/POP/PBP function is used.



Spectacle Function

The screen center area is close to a 4:3 ratio and the outskirts area is expanded by more than 16:9. Therefore, the different screen ratio is applied for each area. Because most ordinary people concentrate their focus on the screen center, a non-linear ratio increase at the outskirts area is not recognized, which makes it possible to watch 4:3 screen with a wide screen.

However, the spectacle function is useful in watching motion pictures but is not suitable for the PC environment in which you perform graphic or document work.



Sleep Function

When watching AV/DVD/HDTV – The monitor will be automatically turned off after a certain period of time.

Press this button repetitively to select an appropriate time duration.



● Name of the Remote Controller Buttons

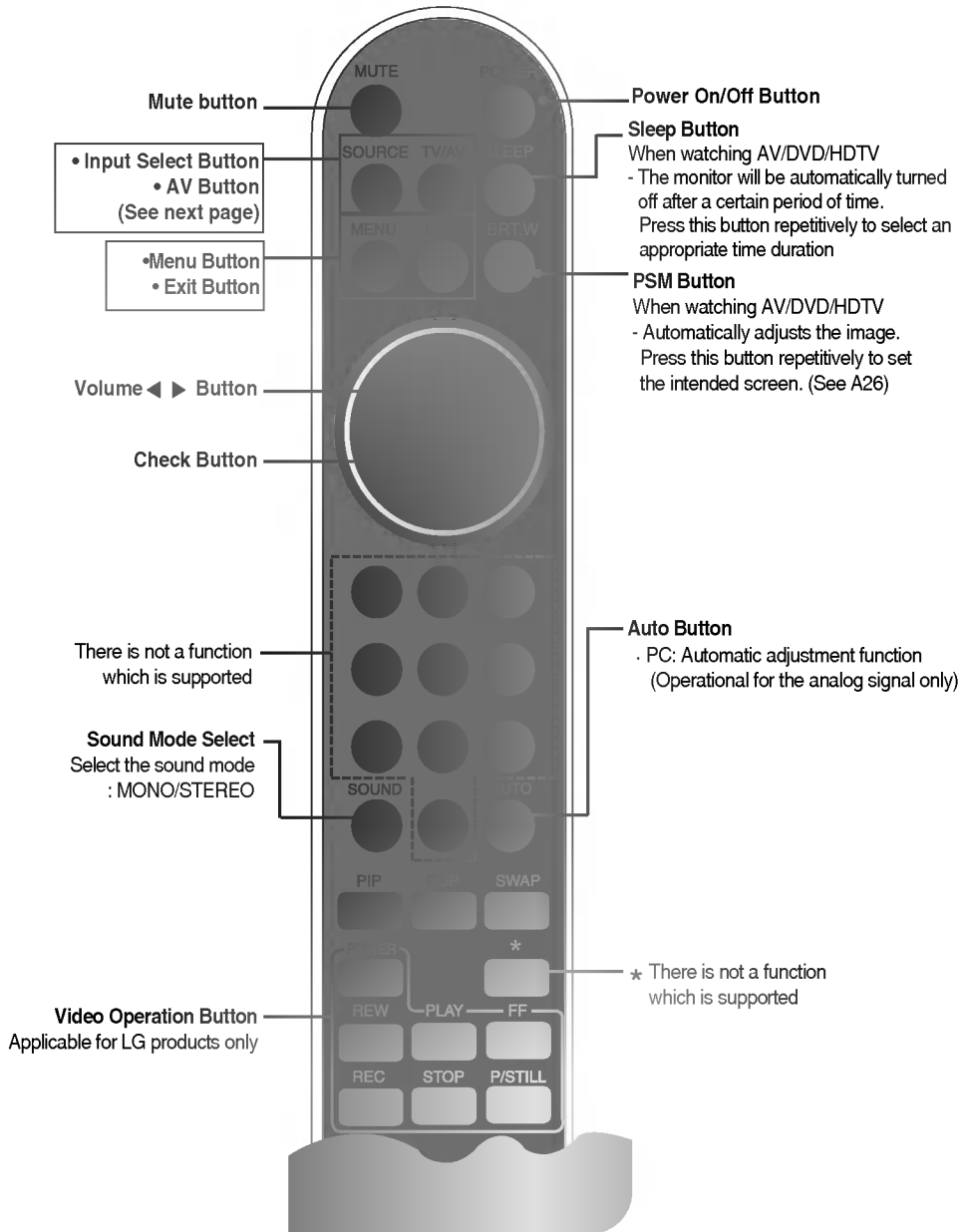

• **Input Select Button**

If you press the button once, the following Input Signal Window will appear. Select the signal type you want using the ▼ ▲ button.

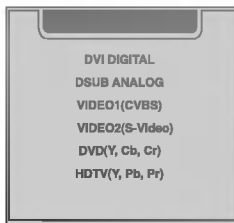

• **AV Button**

This button will be enabled only when you selected the AV signal. The signal type will be changed with the following order. Set the signal type you want.

VIDEO1 → VIDEO2 → DVD → HDTV

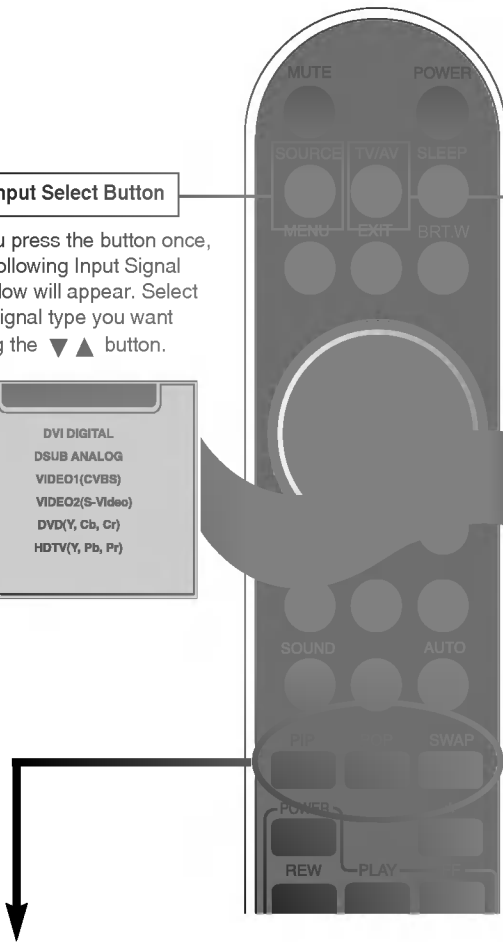

1. PIP (Picture in Picture) Button

The sub-screen moves to the next mode whenever you press this button.
: SMALL -> LARGE -> OFF

2. POP (Picture out Picture) Button

The sub-screen moves to the next mode whenever you press this button.
: POP ON -> PBP(FULL) -> PBP(4:3) -> OFF



POP ON



PBP (FULL)



PBP (4:3)



3. Swap Button

You can swap the main screen and the sub-screen when the PIP/POP/PBP function is used..

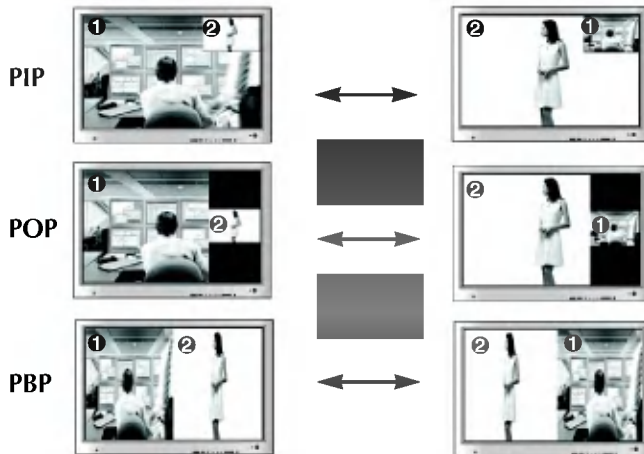

When 'Input Signal 1' comes on in the main screen, only 'Input Signal 2' can be displayed on the sub-screen. On the contrary, if the main screen displays 'Input Signal 2', the sub-screen can display 'Input Signal 1' only. You can swap 'Input Signal 1' and 'Input Signal 2' using the SWAP button.

<Table of PIP/POP/PBP Function Support>

Main Screen / Sub-Screen	DVI-D	D-SUB	VIDEO1	VIDEO2	DVD	HDTV
DVI-D	X	●	●	●	●	●
D-SUB	●	X	●	●	●	X
VIDEO1	●	●	X	X	X	●
VIDEO2	●	●	X	X	X	●
DVD	●	●	X	X	X	●
HDTV	●	X	●	●	●	X

Inserting batteries into remote controller.



1. Take out the battery cap.
2. Insert the battery with correct polarity (+/-).
3. Close the battery cap.
 - You can use a remote controller 7 meter distance and 30 degree (left/right) within the receiving unit scope.
 - Dispose of used batteries in the recycle bin to prevent environmental pollution.

● Rear View

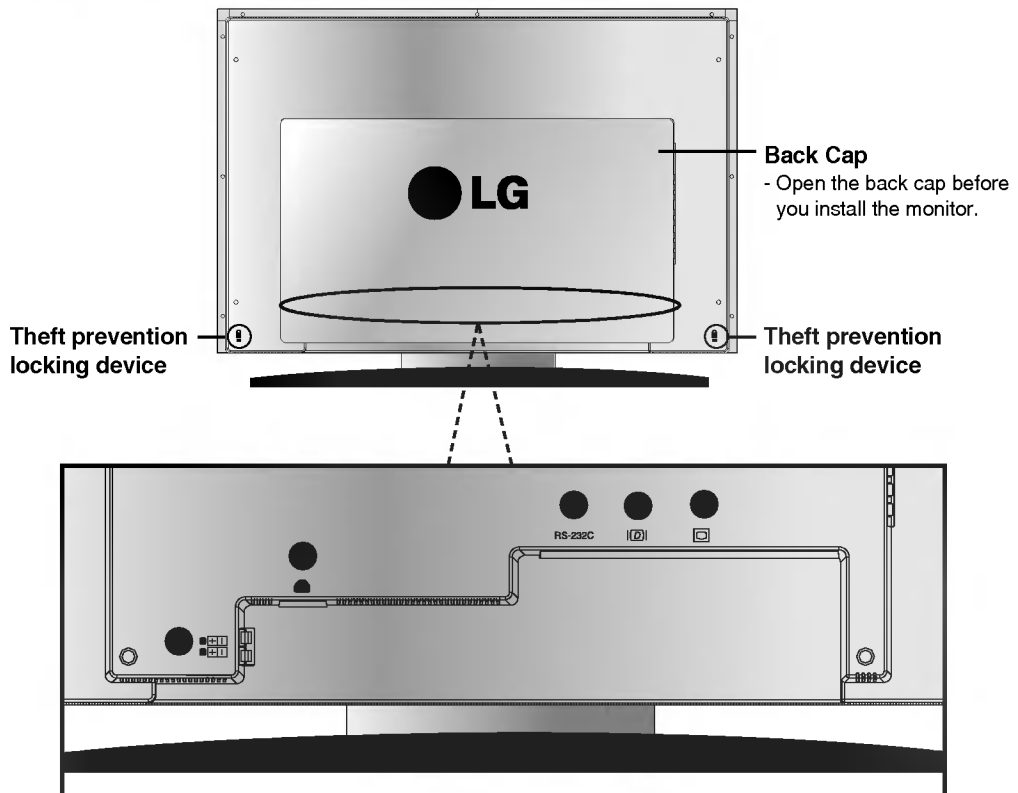

- ❶ RS-232C Terminal
- ❷ DVI Digital Signal Connector
- ❸ D-Sub Analog Signal Connector
- ❹ Connect the power cord.
- ❺ Speaker Terminal: Connect the speaker.



Side View

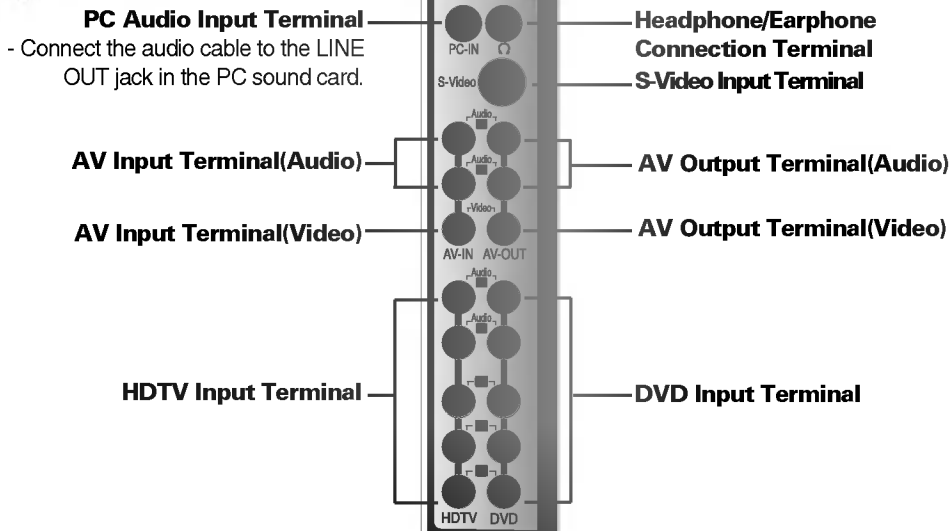

AV Output Terminal

Connect to the external device if you record the broadcasting.

- When you set the input signal of the main screen as 'VIDEO1 (CVBS)', you can transmit the signal that you're watching to the AV output terminal.
- If you set other signals than 'VIDEO1 (CVBS)', as the main screen, the signal type you set in the PIP input signal would be displayed. (However, it is supported when the PIP input signal is 'VIDEO1 (CVBS)')

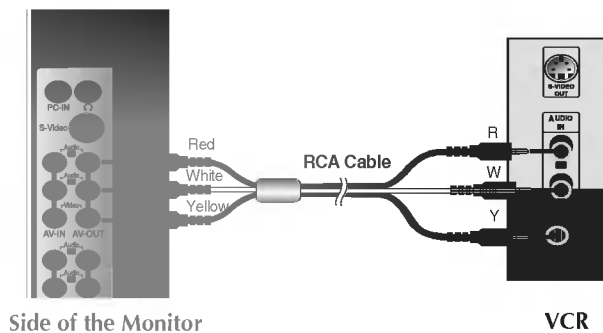

Connecting the sound card output terminal

- Make sure to check the sound card connection terminal in the PC before connecting to the monitor.
If the PC sound card supports both Speaker Out and Line Out, change it to Line Out by setting the jumper or the PC application. (For more details, refer to the sound card user's manual.)
 - **Speaker Out** : The terminal connected to the speaker that is not equipped with an amplifier.
 - ***Line Out** : The terminal connected to the speaker equipped with an amplifier.
- If Audio Out in the PC sound card has only Speaker Out, reduce the PC volume. This monitor is integrated with an amplifier.

1 First of all, see if the computer, monitor and the peripherals are turned off. Then, connect the signal input cable.

- (A)** When connecting with the DVI signal input cable.
- (B)** When connecting with the DSub signal input cable. (IBM compatible PC)
- (C)** When connecting with the DSub signal input cable. (Macintosh)

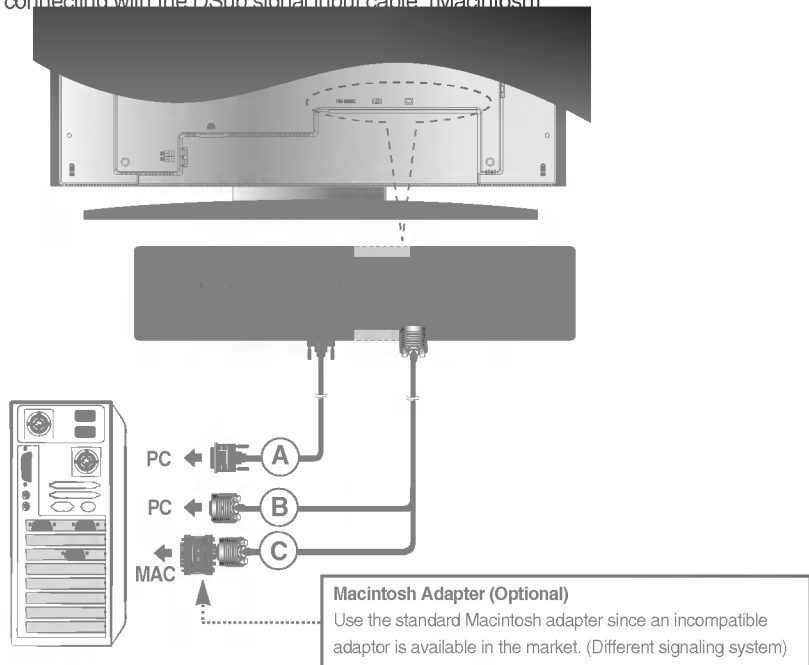

2 Connect the power cord.

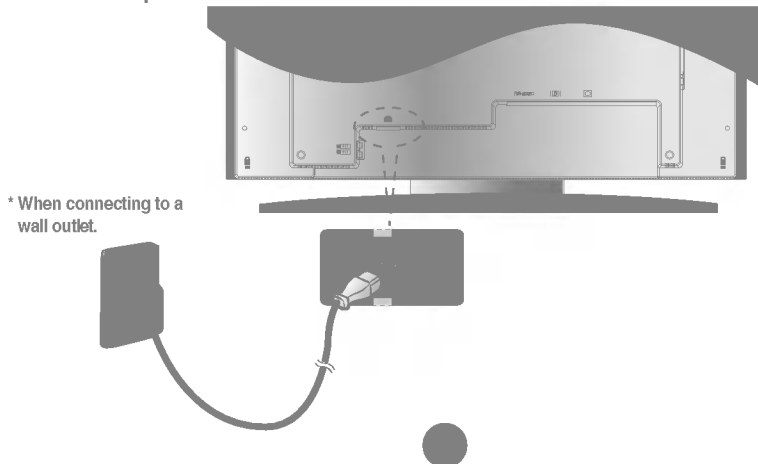

- 3 A Turn on power by pressing the power button on the monitor. If the system is not powered up, check if the main power switch is in the 'on' position.

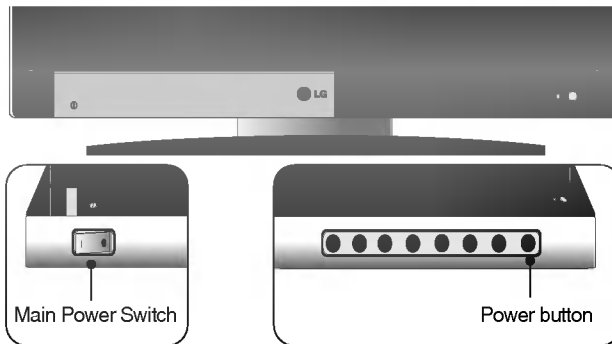

- B Turn on the PC.

- 4 Select an input signal.
Press the Input Select button on the remote controller to select the input signal.
Or, press the SOURCE button at the front side of the monitor.

SOURCE → ▼▲ → SET

- A When connecting with a DVI-D signal input cable.
• Select DVI DIGITAL: DVI-D digital signal.
- B When connecting with a D-Sub signal input cable.
• Select DSUB ANALOG: 15-pin D-Sub analog signal

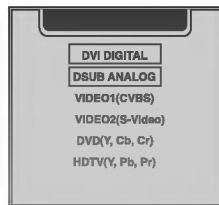

Note

- How to connect to two computers.
Connect the signal cables (DVI and D-Sub) to each computer.
Press the Input Select button in a remote controller to select the computer to use.
* Directly connect to a grounded power outlet on the wall or a power bar with a ground wire.

1 Connect the video cable as shown in the below figure and then connect the power cord (See page A11).

- (A)** When connecting with an RCA cable.
- Connect the input terminal with a proper color match. (**Video – Yellow, Sound (left) – White, Sound (right) – Red**)
- (B)** When connecting with an S-Video cable.
- Connect to the S-Video input terminal to watch high image quality movies.

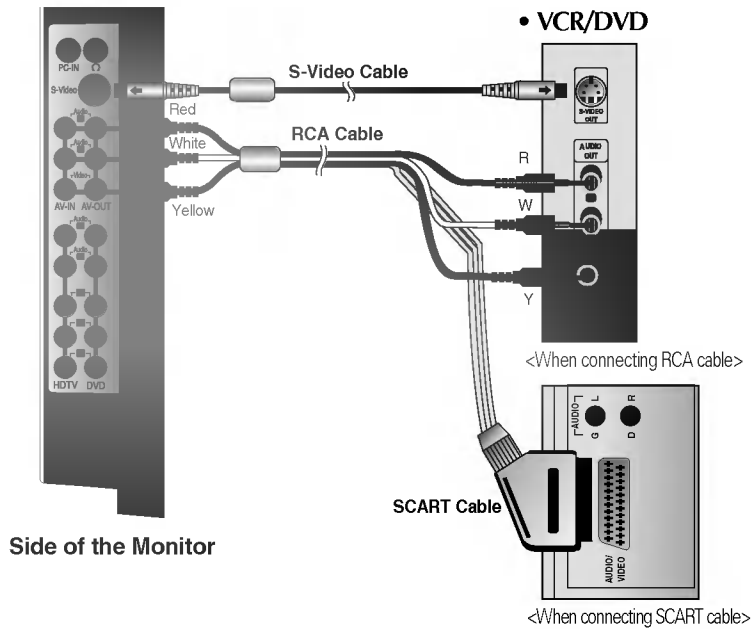

2 Select an input signal.
Press the Input Select button on the remote controller to select the input signal. Or, press the SOURCE button at the front side of the monitor.

SOURCE → ▼▲ → **SET**

- (A)** When connecting with a RCA cable.
- Select VIDEO 1 (CVBS).
- (B)** When connecting with a S-Video cable.
- Select VIDEO 2 (S-Video).

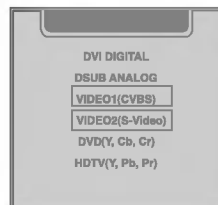

1 Connect the video/audio cable as shown in the below figure and then, connect the power cord (See page A11).

- Connect the input terminal with a proper color match.

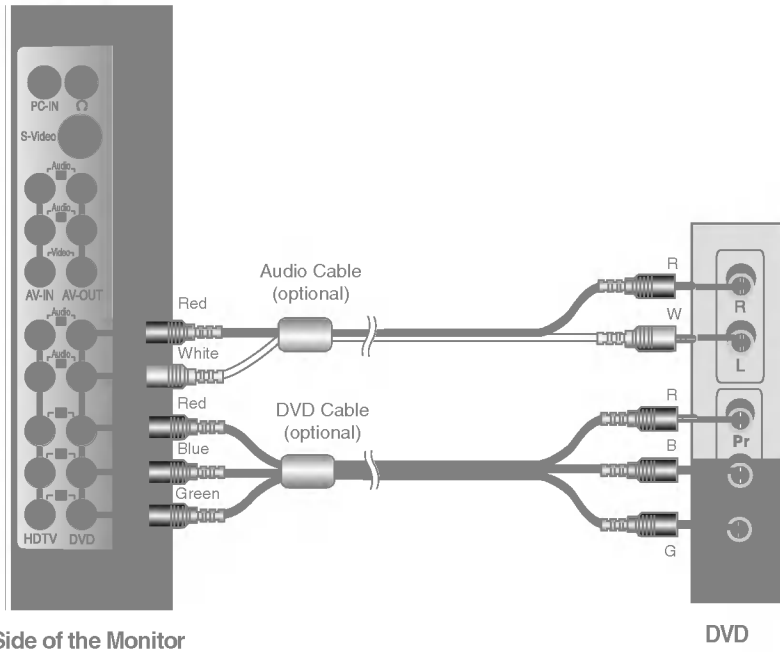

2 Select an input signal.
Press the Input Select button on the remote controller to select the input signal. Or, press the SOURCE button at the front side of the monitor.

SOURCE → ▼▲ → **SET**

When connecting with a DVD/audio cable.

- Select DVD (Y, Cb, Cr)

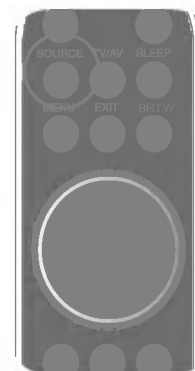
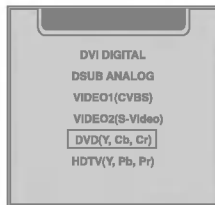

- 1 Connect the video/audio cable as shown in the below figure and then, connect the power cord (See page A11).
 - Connect the input terminal with a proper color match.

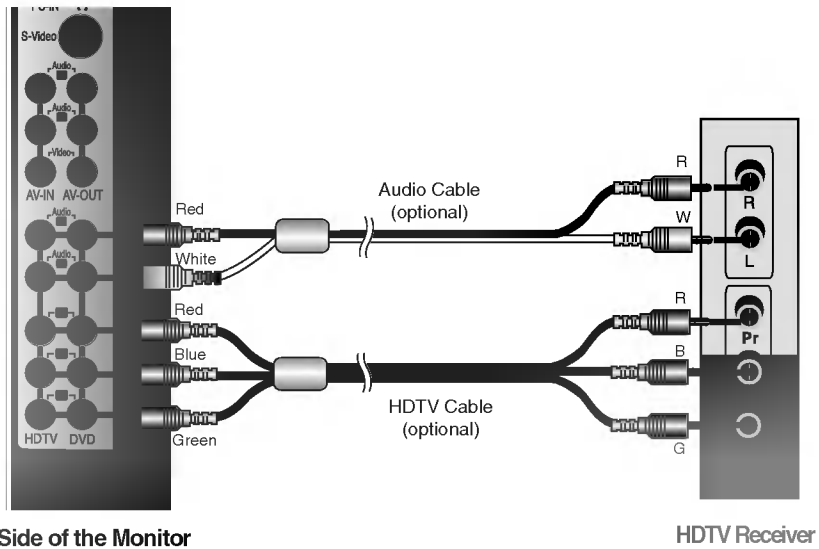

* The HDTV terminal also supports SDTV (480i/480p).

- 2 Select an input signal.
Press the Input Select button on the remote controller to select the input signal. Or, press the SOURCE button at the front side of the monitor.

SOURCE → ▼▲ → **SET**

When connecting with an HDTV/audio cable.

- Select HDTV (Y, Pb, Pr)

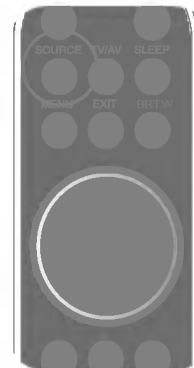
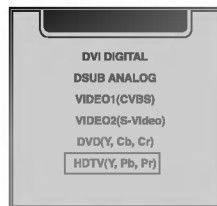

● Name of the Buttons in the Screen Adjustment Unit

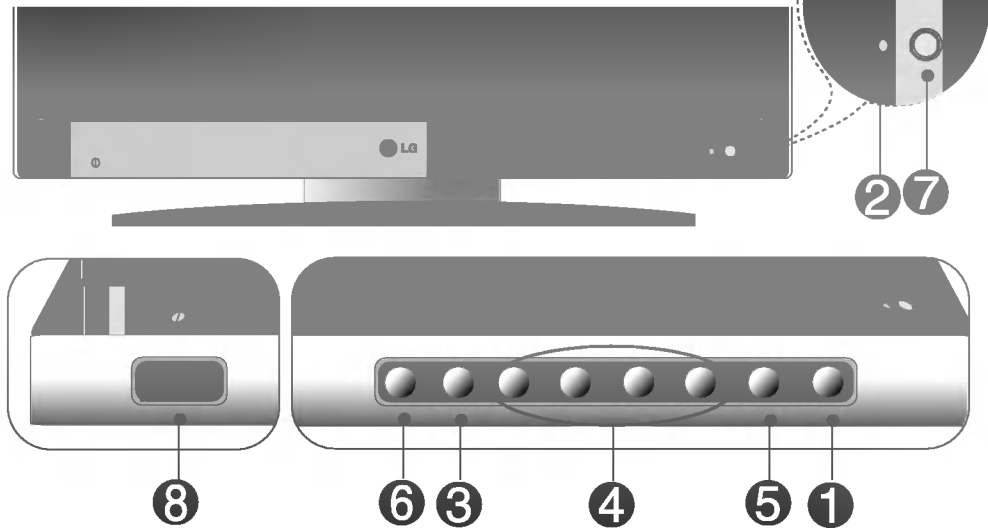

1

Power Button

- Press the button to turn on the power. Press the button again to turn it off.

2

Power LED

- This Indicator lights up green when the display operates normally. If the display is in DPM (Energy Saving) mode, this indicator color changes to amber.

3

MENU Button

- Use this button to show/hide the OSD (On Screen Display) menu screen.

4

OSD Select Adjust Button

- Use the button to select an icon or adjust the setting in the OSD screen.



- Use this button to directly control brightness and contrast of the PC signal (DSUB/DVI).

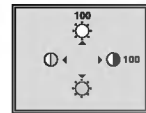

- Adjust the volume.



37

5 Name of the Buttons in the Screen Adjustment Unit

5 AUTO/SELECT Button

[For DSUB signal]

- Select the icon to adjust on the OSD screen.
- If you press the [AUTO/SELECT] button, automatic screen adjustment will be started.

AUTO IN PROGRESS

[Other signals than DSUB]

- The current signal and mode information will be displayed.

6 SOURCE Button

SOURCE → ▼▲ → **AUTO/SELECT**

- Select the input signal

DVI DIGITAL	DVI digital signal
DSUB ANALOG	15-pin D-Sub analog signal
VIDEO1(CVBS)	Composite video
VIDEO2(S-Video)	S-Video
DVD(Y, Cb, Cr)	DVD
HDTV(Y, Pb, Pr)	HD television

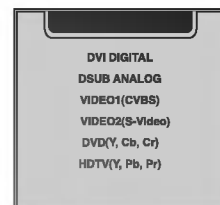

7

- The unit that receives the signal from the remote controller.

8

Main Power Switch

- Use this button to turn on/off the monitor.

OSD Lock/Unlock Button

Menu button + ►

- Use this button to lock/unlock OSD screen adjustment.
(Activated when pressed together longer than 5 seconds.)





CONTROLS LOCKED

- OSD is locked





CONTROLS UNLOCKED

- OSD is unlocked.

● OSD Menu – When Connected to Your PC

Icon	Function Description
 Adjustment	Adjusts screen brightness, contrast and color that you prefer.
 Tracking	Adjusts position of the screen, clock or phase.
 Audio	Adjusts the audio function.
 Setup	Adjusts the screen status according to the circumstances.
 PIP/POP/PBP	Adjusts PIP/POP/PBP mode function.

● OSD Menu – When Watching Video/DVD/HDTV

Icon	Function Description
 Video	Adjusts the screen video.
 Audio	Adjusts the audio function.
 Setup	Adjusts the screen status according to the circumstances.
 PIP/POP/PBP	Adjusts PIP/POP/PBP mode function.



Note

OSD(On Screen Display)

The OSD function enables you to adjust the screen status conveniently since it provides graphical presentation.



● How to adjust the OSD (On Screen Display) screen.

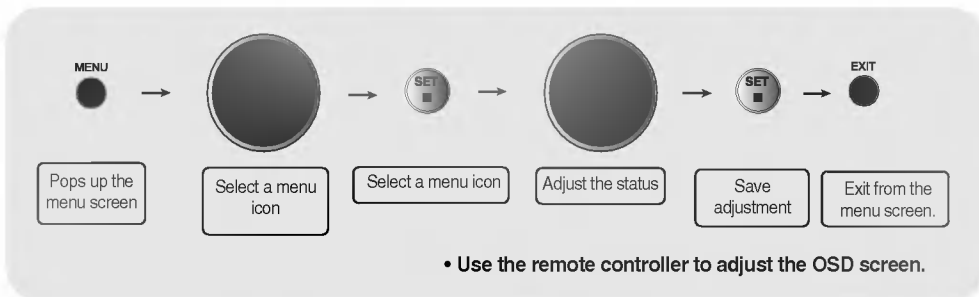

Press the **MENU** Button, then the main menu of the OSD appears.

To access a control, use the ▼▲ Buttons.

When the icon you want becomes highlighted, press the **SET** Button.

Use the ▼▲◀▶ Buttons to adjust the item to the desired level.

Accept the changes by pressing the **SET** Button.

Exit the OSD by Pressing the **EXIT** Button.

● How to adjust the screen automatically.

You need to adjust the screen display when connecting the monitor to a new computer or changing the mode. Refer to the following section to set an optimal monitor screen.

AUTO IN PROGRESS

Press the **AUTO/SELECT** button (**AUTO** button in a remote controller) in the PC analog signal. Then, an optimal screen status will be selected that fits into the current mode.

If adjustment is not satisfactory, you need to adjust screen position, clock and phase in the OSD menu.





Adjusting Screen Color



CONTRAST To adjust the contrast of the screen.

BRIGHTNESS To adjust the brightness of the screen.

COLOR Adjusting screen color. Press the ► button to display the submenu for COLOR.

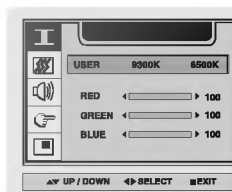

USER **9300K/6500K**
Selecting a factory setting color set.
• 9300K: Slightly bluish white.
• 6500K: Slightly reddish white.

RED
GREEN Set your own color levels.
BLUE



Adjusting Screen CLOCK/PHASE and Position

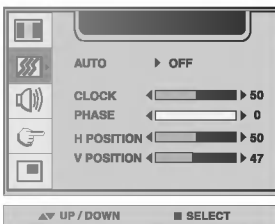

AUTO This function is suitable for analog signal input only. This button is for the automatic adjustment of the screen position, clock and phase.

CLOCK To minimize any vertical bars or stripes visible on the screen background. The horizontal screen size will also change.

PHASE To adjust the focus of the display. This item allows you to remove any horizontal noise and clear or sharpen the image of characters.

H POSITION To move image left or right.

V POSITION To move image up or down.



Note When connected to your computer and the digital input signal (DVI-DIGITAL), only ADJUSTMENT, AUDIO, SETUP and PIP/POP/PBP menu are enabled. Other menu items will be automatically adjusted.





Adjusting the audio function

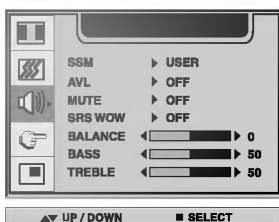

- SSM** The best sound tone quality will be selected automatically depending on the video type that you're currently watching.
- **USER** : Select this option to use the user-defined audio settings.
 - **FLAT** : The most commanding and natural audio.
 - **MOVIE** : Select this option to enjoy sublime sound.
 - **MUSIC** : Select this option to enjoy the original sound when listening to the music.
 - **SPORTS** : Select this option to watch sports broadcasting.
- AVL** To adjust uneven sound volumes across all channels or signals automatically to the most appropriate level. To use this feature, select ON.
- MUTE** Used to select mute ON(means sound off) and mute OFF(means sound on).
- SRS WOW** Set the SRS WOW menu on.
The SRS WOW function plays back the mono or stereo sound input with the dynamic surround effects. It will provide rich and profound sound tone. If you set the SRS WOW on, bass/treble will be automatically adjusted.
- BALANCE** Use this function to balance sound from the left and right speakers.
- BASS** To raises or lowers Bass level.
- TREBLE** To raises or lowers Treble level.



Note

When connected to your computer and the 'SSM' setting in the audio menu is one of FLAT, MOVIE, MUSIC or SPORTS, the available menus are AVL, MUTE and BALANCE.





Selecting the options

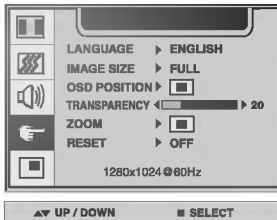

LANGUAGE To choose the language in which the control names are displayed.

IMAGE SIZE To select the image size of the screen. (FULL/1:1)

OSD POSITION To adjust position of the OSD window on the screen. Press the ► button to display the submenu for OSD POSITION.

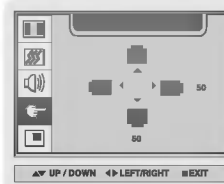

◀ Left
▶ Right Moving the OSD screen position horizontally.

▲ Up
▼ Down Moving the OSD screen position vertically.

TRANSPARENCY To adjust the transparency of the OSD menu screen.

ZOOM Use this function to zoom in the screen. When you turn the monitor off and on again, the default screen size will be restored. Press the ► button to display the submenu for OSD POSITION.

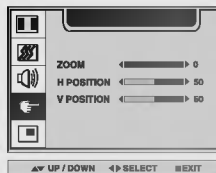

* If the zooming value is set to '0', vertical and horizontal positioning cannot be adjusted.

RESET Use this function to reset the monitor to the factory default. However, language selection will not be initialized.



Note

When connected to your computer, the Zoom menu will be disabled if the screen size is 1:1 or PIP/POP/PBP is in use.

Adjusting PIP/POP/PBP Mode (Multiple Screen) Functions

To adjust the PIP(PICTURE IN PICTURE) of the screen

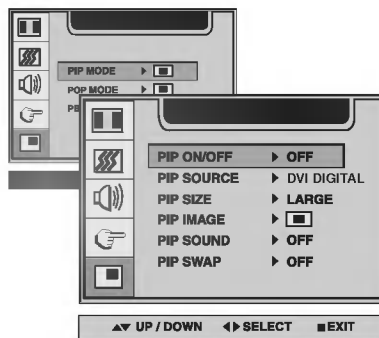

PIP ON/OFF After selecting ON in the PIP ON/OFF menu, the following menu items can be adjusted.



PIP SOURCE To select an input signal for PIP.

PIP SIZE To adjust the size of the PIP screen. (SMALL/LARGE)

PIP IMAGE To adjust the image of the PIP screen; Press the ► button to display the submenu for PIP IMAGE. Use the ◀ ► buttons to adjust the item to the desired level. The items of the sub-menu may vary depending on the type of the source.

	■ PIP POSITION	Adjust the PIP screen position.
	■ PIP CONTRAST	Adjust PIP screen contrast.
	■ PIP BRIGHTNESS	Adjust PIP screen brightness.
	■ PIP SHARPNESS	Adjust PIP screen sharpness.
	■ PIP COLOR	Adjust the PIP screen color.

* The sub-menu can differ according to the type of the input signal.

PIP SOUND To turn the PIP sound on/off.

PIP SWAP To switch the main-screen and sub-screen in PIP mode.



Adjusting PIP/POP/PBP Mode (Multiple Screen) Functions

To adjust the POP(PICTURE OUT PICTURE) of the screen

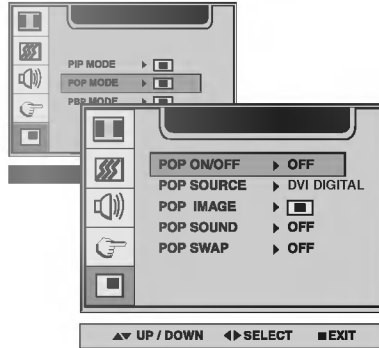

POP ON/OFF After selecting ON in the POP ON/OFF menu, the following menu items can be adjusted.



POP SOURCE To select an input signal for POP.

POP IMAGE To adjust the image of the POP screen; Press the ► button to display the submenu for POP IMAGE. Use the ◀ ► buttons to adjust the item to the desired level.

	■ POP CONTRAST	Adjust POP screen contrast.
	■ POP BRIGHTNESS	Adjust POP screen brightness.
	■ POP SHARPNESS	Adjust POP screen sharpness.
	■ POP COLOR	Adjust the POP screen color.

* The sub-menu can differ according to the type of the input signal.

POP SOUND To turn the POP sound on/off.

POP SWAP To switch the main-screen and sub-screen in POP mode.



Note

The 'POP IMAGE' menu will be disabled if the POP screen input is a PC signal.

Adjusting PIP/POP/PBP Mode (Multiple Screen) Functions

To adjust the PBP(PICTURE BY PICTURE) of the screen

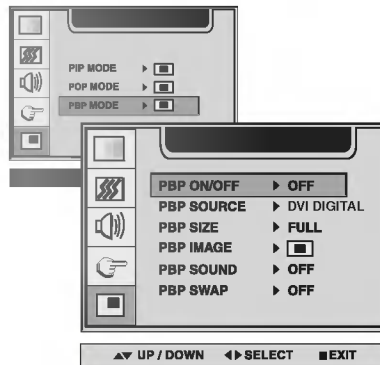

PBP ON/OFF After selecting ON in the PBP ON/OFF menu, the following menu items can be adjusted.



PBP SOURCE To select an input signal for PBP.

PBP SIZE To adjust the size of the PBP screen. (FULL/4:3)

PBP IMAGE To adjust the image of the PBP screen; Press the ► button to display the submenu for PBP IMAGE. Use the ◀ ► buttons to adjust the item to the desired level. The items of the sub-menu may vary depending on the type of the source.

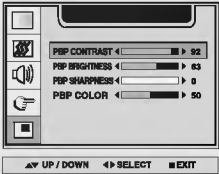

- **PBP CONTRAST** Adjust PBP screen contrast.
- **PBP BRIGHTNESS** Adjust PBP screen brightness.
- **PBP SHARPNESS** Adjust PBP screen sharpness.
- **PBP COLOR** Adjust the PBP screen color.

* The sub-menu can differ according to the type of the input signal.

PBP SOUND To turn the PBP sound on/off.

PBP SWAP To switch the main-screen and sub-screen in PBP mode.



Note

The 'PBP IMAGE' menu will be disabled if the PBP screen input is a PC signal.



Adjusting Screen Image

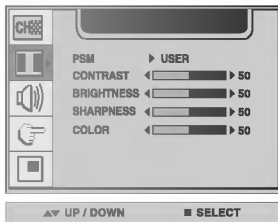

PSM

The PSM function automatically adjusts the screen image quality depending on the AV usage environment.

- **USER** : Select this option to use the user-defined settings.
- **GAME** : Select this option to enjoy dynamic image when playing a game.
- **STANDARD** : The most general and natural screen display status.
- **DYNAMIC** : Select this option to display with a sharp image.
- **MILD** : Select this option to display with a mild image.

CONTRAST To adjust the contrast of the screen.

BRIGHTNESS To adjust the brightness of the screen.

SHARPNESS To adjust the clearness of the screen.

COLOR To adjust the color to desired level.



Note

If the 'PSM' setting in the Video menu is set to GAME, STANDARD, DYNAMIC or MILD the subsequent menus will be automatically set.





Adjusting the audio function



SSM

The best sound tone quality will be selected automatically depending on the video type that you're currently watching.

- **USER** : Select this option to use the user-defined audio settings.
- **FLAT** : The most commanding and natural audio.
- **MOVIE** : Select this option to enjoy sublime sound.
- **MUSIC** : Select this option to enjoy the original sound when listening to the music.
- **SPORTS** : Select this option to watch sports broadcasting.

AVL

To adjust uneven sound volumes across all channels or signals automatically to the most appropriate level. To use this feature, select ON.

SRS WOW

Set the SRS WOW menu on. The SRS WOW function plays back the mono or stereo sound input with the dynamic surround effects. It will provide rich and profound sound tone. If you set the SRS WOW on, bass/treble will be automatically adjusted.

SOUND

To select the audio mode.
: MONO/STEREO

MUTE

Used to select mute ON(means sound off) and mute OFF(means sound on).

BALANCE

Use this function to balance sound from the left and right speakers.

BASS

To raises or lowers Bass level.

TREBLE

To raises or lowers Treble level.



Note

If the 'SSM' setting in the audio menu is one of FLAT, MOVIE, MUSIC or SPORTS, the available menus are AVL, SOUND, MUTE and BALANCE. Other menu items will be automatically adjusted.



Selecting the options

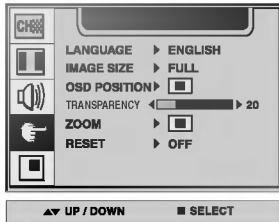

LANGUAGE To choose the language in which the control names are displayed.

IMAGE SIZE To select the image size of the screen.
(FULL/4:3/SPECTACLE/1:1)

OSD POSITION To adjust position of the OSD window on the screen.
Press the ► button to display the submenu for OSD POSITION.

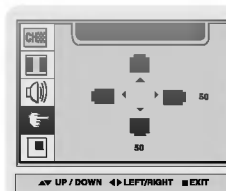

◀ Left
▶ Right Moving the OSD screen position horizontally.

▲ Up
▼ Down Moving the OSD screen position vertically.

TRANSPARENCY To adjust the transparency of the OSD menu screen.

ZOOM Use this function to zoom in the screen. When you turn the monitor off and on again, the default screen size will be restored.
Press the ► button to display the submenu for OSD POSITION.

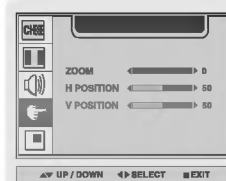

* If the zooming value is set to '0', vertical and horizontal positioning cannot be adjusted.

RESET Use this function to reset the monitor to the factory default. However, language selection will not be initialized.



Note

The 'ZOOM' menu will be disabled when the screen size is 4:3, spectacle or 1:1, or PIP/POP/PBP is activated.

Adjusting PIP/POP/PBP Mode (Multiple Screen) Functions

To adjust the PIP(PICTURE IN PICTURE) of the screen

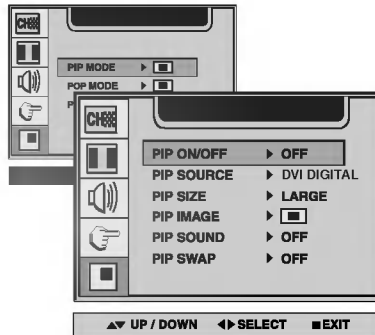

PIP ON/OFF After selecting ON in the PIP ON/OFF menu, the following menu items can be adjusted.



PIP SOURCE To select an input signal for PIP.

PIP SIZE To adjust the size of the PIP screen. (SMALL/LARGE)

PIP IMAGE To adjust the image of the PIP screen; Press the ► button to display the submenu for PIP IMAGE. Use the ◀ ► buttons to adjust the item to the desired level. The items of the sub-menu may vary depending on the type of the source.

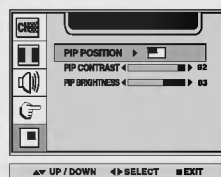

- PIP POSITION Adjust the PIP screen position.
- PIP CONTRAST Adjust PIP screen contrast.
- PIP BRIGHTNESS Adjust PIP screen brightness.

* The sub-menu can differ according to the type of the input signal.

PIP SOUND To turn the PIP sound on/off.

PIP SWAP To switch the main-screen and sub-screen in PIP mode.



Adjusting PIP/POP/PBP Mode (Multiple Screen) Functions

To adjust the POP(PICTURE OUT PICTURE) of the screen

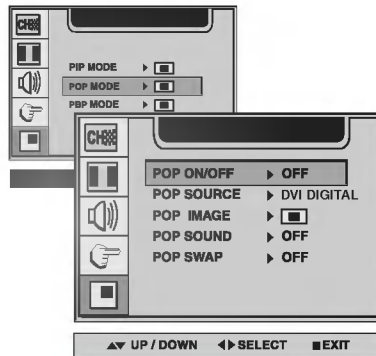

POP ON/OFF After selecting ON in the POP ON/OFF menu, the following menu items can be adjusted.



POP SOURCE To select an input signal for POP.

POP IMAGE To adjust the image of the POP screen; Press the ► button to display the submenu for POP IMAGE. Use the ◀ ► buttons to adjust the item to the desired level.

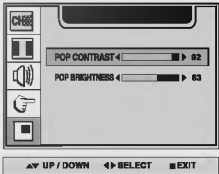

- **POP CONTRAST** Adjust POP screen contrast.
- **POP BRIGHTNESS** Adjust POP screen brightness.

* The sub-menu can differ according to the type of the input signal.

POP SOUND To turn the POP sound on/off.

POP SWAP To switch the main-screen and sub-screen in POP mode.



The 'POP IMAGE' menu will be disabled if the POP screen input is video.

Adjusting PIP/POP/PBP Mode (Multiple Screen) Functions

To adjust the PBP(PICTURE BY PICTURE) of the screen

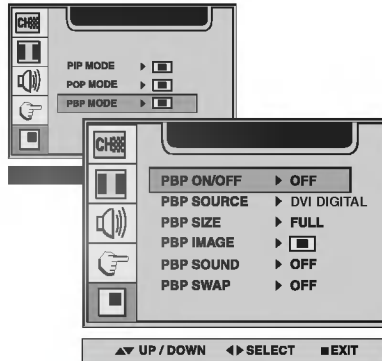

PBP ON/OFF After selecting ON in the PBP ON/OFF menu, the following menu items can be adjusted.



PBP SOURCE To select an input signal for PBP.

PBP SIZE To adjust the size of the PBP screen. (FULL/4:3)

PBP IMAGE To adjust the image of the PBP screen; Press the ► button to display the submenu for PBP IMAGE. Use the ◀ ► buttons to adjust the item to the desired level. The items of the sub-menu may vary depending on the type of the source.

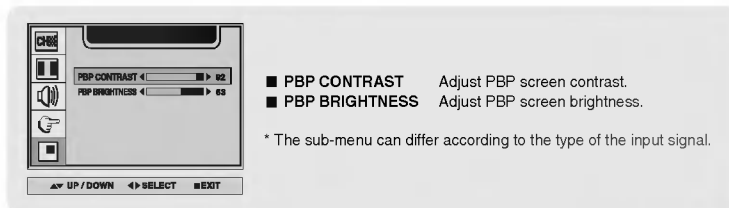

PBP SOUND To turn the PBP sound on/off.

PBP SWAP To switch the main-screen and sub-screen in PBP mode.



Note

The 'PBP IMAGE' menu will be disabled if the PBP screen input is video.

* The RS-232C protocol is used for communication between the PC and monitor. You can turn the monitor on/off, select an input source or adjust the OSD menu from your PC.

Connecting the cable

- Connect the PC RS-232C (serial connector) terminal to the RS-232C terminal at the rear side of the monitor.
- The cable for RS-232C terminal connection is not an accessory included in the product. Please purchase the cable.

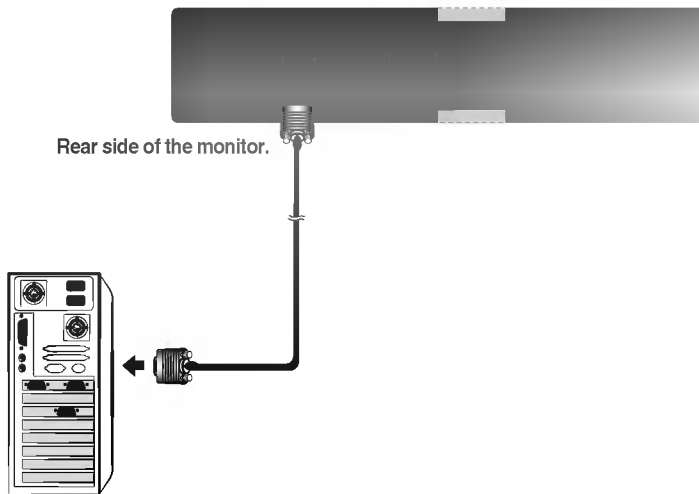

Communication Parameter

- ▶ Baud Rate : 115200bps
- ▶ Data Length : 8bits
- ▶ Parity Bit : NONE
- ▶ Stop Bit : 1bit
- ▶ Flow Control : NONE

● Commands Related with User Control

Function		Command (HEX)	Parameter#3 (HEX)	Parameter#4 (HEX)
POWER	ON	01h	01h	-
	OFF		00h	-
MAIN INPUT	DVI DIGITAL	0Fh	00h	-
	DSUB ANALOG		01h	-
	VIDEO1(CVBS)		02h	-
	VIDEO2(S-Video)		03h	-
	DVD		04h	-
	HDTV		05h	-
SUB INPUT	DVI DIGITAL	10h	00h	-
	DSUB ANALOG		01h	-
	VIDEO1(CVBS)		02h	-
	VIDEO2(S-Video)		03h	-
	DVD		04h	-
	HDTV		05h	-
CONTRAST		03h	00h ~64h	-
BRIGHTNESS		04h	00h ~64h	-
SHARPENESS		05h	00h ~64h	-
COLOR		06h	00h ~64h	-
9300K		08h	-	-
6500K		09h	-	-
USER		0Ah	-	-
USER	RED	0Bh	00h	00h ~ FFh
	GREEN		01h	00h ~ FFh
	BLUE		02h	00h ~ FFh

Adjust Command/Protocol

Parameter #1 (8 Byte length) : Device selection

0	1	2	3	4	5	6	7
Length : 08h	11h	Param ID : 01h	00h	00h	00h	Device ID (00h~63h)	Check sum

Parameter #2 (8 Byte length) : Read/Write selection

0	1	2	3	4	5	6	7
Length : 08h	11h	Param ID : 02h	00h	00h	00h	Write : 01h	Check sum

Parameter #3 (8 Byte length) : Value

0	1	2	3	4	5	6	7
Length : 08h	11h	Param ID : 03h	Parameter value (4 Byte : DWORD)				Check sum
			High 2Byte		Low 2Byte		

Parameter #4 (8 Byte length) : Value

Function command (4 Byte length)

0	1	2	3
Length = 04h	AAh	Function Command	Check sum

● **Is the monitor power cord connected?**

● **Does the power LED is turned on?**

● **Power is on, power LED is green but the screen appears extremely dark.**

● **Does the power LED look yellow?**

● **Does the 'OUT OF RANGE' message appear?**

● **Does the 'CHECK SIGNAL CABLE' message appear?**

• See if the power cord is properly connected to the outlet.

• See if the power switch is turned on.

• Adjust brightness (☼) and contrast (●) again.

• If the monitor is in power saving mode, move the mouse or press any key.

• The signal from the PC (video card) is out of the vertical or horizontal frequency range of the monitor. Adjust the frequency range by referring to the Specifications in this manual.

*** Maximum resolution**

D-Sub : 1280x1024 @60Hz

DVI-D : 1280x1024 @60Hz

• The signal cable between PC and monitor is not connected. Check the signal cable.

• Press the 'SOURCE' menu in the remote controller to check the input signal.

● **Did you install the driver?**

• Install the monitor driver, which is provided with the monitor, or download it from the web site. (<http://www.lge.com>)

• See if the plug&play function is supported by referring to the video card user manual.

● **The 'CONTROLS LOCKED' message appears when pressing the Menu button.**

• The control locking function prevents unintentional OSD setting change due to careless usage. To unlock the controls, simultaneously press the Menu button and ► button for 5 seconds. (You cannot set this function using the remote controller buttons. You can set this function in the monitor only.)



Note

* **Vertical frequency:** To enable the user to watch the monitor display, screen image should be changed tens of times every second like a fluorescent lamp. The vertical frequency or refresh rate is the times of image display per second. The unit is Hz.

* **Horizontal frequency:** The horizontal interval is the time to display one vertical line. When 1 is divided by the horizontal interval, the number of horizontal lines displayed every second can be tabulated as the horizontal frequency. The unit is kHz.

The screen image looks abnormal.

- **Is the screen position wrong?**
 - D-Sub analog signal – Press the “AUTO” button in the remote controller to automatically select the optimal screen status that fits into the current mode. If adjustment is not satisfactory, use the Position OSD menu.
 - See if the video card resolution and frequency are supported by the monitor. If the frequency is out of range, set to the recommended resolution in the Control Panel – Display – Setting menu.
- **Do thin lines appear on the background screen?**
 - D-Sub analog signal – Press the “AUTO” button in the remote controller to automatically select an optimal screen status that fits into the current mode. If adjustment is not satisfactory, use the Clock OSD menu.
- **Horizontal noise appears or the characters look blurred.**
 - D-Sub analog signal – Press the “AUTO” button in the remote controller to automatically select an optimal screen status that fits into the current mode. If adjustment is not satisfactory, use the Phase OSD menu.
- **Unable to adjust the horizontal/vertical position in the Zoom menu.**
 - See if the Zoom value is set to 0. If it is, you cannot adjust the H/V Position value.
- **Screen size is automatically adjusted when connected to the PC.**
 - If the screen size is not full when connected to the PC, execute the PIP/POP/PBP to change to full screen mode.
- **Brightness differs in the main and sub screen when connected to the PC.**
 - You cannot adjust brightness and tint in the PIP/POP/PBP Screen menu for the sub-screen among PIP/POP/PBP menus. Therefore, brightness can be different for the sub-screen.

After-image appears on the monitor.

- **After-image appears when the monitor is turned off.**
 - If you use a fixed image for a long time, the pixels may be damaged quickly. Use the screensaver function.

Troubleshooting

The audio function does not work.

- No sound?
 - See if the audio cable is connected properly.
 - Adjust the volume.
 - See if the sound is set properly.
- No sound is available when the PIP/POP/PBP mode is engaged.
 - See if the Sound is set to On in the PIP/POP/PBP menu.
- Sound is too dull.
 - Select the appropriate treble sound.
 - Select the appropriate bass sound.
- Sound is too low.
 - Adjust the volume.

The screen size function in the OSD menu does not work.

- The screen size function in the OSD menu does not work.
 - See if the PIP/POP/PBP function is in use. If the PIP/POP/PBP function is in use, the screen size function may not work.

Screen color is abnormal.

- Screen has poor color resolution (16 colors).
 - Set the number of colors to more than 24 bits (true color)
Select Control Panel – Display – Settings – Color Table menu in Windows.
- Screen color is unstable or mono-colored.
 - Check the connection status of the signal cable.
Or, re-insert the PC video card.
- Do black spots appear on the screen?
 - Several pixels (red, green, white or black color) may appear on the screen, which can be attributable to the unique characteristics of the LCD panel. It is not a malfunction of the LCD.

The product specifications can change without prior notice for product improvement.

LCD Panel	Screen Type	30 inches (75.0062cm) TFT (Thin Film Transistor) LCD (Liquid Crystal Display) Panel Visible diagonal size: 75.0062cm
	Pixel Pitch	0.5025mm
Video Signal	Max. Resolution	D-SUB : 1280 X 1024 @60Hz DVI-D : 1280 X 1024 @60Hz
	Recommended Resolution	D-SUB : WXGA 1280 X 768 @60Hz DVI-D : WXGA 1280 X 768 @60Hz
	Horizontal Frequency	D-SUB : 30 - 66 kHz DVI-D : 30 - 66 kHz
	Vertical Frequency	56 - 85 Hz
	Synchronization Type	Separate/Composite/SOG (Sync On Green)/Digital
Input Connector		15-pin D-Sub type, DVI-D (digital), S-Video, Composite video, HDTV, DVD
Power	Rated Voltage	AC 100-240V~ 50/60Hz 1.8A
	Power Consumption	Normal operation: 160W Power saving preparation state: ≤ 5W Power saving state: ≤ 5W Power switch on: ≤ 5W Power cut-off, switch off: ≤ 1W
Dimension/Weight	Size (WxLxH)	733.8mm x 538.0 mm x 107.0mm
	Weight (excl. package)	17.0 kg
Environmental Conditions	Operational Condition	Temperature: 10°C ~ 35°C , Humidity: 10% ~ 80%
	Storage Condition	Temperature: -20°C ~ 60°C , Humidity: 5% ~ 95%



● PC Mode – Preset Mode

1	VGA	640 x 350	31.469	70	8	VESA	800 x 600	53.674	85
2	VGA	720 x 400	31.468	70	9	MAC	832 x 624	49.725	75
3	VGA	640 x 480	31.469	60	10	VESA	1024 x 768	48.363	60
4	VESA	640 x 480	37.500	75	11	VESA	1024 x 768	60.123	75
5	VESA	640 x 480	43.269	85	12	VESA	1280 x 1024	63.981	60
6	VESA	800 x 600	37.879	60	13	VESA	1280 x 768	47.7	60
7	VESA	800 x 600	46.875	75					

● Power LED

Normal Operation	Green
Pre-power Saving State	Amber
Power Saving State	Amber
Power Switch Off	-
Power Cut-off Switch Off	-

VESA wall mounting

Connected to another object (stand type and wall-mounted type). This monitor accepts a VESA-compliant mounting interface pad.-optional)
For further information, refer to the VESA Wall Mounting Instruction Guide.

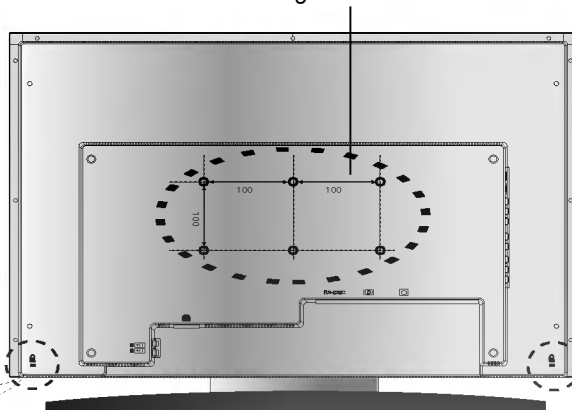

Locking Device

Use this locking cable (optional) to prevent theft.



● DVI-D

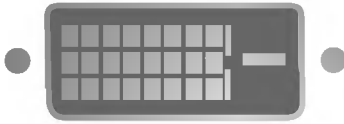

1	T. M. D. S. Data 2-
2	T. M. D. S. Data 2+
3	T. M. D. S. Data 2/4 Shield
4	T. M. D. S. Data 4-
5	T. M. D. S. Data 4+
6	DDC Clock
7	DDC Data
8	Analog Vertical Synchronization
9	T. M. D. S. Data 1-
10	T. M. D. S. Data 1+
11	T. M. D. S. Data 1/3 Shield
12	T. M. D. S. Data 3-
13	T. M. D. S. Data 3+
14	+5V Power
15	Grounding (return for +5V, horizontal sync and vertical sync)
16	Hot Plug Detect
17	T. M. D. S. Data 0-
18	T. M. D. S. Data 0+
19	T. M. D. S. Data 0/5 Shield
20	T. M. D. S. Data 5-
21	T. M. D. S. Data 5+
22	T. M. D. S. Clock Shield
23	T. M. D. S. Clock+
24	T. M. D. S. Clock

T.M.D.S. (Transition Minimized Differential Signaling)

Digitally yours ■■■■■.....

