



PLASMA MONITOR OWNER'S MANUAL

**MODELS: MP-50PZ44/44H/45M/45V
MP-50PZ44A/44HA/45MA/45VA
MP-50PZ44B/44HB/45MB/45VB
MP-50PZ44K/44HK/45MK/45VK
MP-50PZ44R/44HR/45MR/45VR
MP-50PZ44S/44HS/45MS/45VS
MP-50PZ90/90H/91M/91V
MP-50PZ90A/90HA/91MA/91VA
MP-50PZ90B/90HB/91MB/91VB
MP-50PZ90K/90HK/91MK/91VK
MP-50PZ90R/90HR/91MR/91VR
MP-50PZ90S/90HS/91MS/91VS**

Please read this owner's manual thoroughly before operating the Monitor.

Retain it for future reference.

Record model number and serial number of the Monitor.

See the label attached on the back of the Monitor and relate this information to your dealer if you ever require service.

Model Number :

Serial Number :



Safety Instructions

* Safety instructions have two kinds of information, and each meaning of it is as below.

 **WARNING** The violation of this instruction may cause serious injuries and even death.

 **NOTES** The violation of this instruction may cause light injuries or damage of the product.

 Take care of danger that may happen under specific condition.

WARNING

- 1. Do not place the Monitor in direct sunlight or near heat sources such as heat registers, stove and so on.**
This may cause a fire.
- 2. Do not use the Monitor in damp place such as a bathroom or any place where it is likely to get wet.**
This may cause a fire or could give an electric shock.
- 3. Bend antenna cable between inside and outside building to prevent rain from flowing in.**
This may cause water damaged inside the Monitor and could give an electric shock.
- 4. Earth wire should be connected.**
 - If the earth wire is not connected, there is possible a danger of electric shock caused by the current leakage.
 - If grounding methods are not possible, a separate circuit breaker should be employed and installed by a qualified electrician.
 - Do not connect ground to telephone wires, lightning rods or gas pipe.
- 6. Do not insert any object into the exhaust vent.**
This may cause a fire or could give an electric shock.
- 7. Do not place heavy objects on the Monitor.**
This may cause serious injury to a child or adult.
- 8. Do not use water the Monitor while cleaning.**
This may cause damaged the Monitor or could give an electric shock.
- 9. In case of smoke or strange smell from the Monitor, switch it off ,unplug it from the wall outlet and contact your dealer or service center.**
This may cause a fire or could give an electric shock.
- 10. Do not attempt to service the Monitor yourself. Contact your dealer or service center.**
This may cause damaged the Monitor or could give an electric shock.
- 11. During a lightning thunder, unplug the Monitor from the wall outlet and don't touch an antenna cable.**
This may cause damaged the Monitor or could give an electric shock.

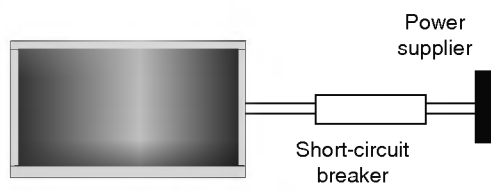

- 5. Do not placing anything containing liquid on top of the Monitor.**
This may cause a fire or could give an electric shock.

NOTE

1. **Never touch the power plug with a wet hand.**

This may cause an electric shock.

2. **Disconnect from the mains and remove all connections before moving.**

3. **Do not place the Monitor in a built-in installation such as a bookcase or rack.**

Ventilation required.

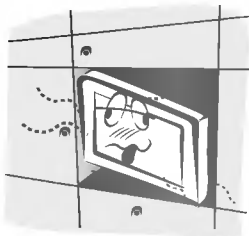

4. **When installing the Monitor on a table, be careful not to place the edge of its stand.**

This may cause the Monitor to fall, causing serious injury to a child or adult, and serious damage to the Monitor.



5. **Do not place an outside antenna in the vicinity of overhead power lines or other electric light or power circuits.**

This may cause an electric shock.

6. **There should be enough distance between an outside antenna and power lines to keep the former from touching the latter even when the antenna falls.**

This may cause an electric shock.

7. **Do not pull the cord but the plug when unplugging.**

This may cause a fire.

8. **Ensure the power cord doesn't trail across any hot objects like a heater.**

This may cause a fire or an electric shock.

9. **Do not plug when the power cord or the plug is damaged or the connecting part of the power outlet is loose.**

This may cause a fire or an electric shock.

10. **Dispose of used batteries carefully to protect a child from eating them.**

In case that it eats them, take it to see a doctor immediately.

11. **When moving the Monitor assembled with speakers do not carry holding the speakers.**

This may cause the Monitor to fall, causing serious injury to a child or adult, and serious damage to the Monitor.

12. **Unplug this product from the wall outlet before cleaning. Do not use liquid cleaners or aerosol cleaners.**

This may cause damaged the Monitor or could give an electric shock.

13. **Contact the service center once a year to clean the internal part of the Monitor.**

Accumulated dust can cause mechanical failure.

14. **The distance between eyes and the screen should be about 5 ~ 7 times as long as diagonal length of the screen.**

If not, eyes will strain.

15. **Unplug the Monitor from the wall outlet when it is left unattended and unused for long periods of time.**

Accumulated dust may cause a fire or an electric shock from deterioration or electric leakage.

16. **Only use the specified batteries.**

This may cause damaged the Monitor or could give an electric shock.

Contents

Safety Instructions	2~3
Introduction	
Controls and Connection Options	6
Remote Control Key Functions	7
Installation	
Installation Instruction	8~10
External Equipment Connections	11~14
VCR Setup	11
Cable TV Setup	11
External A/V Source Setup	12
DVD Setup	12
DTV Setup	12
PC Setup	13~14
Operation	
Turning on the Monitor	15
Menu Language Selection	15
Video Menu Options	
APC (Auto Picture Control)	16
Manual Picture Control	16
Auto Color Temperature Control	16
Manual Color Temperature Control	16
Audio Menu Options	
DASP (Digital Auto Sound Processing)	17
Manual Sound Control	17
AVL (Auto Volume Leveler)	17
Time Menu Options	
Clock Setup	18
On/Off Timer Setup	18
Auto Off	18
Sleep Timer	18
Special Menu Options	
Key Lock	19
ISM Method	19
Low power	19
Menu Rotation for Vertical Viewing	19
Screen Menu Options	
Auto Adjustment	20
Setting Picture Format	20
Picture Size Zoom	20
Split Zoom	21
Screen Position	21
Manual Configure	21
Screen Adjustments	22
Initializing	22
Selecting Wide VGA/XGA mode	22
Luminance Noise Reduction	22
PIP (Picture-in-Picture) Feature	
Watching PIP	23
PIP Size	23
PIP Aspect Ratio	23
Swapping PIP	23
Moving PIP	23
Selecting an Input Signal Source for PIP	23
Twin Picture Setup Options	
Watching Twin Picture	24
Sub Picture Size Adjustment	24
Swapping the Twin Picture	24
Selecting a Source for the Twin Picture	24
External Control Device Setup	25~30
IR Code	31~32
Troubleshooting Checklist	33
Specifications	34

Introduction

What is a Plasma Display Panel (PDP)?

If voltage is applied to gas within glass panels, ultraviolet rays are produced and fused with a fluorescent substance. At that instant, light is emitted. A Plasma Display is a next generation flat Display using this phenomenon.

160° - Wide angle range of vision

Your flat panel plasma screen offers an exceptionally broad viewing angle -- over 160 degrees. This means that the display is clear and visible to viewers anywhere in the room.

Wide Screen

The screen of the Plasma Display is 50" so wide that your viewing experience is as if you are in a theater.

Multimedia

Connect your plasma display to a PC and you can use it for conferencing, games, and internet browsing. The Picture-in-Picture feature allows you to view your PC and video images simultaneously.

Versatile

The light weight and thin size makes it easy to install your plasma display in a variety of locations where conventional TVs would not fit.

The PDP Manufacturing Process: Why minute colored dots may be present on the PDP screen

The PDP (Plasma Display Panel) which is the display device of this product is composed of 0.9 to 2.2 million cells. A few cell defects will normally occur in the PDP manufacturing process. Several minute colored dots visible on the screen should be acceptable. This also occurs in other PDP manufacturers' products and the tiny dots appearing does not mean that this PDP is defective. Thus a few cell defects are not sufficient cause for the PDP to be exchanged or returned. Our production technology is designed to minimize cell defects during the manufacture and operation of this product.

Cooling Fan Noise

In the same way that a fan is used in a PC computer to keep the CPU (Central Processing Unit) cool, the PDP is equipped with cooling fans to cool the Monitor and improve its reliability. Therefore, a certain level of noise could occur while the fans are operating and cooling the PDP.

The fan noise doesn't have any negative effect on the PDP's efficiency or reliability. The noise from these fans is normal during the operation of this product. We hope you understand that a certain level of noise from the cooling fans is acceptable and is not sufficient cause for the PDP to be exchanged or returned.

WARNING

TO REDUCE THE RISK OF FIRE AND ELECTRIC SHOCK, DO NOT EXPOSE THIS PRODUCT TO RAIN OR MOISTURE.

Controls

- This is a simplified representation of front panel.
Here shown may be somewhat different from your monitor.

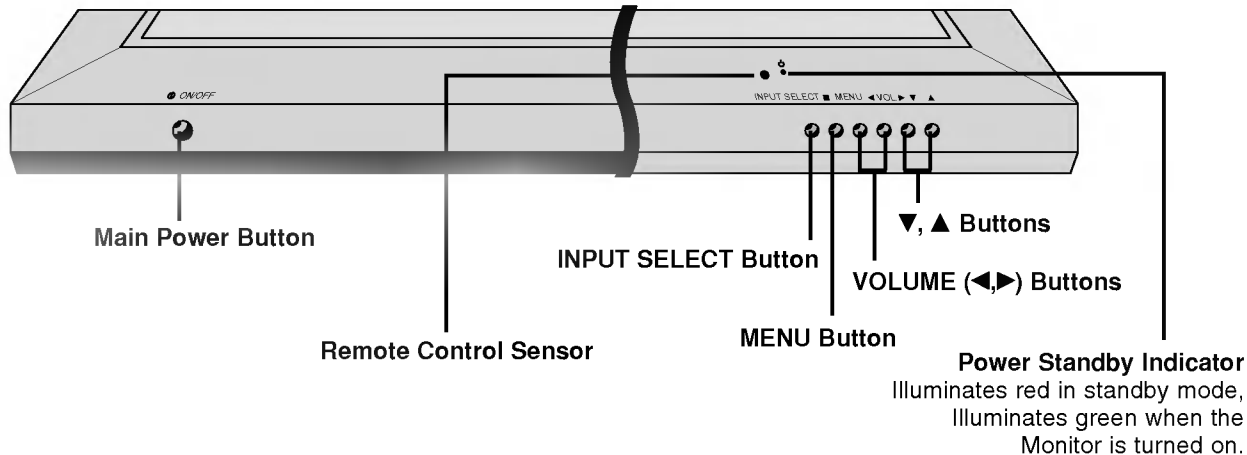

Connection Options

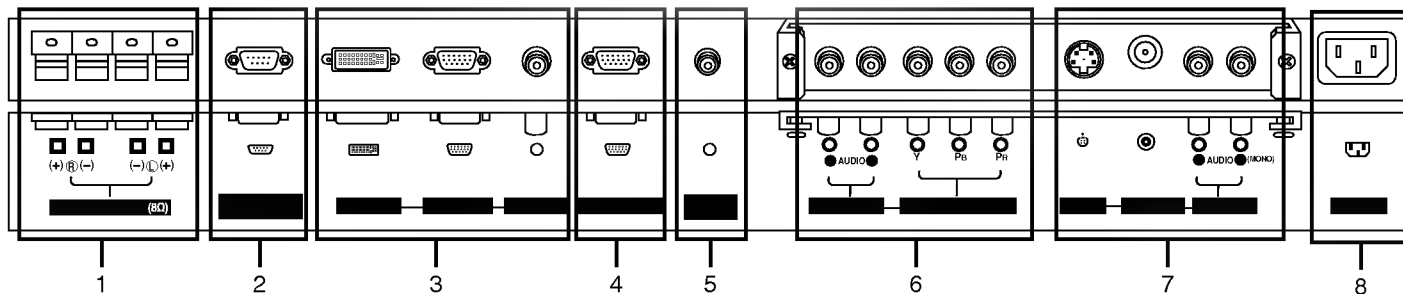

1. EXTERNAL SPEAKER OUTPUT (8 ohm)

Connect to optional external speaker(s).

* For further information, refer to 'Speaker & Speaker Stand' manual.

2. RS-232C INPUT (CONTROL/SERVICE) PORT

Connect to the RS-232C port on a PC.

3. DVI (Digital Visual Interface) INPUT/ RGB INPUT/AUDIO INPUT JACKS

Connect the monitor output connector from a PC to the appropriate input port.

4. RGB OUTPUT PORT

You can watch the RGB signal on another monitor, connect RGB OUTPUT to another monitor's PC input port.

5. REMOTE CONTROL

Connect your wired remote control to the remote control port on the Monitor.

6. COMPONENT INPUT/AUDIO INPUT JACKS

Connect a component video/audio device to these jacks.

7. S-VIDEO INPUTS

Connect S-Video out jack from an VCR to the S-VIDEO input jack.

AUDIO/VIDEO INPUT JACKS

Connect audio/video out from external equipment to these jacks.

8. POWER CORD SOCKET

This Monitor operates on an AC power. The voltage is indicated on the Specifications page. Never attempt to operate the Monitor on DC power.

Remote Control Key Functions

- When using the remote control, aim it at the remote control sensor on the monitor.
- Under certain conditions such as if the remote IR signal is interrupted, the remote control may not function. Press the key again as necessary.

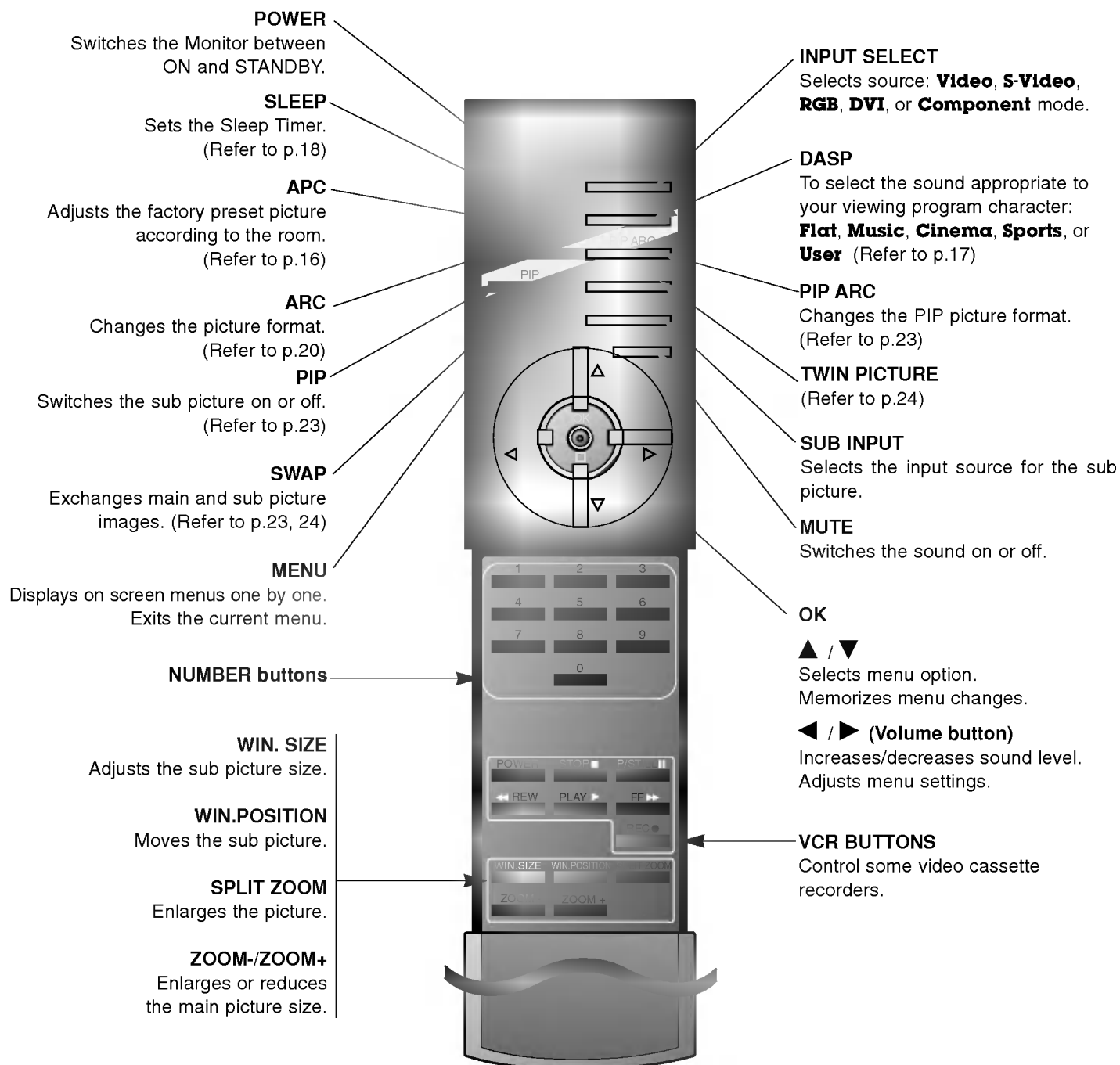

- Open the battery compartment cover on the back side and insert the batteries with correct polarity.
- Install two 1.5V batteries of AAA type. Don't mix used batteries with new batteries.

Installation

Ensure that the following accessories are included with your plasma display. If an accessory is missing, please contact the dealer where you purchased the product.

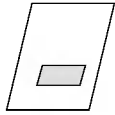

Owner's Manual

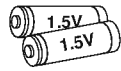

Batteries



BNC-RCA Adapter



Remote Control



D-sub 15 pin Cable



Power Cord



DVI-D Cable



- Optional extras can be changed or modified for quality improvement without any notification new optional extras can be added.
- Contract your dealer for buying these items.

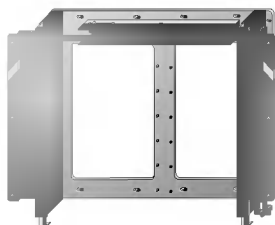

Tilt wall mounting bracket

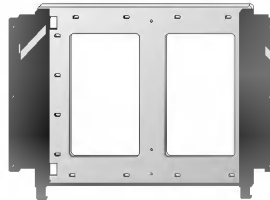

Wall mounting bracket

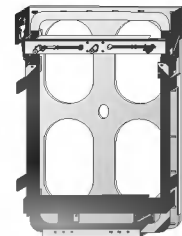

Vertical wall mounting bracket
(MP-50PZ45M/45V/91M/91V
series models only)

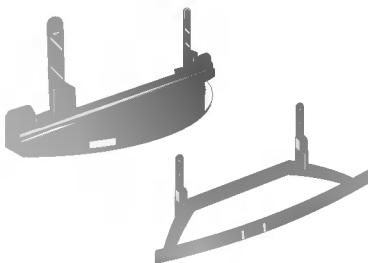

Desktop stand



Speakers

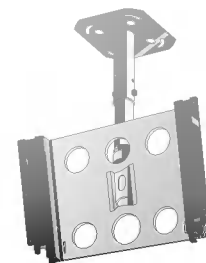

Ceiling mounting bracket



Desktop Speaker stand



Video cables



Audio cables

Installation Instructions

- The Monitor can be installed in various ways such as on a wall, or on a desktop etc.
- It is recommended that MP-50PZ44/45V/90/91V series models only be used at an altitude of less than 3281 feet (1000m) to get the best quality picture and sound.
- It is recommended that MP-50PZ44H/45M/90H/91M series models only be used at an altitude of less than 6561 feet (2000m) to get the best quality picture and sound.

GROUNDING

Ensure that you connect the grounding / earth wire to prevent possible electric shock. If grounding methods are not possible, have a qualified electrician install a separate circuit breaker. Do not try to ground the unit by connecting it to telephone wires, lightening rods, or gas pipes.

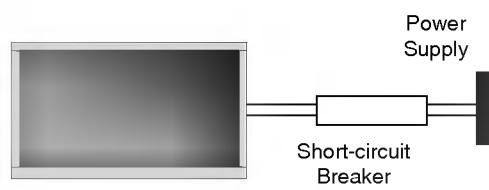

For proper ventilation, allow a clearance of 4" on each side and 1.18" from the wall. Detailed installation instructions are available from your dealer, see the optional Wall Mounting Bracket Installation and Setup Guide.

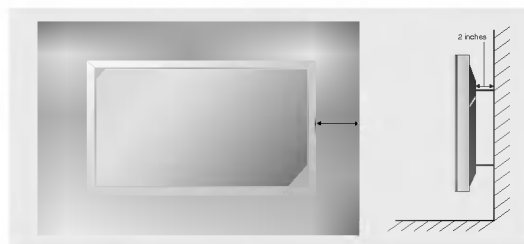

Desktop Pedestal Installation

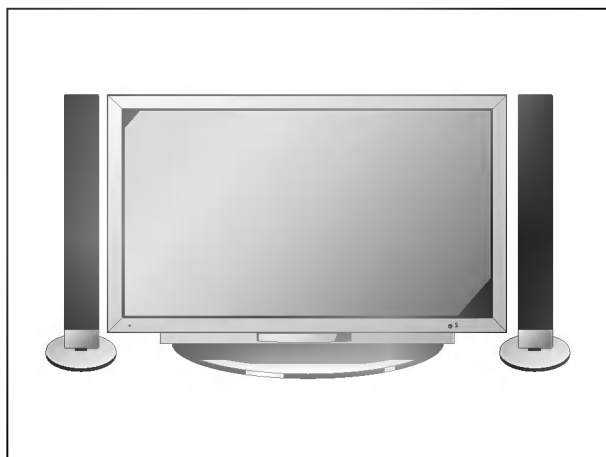

For proper ventilation, allow a clearance of 4" on each side and the top, 2.36" on the bottom, and 1.18" from the wall. Detailed installation instructions are included in the optional Desktop Stand Installation and Setup Guide available from your dealer.

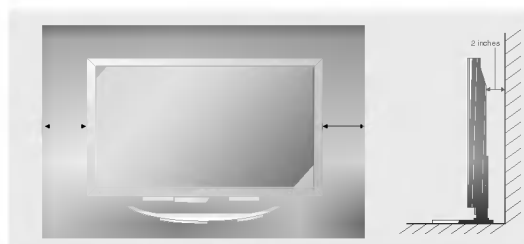

Installation Instructions continued

Wall Mount: Vertical installation (MP-50PZ45M/45V/91M/91V series models only)



Detailed installation instructions are included in the optional Vertical Wall Mounting Bracket Installation and Setup Guide available from your dealer.

NOTE: When installing the monitor vertically, the front panel controls must be in the left side position.



When installing the monitor vertically, you have to change the OSD display mode so that the menus will appear correctly and also to protect the monitor from overheating (Refer to P. 19).

External Equipment Connections

NOTE: Not all cables shown are included with the plasma display.

- To avoid picture noise (interference), leave an adequate distance between the VCR and Monitor
- Use the ISM Method feature to avoid having a fixed image remain on the screen for a long period of time. Typically a frozen still picture from a VCR. If the 4:3 picture format is used; the fixed image may remain visible on the screen.

How to connect

1. Connect the provided BNC-RCA adapter to the monitor's VIDEO INPUT.
2. Connect the audio and video cables from the VCR's output jacks to the monitor input jacks, as shown in the figure.

When connecting the monitor to VCR, match the jack colors (Video = yellow, Audio Left = white, and Audio Right = red).

Mono VCR: Connect the video output cable from the VCR to the VIDEO input on the monitor.

S-VIDEO VCR: Connect the S-Video output cable from the VCR to the S-VIDEO input on the monitor. (Note that S-Video offers higher quality).

How to use

1. Insert a video tape into the VCR and press PLAY on the VCR. (Refer to the VCR owner's manual.)
2. Use the **INPUT SELECT** button on the remote control to select **Video**.
(If connected to S-VIDEO, select the **S-Video** input source.)

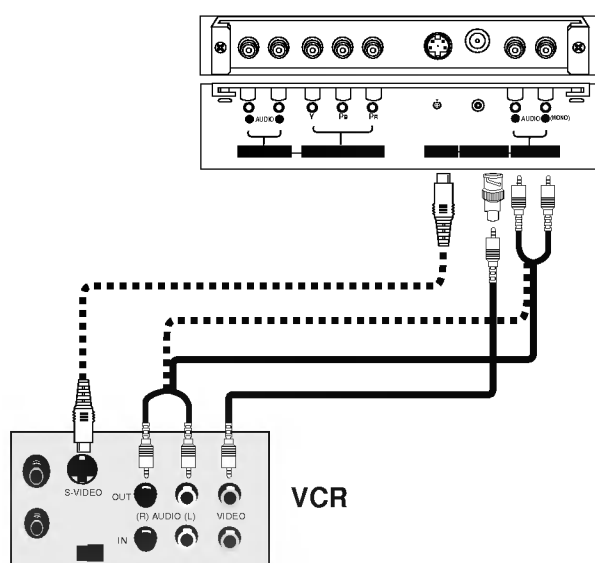

- After subscribing to a cable TV service from a local provider and installing a converter, you can watch cable TV programming. The monitor cannot display TV programming unless a TV tuner device or cable TV converter box is connected to the Monitor.
- For further information regarding cable TV service, contact your local cable TV service provider(s).

How to connect

1. Connect the provided BNC-RCA adapter to the monitor's VIDEO INPUT.
2. Connect the audio and video cables from the Cable Box's output jacks to the monitor input jacks, as shown in the figure.

When connecting the monitor to a Cable Box, match the jack colors (Video = yellow, Audio Left = white, and Audio Right = red).

How to use

1. Use the **INPUT SELECT** button on the remote control to select **Video**.
2. Select your desired channel with the remote control for cable box.

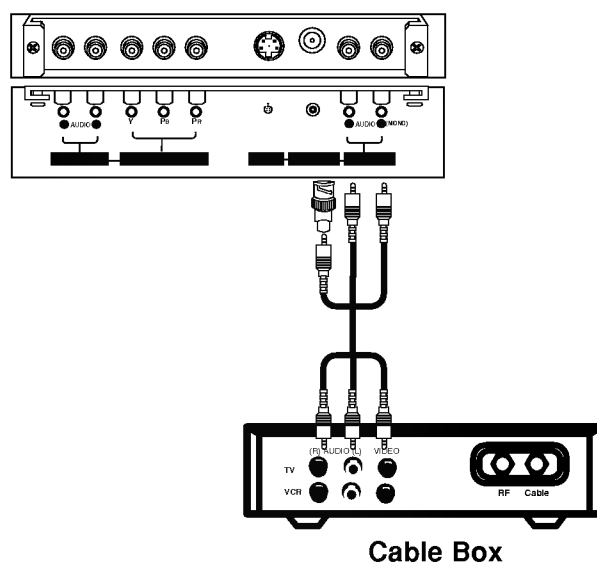

How to connect

1. Connect the provided BNC-RCA adapter to the monitor's VIDEO INPUT.
 2. Connect the audio and video cables from the external equipment's output jacks to the monitor input jacks, as shown in the figure.
- When connecting the monitor to external equipment, match the jack colors (Video = yellow, Audio Left = white, and Audio Right = red).

How to use

1. Use the **INPUT SELECT** button on the remote control to select **Video**.
2. Operate the corresponding external equipment. Refer to external equipment operating guide.

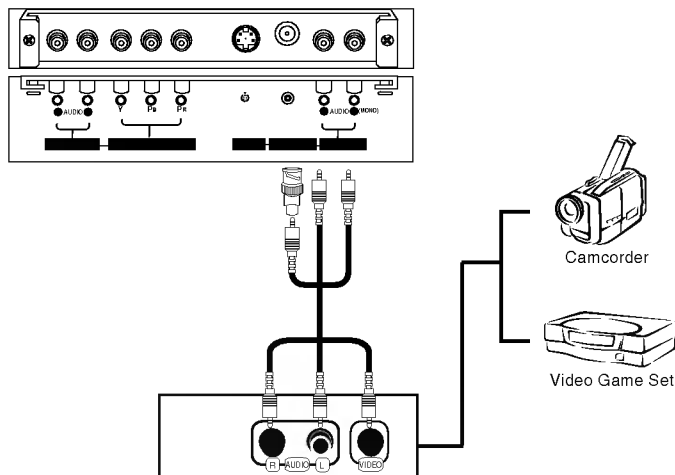

How to connect

1. Connect the DVD video outputs to the COMPONENT (Y, Pb, Pr) INPUT jacks and connect the DVD audio outputs to the AUDIO INPUT jacks on the monitor, as shown in the figure.
2. If your DVD only has an S-Video output jack, connect this to the S-VIDEO input on the monitor and connect the DVD audio outputs to the AUDIO INPUT jacks on the monitor, as shown in the figure.

How to use

1. Turn on the DVD player, insert a DVD.
2. Use the **INPUT SELECT** button on the remote control to select **Component**. (If connected to S-VIDEO, select the **S-Video** external input source.)
3. Refer to the DVD player's manual for operating instructions.

• Component Input ports

To get better picture quality, connect a DVD player to the component input ports as shown below.

Component ports of the Monitor	Y	Pb	Pr
Video output ports of DVD player	Y	Pb	Pr
	Y	B-Y	
	Y	Cb	
	Y	Pb	

- To watch digitally broadcast programs, purchase and connect a digital set-top box.

How to connect

1. Use the monitor's COMPONENT (Y, Pb, Pr) INPUT, RGB or DVI jack for video connections, depending on your set-top box connector. Then, make the corresponding audio connections.

How to use

1. Turn on the digital set-top box. (Refer to the owner's manual for the digital set-top box.)
2. Use **INPUT SELECT** on the remote control to select **Component**, **RGB**, or **DVI**.

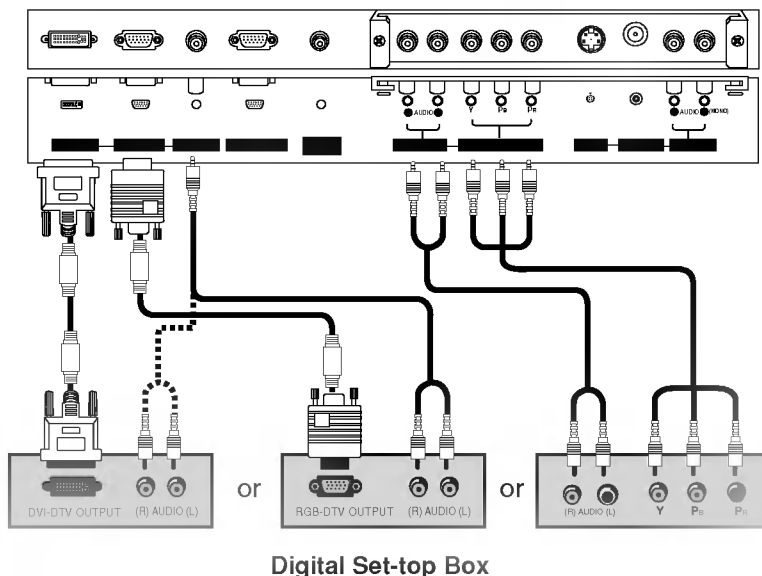

- This monitor provides Plug and Play capability, meaning that the PC adjusts automatically to its settings. The monitor sends configuration information (EDID) to the PC using the Video Electronics Standard Association (VESA) Display Data Channel (DDC) protocol.
- The monitor perceives 640x480, 60Hz as DTV 480p based on the PC graphic card. In this case, change the screen scanning rate for the graphic card.

How to connect

1. To get the best picture quality, adjust the PC graphics card to a 1024x768, 60Hz. Resolutions over UXGA cannot be displayed.
2. Use the monitor's RGB INPUT or DVI (Digital Visual Interface) INPUT port for video connections, depending on your PC connector.
If the graphic card on the PC does not output analog and digital RGB simultaneously, connect only one of either RGB INPUT or DVI INPUT to display the PC on the monitor.
If the graphic card on the PC does output analog and digital RGB simultaneously, set the monitor to either RGB or DVI; (the other mode is set to Plug and Play automatically by the monitor.)
3. Then, make the corresponding audio connections.
If using a sound card, adjust the PC sound as required.

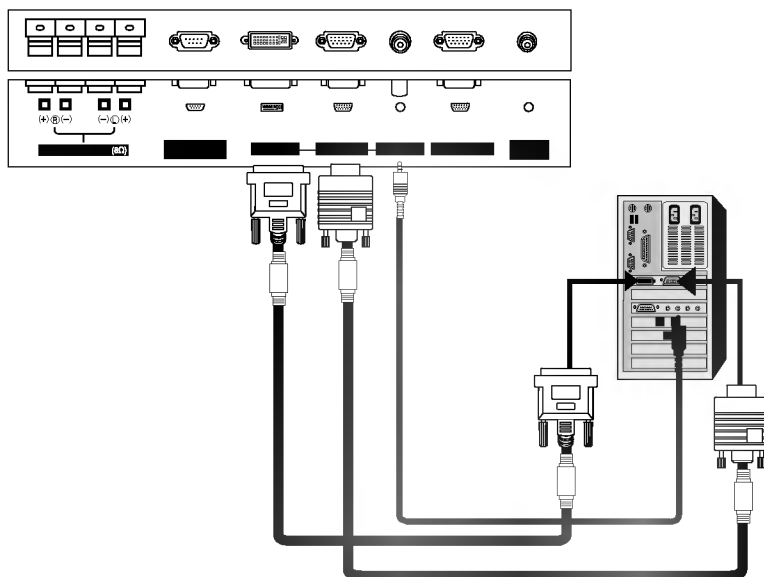

How to use

1. Turn on the PC and the monitor.
2. Turn on the display by pressing the POWER button on the monitor's remote control.
3. Use the **INPUT SELECT** button on the remote control to select **RGB** or **DVI**.
4. Check the image on your monitor. There may be noise associated with the resolution, vertical pattern, contrast or brightness in PC mode. If noise is present, change the PC mode to another resolution, change the refresh rate to another rate or adjust the brightness and contrast on the menu until the picture is clear. If the refresh rate of the PC graphic card can not be changed, change the PC graphic card or consult the manufacturer of the PC graphic card.

- NOTES:**
- Depending on the graphics card, DOS mode may not work if you use a DVI-I cable.
 - Avoid keeping a fixed image on the monitor's screen for a long period of time. The fixed image may become permanently imprinted on the screen. Use the Orbiter screen saver when possible.
 - The synchronization input form for Horizontal and Vertical frequencies is separate.

Monitor Display Specifications (RGB-PC / DVI-PC Mode)

Resolution	Horizontal Frequency(KHz)	Vertical Frequency(Hz)	Resolution	Horizontal Frequency(KHz)	Vertical Frequency(Hz)
640x350	31.468	70.09	852x480	31.500	60.00
	37.861	85.08		35.000	70.00
720x400	31.469	70.08		37.500	75.00
	37.927	85.03	1024x768	48.363	60.00
640x480	31.469	59.94		56.476	70.06
	35.000	66.66		60.023	75.02
	37.861	72.80	1152x864	54.348	60.05
	37.500	75.00		63.995	70.01
43.269	85.00	67.500	75.00		
800x600	35.156	56.25	1280x960	60.000	60.00
	37.879	60.31	1280x1024	63.981	60.02
	46.875	75.00	1360x768	47.700	60.00
	53.674	85.06		59.625	75.02
832x624	49.725	74.55	1366x768	47.700	60.00
848x480	31.500	60.00		59.625	75.02
	35.000	70.00			
	37.500	75.00			

Operation

Turning on the Monitor

Installation

1. Connect power cord correctly.
2. Press the **⓪ ON/OFF** button on the Monitor. At this moment, the Monitor is switched to standby mode. Press the **INPUT SELECT** button on the Monitor or press the **POWER, INPUT SELECT** button on the remote control and then the Monitor will switch on.

(still connected)

1. If the Monitor was turned off with the **⓪ ON/OFF** button on the Monitor
 - Press the **⓪ ON/OFF** button on the Monitor to turn the Monitor on.
2. If the Monitor was turned off with the remote control and then the **⓪ ON/OFF** button on the Monitor
 - Press the **⓪ ON/OFF** button on the Monitor and then press the **INPUT SELECT** button on the Monitor or press the **POWER, INPUT SELECT** button on the remote control to turn the Monitor on.

Menu Language Selection

- The menus can be shown on the screen in the selected language. First select your language.

1. Press the **MENU** button and then use **▲ / ▼** button to select the **SPECIAL** menu.
2. Press the **▶** button and then use **▲ / ▼** button to select **Language**.
3. Press the **▶** button and then use **▲ / ▼** button to select your desired language.
From this point on, the on-screen menus will be shown in the language of your choice.
4. Press the **OK** button to save.

Video Menu Options

- Picture menu adjustment are unique to each input source. Readjust Video menu settings for each following input source as preferred.
 - RGB (PC) / DVI (PC),
 - RGB (DTV) / DVI (DTV) / Component (480p, 720p, 1080i)
 - Video / S-Video / Component (480i)

- APC adjusts the Monitor for the best picture appearance.
- When adjusting Video menu options (contrast, brightness, color, sharpness and tint) manually, APC automatically changes to **User**.

1. Press the **APC** button repeatedly to select the picture appearance setup option as shown below.

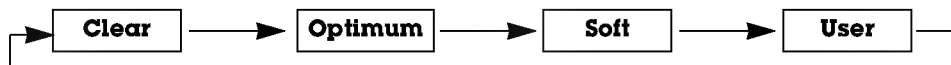

- You can also select **Clear**, **Optimum**, **Soft** or **User** in the **VIDEO** menu.
- **Clear**, **Optimum**, and **Soft** settings are preset for optimum picture quality at the factory and cannot be changed.

- You can adjust picture contrast, brightness, color, sharpness, and tint to the levels you prefer.
- PIP settings are not adjustable.

1. Press the **MENU** button and then use **▲ / ▼** button to select the VIDEO menu.
2. Press the **▶** button and then use **▲ / ▼** button to select the desired picture option (**Contrast**, **Brightness**, **Color**, **Sharpness**, or **Tint**).
3. Press the **▶** button and then use **◀ / ▶** button to make appropriate adjustments.
4. Press the **OK** button to save.



- To initialize values (reset to default settings), select the **Normal** option.
- When adjusting color temperature options (red, green, and blue) manually, ACC automatically changes to **User**.

1. Press the **MENU** button and then use **▲ / ▼** button to select the VIDEO menu.
2. Press the **▶** button and then use **▲ / ▼** button to select **ACC**.
3. Press the **▶** button and then use **▲ / ▼** button to select either **Normal** (Default), **Cool** (Preset), **Warm** (Preset), or **User** (Manual Adjustment).
4. Press the **OK** button to save.

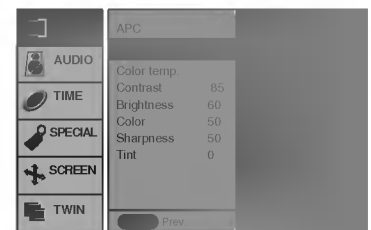

Manual Color Temperature Control (User option)

- You can adjust red, green, and blue to any color temperature you prefer.

1. Press the **MENU** button and then use **▲ / ▼** button to select the VIDEO menu.
2. Press the **▶** button and then use **▲ / ▼** button to select the **Color temp**.
3. Press the **▶** button and then use **▲ / ▼** button to select **Red**, **Green**, or **Blue**.
4. Use the **◀ / ▶** button to make appropriate adjustments.
 - The adjustment range for **Red**, **Green**, and **Blue** is -20 ~ +20.
5. Press the **OK** button to save.



Audio Menu Options

DASP (Digital Auto Sound Processing)

- DASP lets you enjoy the best sound without any special adjustment because the Monitor has the appropriate sound options based on the program content.
- When adjusting sound options (treble, bass, and balance) manually, DASP automatically changes to **User**.

1. Press the **DASP** button repeatedly to select the appropriate sound setup as shown below.



- You can also select **Flat**, **Music**, **Cinema**, **Sports**, or **User** in the **AUDIO** menu.
- **Flat**, **Music**, **Cinema** and **Sports** are preset for good sound quality at the factory and cannot be changed.

1. Press the **MENU** button and then use ▲ / ▼ button to select the **AUDIO** menu.
2. Press the ► button and then use ▲ / ▼ button to select the desired sound option (**Balance**, **Treble**, or **Bass**).
3. Press the ► button and then use ◀ / ▶ button to make appropriate adjustments.
4. Press the **OK** button to save.



- This feature maintains an equal volume level; even if you change channels.

1. Press the **MENU** button and then use ▲ / ▼ button to select the **AUDIO** menu.
2. Press the ► button and then use ▲ / ▼ button to select **AVL**.
3. Press the ► button and then use ▲ / ▼ button to select **On** or **Off**.
4. Press the **OK** button to save.

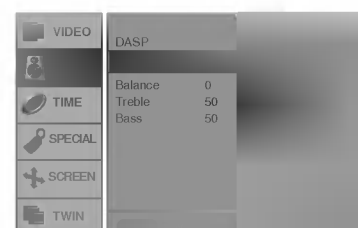

Time Menu Options

- If current time setting is wrong, reset the clock.

1. Press the **MENU** button and then use ▲ / ▼ button to select the TIME menu.
2. Press the ► button and then use ▲ / ▼ button to select **Clock**.
3. Press the ► button and then use ▲ / ▼ button to set the hour.
4. Press the ► button and then use ▲ / ▼ button to set the minutes.
5. Press the **OK** button to save.

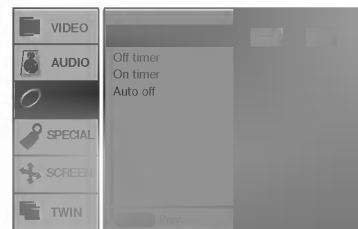

- Timer function operates only if current time has been already set.
 - Off-Timer function overrides On-Timer function if they are set to the same time.

1. Press the **MENU** button and then use ▲ / ▼ button to select the TIME menu.
2. Press the ► button and then use ▲ / ▼ button to select **Off timer** or **On timer**.
3. Press the ► button and then use ▲ / ▼ button to select **On**.
 - To cancel **On/Off timer** function, select **Off**.
4. Press the ► button and then use ▲ / ▼ button to set the hour.
5. Press the ► button and then use ▲ / ▼ button to set the minutes.
- 6. For only On timer function;** Press the ► button and then use ▲ / ▼ button to set volume level.
7. Press the **OK** button to save.

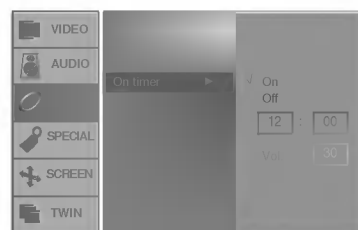

- If there is no input signal, the Monitor turns off automatically after 10 minutes.

1. Press the **MENU** button and then use ▲ / ▼ button to select the TIME menu.
2. Press the ► button and then use ▲ / ▼ button to select **Auto off**.
3. Press the ► button and then use ▲ / ▼ button to select **On** or **Off**.
4. Press the **OK** button to save.

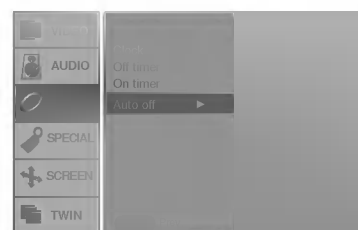

- The sleep timer turns the Monitor off at a preset time. Note that this setting is cleared when the monitor is turned off.

1. Press the **SLEEP** button repeatedly to select the number of minutes. First the **L^{zz} --- Min** option appears on the screen, followed by the following sleep timer options: 10, 20, 30, 60, 90, 120, 180, and 240 minutes.
2. When the number of minutes you want is displayed on the screen, press the **OK** button. The timer begins to count down from the number of minutes selected.
3. To check the remaining minutes before the monitor turns off, press the **SLEEP** or **OK** button once.
4. To cancel the Sleep Timer, press the **SLEEP** button repeatedly until **L^{zz} --- Min** appears.

Special Menu Options

- The monitor can be set up so that it can only be used with the remote control.
- This feature can be used to prevent unauthorized viewing by disabling the front panel controls.
- This Monitor is programmed to remember which option it was last set to even if you turn the monitor off.

1. Press the **MENU** button and then use **▲ / ▼** button to select the **SPECIAL** menu.
2. Press the **▶** button and then use **▲ / ▼** button to select **Key lock**.
3. Press the **▶** button and then use **▲ / ▼** button to select **On** or **Off**.

- When you select **On**, the display '▲ Key lock' appears on the screen if any button on the front panel is pressed.

4. Press the **OK** button to save.

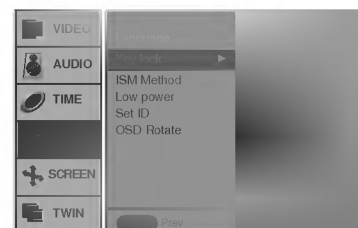

-In setting **Key lock 'On'**, if the monitor is turned off with the remote control, press the **INPUT SELECT** button on the monitor or **POWER, INPUT SELECT** on the remote control to turn the monitor on.

ISM (Image Sticking Minimization) Method

- A frozen still picture from a PC/video game displayed on the screen for prolonged periods will result in an ghost image remaining; even when you change the image. Avoid allowing a fixed image to remain on the Monitor's screen for a long period of time.

1. Press the **MENU** button and then use **▲ / ▼** button to select the **SPECIAL** menu.
2. Press the **▶** button and then use **▲ / ▼** button to select **ISM Method**.
3. Press the **▶** button and then use **▲ / ▼** button to select either **Normal**, **White wash**, **Orbiter**, or **Inversion**.

• Normal

If image sticking is never a problem, ISM is not necessary - set to Normal.

• White wash

White Wash removes permanent images from the screen. Note: An excessive permanent image may be impossible to clear entirely with White Wash. To return to normal viewing, press the any button.

• Orbiter

Orbiter may help prevent ghost images. However, it is best not to allow any fixed image to remain on the screen. To avoid a permanent image on the screen, the image will move every 1 minutes: Right → Right → Downside → Downside → Left → Left → Upside → Upside.

• Inversion

Inversion will automatically invert the plasma display panel color every 30 minutes.

4. Press the **OK** button to save.

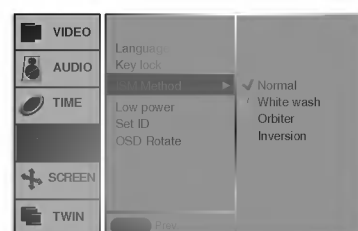

- Low power reduces the plasma display's power consumption.

1. Press the **MENU** button and then use **▲ / ▼** button to select the **SPECIAL** menu.
2. Press the **▶** button and then use **▲ / ▼** button to select **Low power**.
3. Press the **▶** button and then use **▲ / ▼** button to select **On** or **Off**.

- When you select **On**, the screen darkens.

4. Press the **OK** button to save.

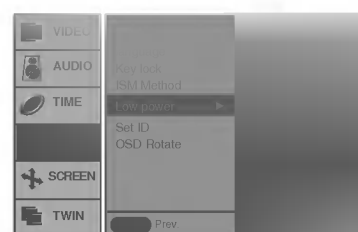

Menu Rotation for Vertical Viewing (MP-50PZ45M/45V/91M/91V series models only)

1. Press the **MENU** button and then use the **▲ / ▼** button to select the **SPECIAL** menu.
2. Press the **▶** button and then use the **▲ / ▼** button to select **OSD Rotate**.
3. Press the **▶** button and then use the **▲ / ▼** button to select **Normal** or **Rotate**.

- Select **Normal**, if the monitor was installed horizontally.
- Select **Rotate**, if the monitor was installed vertically.

4. Press the **OK** button to save.

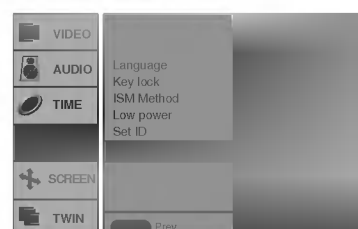

Screen Menu Options

- RGB (PC) mode only; This function doesn't work for RGB-DTV.
- Automatically adjusts picture position and minimizes image shaking.
- After adjustment, if the image is still not correct, your Monitor is functioning properly but needs further adjustment.
- The **Auto config.** and **Manual config.** are not active in DVI mode.

1. Press the **MENU** button and then use **▲ / ▼** button to select the SCREEN menu.
2. Press the **▶** button and then use **▲ / ▼** button to select **Auto config.**
3. Press the **▶** button to run Auto configure.
 - When **Auto config.** has finished, **OK** will be shown on screen.
 - If the position of the image is still not correct, try Auto adjustment again.
4. In RGB (PC) mode, if the image needs to be adjusted more after using **Auto config.**, you can make further adjustments with the **Manual config.** option.

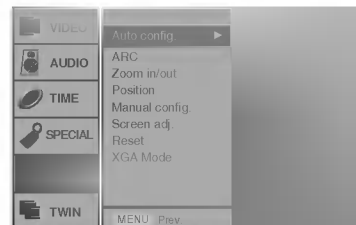

- Caution: If a 4:3 fixed image is on the screen for a long time, it may remain visible.
- Set every aspect ratio for RGB 480p, DVI 480p, Component 480i/480p, Video, and S-Video sources.
- Use 4:3, or 16:9 for other input sources.

1. Press the **ARC** button repeatedly to select the desired picture format. You can also adjust **ARC** in the SCREEN menu.
 - **4:3**
 - Choose **4:3** when you want to view a picture with an original 4:3 aspect ratio, with black bars appearing at both the left and right sides.
 - **16:9**
 - Choose **16:9** when you want to adjust the picture horizontally, in a linear proportion to fill the entire screen.
 - **Horizon**
 - Choose **Horizon** when you want to adjust the picture in a non-linear proportion, that is, more enlarged at both sides, to create a spectacular view.
 - **Zoom**
 - Choose **Zoom** when you want to view the picture without any alteration. However, the top and bottom portions of the picture will be cropped.

- When enlarging or reducing the picture, the image may become distorted.

1. Use **ZOOM+/ZOOM-** button to enlarge or reduce the picture size.
 - Zoom adjustment range is 100~300.
2. Adjust the main picture position using the **▲ / ▼ / ◀ / ▶** buttons while in enlarged picture mode.

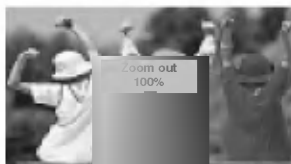

- Enlarges the picture in correct proportions.
- Split Zoom can be used for all input sources.
- In 2-Split Zoom mode, you can only move the image up or down.
- If a screen is enlarged, a screen can move without selecting section of screen Split Zoom.
- It's not available to use this function if **OSD Rotate** is set to the **Rotate** option.

1. Press the **SPLIT ZOOM** button repeatedly to select either 2, 4, or 9 Split Zoom.



2. Press the number button corresponding to the section you wish to enlarge. You can move within the enlarged image with the **▲ / ▼ / ◀ / ▶** button. To return to normal viewing, press the **SPLIT ZOOM** button again.



Example of choosing 5.



Section 5 is enlarged to fill the screen.

- This function works in the following mode:
RGB-PC, RGB-DTV (480p,720p,1080i), COMPONENT (480p,720p,1080i).

1. Press the **MENU** button and then use **▲ / ▼** button to select the **SCREEN** menu.
2. Press the **▶** button and then use **▲ / ▼** button to select **Position**.
3. Press the **▶** button and then use **▲ / ▼ / ◀ / ▶** button to adjust the position.
4. Press the **OK** button to save.

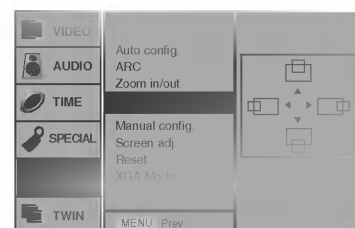

- If the image still isn't clear after auto adjustment and especially if characters are still jittery, adjust the picture **Phase** manually.
- To correct the screen size, adjust **Clock**.

1. Press the **MENU** button and then use **▲ / ▼** button to select the **SCREEN** menu.
2. Press the **▶** button and then use **▲ / ▼** button to select **Manual config.**
3. Press the **▶** button and then use **▲ / ▼** button to to select **Phase** or **Clock**.
4. Use the **◀ / ▶** button to make appropriate adjustments.
 - The **Phase** adjustment range is 0 ~ 31.
 - The **Clock** adjustment range is -50 ~ +50.
5. Press the **OK** button to save.

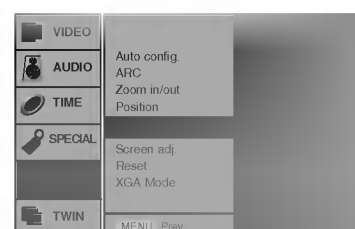

Screen Menu Options continued

Screen Adjustments (Video, S-Video and Component 480i mode only)

- Use this function to correct jittering or picture instability while viewing a video tape.
 1. Press the **MENU** button and then use **▲ / ▼** button to select the SCREEN menu.
 2. Press the **▶** button and then use **▲ / ▼** button to select **Screen adj.**.
 3. Press the **▶** button and then use **▲ / ▼** button to select **TV** or **VCR**.
 - Select the **VCR** option if watching a VCR.
 - Select the **TV** option for other equipment.(Except VCR)
 4. Press the **OK** button to save.

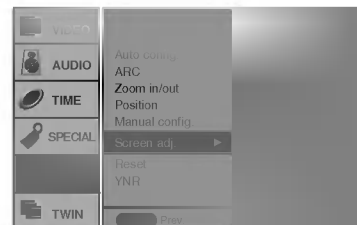

Initializing (Reset to original factory value)

- This function operates in every mode.
- To initialize the adjusted value
 1. Press the **MENU** button and then use **▲ / ▼** button to select the SCREEN menu.
 2. Press the **▶** button and then use **▲ / ▼** button to select **Reset**.
 3. Press the **▶** button.
 - You can initialize Zoom in/out, Manual config., Position, Split zoom, PIP size, PIP position and sub picture size for twin picture.

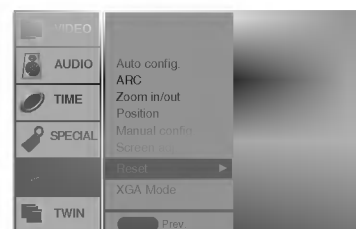

Selecting Wide VGA/XGA mode (RGB-PC, DVI-PC mode only)

- To see a normal picture, match the resolution of RGB XGA mode (1024x768, 1360x768, 1366x768) with the selection for XGA mode and the resolution of RGB VGA mode (640x480, 848x480, 852x480) with the selection for VGA mode in the SCREEN menu.
- If the input source is RGB VGA mode, the screen menu option is changed from **XGA mode** to **VGA mode** automatically.
 1. Press the **MENU** button and then use **▲ / ▼** button to select the SCREEN menu.
 2. Press the **▶** button and then use **▲ / ▼** button to select **VGA mode/XGA mode**.
 3. Press the **▶** button and then use **▲ / ▼** button to select the desired VGA/XGA resolution.
 4. Press the **OK** button to save.

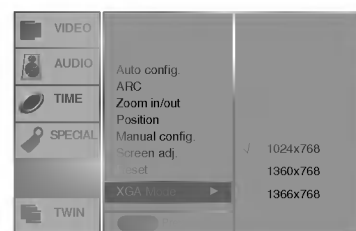

Luminance Noise Reduction (Video, S-Video and Component 480i modes only)

- Use YNR to reduce the picture noise which may appear on the screen.
 1. Press the **MENU** button and then use **▲ / ▼** button to select the SCREEN menu.
 2. Press the **▶** button and then use **▲ / ▼** button to select **YNR**.
 3. Press the **▶** button and then use **▲ / ▼** button to select **On** or **Off**.
 4. Press the **OK** button to save.

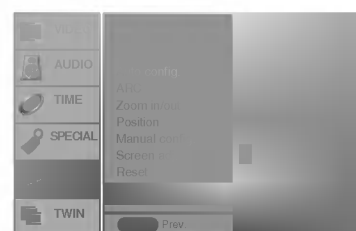

PIP (Picture-In-Picture) Feature

- PIP lets you view 2 different inputs (sources) on your monitor screen at the same time. One source will be large, and the other source will show a smaller inset image.

Press the **PIP** button repeatedly to turn PIP on or off.



Press the **WIN.SIZE** button and then use ◀ / ▶ button to change the sub picture size.



Press the **PIP ARC** button. The sub picture appears as shown.

Press the **SWAP** button to switch the main and sub pictures.

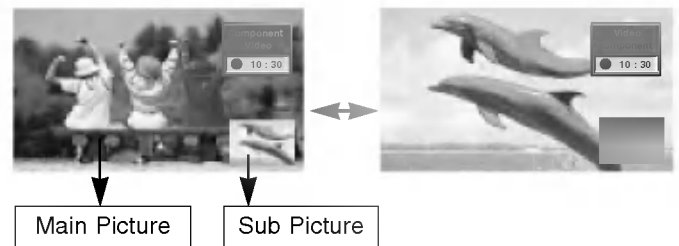
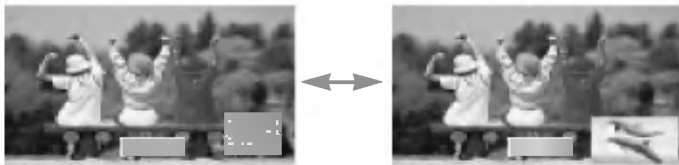

Press the **WIN.POSITION** button.

Press the ▲ / ▼ / ◀ / ▶ button repeatedly until desired position is achieved. The sub picture moves up/down/left/right.



Selecting an Input Signal Source for the PIP

Use the **SUB INPUT** button to select the input source for the sub picture.

Main Picture Source	Available Sub Picture Sources
Video	S-Video, Component 480i/480p/720p/1080i, RGB, and DVI
S-Video	Video, Component 480i/480p/720p/1080i, RGB, and DVI
Component 480i	Video, S-Video, RGB, and DVI
Component 480p/720p/1080i	Video and S-Video
RGB and DVI	Component 480i, Video, and S-Video

Twin Picture Setup Option

- As the name suggests, this mode splits the screen into 2, allowing 2 picture sources to be shown on the monitor screen at the same time. Each source is given half the screen.

Press the **TWIN PICTURE** button repeatedly to select one of the Twin Picture options.



Press the **WIN.SIZE** button.

- Use the ◀ / ▶ button to change the sub picture size.
- Using the WIN.SIZE function in Twin Picture mode, main and sub picture sizes are changed simultaneously.
Using the WIN.SIZE function in PIP mode, sub picture size is changed.
- WIN.POSITION is not functional in Twin Picture mode.

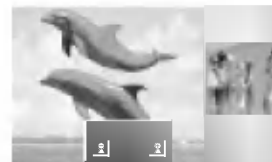

Use the **SWAP** button to switch the main and sub pictures in twin picture mode.

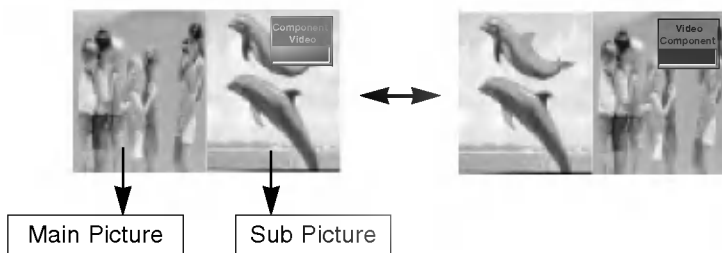

Use the **SUB INPUT** button to select the input source for the sub picture.

Main Picture Source	Available Sub Picture Sources
Video	S-Video, Component 480i/480p/720p/1080i, RGB, and DVI
S-Video	Video, Component 480i/480p/720p/1080i, RGB, and DVI
Component 480i	Video, S-Video, RGB, and DVI
Component 480p/720p/1080i	Video and S-Video
RGB and DVI	Component 480i, Video, and S-Video

External Control Device Setup

- Connect the RS-232C input jack to an external control device (such as a computer or an A/V control system) and control the Monitor's functions externally.
- Connect the serial port of the control device to the RS-232C jack on the Monitor back panel.
- RS-232C connection cables are not supplied with the Monitor.

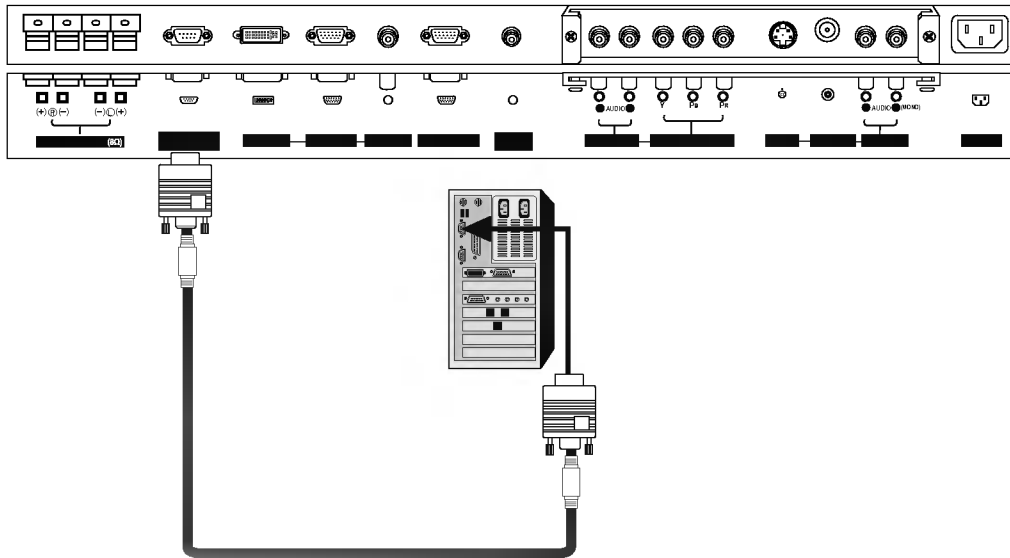

No.	Pin Name
1	No Connection
2	RXD (Receive data)
3	TXD (Transmit data)
4	DTR (DTE side ready)
5	GND
6	DSR (DCE side ready)
7	RTS (Ready to send)
8	CTS (Clear to send)
9	No Connection

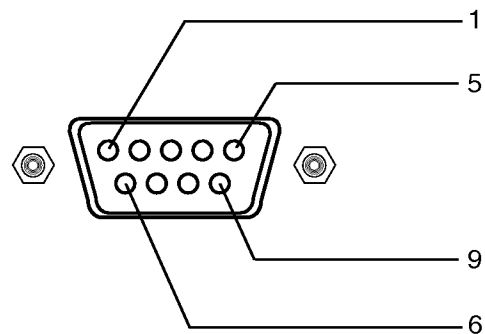

7-Wire Configuration
(Standard RS-232C cable)

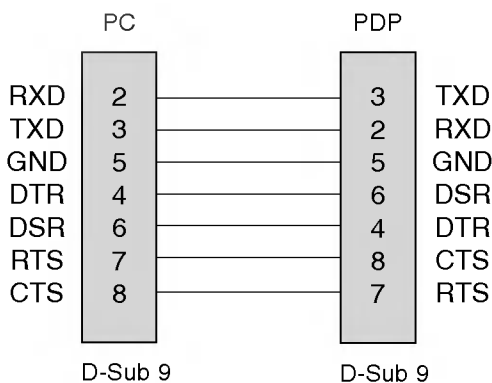

3-Wire Configuration
(Not standard)

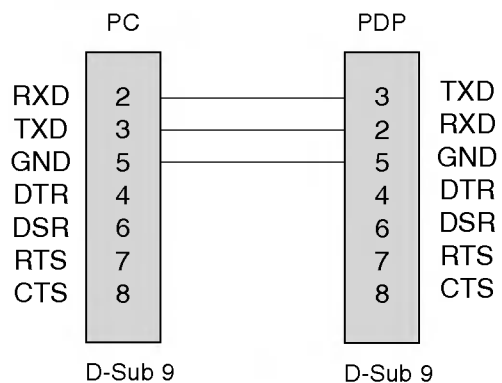

- Use this function to specify a monitor ID number.
- Refer to 'Real Data Mapping 1'. See page 27.

1. Press the **MENU** button and then use the **▲ / ▼** button to select the **SPECIAL** menu.
2. Press the **▶** button and then use **▲ / ▼** button to select **Set ID**.
3. Press the **▶** button and then use **◀ / ▶** button to adjust **Set ID** to choose the desired monitor ID number.
 - The adjustment range of **Set ID**. is 1 ~ 99.



- Baud rate : 115200 bps (UART)
- Data length : 8 bits
- Parity : None
- Stop bit : 1 bit
- Communication code : ASCII code

	COMMAND 1	COMMAND 2	DATA (Hexadecimal)
01. Power	k	a	0 ~ 1
02. Input Select	k	b	0 ~ 4
03. Aspect Ratio	k	c	0 ~ 3
04. Screen Mute	k	d	0 ~ 1
05. Volume Mute	k	e	0 ~ 1
06. Volume Control	k	f	0 ~ 64
07. Contrast	k	g	0 ~ 64
08. Brightness	k	h	0 ~ 64
09. Color	k	i	0 ~ 64
10. Tint	k	j	0 ~ 64
11. Sharpness	k	k	0 ~ 64
12. OSD Select	k	l	0 ~ 1
13. Remote Control Lock Mode	k	m	0 ~ 1
14. PIP/Twin	k	n	0 ~ 3
15. PIP Aspect Ratio	k	o	0 ~ 1
16. Split Zoom	k	p	0 ~ 99
17. PIP Position	k	q	0 ~ 3
18. Treble	k	r	0 ~ 64
19. Bass	k	s	0 ~ 64
20. Balance	k	t	0 ~ 64
21. Color Temperature	k	u	0 ~ 3
22. Red Adjustment	k	v	0 ~ C8
23. Green Adjustment	k	w	0 ~ C8
24. Blue Adjustment	k	\$	0 ~ C8
25. PIP Input Source	k	y	0 ~ 4
26. Abnormal State	k	z	0 ~ a
27. ISM Method	j	p	0 ~ 3
28. Low Power	j	q	0 ~ 1
29. Orbiter Time Setting	j	r	1 ~ FE
30. Orbiter Pixel Setting	j	s	0 ~ 9
31. Picture Size Setting for Twin Picture mode	j	t	0 ~ 64
32. Auto Configure	j	u	1

- Menu doesn't display on screen when setting the 4, 12, 13, and 26 ~ 32.

Transmission

[Command1][Command2][][Set ID][][Data][Cr]

- * [Command 1]: k, j
- * [Command 2]: To control PDP set.
- * [Set ID]: You can adjust the set ID to choose desired monitor ID number in Special menu. Adjustment range is 1 ~ 99. When selecting Set ID '0', every connected PDP set is controlled. Set ID is indicated as decimal (1~99) on menu and as Hexa decimal (0x0~0x63) on transmission/receiving protocol.
- * [DATA]: To transmit command data.
Transmit 'FF' data to read status of command.
- * [Cr]: Carriage Return
ASCII code '0x0D'
- * []: ASCII code 'space (0x20)'

OK Acknowledgement

[Command2][][Set ID][][OK][Data][x]

- * The Monitor transmits ACK (acknowledgement) based on this format when receiving normal data. At this time, if the data is data read mode, it indicates present status data. If the data is data write mode, it returns the data of the PC computer.

Error Acknowledgement

[Command2][][Set ID][][NG][x]

- * The Monitor transmits ACK (acknowledgement) based on this format when receiving abnormal data from non-viable functions or communication errors.

- Data 1: Illegal Code
2: Not supported function
3: Wait more time

08. Brightness (Command2:h)

- ▶ To adjust screen brightness.
You can also adjust brightness in the Video menu.

Transmission

```
[k][h][ ][Set ID][ ][Data][Cr]
```

Data Min : 0 ~ Max : 64

- Refer to 'Real data mapping 1'. See page 27.

Acknowledgement

```
[h][ ][Set ID][ ][OK][Data][x]
```

09. Color (Command2:i)

- ▶ To adjust the screen color.
You can also adjust color in the Video menu.

Transmission

```
[k][i][ ][Set ID][ ][Data][Cr]
```

Data Min : 0 ~ Max : 64

- Refer to 'Real data mapping 1'. See page 27.

Acknowledgement

```
[i][ ][Set ID][ ][OK][Data][x]
```

10. Tint (Command2:j)

- ▶ To adjust the screen tint.
You can also adjust tint in the Video menu.

Transmission

```
[k][j][ ][Set ID][ ][Data][Cr]
```

Data Red : 0 ~ Green : 64

- Refer to 'Real data mapping 1'. See page 27.

Acknowledgement

```
[j][ ][Set ID][ ][OK][Data][x]
```

11. Sharpness (Command2:k)

- ▶ To adjust the screen sharpness.
You can also adjust sharpness in the Video menu.

Transmission

```
[k][k][ ][Set ID][ ][Data][Cr]
```

Data Min: 0 ~ Max: 64

- Refer to 'Real data mapping 1'. See page 27.

Acknowledgement

```
[k][ ][Set ID][ ][OK][Data][x]
```

12. OSD Select (Command2:l)

- ▶ To select OSD (On Screen Display) on/off.

Transmission

```
[k][l][ ][Set ID][ ][Data][Cr]
```

Data 0: OSD off 1: OSD on

Acknowledgement

```
[l][ ][Set ID][ ][OK][Data][x]
```

13. Remote Control Lock Mode (Command2:m)

- ▶ To lock the remote control and front panel controls on the monitor

Transmission

```
[k][m][ ][Set ID][ ][Data][Cr]
```

Data 0: Lock off 1: Lock on

Acknowledgement

```
[m][ ][Set ID][ ][OK][Data][x]
```

- If you're not using the remote control and front panel controls on the monitor, use this mode. When main power is on/off, remote control lock is released.

14. PIP / Twin (Command2:n)

- ▶ To control the PIP (Picture-in-Picture) or Twin Picture.
You can also control the PIP/TWIN using the PIP or Twin PICTURE button on the remote control or in the Special menu.

Transmission

```
[k][n][ ][Set ID][ ][Data][Cr]
```

Data 0: PIP/DW off 2: DW1
1: PIP 3: DW2Acknowledgement

```
[n][ ][Set ID][ ][OK][Data][x]
```

15. PIP Aspect Ratio (Command2:o)

- ▶ To select the PIP picture format.
You can also select the PIP picture format using PIP ARC on the remote control.

Transmission

```
[k][o][ ][Set ID][ ][Data][Cr]
```

Data 0: 4:3 1: 16:9

Acknowledgement

```
[o][ ][Set ID][ ][OK][Data][x]
```

16. Split Zoom (Command2:p)

- ▶ To operate split zoom function and select the split zoom section number.

Transmission

```
[k][p][ ][Set ID][ ][Data][Cr]
```

Data Min: 0 ~ Max: 99

- Refer to 'Real data mapping 2'.

Acknowledgement

```
[p][ ][Set ID][ ][OK][Data][x]
```

*** Real Data Mapping 2**

0 : Reset split zoom
21: Selection 1 of 2 split zoom
24: Selection 4 of 2 split zoom
41: Selection 1 of 4 split zoom
42: Selection 2 of 4 split zoom
44: Selection 4 of 4 split zoom
45: Selection 5 of 4 split zoom
91: Selection 1 of 9 split zoom
⋮
99: Selection 9 of 9 split zoom

17. PIP Position (Command2:q)

- ▶ To select sub picture position for PIP.
You can also adjust the sub picture position using WIN.POSITION on the remote control or in the Special menu.

Transmission

```
[k][q][ ][Set ID][ ][Data][Cr]
```

Data 0: Right down on screen
1: Left down on screen
2: Left up on screen
3: Right up on screen

Acknowledgement

```
[q][ ][Set ID][ ][OK][Data][x]
```

18. Treble (Command2:r)

- ▶ To adjust treble.
You can also adjust treble in the Audio menu.

Transmission

```
[k][r][ ][Set ID][ ][Data][Cr]
```

Data Min: 0 ~ Max: 64

- Refer to 'Real data mapping 1'. See page 27.

Acknowledgement

```
[r][ ][Set ID][ ][OK][Data][x]
```

19. Bass (Command2:s)

- ▶ To adjust bass.
You can also adjust bass in the Audio menu.

Transmission

```
[k][s][ ][Set ID][ ][Data][Cr]
```

Data Min: 0 ~ Max: 64

- Refer to 'Real data mapping 1'. See page 27.

Acknowledgement

```
[s][ ][Set ID][ ][OK][Data][x]
```

20. Balance (Command2:t)

- ▶ To adjust balance.
You can also adjust balance in the Audio menu.

Transmission

```
[k][t][ ][Set ID][ ][Data][Cr]
```

Data Min: 0 ~ Max: 64

- Refer to 'Real data mapping 1'. See page 27.

Acknowledgement

```
[t][ ][Set ID][ ][OK][Data][x]
```

21. Color Temperature (Command2:u)

- ▶ To adjust color temperature.
You can also adjust ACC in the Video menu.

Transmission

```
[k][u][ ][Set ID][ ][Data][Cr]
```

Data 0: Normal 1: Cool 2: Warm 3: User

Acknowledgement

```
[u][ ][Set ID][ ][OK][Data][x]
```

22. Red Adjustment (Command2:v)

- ▶ To adjust red in color temperature.

Transmission

```
[k][v][ ][Set ID][ ][Data][Cr]
```

Data Min: 0 ~ Max: C8

- Refer to 'Real data mapping 3' as shown below.

Acknowledgement

```
[v][ ][Set ID][ ][OK][Data][x]
```

23. Green Adjustment (Command2:w)

- ▶ To adjust green in color temperature.

Transmission

```
[k][w][ ][Set ID][ ][Data][Cr]
```

Data Min: 0 ~ Max: C8

- Refer to 'Real data mapping 3' as shown below.

Acknowledgement

```
[w][ ][Set ID][ ][OK][Data][x]
```

24. Blue Adjustment (Command2:\$)

- ▶ To adjust blue in color temperature.

Transmission

```
[k][$][ ][Set ID][ ][Data][Cr]
```

Data Min: 0 ~ Max: C8

- Refer to 'Real data mapping 3' as shown below.

Acknowledgement

```
[$][ ][Set ID][ ][OK][Data][x]
```

*** Real data mapping 3**

```
0 : -20
5 : -19
A : -18
⋮
5F: -1
64: 0
69: +1
⋮
C3: +19
C8: +20
```

25. PIP Input Select (Command2:y)

► To select input source for sub picture in PIP mode.

Transmission

[k][y][][Set ID][][Data][Cr]

Data 0: RGB 1: Component
 2: Video 3: S-video 4: DVI

Acknowledgement

[y][][Set ID][][OK][Data][x]

26. Abnormal State (Command2:z)

► To recognize an abnormal state.

Transmission

[k][z][][Set ID][][FF][Cr]

Data FF:Read

Acknowledgement

[z][][Set ID][][OK][Data][x]

Data 0: Normal (Power on and signal exist)
 1: No signal (Power on)
 2: Turn the monitor off by remote control
 3: Turn the monitor off by sleep time function
 4: Turn the monitor off by RS-232C function
 5: 5V down
 6: AC down
 7: Turn the monitor off by Fan Alarm function
 8: Turn the monitor off by off time function
 9: Turn the monitor off by auto off function
 a: Turn the monitor off by AV board detect

27. ISM Method (Command2:p)

► To avoid having a fixed image remain on screen.

Transmission

[i][p][][Set ID][][Data][Cr]

Data 0: Normal 2: Orbiter
 1: White wash 3: Inversion

Acknowledgement

[p][][Set ID][][OK][Data][x]

28. Low Power (Command2:q)

► To control the low power function on/off.

Transmission

[i][q][][Set ID][][Data][Cr]

Data 0: Low power off
 1: Low power on

Acknowledgement

[q][][Set ID][][OK][Data][x]

29. Orbiter Time Setting (Command2:r)

► To adjust orbiter operation time term.

Transmission

[i][r][][Set ID][][Data][Cr]

Data Min: 1 ~ Max: FE

Acknowledgement

[r][][Set ID][][OK][Data][x]

30. Orbiter Pixel Setting (Command2:s)

► To adjust pixel number in orbiter function.

Transmission

[i][s][][Set ID][][Data][Cr]

Data Min: 0 ~ Max: 9

Acknowledgement

[s][][Set ID][][OK][Data][x]

31. Picture Size Setting for Twin Picture mode (Command2:t)

► To adjust main picture size in twin picture mode.

Transmission

[i][t][][Set ID][][Data][Cr]

Data Min: 0 ~ Max: 64

- Refer to 'Real data mapping1'. See page 27.

Acknowledgement

[t][][Set ID][][OK][Data][x]

32. Auto Configure (Command2:u)

► To adjust picture position and minimize image shaking automatically. Auto Configure only works in RGB-PC mode.

Transmission

[i][u][][Set ID][][Data][Cr]

Data 1: To set

Acknowledgement

[u][][Set ID][][OK][Data][x]

IR Code

- ▶ Connect your wired remote control to the Remote Control port on the Monitor.

▶ Output waveform

Single pulse, modulated with 37.917KHz signal at 455KHz

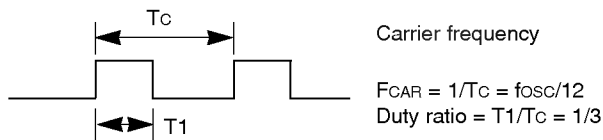

▶ Configuration of frame

- 1st frame

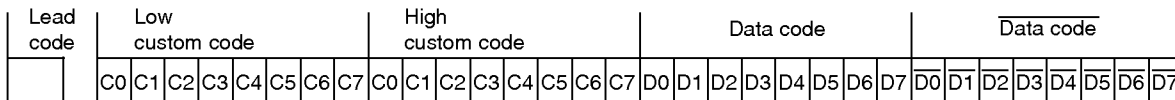

- Repeat frame

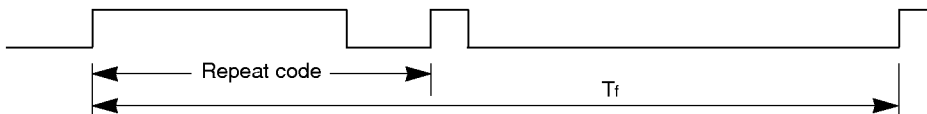

▶ Lead code

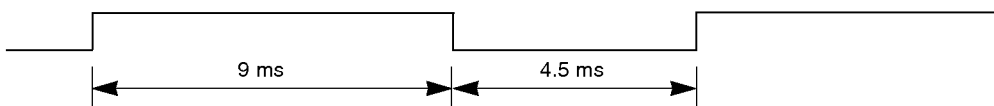

▶ Repeat code

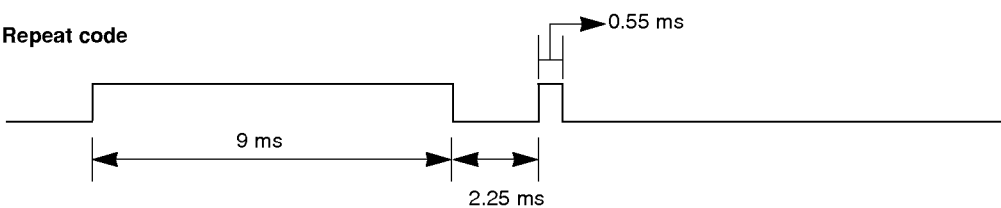

▶ Bit description

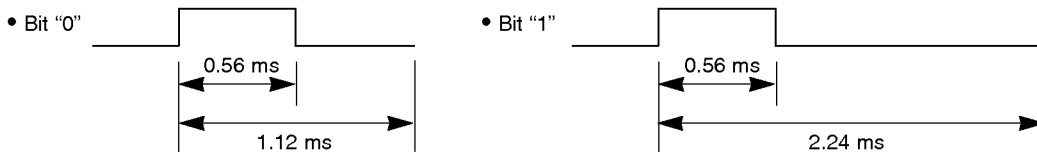

▶ Frame interval : Tf

The waveform is transmitted as long as a key is depressed.

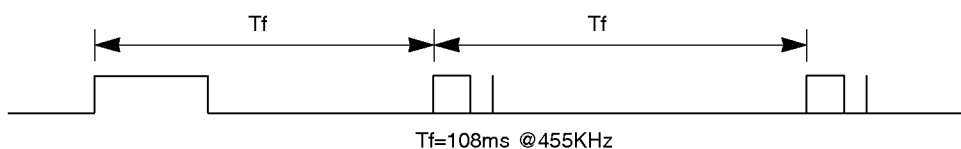

Code (Hexa)	Function	Note
00H	UP (▲)	R/C Button
01H	DOWN (▼)	R/C Button
02H	VOL+ (▶)	R/C Button
03H	VOL- (◀)	R/C Button
08H	POWER On/Off	R/C Button (Power On/Off)
C4H	POWER ON	Discrete IR Code (Only Power On)
C5H	POWER OFF	Discrete IR Code (Only Power Off)
09H	MUTE	R/C Button
10H	Number Key 0	R/C Button
11H	Number Key 1	R/C Button
12H	Number Key 2	R/C Button
13H	Number Key 3	R/C Button
14H	Number Key 4	R/C Button
15H	Number Key 5	R/C Button
16H	Number Key 6	R/C Button
17H	Number Key 7	R/C Button
18H	Number Key 8	R/C Button
19H	Number Key 9	R/C Button
0BH	ALL INPUT SELECT	R/C Button (RGB/DVI/Video/S-Video/Component)
D5H	RGB	Discrete IR Code (Input RGB Selection)
C6H	DVI	Discrete IR Code (Input DVI Selection)
5AH	VIDEO	Discrete IR Code (Input Video Selection)
D8H	S-VIDEO	Discrete IR Code (Input S-video Selection)
BFH	COMPONENT	Discrete IR Code (Input Component Selection)
0EH	SLEEP	R/C Button
44H	OK (■)	R/C Button
43H	MENU	R/C Button
52H	DASP	R/C Button
4DH	APC	R/C Button
60H	PIP	R/C Button
61H	PIP INPUT	R/C Button
63H	SWAP	R/C Button (PIP/TWIN Exchange)
64H	PIP ARC	R/C Button (4:3/16:9)
6BH	TWIN PICTURE	R/C Button
40H	ZOOM +	R/C Button
41H	ZOOM -	R/C Button
69H	Window Size	R/C Button
6AH	Window Position	R/C Button
7BH	Split Zoom	R/C Button
79H	ARC	R/C Button(4:3/16:9/Zoom Mode Selection)
76H	ARC (4:3)	Discrete IR Code (Only 4:3 mode)
77H	ARC (16:9)	Discrete IR Code (Only 16:9 mode)
AFH	ARC (ZOOM)	Discrete IR Code (Only ZOOM mode)
99H	Auto configure	Discrete IR Code (Only RGB-PC mode)

Troubleshooting Checklist

No picture & No sound

- Check whether the Monitor is turned on.
- Power cord inserted into wall outlet?
- Test the wall power outlet, plug other product's power cord into the wall outlet where the Monitor's power cord was plugged in.

Picture OK & No sound

- Press the **VOLUME** (▶) button.
- Sound muted? Press **MUTE** button.

The remote control doesn't work

- Check to see if there is any object between the Plasma Display and the remote control causing obstruction.
- Are batteries installed with correct polarity (+ to +, - to -)? (Refer to p.8)
- Install new batteries. (Refer to p.8)

Picture appears slowly after switching on

- This is normal, the image is muted during the plasma display startup process. Please contact your service center, if the picture has not appeared after five minutes.

No or Poor color or Poor picture

- Select **Color** in the **VIDEO** menu and press the **VOLUME** (▶) button. (Refer to p.16)
- Keep a sufficient distance between the Monitor and the VCR.
- Activate any function to restore the brightness of the picture. (If still picture is on the screen for more than 5 minutes, the screen gets dark.)

Horizontal/vertical bars or picture shaking

- Check for local interference such as an electrical appliance or power tool.

No output from one of the speakers

- Adjust **Balance** in the **AUDIO** menu. (Refer to p.17)

Unusual sound from inside the monitor

- A change in ambient humidity or temperature may result in an unusual noise when the plasma display is turned on or off and does not indicate a fault with the monitor.

Product Specifications

MODEL	MP-50PZ44/44A/44B/44K/44R/44S MP-50PZ44H/44HA/44HB/44HK/44HR/44HS MP-50PZ45M/45MA/45MB/45MK/45MR/45MS MP-50PZ45V/45VA/45VB/45VK/45VR/45VS MP-50PZ90/90A/90B/90K/90R/90S MP-50PZ90H/90HA/90HB/90HK/90HR/90HS MP-50PZ91M/91MA/91MB/91MK/91MR/91MS MP-50PZ91V/91VA/91VB/91VK/91VR/91VS
Width (inches / mm)	48.2 / 1223
Height (inches / mm)	28.9 / 734
Depth (inches / mm)	4.1 / 105
Weight (pounds / kg)	95.2 / 43.2
Power requirement	AC100-240V, 50/60Hz
Resolution	1366 x 768 (Dot)
Color	16,770,000 (256 steps of each R, G and B)
Operating Temperature Range	32 ~ 104°F (0 ~ 40°C)
Operating Humidity Range	Less than 80%

- The specifications shown above may be changed without notice for quality improvement.

Notes