



website <http://www.lgservice.com>

LG

Room Air Conditioner

OWNER'S MANUAL

LG

IMPORTANT

Please read the operating instructions and safety precautions carefully and thoroughly before installing and operating your room air conditioner.

PRECAUTIONS

Pay close attention to precautions in order to prevent potential hazards and damage from misuse or improper installation. LG is not responsible for any damages caused by misuse of the product.

TABLE OF CONTENTS

Safety Precautions.....	3
Before Operation	7
Introduction	8
Installation	9
Operating Instructions	14
Maintenance and Service	21



FOR YOUR RECORDS

Write the model and serial numbers here:

Model # _____

Serial # _____

You can find them on a label on the side of each unit.

Dealer's Name _____

Date Purchased _____

■ Staple your receipt to this page in the event you need it to prove date of purchase or for warranty issues.



READ THIS MANUAL

Inside you will find many helpful hints on how to use and maintain your air conditioner properly. Just a little preventive care on your part can save you a great deal of time and money over the life of your air conditioner.

You'll find many answers to common problems in the chart of troubleshooting tips. If you review our chart of

Troubleshooting Tips first, you may not need to call for service at all.



PRECAUTION

- Contact the authorized service technician for repair or maintenance of this unit.
- Contact the installer for installation of this unit.
- The air conditioner is not intended for use by young children or invalids without supervision.
- Young children should be supervised to ensure that they do not play with the air conditioner.
- When the power cord is to be replaced, replacement work shall be performed by authorized personnel only using only genuine replacement parts.
- Installation work must be performed in accordance with the National Electric Code by qualified and authorized personnel only.



Safety Precautions



To prevent injury to the user or other people and property damage, the following instructions must be followed.

■ Incorrect operation due to ignoring instruction will cause harm or damage. The seriousness is classified by the following indications.

⚠ WARNING This symbol indicates the possibility of death or serious injury.

⚠ CAUTION This symbol indicates the possibility of injury or damage to properties only.

■ Meanings of symbols used in this manual are as shown below.

	Be sure not to do.
	Be sure to follow the instruction.

⚠ WARNING

■ Installation

Don't use a power cord, a plug or a loose socket which is damaged.

- Otherwise, it may cause a fire or electrical shock.

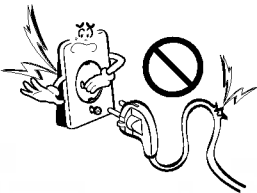

Always plug into a grounded outlet.

- Otherwise, it may cause a fire or electrical shock.

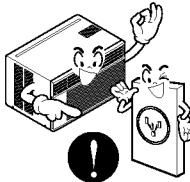

Do not modify or extend the power cord length.

- It will cause electric shock or fire due to heat generation.

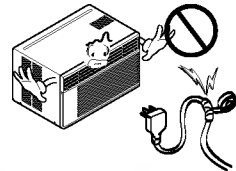

Do not disassemble or modify products.

- It may cause failure and electric shock.

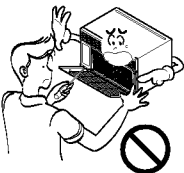

Be caution when unpacking and installing.

- Sharp edges may cause injury.

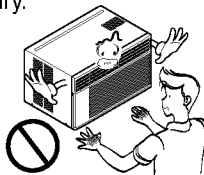

Do not use the power cord near flammable gas or combustibles such as gasoline, benzene, thinner, etc.

- It may cause explosion or fire.

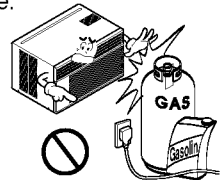

■ Operation

Do not place heavy object on the power cord and take care so that the cord should not be pressed.

- There is danger of fire or electric shock.

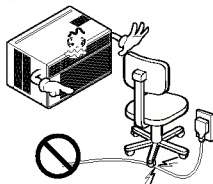

Do not share the outlet with other appliances.

- It will cause electric shock or fire due to heat generation.

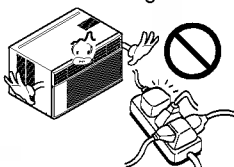

Take the power plug out if necessary, holding the head of the plug and do not touch it with wet hands.

- Otherwise, it may cause a fire or electrical shock.



Do not place the power cord near a heater.

- It may cause fire and electric shock.

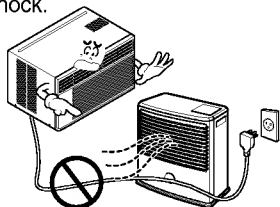

Do not allow water to run into electric parts.

- It will cause failure of machine or electric shock.



Use a soft cloth to clean. Do not use wax, thinner, or a strong detergent.

- The appearance of the air conditioner may deteriorate, change color, or develop surface flaws.



Unplug the unit if strange sounds, odors, or smoke come from it.

- Otherwise it may cause fire and electric shock accident.

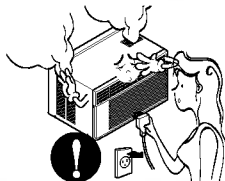

Do not open the suction inlet grill of the product during operation.

- Otherwise, it may electrical shock and failure.

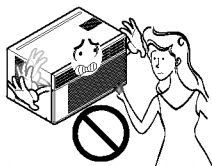

If water enters the product, turn off the power switch of the main body of appliance. Contact service center after taking the power-plug out from the socket.

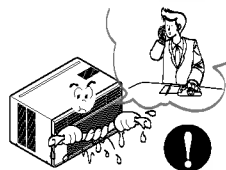

Ventilate the room well when using this appliance together with a stove, etc.

- An oxygen shortage may occur.

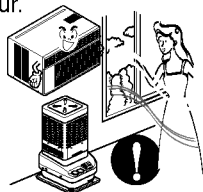

Turn off the power and breaker firstly when cleansing the unit.

- Since the fan rotates at high speed during operation, it may cause injury.

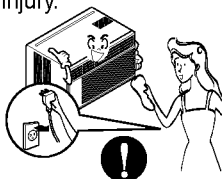

Turn off the main power switch when not using it for a long time.

- Prevent accidental startup and the possibility of injury.

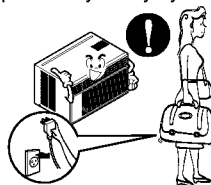

Do not operate or stop the unit by inserting or pulling out the power plug.

- It will cause electric shock or fire due to heat generation.

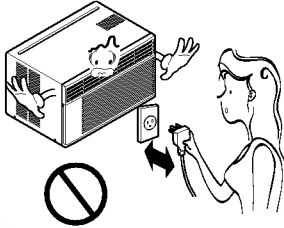

Do not damage or use an unspecified power cord.

- It will cause electric shock or fire.

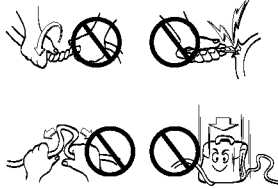

Do not operate with wet hands or in damp environment.

- It will cause electric shock.

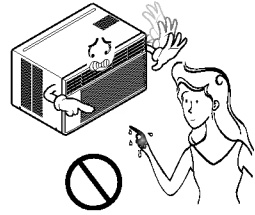

Hold the plug by the head when taking it out.

- It may cause electric shock and damage.

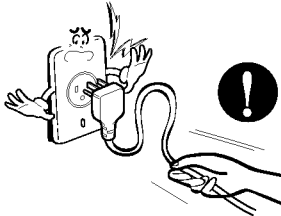

When gas leaks, open the window for ventilation before operating the unit.

- Otherwise, it may cause explosion, and a fire.

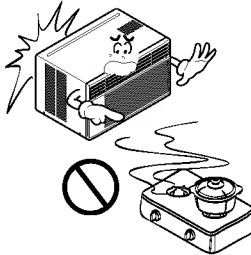

Never touch the metal parts of the unit when removing the filter.

- They are sharp and may cause injury.

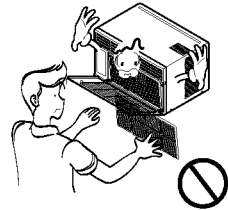

CAUTION

Installation

Install the product so that the noise or hot wind from the outdoor unit may not cause any damage to the neighbors.

- Otherwise, it may cause dispute with the neighbors.

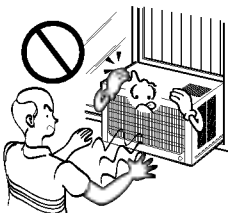

Keep level parallel in installing the product.

- Otherwise, it may cause vibration or water leakage.

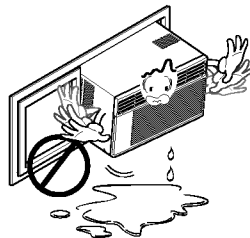

■ Operation

Do not put a pet or house plant where it will be exposed to direct air flow.

- It may cause injury.

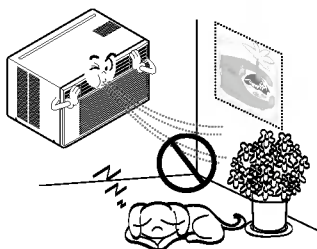

Do not block the inlet or outlet of air flow.

- It may cause product failure.

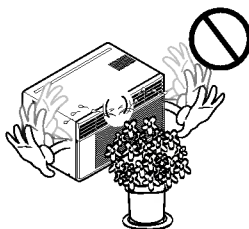

Use a soft cloth to clean. Do not use wax, thinner, or a strong detergent.

- The appearance of the air conditioner may deteriorate, change color, or develop surface flaws.

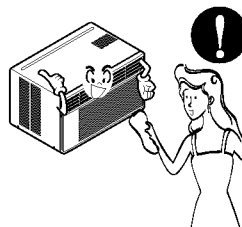

Do not step on the indoor/outdoor unit and do not put anything on it.

- It may cause an injury through dropping of the unit or falling down.

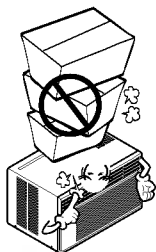

Always insert the filter securely. Clean it every two weeks.

- Operation without filters will cause failure.

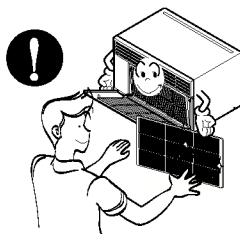

Do not drink water drained from air conditioner.

- It contains contaminants and will make you sick.

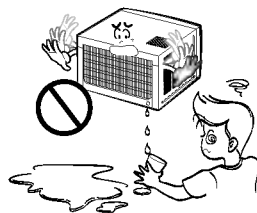

Be cautious not to touch the sharp edges when installing.

- It may cause injury.

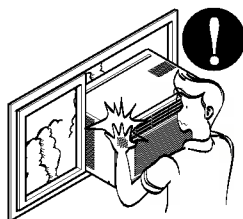

Avoid excessive cooling and perform ventilation sometimes.

- Otherwise, it may do harm to your health.

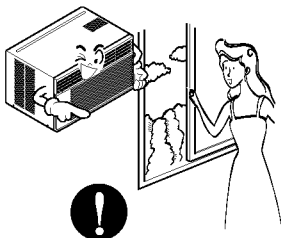

Do not insert the hands or bars through the air inlet or outlet during operation.

- Otherwise, it may cause personal injury.

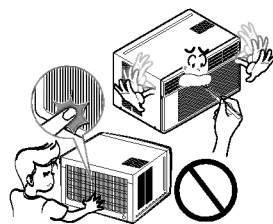

Before Operation

Preparing for Operation

1. Contact an installation specialist for installation.
2. Plug in the power plug properly.
3. Use a dedicated circuit.
4. Do not use an extension cord.
5. Do not start/stop operation by plugging/unplugging the power cord.
6. If the cord/plug is damaged, replace it with only an authorized replacement part.

Usage

1. Being exposed to direct airflow for an extended period of time could be hazardous to your health. Do not expose occupants, pets, or plants to direct airflow for extended periods of time.
2. Due to the possibility of oxygen deficiency, ventilate the room when used together with stoves or other heating devices.
3. Do not use this air conditioner for non-specified special purposes (e.g. preserving precision devices, food, pets, plants, and art objects). Such usage could damage the items.

Cleaning and Maintenance

1. Do not touch the metal parts of the unit when removing the filter. Injuries can occur when handling sharp metal edges.
2. Do not use water to clean inside the air conditioner. Exposure to water can destroy the insulation, leading to possible electric shock.
3. When cleaning the unit, first make sure that the power and breaker are turned off. The fan rotates at a very high speed during operation. There is a possibility of injury if the unit's power is accidentally triggered on while cleaning inner parts of the unit.

Service

For repair and maintenance, contact your authorized service dealer.

Introduction

Symbols Used in this Manual



This symbol alerts you to the risk of electric shock.



This symbol alerts you to hazards that could cause harm to the air conditioner.

NOTICE

This symbol indicates special notes.

Features

⚠ WARNING

This appliance should be installed in accordance with the National Electric Code.

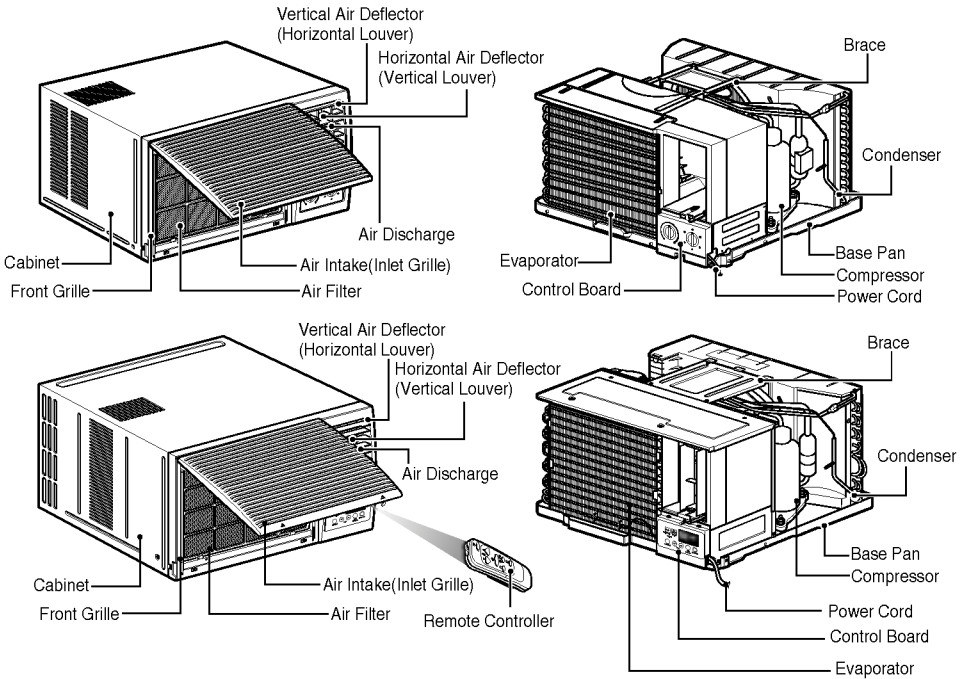

Installation

Select the Best Location

1. Measure the space for installation to assure a good fit. The air conditioner must be installed firmly into place to prevent vibration and noise.
2. Avoid exposure to direct sunlight.
3. Remove all obstacles from the rear of the unit. There must be at least 50cm (20in.) of cleared space around the rear of the unit. Obstacles restricting the airflow may reduce the cooling efficiency of the unit.
4. The unit should be installed with a slight tilt towards the outside (approx. 3°) to allow condensed water to drain. (About 10~15mm or 1/4 bubble with level)

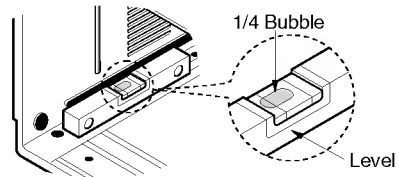
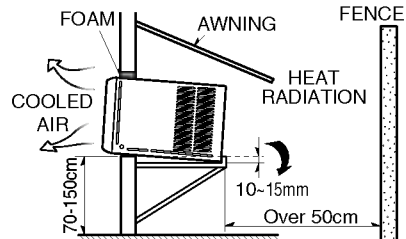

NOTICE

The external grille must be exposed outside for air discharge.

Remove the Air Conditioner From the Case

1. Remove 2 shipping screws from the back of the case.
2. Remove the 2 screws on each side of the case. Keep these for later use.
3. Slide out the air conditioner from the case by pulling the base-pan handle while bracing the case.
4. Remove the white Styrofoam shipping block from the compressor. (Applicable for some models)

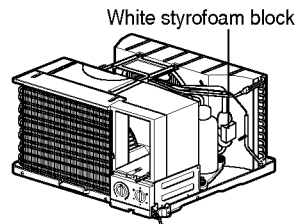
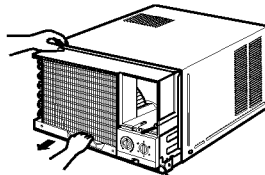
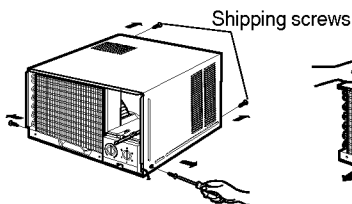

Attaching the Drain Pan (Optional)

The drain pan is used to collect condensed water.

The base-pan may overflow due to high humidity. The base-pan may also collect excess water when in reverse mode (in Reverse Cycle models only). To drain the excess water, remove the drain cap from the back of the unit and secure the drainpipe as follows:

1. Remove the drain pan located in the air discharge or on the barrier.
 2. Remove the rubber cap from the hole on the base-pan. (Not applicable to all models)
 3. Install the drain pan to the left corner of the cabinet with 2-4 screws.
 4. Connect the drain hose to the hole located on the bottom of the drain pan.
- You can purchase the drain hose or tubing locally to satisfy your particular needs. (Drain hose not included)

Installation of the Housing

Step 1

Remove the air conditioner from its packaging and slide the air conditioner out of its housing.

Step 2

Prepare the hole in the wall so that the bottom of the housing is well supported, the top has minimum clearance and the air inlet louvers have clearance as shown. Holes from the outside through to the cavity should be sealed. The housing should slope down towards the rear by about 5mm to allow water formed during operation to drain.

Step 3

Install the housing into the wall and secure. Ensure the foam seals are not damaged. Flash, seal or fill gaps around the inside and outside to provide satisfactory appearance and protection against the weather, insects and rodents.

NOTICE UNIT MAY BE SUPPORTED BY A SOLID FRAME FROM BELOW OR BY A HANGER FROM A SOLID OVERHEAD SUPPORT.

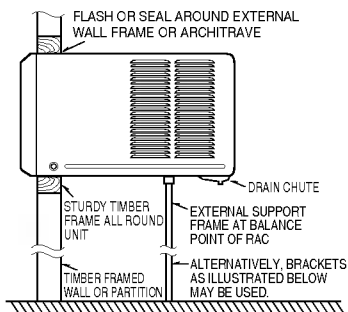

Preferred method of installation into a timber framed wall, partition or window.

Installations of the unit into the Housing

1. Slide the unit into the housing until it is firmly against the rear of the housing. Care is required to ensure the foam sealing strips on the housing remain in position.
2. Connect the air conditioner to the power and coil excess cord length beneath the air conditioner base or control box.
3. Engage the Chassis Lock into the bottom housing rail and secure to the base with the screw provided.
4. Remove the front panel from its carton and plastic bag and fit as per the Operating Instruction.
5. Switch unit on. Check for operation of the unit and check for vibration in the installation.
6. Fit the drain chute to the housing and run a drain line to a suitable location if required.

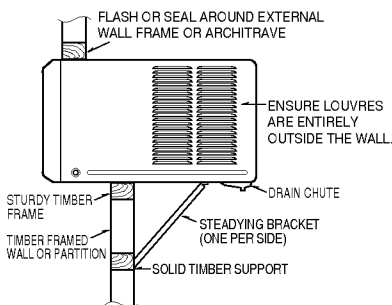

Alternative method of installation if external support cannot be provided.

Installations of the unit into the wall

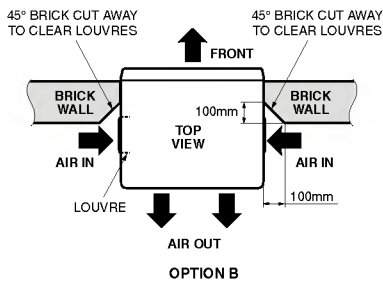
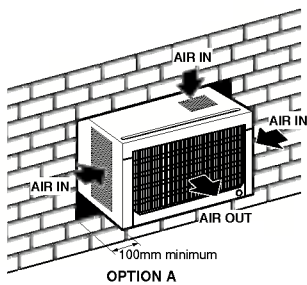

Install the Air Conditioner in the Case

- Slide the air conditioner into the case. Reinstall the 2 screws removed earlier on each side of the case.

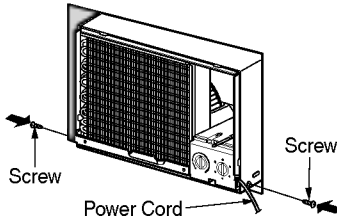

⚠ CAUTION

The power cord must be connected to an independent circuit.
The green wire must be grounded.

- Stuff the foam between the top of the unit and the wall to prevent air and insects from getting into the room.

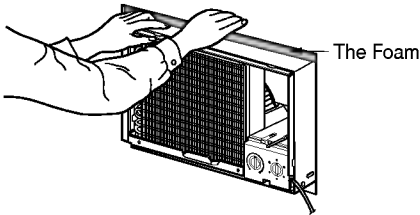

- Before installing the front grille, pull out the vent control lever located above the unit control knobs, as shown. (for some models)

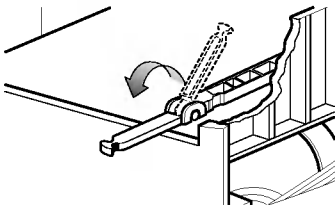

- Attach the front grille to the case by inserting the tabs on the grille into the slots on the front of the case. Push the grille in until it snaps into place. When you detach the front grille from the case, push the grille to your right side and pull it toward you.

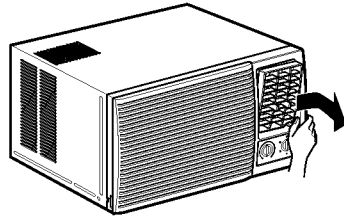
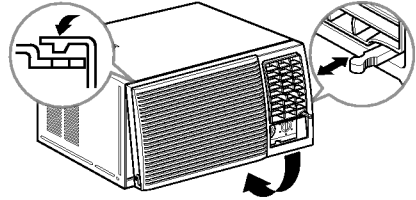

- Lift the inlet grill and secure the front grille with a screw(L:10mm). Lower the inlet grille into place. (for some models)

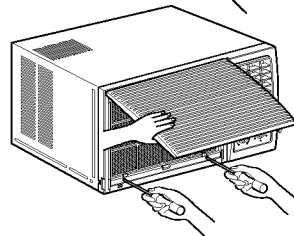
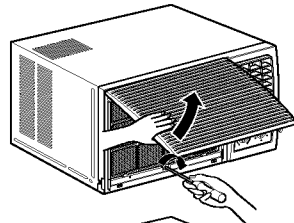
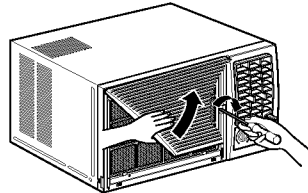

How to Use the Reversible Inlet Grille(For Some Models)

The grille is designed to clean the filter both upward and downward.

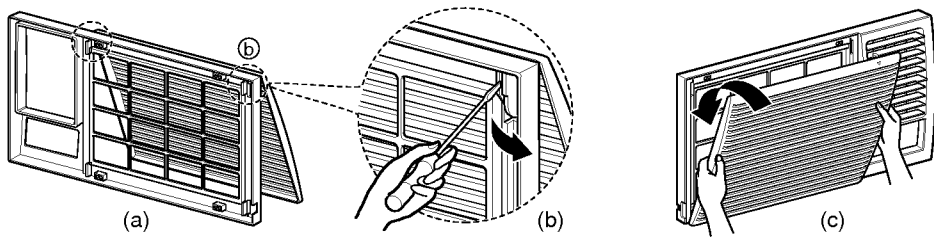

A. Before attaching the front grille to the cabinet, if you want to pull out the filter upward;

1. Open the inlet grille slightly (a).
2. Turn inside out the front grille (a).
3. Disassemble the inlet grille from the front grille with separating the hinged part by inserting a straight type screw-driver tip (b).
4. Then, rotate the inlet grille 180 degrees and insert the hooks into bottom holes of the front grille.
5. Insert the filter and attach the front grille to the cabinet.

B. If you want to pull out the filter downward;

The grille is already designed that way.

Circuit Breaker Installation and Parts for Installation

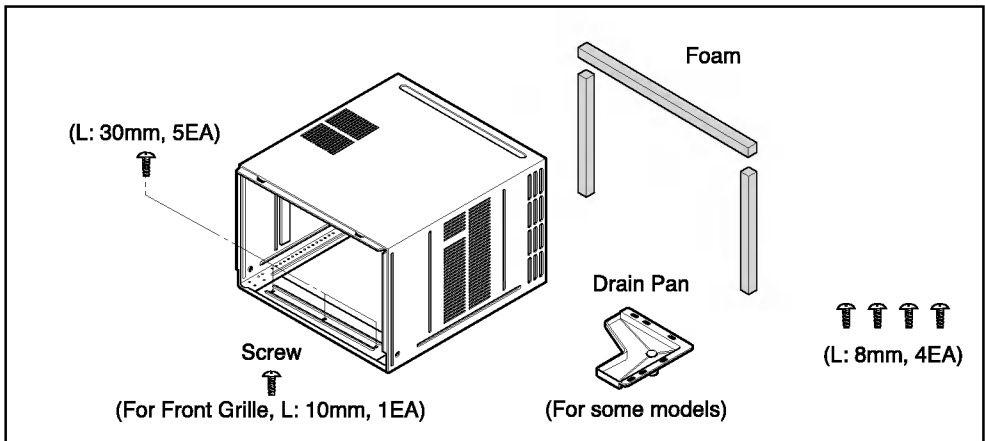
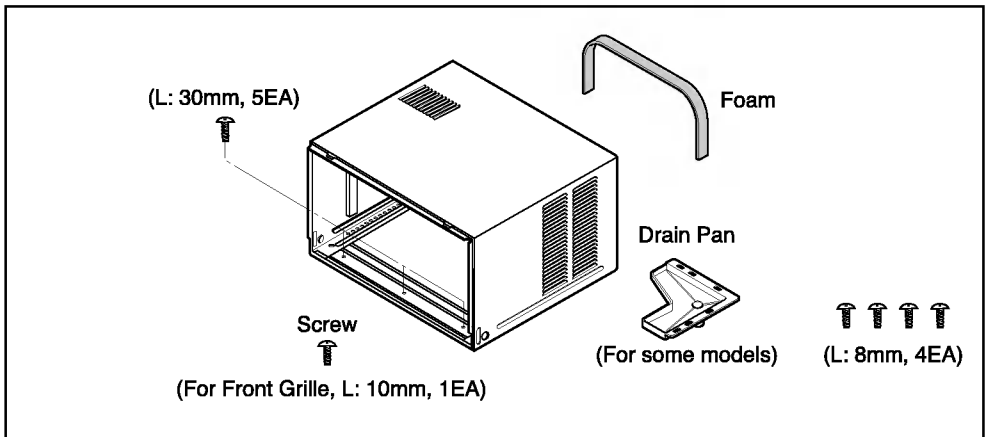
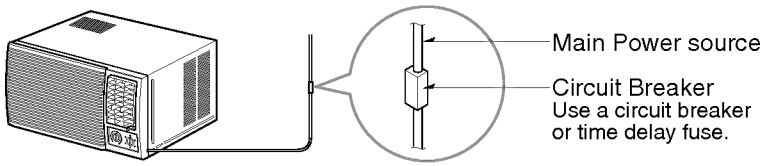

- Read thoroughly and follow all directions provided.
- A circuit breaker must be installed between the power source and the unit if the plug is not used (see illustration below).



Operating Instructions

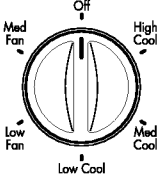

Controls

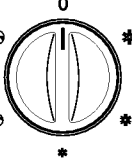
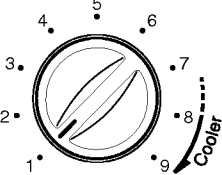
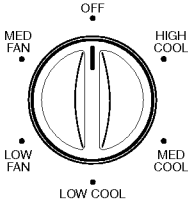
The controls will look like one of the following.

Thermostat	Operation
	
	
	
<p>Thermostat will automatically control the temperature of the room. Select higher number for lower room temperature. The temperature is selected by turning the knob to the desired position. The 5 or 6 position is a normal setting for average conditions.</p>	<p>OFF, No (0): Turns the air conditioner off. MED FAN (⊕): Permits the medium fan speed operation without cooling. LOW FAN (⊙): Permits the low fan speed operation without cooling. HIGH COOL (*): Permits cooling with the high fan speed operation. MED COOL (*): Permits cooling with the medium fan speed operation. LOW COOL (*): Permits cooling with the low fan speed operation.</p>

Controls

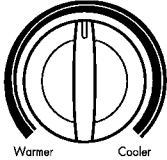
The controls will look like one of the following.

Thermostat	Operation
 <p>Warmer Cooler</p>	
<p>■ THERMOSTAT</p> <p>Turn the thermostat control to the desired setting. The control position is a normal setting for average conditions. You can change this setting, if necessary, in accordance with your temperature preference.</p> <p>The thermostat automatically controls cooling or heating, but the fan runs continuously whenever the air conditioner is in operation. If the room is too warm, turn the thermostat control clockwise. If the room is too cool, turn the thermostat control counterclockwise.</p>	<p>■ OPERATION</p> <p>OFF (○) : Turns the air conditioner off.</p> <p>LOW FAN (⊗) : Permits the low fan speed operation without cooling (heating).</p> <p>LOW COOL (*) : Permits cooling with the low fan speed operation.</p> <p>HIGH COOL (⊛) : Permits cooling with the high fan speed operation.</p> <p>LOW HEAT (⊙) : Permits heating with the low fan speed operation.</p> <p>HIGH HEAT (⊚) : Permits heating with the high fan speed operation.</p>

■ HEATER (⊙) LAMP

When the unit sets heating operation condition, the green lamp is lighted.

When the frost settles on the heat exchanger of the outside, defrosting is made automatically and the green lamp is turned off.

The unit may give a "hiss" and the fan motor stops for 1 to 10 minutes.

This should not be regarded as a problem.

After defrosting, the heating operation begins again.



■ COOLING DESCRIPTIONS

For Normal Cooling - Select **High Cool** or **Med Cool** with the **Operation** knob at the midpoint of **Thermostat** knob.

For Maximum Cooling - Select **High Cool** with the **Operation** knob at the highest number available on your **Thermostat** knob.

For Quieter & Nighttime Cooling - Select **Low Cool** with the **Operation knob** at the midpoint of **Thermostat** knob.

■ AUTO SWING (available in some models)

ON (Δ , SI) : Air swing is operated while OPERATION knob is set to the COOL position.

OFF(↑ , NO) : Stops the operation of air swing.

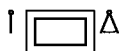
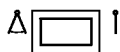

▲ CAUTION

- When the air conditioner has been performed its cooling operation and is turned off or set to the fan position, wait at least 3 minutes before resetting to the cooling operation again.

Remote Control

The remote control and control panel will look like one of the following pictures.

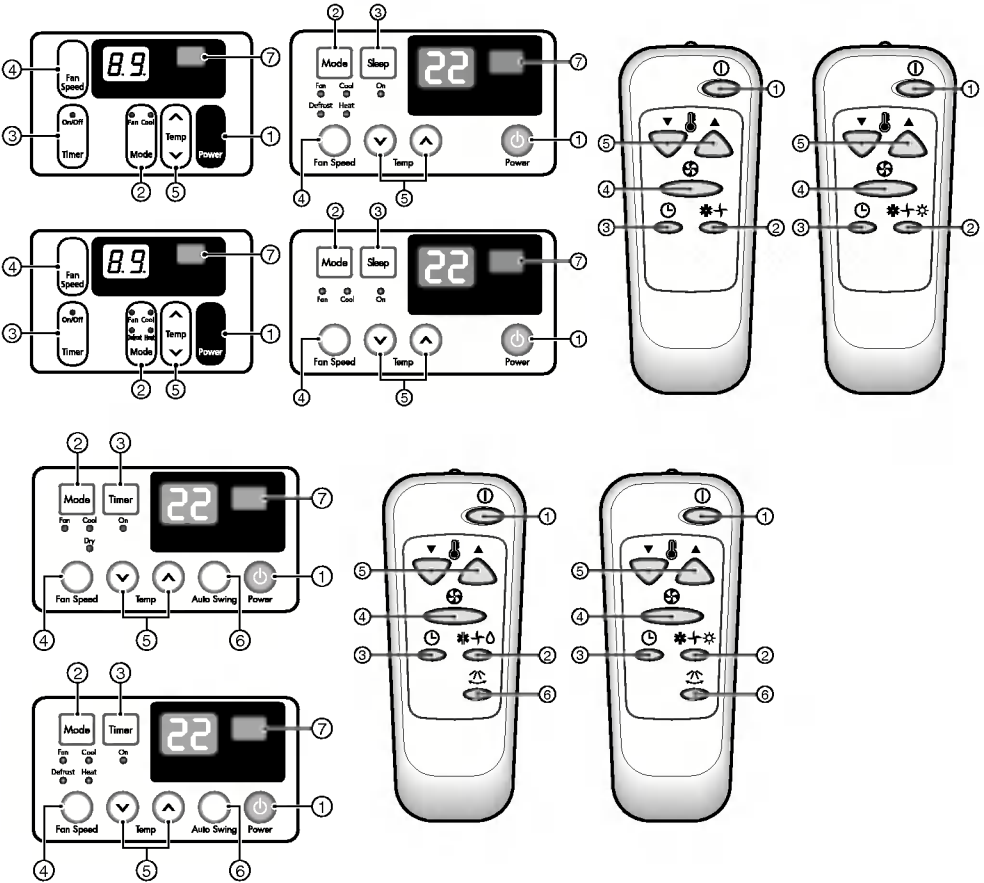

1. POWER

Operation starts when this button is pressed and stops when you press the button again.

2. OPERATION MODE SELECTOR

Heating function is only available in some models.

Select cooling mode to cool the room.

Select heating mode to heat the room.

Select fan mode for basic ventilating fan operation.

3. ON/OFF TIMER

The timer can be set to start and stop the unit in hourly increments (up to 12 hours).

Temperature increases only by 2°C and no longer increase thereafter.

4. FAN SPEED SELECTOR

For increased power while cooling or heating, select a higher fan speed.

Cooling Model: 3 steps{High[F3] → Low[F1] → Med[F2]}

Heating Model: 2 steps{High[F2] → Low[F1]}

5. TEMPERATURE CONTROL

The thermostat monitors room temperature to maintain the desired temperature.

The thermostat can be set between 16°C-30°C (61°F-81°F).

The unit takes an average of 30 minutes to adjust the room temperature by 1°C (1.8°F).

6. AUTO SWING BUTTON (available in some models)

Allows the unit to automatically swing its louvers left and right during operation. If the option is de-selected, the louvers will stop in their last position and orient the airflow in the corresponding direction.

7. REMOTE SENSOR

Auto Restart

In case the power comes on again after a power failure, Auto Restarting Operation is the function to operate procedures automatically to the previous operating conditions.

Inserting the Remote Control Batteries

1. Push out the cover on the back of the remote control with your thumb
2. Pay attention to polarity and insert two new AAA 1.5V batteries.
3. Reattach the cover.

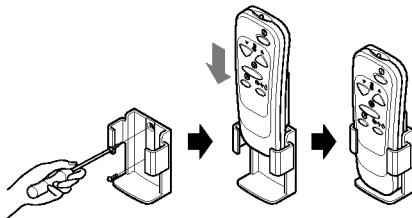

NOTICE

Do not use rechargeable batteries. Make sure that both batteries are new.

- In order to prevent discharge, remove the batteries from the remote control if the air conditioner is not going to be used for an extended period of time

Keep the remote control away from extremely hot or humid places.

To maintain optimal operation of the remote control, the remote sensor should not be exposed to direct sunlight.

- The remote control can be mounted on a wall using the mountable holder.

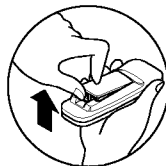

Ventilation

The ventilation lever must be in the CLOSE position in order to maintain the best cooling conditions. When fresh air is necessary in the room, set the ventilation lever to the OPEN position. The damper is opened and room air is drawn out.

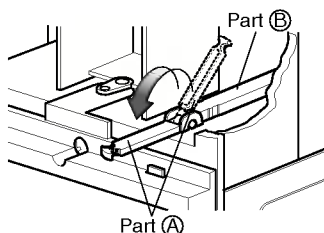
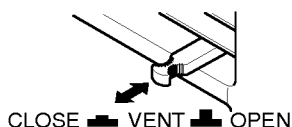

NOTICE

Before using the ventilation feature, position the lever, as shown. First, pull down part (A) to horizontal line with part (B).

Air Direction

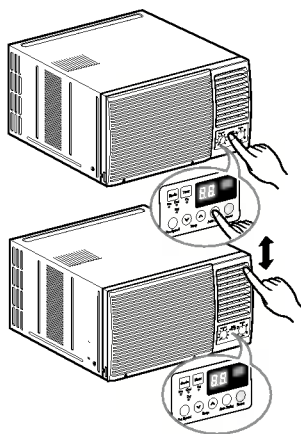

The direction of air can be controlled wherever you want to cool by adjusting the horizontal louver and the vertical louver.

• HORIZONTAL AIR-DIRECTION CONTROL

To control horizontal direction of air flow, set to the ON position the air-swing switch and the air flow will be swept horizontally by the automatic air-swing system.

If you want to stop the air flow from moving, switch off the air swing switch at the desired position of the vane.

• VERTICAL AIR-DIRECTION CONTROL

The vertical air direction is adjusted by moving the horizontal louver.

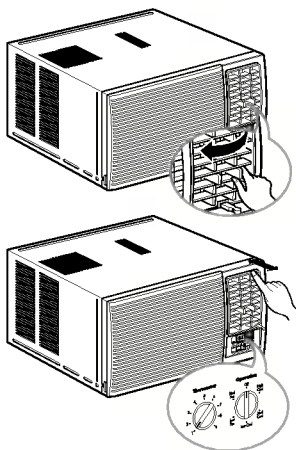

The direction of air can be controlled wherever you want to cool by adjusting the horizontal louver and the vertical louver.

• HORIZONTAL AIR-DIRECTION CONTROL

The horizontal air direction is adjusted by rotating the vertical louver right or left.

• VERTICAL AIR-DIRECTION CONTROL

The vertical air direction is adjusted by rotating the horizontal louver forward or backward.

How to Attach Drain Pan(Optional)

The air conditioner employs a proper drain method whereby the condensed water (moisture removed from the air) is drained to the outside.

In very humid weather, (and for reverse cycle models in the reverse mode) excessive condensate water removed from the air may cause some water to collect. To remove this excess water you can install the drain pan as detailed below.

1. Take the drain pan which is located in the air discharge.
2. Remove the hole rubber from the base-pan (for some models).
3. Install the drain pan to the right corner of the cabinet with 4 (or 2) screws.
4. Connect the drain hose of 3/5" inside diameter to the outlet located at the bottom of the drain pan. You can purchase the drain hose or tubing locally to satisfy your particular needs. (Drain hose is not supplied).

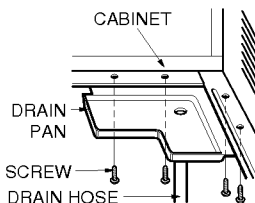

How to Connect a Drain Hose

A drain hole is provided at the rear of the air conditioner unit.

Select a drain method according to the following.

1. Remove the hole rubber from the base-pan. (for some models)
2. Connect a drain hose of $\frac{9}{16}$ " inside diameter to the drain pipe as shown in Fig. 1.
3. Or connect a pipe elbow of $\frac{9}{16}$ " inside diameter to the drain pipe, then connect a drain hose of $\frac{9}{16}$ " inside diameter to the pipe elbow as shown in Fig. 2.

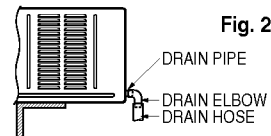
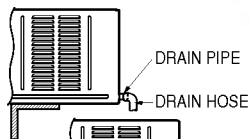

Maintenance and Service

TURN THE AIR CONDITIONER OFF AND REMOVE THE PLUG FROM THE POWER OUTLET.

Air Filter Cleaning

The air filter should be checked at least twice a month to see if cleaning is necessary. Trapped particles in the filter will build up and block the airflow. This reduces the cooling capacity and also causes an accumulation of frost on the cooling coils.

- 1 Open the inlet grille upward by pulling out the bottom of the inlet grille.(a)
In another case, you can open the inlet grille downward by pulling out the top of the inlet grille.(b)
2. Remove the air filter from the front grille assembly by pulling the air filter up or down slightly.
3. Wash the filter using lukewarm water below 40°C (104°F).(c)
4. Gently shake the excess water from the filter completely. Replace the filter.

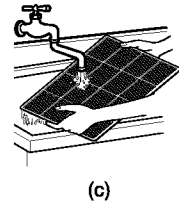
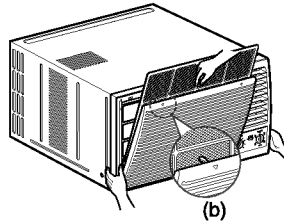
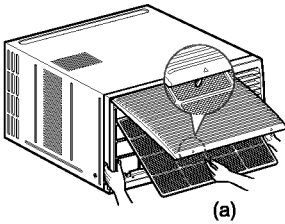

NOTICE

Mark Δ of inlet grille means opening direction.

How to Attach Front Grille to Cabinet

1. Pull down front grille from the cabinet top.
2. Push front grille's tips toward the cabinet in order to insert front grille's tabs into the cabinet.
3. Open the inlet grille.
4. Tighten the screw through the front grille into the plate of the evaporator or base pan.
5. Close inlet grille.

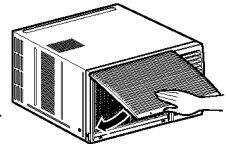
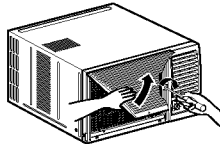
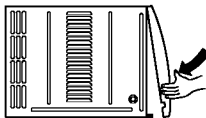
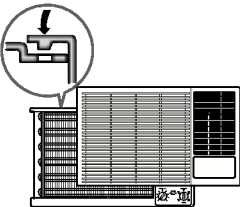

Troubleshooting

Normal Operating

- You may hear a pinging noise caused by water being picked up and thrown against the condenser on rainy days or when the humidity is high. This design feature helps remove moisture and improve efficiency.
- You may hear the thermostat click when the compressor cycles on and off.
- Water will collect in the base pan during high humidity or on rainy days. The water may overflow and drip from the outdoor side of the unit.
- The fan may run even when the compressor does not.

Abnormal Operation

Problem	Possible Causes	What To Do
Air conditioner does not start	■ The air conditioner is unplugged.	• Make sure the air conditioner plug is pushed completely into the outlet.
	■ The fuse is blown/circuit breaker is tripped.	• Check the house fuse/circuit breaker box and replace the fuse or reset the breaker.
	■ Power failure.	• If power failure occurs, turn the mode control to OFF . When power is restored, wait 3 minutes to restart the air conditioner to prevent tripping of the compressor overload.
Air conditioner does not cool as it should	■ Airflow is restricted.	• Make sure there are no curtains, blinds, or furniture blocking the front of the air conditioner.
	■ The THERMOSTAT may not be set high enough.	• Turn the knob to a higher number. The highest setting provides maximum cooling.
	■ TEMP Control set to a higher number.	• Set the TEMP Control to a lower number.
	■ The air filter is dirty.	• Clean the filter at least every 2 weeks. See the operating instructions section.
	■ The room may have been hot.	• When the air conditioner is first turned on you need to allow time for the room to cool down.
	■ Cold air is escaping.	• Check for open furnace floor registers and cold air returns. • Set the air conditioner's vent to the closed position.
Air conditioner freezing up	■ Cooling coils have iced up.	• See Air Conditioner Freezing Up below.
	■ Ice blocks the air flow and stops the air conditioner from cooling the room.	• Set the mode control at Med Fan or High Cool with the thermostat at 1 or 2. • Set the mode control at High Fan or High Cool with the high temperature.



LG Electronics Inc.