



HI-FI MICRO CD COMPONENT SYSTEM OWNER'S MANUAL

**MODELS: FFH-192A, FE-192E
FFH-195A, FE-195E
FFH-196A, FE-196E**



**Please read this manual carefully before operating
your set.**

Retain it for future reference.

**Designs and specifications are subject to change
without notice for improvement.**



Precautions

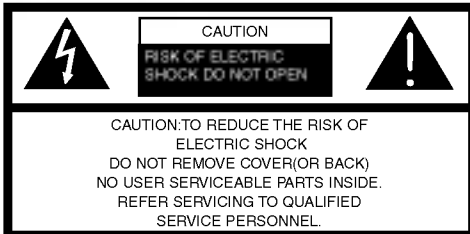

Explanation Graphical Symbols:



The lightning flash with arrowhead symbol, within an equilateral triangle is intended to alert the user to the presence of uninsulated dangerous voltage within the product's enclosure that may be of sufficient magnitude to constitute a risk of electric shock to persons.



The exclamation point within an equilateral triangle is intended to alert the user to the presence of important operating and maintenance (servicing) instructions in the literature accompanying the appliance.

WARNING:

TO REDUCE THE RISK OF FIRE OF ELECTRIC SHOCK, DO NOT EXPOSE THIS APPLIANCE TO RAIN OR MOISTURE. To avoid electrical shock, do not open the cabinet, Refer servicing to qualified personnel only.

CAUTION

Use of controls or adjustments or performance of procedures other than those specified herein may result in hazardous radiation exposure.

The apparatus shall not be exposed to dripping or splashing and that no objects filled with liquids, such as vases, shall be placed on the apparatus.

(FOR THE CUSTOMERS IN EUROPE)

If this product is marked with the CE-symbol, it means which is conforms to EMC regulation 89/336/EEC.

Laser component in this product is capable of emitting radiation exceeding the limit for Class 1.

CAUTION: INVISIBLE LASER RADIATION WHEN OPEN AND INTERLOCKS DEFEATED. AVOID EXPOSURE TO BEAM.

WARNING: OSYNLIG LASERSTRÅLNING NÄR DENNA DEL ÄR ÖPPNAD STRÅLEN ÄR FARLIG.

Attention: Quand l'appareil est ouvert, ne pas s'exposer aux radiations invisibles du faisceau laser.

This label is located on the interior.

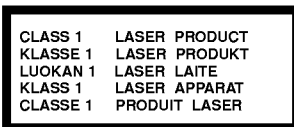

This Compact Disc player is classified as a CLASS 1 LASER product. The CLASS 1 LASER PRODUCT label is located on the exterior.

(FOR CUSTOMERS IN CANADA)

CAUTION: TO PREVENT ELECTRIC SHOCK, DO NOT USE THIS (POLARIZED) PLUG WITH AN EXTENSION CORD, RECEPTACLE, OR OTHER OUTLET UNLESS THE BLADES CAN BE FULLY INSERTED TO PREVENT BLADE EXPOSURE.

This class B digital apparatus meets all requirements of the Canadian Interference-Causing Equipment Regulations.

Warning:

Do not install this equipment in a confined space such as a book case or similar unit.

WARNING:

SHOCK HAZARD - DO NOT OPEN

MISE EN GARDE:

Pour éviter les chocs électriques, n'utilisez pas cette fiche (polarisée) avec une rallonge, un réceptacle ou une autre prise si vous ne pouvez pas y insérer les broches à fond. **MISE EN GARDE**

Cet appareil numérique de la classe B respecte toutes les exigences

de Règlement sur le matériel brouilleur de Canada.

AVERTISSEMENT

RISQUE DE CHOC ELECTRIQUE NE PAS OUVRIR
(FOR CUSTOMERS IN THE UNITED STATES OF AMERICA)

NOTE:

Note to CATV system Installer:

This reminder is provided to call the CATV system installer's attention to Article 820-40 of the NEC that provides guidelines for proper grounding and, in particular, specifies that the cable ground shall be connected to the grounding system of the building, as close to the point of cable entry as practical.

The interference potential to the device.

This equipment generates and uses radio frequency energy and if not installed and used properly, that is in strict accordance with the manufacturer's instructions, may cause interference to radio and television reception. It has been type tested and found to comply with the limits for a Class B computing device in accordance with the specifications in subparts J of Part 15 of FCC Rules, which are designed to provide reasonable protection against such interference in a residential installation. However, there is no guarantee that interference will not occur in a particular installation. If this equipment does cause interference to radio or television reception, which can be determined by turning the equipment off and on, the user is encouraged to try to correct the interference by one of more of the following measures:

- Reposition or relocate the receiving antenna.
- Increase the separation between the equipment and receiver.
- Connect the equipment into an outlet on a circuit different from that to which the receiver is connected.
- Consult the dealer or an experienced radio/TV technician for help.

(FOR CUSTOMERS IN THE UNITED KINGDOM)

WIRING INSTRUCTIONS

This appliance is supplied with a BS1363 approved 3 amp fused mains plug. When replacing the fuse always use a 3 amp BS1362 approved type. Never use this plug with the fuse cover omitted. To obtain a replacement fuse cover contact your supplying dealer or "LG ELECTRONICS U.K.LTD"

If the mains sockets in your home differ, or are not suitable for the type of plug supplied, then the plug should be removed and a suitable type fitted. Please refer to the wiring instructions below:

Warning: The mains plug severed from the mains lead of this appliance must be destroyed. A mains plug with bared wires is hazardous if engaged in a mains output line socket.

IMPORTANT

The wires in this mains lead are coloured in accordance with the following codes:

Blue	:	Neutral
Brown	:	Live

As the colour of the wires in the mains lead of this appliance may not correspond with the coloured markings identifying the terminals in your plug, proceed as follows:

The wire which is coloured blue must be connected to the terminal which is marked with the letter N or coloured black.

The wire which is coloured brown must be connected to the terminal which is marked with the letter L or coloured red.

If a 13 amp BS1363 plug or any other type of plug is used, 3 amp BS1362 approved fuse must be fitted either in the plug or at the distribution board.

Warning:

Do not connect either wire to the earth pin, marked with the letter E or with the earth symbol  or coloured green or green and yellow.

Table of Contents

INTRODUCTION

Precautions	2
Table of Contents	3
Before Use	4
Safety Precautions	4
Notes on Discs	4
Notes on Remote Control	4
Front Panel/ Rear Panel	5
Remote Control	6
Display Window	6
Connections	7
Speaker System Connection	7
Antenna (Aerial) Connections	7

BEFORE OPERATION

Setting the Voltage (OPTIONAL)	8
Setting the CLOCK	8
Sleep Function	8
Timer Function	9
Audio Adjustment	10
Volume Adjustment	10
Sound Quality Adjustment	10
MUTE	10
SURROUND	10
XDSS (Extreme Dynamic Sound System)	10
Auxiliary Function	10



OPERATION

Presetting the radio stations	11
Listening to the radio	11
Tape Playback	12
Basic Playback	12
To Stop Play	12
Tape Counter Reset	12
To Play Fast Rewind or Fast Forward	12
Recording	12
Basic Setting	12
Recording from Radio, CD or Auxiliary source	12
CD to Tape Synchronized Recording	12
CD Playback	13
Basic Playback	13
To Pause Play	13
To Stop Play	13
To Skipping the Track	13
To Play Fast Rewind or Fast Forward	13
To Repeat Play	13
To Program Play	14

REFERENCE

Troubleshooting	14
Specification	15

About the symbols for instructions

-  Indicates hazards likely to cause harm to the unit itself or other material damage.
-  Indicates special operating features of this unit.
-  Indicates tips and hints for making the task easier.

Before Use

Safety Precautions

Handling the unit

When shipping the unit

The original shipping carton and packing materials come in handy. For maximum protection, re-pack the unit as it was originally packed at the factory.

To keep the surface clean

Do not use volatile liquids, such as insecticide spray, near the unit. Do not leave rubber or plastic products in contact with the unit for a long period of time. They will leave marks on the surface.

Cleaning the unit

To clean the cabinet

Use a soft, dry cloth. If the surfaces are extremely dirty, use a soft cloth lightly moistened with a mild detergent solution. Do not use strong solvents, such as alcohol, benzene, or thinner, as these might damage the surface of the unit.

Notes on Discs

Handling discs

Do not touch the playback side of the disc.
Hold the disc by the edges so that fingerprints will not get on the surface.
Do not stick paper or tape on the disc.

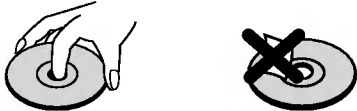

Storing discs

After playing, store the disc in its case.
Do not expose the disc to direct sunlight or sources of heat, or leave it in a parked car exposed to direct sunlight, as there may be a considerable temperature increase inside the car.

Cleaning discs

Fingerprints and dust on the disc can cause poor picture quality and sound distortion. Before playing, clean the disc with a clean cloth. Wipe the disc from the center out.



Do not use strong solvents such as alcohol, benzene, thinner, commercially available cleaners, or anti-static spray intended for analog records.

Notes on Remote Control

Remote Control Operation Range

Point the remote control at the remote sensor and press the buttons.

- **Distance:** About 23 ft (7 m) from the front of the remote sensor.
- **Angle:** About 30° in each direction of the front of the remote sensor.

Remote control battery installation

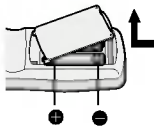

Detach the battery cover on the rear of the remote control, and insert two R03 (size AAA) batteries with + and - aligned correctly.

Caution

Do not mix old and new batteries. Never mix different types of batteries (standard, alkaline, etc.).

Front Panel/ Rear Panel

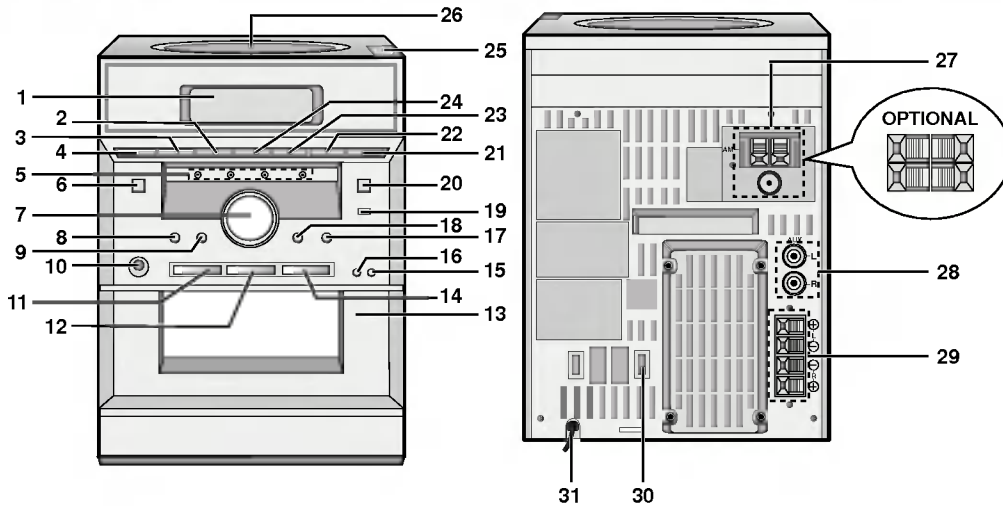

- | | |
|---|--|
| <ol style="list-style-type: none"> 1. DISPLAY 2. • BACKWARD PLAY (◀) button : OPTIONAL • PRESET (-) button 3. • PLAY MODE button : OPTIONAL • COUNTER RESET button : OPTIONAL 4. RECORD/ RECORD PAUSE (●REC/) button 5. TUNER/ CD/ TAPE/ AUX indicators 6. POWER (⏻STANDBY/ON) button 7. VOLUME (-)/(+) knob 8. CD SYNC. button 9. PROG./ MEMORY button 10. HEADPHONE SOCKET (🎧): ∅3.5mm 11. SURROUND button 12. EQUALIZER (EQ) button 13. ▲ PUSH EJECT position -DECK 14. XDSS button 15. TIMER button 16. CLOCK button 17. MODE/RIF button 18. • SET (CLOCK/ TIMER) button • COUNTER RESET button (COUNTER) : OPTIONAL • CD PAUSE (CD) button | <ol style="list-style-type: none"> 19. AM/ FM SELECT (BAND) button 20. FUNCTION SELECT (FUNCTION) button (TUNER/ CD/ TAPE/ AUX) 21. • TUNING (+) button - TUNER • SKIP (▶▶) button - CD • SEARCH (+) button - CD • FAST FORWARD PLAY (▶▶) button -TAPE/ CD 22. • TUNING (-) button - TUNER • SKIP (◀◀) button -CD • SEARCH (-) button -CD • FAST REWIND PLAY (◀◀) button -TAPE/ CD 23. • FORWARD PLAY (▶) button • PRESET (+) button 24. • STOP (■) button • CLEAR button 25. CD OPEN(▲) button 26. CD DOOR 27. ANTENNA TERMINAL 28. AUXILIARY INPUT SOCKET 29. SPEAKER TERMINAL 30. VOLTAGE SELECT SWITCH : OPTIONAL 31. POWER CORD |
|---|--|

INTRODUCTION

Remote Control

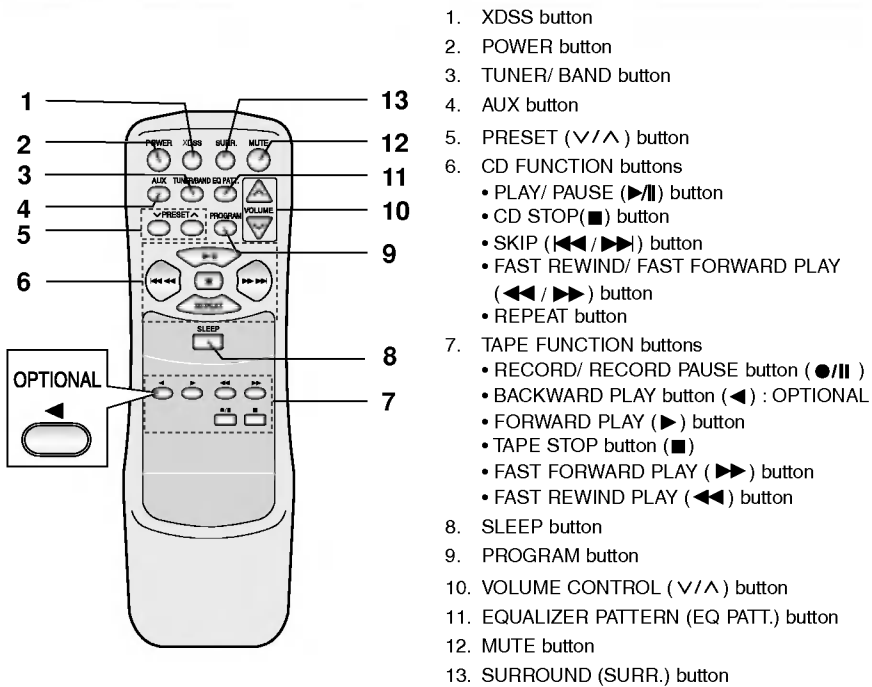

Display Window

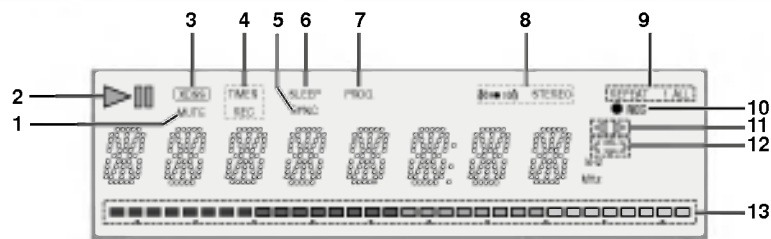

Connections

Speaker System Connection

Connect the speakers using the supplied speaker cords by matching the colors of the terminals and those of the cords. To obtain the best possible surround sound, adjust the speaker parameters (distance, level, etc.).

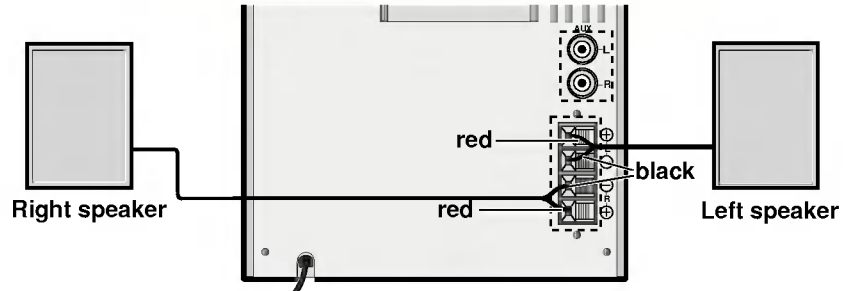

Notes

- Be sure to match the speaker cord to the appropriate terminal on the components: + to + and – to –. If the cords are reversed, the sound will be distorted and will lack base.
- If you use front speakers with low maximum input rating, adjust the volume carefully to avoid excessive output on the speakers.
- Do not disassemble the front cover of supplied speaker.

Antenna (Aerial) Connections

Connect the supplied FM/AM antennas for listening to the radio.

- Connect the AM loop antenna to the AM antenna connector.
- Connect the FM wire antenna (or FM "T" antenna) to the FM 75Ω/300Ω coaxial connector.

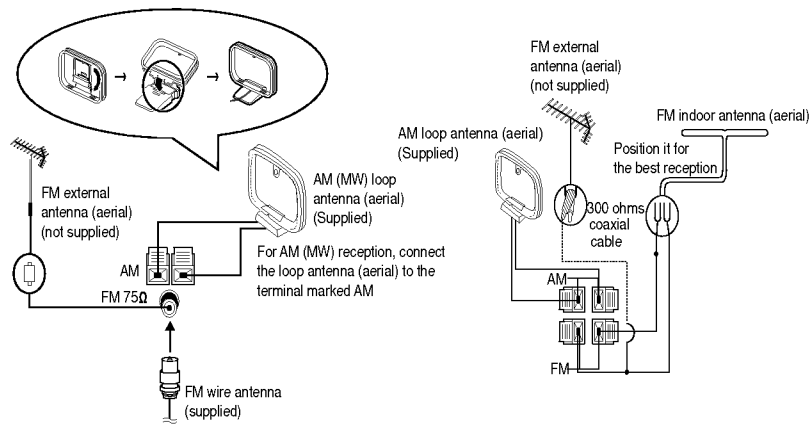

Notes

- To prevent noise pickup, keep the AM loop antenna away from the unit and other components.
- Be sure to fully extend the FM wire antenna.
- After connecting the FM wire antenna, keep it as horizontal as possible.

Setting the Voltage (OPTIONAL)

If your set is equipped with a voltage selector at the back side, be sure to set it to your local power supplied before connecting the AC power cord.

Setting the CLOCK

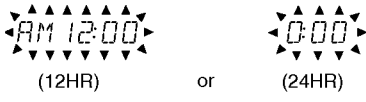
- 1** Press **CLOCK**.
(If the clock requires setting, press and hold **CLOCK** for more than 2 seconds.)
- The hours begin to flash.
- 2** Select a 24 hour cycle or 12 hour cycle by pressing **PRESET (-)/(+)**.

(12HR) or (24HR)
- 3** Press **SET** to confirm the selected hour cycle.
- 4** Use **PRESET (-)/(+)** to set the correct hours.
- 5** Press **SET**.
- 6** Use **PRESET (-)/(+)** to set the correct minutes.
- 7** Press **SET** and the correct time is shown on the display.
- 8** Press **CLOCK** at any time to display the time for about 3 seconds.

Sleep Function

When the sleep timer is used, the power is automatically turned off after the specified time has elapsed.

- 1** To specify the time delay before the power is turned off, press **SLEEP**.
In the display window you can see **SLEEP 90** for about 5 seconds. This means that the system turns off automatically after 90 minutes.
Each time the button is pressed the time interval before it turns off is reduced by 10 minutes. i.e. 80...70... etc.
Select the desired time to turn off.
- 2** To check the remaining time until the power is turned off.
While the sleep function is active press **SLEEP** briefly. The time remaining until it turns off is displayed for about 5 seconds.

Note

If you press **SLEEP** while the sleep time is displayed, the **SLEEP** time is reset.

To cancel the sleep timer mode

If you wish to stop the function, press the **SLEEP** button repeatedly until 10 appears, and then press **SLEEP** once again while 10 is displayed.

Timer Function

With the TIMER function you can have the radio reception and recording, CD play, tape play or auxiliary source play and recording turned on and off at the time desired.

- 1** Press **CLOCK** to check the current time.
- 2** Press **"TIMER"** to enter the timer setting mode.
(If you want to correct the previous memorized TIMER setting, press and hold the **"TIMER"** button more than 2 seconds.)
The previous memorized timer on time and **"TIMER"** appears in the display. Each function :
TUNER-CD-TAPE flashes in the display window in turn.
- 3** Press **SET** when the desired function is flashing.
- 4** If you select the TUNER:
PLAY and REC flash in the display window alternately for about 3 seconds. Press **SET** to confirm the desired operating mode.
REC: TUNER recording and play
PLAY: TUNER play only
 - If you have selected the CD or TAPE, ignore step 4.
- 5** When you have selected the TUNER;
Select the previous memorized preset number with **PRESET (-)/(+)** and press **SET**. The hour **"ON"** display flashes.
 - If you have selected the CD or TAPE, ignore step 5.
- 6** Set the hour to switch on by pressing **PRESET (-)/(+)**.
- 7** Press **SET** to confirm the hour to switch on.
The minute **"ON"** display flashes.
- 8** Set the minute to switch on by pressing **PRESET (-)/(+)**.
- 9** Press **SET** to confirm the minute to switch on.
The hour **"OFF"** now flashes in the display.
- 10** Set the hour to switch off by pressing **PRESET (-)/(+)**.
- 11** Press **SET**.
- 12** Set the minute to switch off by pressing **PRESET (-)/(+)**.
- 13** Press **SET**.
- 14** Adjust the volume level by pressing **PRESET (-)/(+)**.
- 15** Press **SET**.
"TIMER" appears in the display window and the timer setting has been completed.
- 16** Switch the system off.
The selected function is automatically switched on and off at the time set.

To cancel or check the timer

Each time the **"TIMER"** button is pressed you can select the timer set or cancel. You can also check the timer setting status.
To activate or check the timer, press the **"TIMER"** button so that **"TIMER"** appears in the display window.
To cancel the TIMER, press the **"TIMER"** button so that **"TIMER"** disappears in the display window.



Audio Adjustment

Volume Adjustment

- Turn **VOLUME (-)/(+)** knob clockwise to increase the sound level, or counterclockwise to decrease it.
- Press **VOLUME CONTROL (^)** to increase the sound level, or press the **VOLUME CONTROL (v)** to decrease it on the remote control.

Sound Quality Adjustment

- **To activate stereo sound**
You can choose between 4 fixed sound impressions. Select a desired sound mode by using the **EQ.PATT (EQ: on the remote control)** button.
FLAT : linear frequency response
ROCK : more bass, more treble
POP : less bass, less treble
CLASSIC : for orchestral music
- **Headphone Socket**
Connect a stereo headphone plug (∅ 3.5mm) into the headphone jack.
The speakers are automatically disconnected when you plug in the headphones (not supplied).

MUTE

Press **MUTE** to mute your unit.
You can mute your unit in order, for example, to answer the telephone, "MUTE" indicator flashes in the display window.

SURROUND

To activate surround mode

You can choose between 3 fixed sound impressions. Select a desired surround mode by using **SURROUND**.

SURROUND 1 ON → SURROUND 2 ON → SURROUND OFF

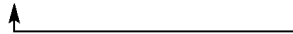

XDSS (Extreme Dynamic Sound System)

Press **XDSS** to reinforce treble, bass and surround effect.
The "XDSS ON" or "XDSS OFF" indicator lights up.
To cancel it press **XDSS** again.

Auxiliary Function

- 1** Connect an auxiliary device i.e. TV or VCR, via the rear mounted AUX phone sockets.
- 2** Press **AUX**.

Note

You can also record from the auxiliary input source, see Recording Section.

Presetting the radio stations

You can preset 30 stations for FM and AM. Before tuning, make sure that you have turned down the volume to the minimum.

- 1** Press **FUNCTION** repeatedly to appear **TUNER** indicator (or **TUNER/BAND** on the remote control).
- 2** Press **BAND** to select the **FM** or **AM** you want in the display window.
Every time you press **BAND**, **FM** and **AM** changes alternately.
- 3** Press **TUNING (-)/(+)** on the front panel until the frequency indication starts to change, then release.
Scanning stops when the unit tunes in a station.

Notes

- **Tuning in automatically**
Press **TUNING(-)/(+)** for more than 0.5 seconds.
 - **Tuning in manually**
Press **TUNING(-)/(+)** briefly and repeatedly.
- 4** Press **PROG./MEMORY**(or **PROGRAM** on the remote control).
A preset number will flash in the display window.

- 5** Press **PRESET (-)/(+)** (or **PRESET (∇/∧)** on the remote control) to select the preset number you want.
- 6** Press **PROG./MEMORY** (or **PROGRAM** on the remote control) again.
- The station is stored.
- 7** Repeat steps 3 to 6 to store other stations.

To clear all the memorized stations

Press and hold **PROG./MEMORY** on the front panel for about two seconds, "CLEAR" appears in the display window and then press **PROG./MEMORY** again, the stations are cleared.

For your reference

If all stations have already been entered, **FULL** message will appear in the display window for a moment and then a preset number will flash. To change the preset number, follow the steps 5-6.

To recall presets

Press and hold **PRESET (-)/(+)** (or **PRESET (∇/∧)** on the remote control) until the desired preset number appears or press it repeatedly.

Listening to the radio

- 1** Press **FUNCTION** repeatedly to appear **TUNER** indicator (or **TUNER/BAND** on the remote control) and then press **BAND** to select the **FM** or **AM** you want in the display window.
The last received station is tuned in.
- 2** Press **PRESET (-)/(+)** (or **PRESET (∇/∧)** on the remote control) repeatedly to select the preset station you want.
- Each time you press the button, the unit tunes in one preset station at a time.
- 3** Adjust the volume by rotating **VOLUME (-)/(+)** **KNOB** (or pressing **VOLUME (∇/∧)** on the remote control) repeatedly.

To listen to non-preset radio stations

- Use manual or automatic tuning in step 2.
- For automatic tuning, press and hold **TUNING (-)/(+)** on the front panel.

To turn off the radio

Press **POWER** to turn the unit off or select another function mode (**CD**, **TAPE** or **AUX**).

For your reference

- **If an FM program is noisy**
Press **MODE/RIF** so that "STEREO" disappears in the display window. There will be no stereo effect, but the reception will improve. Press **MODE/RIF** again to restore the stereo effect.
- **To improve reception**
Reposition the supplied antennas.

Notes

- Use **MODE/RIF** (Radio Interference Filter) function to switch to mono reception if stereo reception is distorted by noise.
- When recording the **MW(AM)** or **LW** broadcast, beat noises may occur. If it does, press **MODE/RIF** once.

Tape Playback

You can use only normal tape.

Basic Playback

- 1 Press **FUNCTION** repeatedly to appear **TAPE** indicator.
(“NO TAPE” appears in the display window.)
- 2 Open cassette deck by pushing **▲ PUSH EJECT** position.
- 3 Insert a cassette with the tape side to the bottom and then close deck.
- 4 Press **PLAY (▶)** or **◀: OPTIONAL**.

To Stop Play

Press **STOP(■)** during playback.

Tape Counter Reset

Press **COUNTER** during playback.

Playing time appears “TP - 0000” in display window.

To Play Fast Rewind or Fast Forward



After pressing **◀◀/▶▶** on the front panel or the remote control during playback, press **PLAY (▶)** at the point you want.

AUTO STOP DECK

After auto stop deck plays only front side, the unit stops automatically.

AUTO REVERSE DECK:OPTIONAL

You can select direction of the cassette you want by pressing **PLAY MODE**.

Pressing	Display	Function
Once		After the cassette plays front or reverse (backward play) side, stops automatically.
Twice		After the cassette plays front and reverse side, stops automatically.
Three times		After the cassette plays six times repeatedly front and reverse side, stops automatically.

Recording

Wind the tape to the point recording starts. (Use only normal tapes.)

Basic Setting

- 1 Press **FUNCTION** repeatedly to appear the **CD** or **TUNER** indicator.
- 2 Open the cassette deck and insert a blank cassette into the cassette compartment.
To set the recording direction :OPTIONAL
Press **PLAY MODE** repeatedly to set the recording direction.

Recording from Radio, CD or Auxiliary source

- 1 Press **●REC/III** (or **●/III** on the remote control), and then play the **CD** or **TUNER** function.
“●REC” flashes and holds the cassette in pause mode.
- 2 Press **●REC/III** or **PLAY(▶)** (or **●/III** or **PLAY(▶)** on the remote control).
The recording begins.

To pause recording

Press **●REC/III** or **●/III** again.
“●REC” flashes in display window.

To stop recording

Press **TAPE STOP(■)**.

CD to Tape Synchronized Recording

The CD synchro recording function dubs a complete CD and programmed titles automatically into a cassette.

- 1 Press **CD SYNC.** in stop mode.
“●REC” flashes and “*CD SYNC*” displays in the display window.
- 2 The synchronized recording is started automatically after about 8 seconds.

Notes

- If you wish to record from the desired track, select the desired track with **SKIP ◀◀/▶▶** before commencing CD synchro recording.
- The function change is not possible during recording.

CD Playback

Basic Playback

- 1 Press **FUNCTION** repeatedly to appear CD indicator.
If no disc is loaded then "NO DISC" is displayed.
- 2 Press **CD OPEN** (▲) and place the disc into the disc tray.

Note

To load an 8cm(3 inch) disc, put it onto the inner circle of the tray.

- 3 Press **CD OPEN** (▲) to close the disc compartment.
- 4 Press **PLAY** (▶) or **PLAY/ PAUSE** (▶||) on the remote control.

To Pause Play

Press **CD PAUSE** (CD ||) or **PLAY/ PAUSE** (▶||) on the remote control during playback.

Press this button again it to resume play.

To Stop Play

Press **STOP** (■) during playback.

To Skipping the Track

- Press the **SKIP** (▶▶) button to go to the next track.
- When the **SKIP** (◀◀) button is pressed once midway through a track, the player returns to the start of that track. When it is pressed again, a track is skipped each time the button is pressed.

To Play Fast Rewind or Fast Forward

After pressing ◀◀/▶▶ on the front panel or the remote control during playback, press **PLAY** (▶) at the point you want.

To Repeat Play

To play one track repeatedly

Press **REPEAT** once during playback.
- "REPEAT 1" appears in the display.

To play all tracks repeatedly

Press **REPEAT** again during playback.
- "REPEAT ALL" appears in the display.

To cancel repeat play

Press **REPEAT** once more during playback.
- Repeat indicator disappears.

To Program Play

You can arrange the order of the tracks on the discs and create your own program. The program can contain up to 20 tracks.

- 1 Press **PROG./MEMORY** (or **PROGRAM** on the remote control) on the stop mode.
- 2 Press **SKIP** (◀◀/▶▶) to select the track.
- 3 Press **PROG./MEMORY** (or **PROGRAM** on the remote control).
- 4 Repeat 1~3.
- 5 Press **PLAY** (▶) (or **PLAY/ PAUSE** (▶||) on the remote control).

To check program contents

Press **PROG./MEMORY** (or **PROGRAM** on the remote control) on the stop mode.
- A track and program number will be displayed.

To clear program contents

Press **PROG./MEMORY** (or **PROGRAM** on the remote control) on the stop mode. And then press **CLEAR** on the front panel or **STOP** (■) on the remote control.

To add program contents

1. Press **PROG./MEMORY** (or **PROGRAM** on the remote control) repeatedly on the program stop mode until "Track Number" blinks.
2. Repeat 2~5.

To modify program contents

1. Press the **PROG./MEMORY** (or **PROGRAM** on the remote control) to display program number you want to modify.
2. Repeat 2~4.

Troubleshooting

Check the following guide for the possible cause of a problem before contacting service.

Symptom	Cause	Correction
No power.	<ul style="list-style-type: none"> The power cord is disconnected. 	<ul style="list-style-type: none"> Plug the power cord into the wall outlet securely.
No sound.	<ul style="list-style-type: none"> The audio cables are not connected securely. 	<ul style="list-style-type: none"> Connect the audio cable into the jacks securely.
	<ul style="list-style-type: none"> The power of the external source equipment is switched off. 	<ul style="list-style-type: none"> Switch on the external source equipment.
	<ul style="list-style-type: none"> The Digital Audio Output is set to the wrong position. 	<ul style="list-style-type: none"> Set the Digital Audio Output to the correct position, then turn on the unit again by pressing POWER.
The unit does not start playback.	<ul style="list-style-type: none"> No disc is inserted. 	<ul style="list-style-type: none"> Insert a disc.
	<ul style="list-style-type: none"> An unplayable disc is inserted. 	<ul style="list-style-type: none"> Insert a playable disc.
	<ul style="list-style-type: none"> The disc is placed upside down. 	<ul style="list-style-type: none"> Place the disc with the playback side down.
	<ul style="list-style-type: none"> The disc is not placed within the guide. 	<ul style="list-style-type: none"> Place the disc on the disc tray correctly inside the guide.
	<ul style="list-style-type: none"> The disc is dirty. 	<ul style="list-style-type: none"> Clean the disc.
The remote control does not work properly.	<ul style="list-style-type: none"> The remote control is not pointed at the remote sensor of the unit. 	<ul style="list-style-type: none"> Point the remote control at the remote sensor of the unit.
	<ul style="list-style-type: none"> The remote control is too far from the unit. 	<ul style="list-style-type: none"> Operate the remote control within about 23 ft (7 m).
	<ul style="list-style-type: none"> There is an obstacle in the path of the remote control and the unit. 	<ul style="list-style-type: none"> Remove the obstacle.
	<ul style="list-style-type: none"> The batteries in the remote control are exhausted. 	<ul style="list-style-type: none"> Replace the batteries with new ones.

Specifications

SECTION		MODEL	FFH-192A	FFH-195A	FFH-196A
[General]	Power supply	Refer to the back panel of the unit.			
	Power consumption	30W	40W	50W	
	Mass	3.50kg	4.35kg	4.50kg	
	External dimensions (WxHxD)	161 X 254 X 249.5mm			
[CD]	Frequency response	40 - 18000 Hz			
	Signal-to-noise ratio	60 dB	70 dB	70 dB	
	Dynamic range	60 dB	70 dB	70 dB	
[Tuner]	FM	Tuning Range	87.5 - 108.0 MHz		
		Intermediate Frequency	10.7 MHz		
		Signal to Noise Ratio	55/50 dB	60/55 dB	60/55 dB
		Frequency Response	60 - 10000 Hz		
	AM (MW)	Tuning Range	522 - 1611 kHz OR 530 - 1610 kHz		
		Intermediate Frequency	450 kHz		
		Signal to Noise Ratio	35 dB		
		Frequency Response	100 - 1800 Hz		
[Amp]	Output Power	5W	15W	25W	
	T.H.D	0.5%	0.15%	0.15%	
	Frequency Response	60 - 20000 Hz	42 - 25000 Hz	42 - 25000 Hz	
	Signal-to-noise ratio	60 dB	80 dB	80 dB	
[TAPE]	Tape Speed	4.75cm/sec			
	Wow Flutter	0.25% (MTT -111, JIS-WTD)			
	F.F/REW Time	120sec (C-60)			
	Frequency Response	250 - 8000Hz			
	Signal to Noise Ratio	43dB			
	Channel Separation	50dB(P/B)/45dB(R/P)			
[Speakers]	Erase Ratio	55dB (MTT-5511)			
	Model name	FE-192E	FE-195E	FE-196E	
	Type	1 Way 1 Speaker	1 Way 1 Speaker	2 Way 2 Speaker	
	Impedance	4 Ω	4 Ω	6 Ω	
	Frequency Response	90 - 20000 Hz	75 - 20000 Hz	70 - 20000 Hz	
	Sound Pressure Level	86 dB/W (1m)	86 dB/W (1m)	87 dB/W (1m)	
	Rated Input Power	5 W	15 W	25 W	
	Max. Input Power	10 W	30W	50 W	
	Net Dimensions (WxHxD)	150x254x171mm	150x254x191mm	150x254x197mm	
Net Weight (1EA)	1.56kg	1.80kg	1.96kg		

REFERENCE

* Designs and specifications are subject to change without notice.



LG Electronics Inc.

P/NO :3828R-A056E