



# HIGH PERFORMANCE MINI COMPONENT OWNER'S MANUAL

**MODEL : FFH-886AD  
FE-886E  
FFH-986AD  
FE-986E**

**Please read this manual carefully before operating your set.  
Retain it for future reference.**

**Designs and specifications are subject to change without  
notice for improvement.**



## Precautions

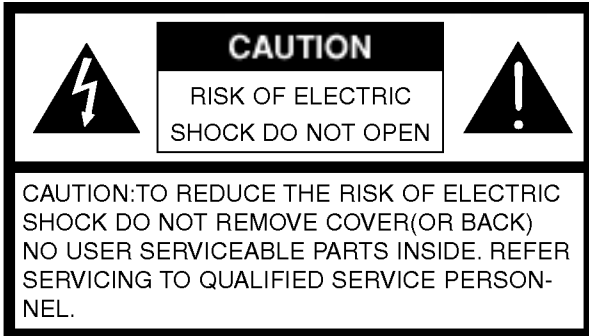

### Explanation Graphical Symbols:



The lightning flash with arrowhead symbol, within an equilateral triangle is intended to alert the user to the presence of uninsulated dangerous voltage within the product's enclosure that may be of sufficient magnitude to constitute a risk of electric shock to persons.



The exclamation point within an equilateral triangle is intended to alert the user to the presence of important operating and maintenance (servicing) instructions in the literature accompanying the appliance.

### WARNING

TO REDUCE THE RISK OF FIRE OF ELECTRIC SHOCK, DO NOT EXPOSE THIS APPLIANCE TO RAIN OR MOISTURE.

To avoid electrical shock, do not open the cabinet, Refer servicing to qualified personnel only.

**The apparatus shall not be exposed to dripping or splashing and that no objects filled with liquids, such as vases, shall be placed on the apparatus.**

### Warning:

Do not install this equipment in a confined space such a book case or similar unit.

### CAUTION

Use of controls or adjustments or performance of procedures other than those specified herein may result in hazardous radiation exposure.

Laser component in this product is capable of emitting radiation exceeding the limit for Class 1.

**CAUTION: INVISIBLE LASER RADIATION WHEN OPEN AND INTERLOCKS DEFEATED. AVOID EXPOSURE TO BEAM.**

**VARNING: OSYNLIG LASERSTRÅLNING NÄR DENNA DEL ÄR ÖPPNAD STRÅLEN ÄR FARLIG.**

**Attention: Quand l'appareil est ouvert, ne pas s'exposer aux radiations invisibles du faisceau laser.**

This label is located on the interior.

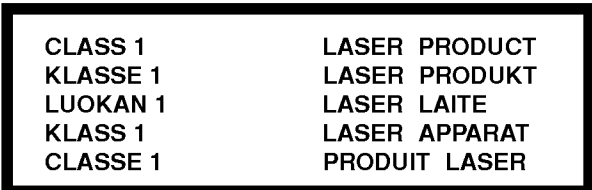

This Compact Disc player is classified as a CLASS 1 LASER product.

The CLASS 1 LASER PRODUCT label is located on the exterior.



This product is manufactured to comply with the radio interference requirements of EEC DIRECTIVE 89/336/EEC, 93/68/EEC and 73/23/EEC.

# Table of Contents

## INTRODUCTION

Precautions	2
Table of Contents	3
Before Use	4
Safety Precautions	4
Notes on Discs	4
Notes on Remote Control	4
Front Panel/ Rear Panel	5
Remote Control	6
Display Window	6
Connections	7
Speaker System Connection	7
Antenna (Aerial) Connections	7

## BEFORE OPERATION

Setting the Voltage (OPTIONAL)	8
Setting the CLOCK	8
Sleep Function	8
Using Microphone (OPTIONAL)	8
Timer Function	9
Audio Adjustment	10
Volume Adjustment	10
Sound Quality Adjustment	10
MUTE	10
SURROUND	10
DISPLAY MODE	10
XDSS (Extreme Dynamic Sound System)	10
DEMO	10
DIMMER	10
Reception of RDS (Radio Data System) Stations - OPTIONAL	10
Auxiliary Function	10



## OPERATION

Presetting the radio stations	11
Listening to the radio	12
Tape Playback	13
Basic Playback	13
To Stop Play	13
Tape Counter Reset	13
To Play Fast Rewind or Fast Forward	13
Dubbing	13
Recording	14
Basic Setting	14
Recording from Radio, CD or Auxiliary source	14
CD to Tape Synchronized Recording	14
CD Playback	15
Basic Playback	15
To Pause Play	15
To Stop Play	15
To Skipping the Track	15
To Play Fast Rewind or Fast Forward	15
To Go to the next discs	15
To Select a disc directly	15
To Replace discs during Playback	16
To Repeat Play	16
To Program Play	17

## Reference

Troubleshooting	18
Specifications	19

### About the symbols for instructions

-  Indicates hazards likely to cause harm to the unit itself or other material damage.
-  Indicates special operating features of this unit.
-  Indicates tips and hints for making the task easier.

## Before Use

### Safety Precautions

#### Handling the unit

##### **When shipping the unit**

The original shipping carton and packing materials come in handy. For maximum protection, re-pack the unit as it was originally packed at the factory.

##### **To keep the surface clean**

Do not use volatile liquids, such as insecticide spray, near the unit. Do not leave rubber or plastic products in contact with the unit for a long period of time. They will leave marks on the surface.

#### Cleaning the unit

##### **To clean the cabinet**

Use a soft, dry cloth. If the surfaces are extremely dirty, use a soft cloth lightly moistened with a mild detergent solution. Do not use strong solvents, such as alcohol, benzene, or thinner, as these might damage the surface of the unit.

### Notes on Discs

#### Handling discs

Do not touch the playback side of the disc.  
Hold the disc by the edges so that fingerprints will not get on the surface.  
Do not stick paper or tape on the disc.

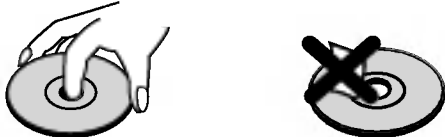

#### Storing discs

After playing, store the disc in its case.  
Do not expose the disc to direct sunlight or sources of heat, or leave it in a parked car exposed to direct sunlight, as there may be a considerable temperature increase inside the car.

#### Cleaning discs

Fingerprints and dust on the disc can cause poor picture quality and sound distortion. Before playing, clean the disc with a clean cloth. Wipe the disc from the center out.

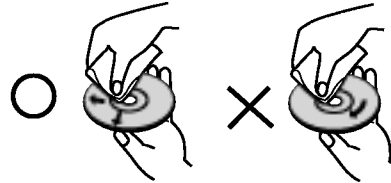

Do not use strong solvents such as alcohol, benzene, thinner, commercially available cleaners, or anti-static spray intended for analog records.

#### Notes on Remote Control

##### Remote Control Operation Range

Point the remote control at the remote sensor and press the buttons.

- **Distance:** About 23 ft (7 m) from the front of the remote sensor.
- **Angle:** About 30° in each direction of the front of the remote sensor.

##### Remote control battery installation

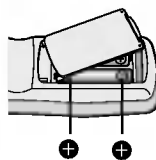

Detach the battery cover on the rear of the remote control, and insert two R03 (size AAA) batteries with **+** and **+** aligned correctly.

##### **⚠ Caution**

Do not mix old and new batteries. Never mix different types of batteries (standard, alkaline, etc.).

## Front Panel/Rear Panel

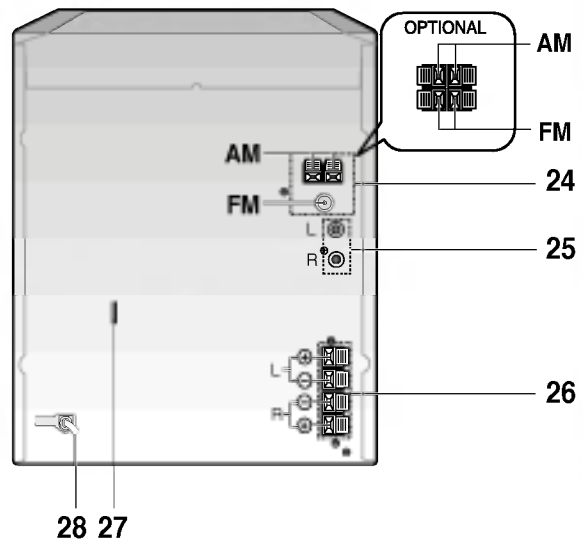
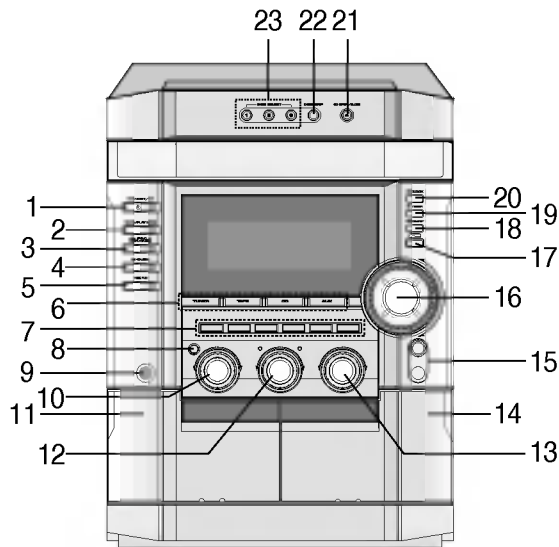

1. POWER (STANDBY/ON) button
2. • PLAY MODE button : OPTIONAL
- COUNTER RESET (COUNTER) button : OPTIONAL
- DEMO button
3. • CD SYNC. button
- NORMAL DUBBING button
4. • HIGH DUBBING button
5. RECORD/ RECORD PAUSE (● REC/||) button
6. FUNCTION SELECT buttons (TUNER, TAPE, CD, AUX)
7. • TUNING DOWN button
- PRESET DOWN button
- REWIND (◀◀) button
- BACKWARD PLAY (◀) button : OPTIONAL
- STOP (■)/ CLEAR button
- FORWARD PLAY (▶) button
- TUNING UP button
- PRESET UP button
- FAST FORWARD (▶▶) button
- CD PAUSE button
- SET (CLOCK/ TIMER) button
- COUNTER RESET button : OPTIONAL
- RDS button (OPTIONAL)
8. • PROG. button
- MEMO. button
- ENTER button
9. HEADPHONE SOCKET (PHONES):  $\phi$  6.3mm
10. EQUALIZER knob (EQ)
11. ▲ PUSH OPEN position - TAPE A (DECK A)
12. SURROUND ADJUST knob
13. MULTI JOG SHULLTE
14. ▲ PUSH OPEN position - TAPE B (DECK B)
15. • MIC SOCKET (MIC):  $\phi$  6.3mm - OPTIONAL
- MIC VOLUME KNOB (MIC VOL.) - OPTIONAL
16. VOLUME DOWN/UP knob
17. XDSS button
18. MODE/RIF button
19. TIMER button
20. CLOCK button
21. CD OPEN/ CLOSE(CD▲) button
22. DISC SKIP button
23. DISC DIRECT PLAY buttons (DISC1, DISC2, DISC3)
24. ANTENNA TERMINAL
25. AUXILIARY INPUT JACK
26. SPEAKER TERMINAL
27. VOLTAGE SELECT SWITCH : OPTIONAL
28. POWER CORD

## Remote Control

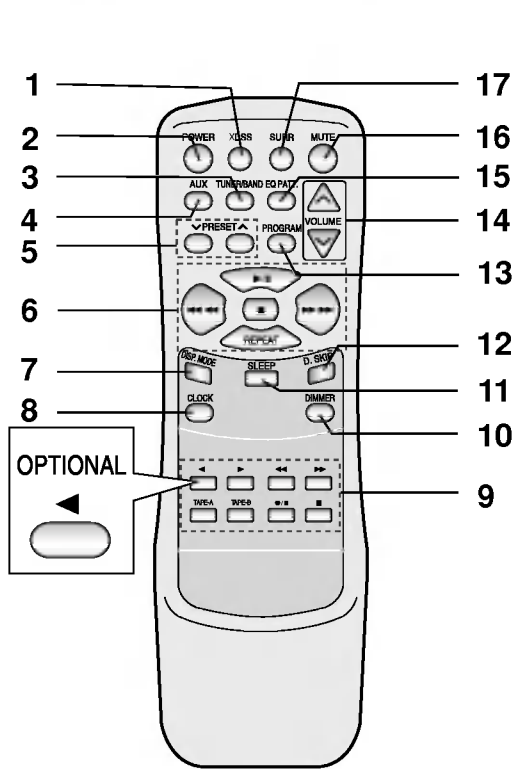

1. XDSS button
2. POWER button
3. TUNER/BAND button
4. AUX button
5. PRESET (∨/∧) button
6. CD FUNCTION buttons
  - PLAY/ PAUSE (▶/⏸) button
  - CD STOP (■) button
  - CD SKIP (◀◀◀/▶▶▶) button
  - FAST REWIND/ FAST FORWARD PLAY (◀◀◀/▶▶▶) button
  - REPEAT button
7. DISPLAY MODE button
8. CLOCK button
9. TAPE FUNCTION buttons
  - RECORD/ RECORD PAUSE (●/⏸) button
  - BACKWARD PLAY (◀) button : OPTIONAL
  - FORWARD PLAY (▶) button
  - TAPE STOP button (■)
  - FAST FORWARD PLAY (▶▶▶) button
  - FAST REWIND PLAY (◀◀◀) button
  - TAPE-A/B SELECT button
10. DIMMER button
11. SLEEP button
12. DISC SKIP (D.SKIP) button
13. PROGRAM button
14. VOLUME CONTROL (∨/∧) button
15. EQUALIZER PATTERN (EQ PATT.) button
16. MUTE button
17. SURROUND (SURR.) button

## Display Window

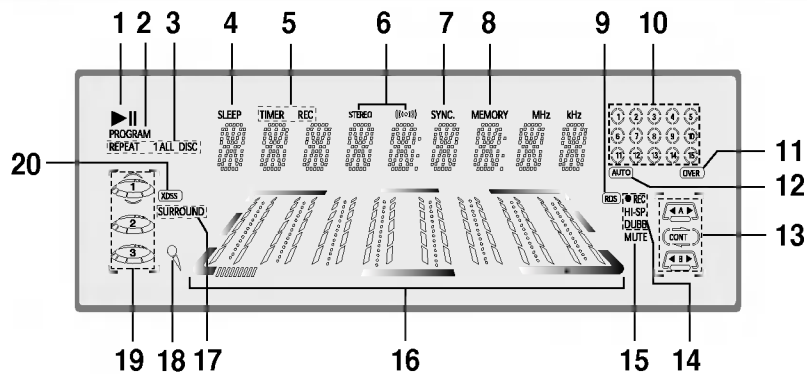

1. PLAY/ PAUSE indicator
2. PROGRAM indicator
3. REPEAT indicator
4. SLEEP indicator
5. TIMER indicator
6. FM STEREO RECEIVING indicator
7. CD SYNC. indicator
8. MEMORY indicator
9. RDS indicator (OPTIONAL)
10. CD TRACK indicator
11. CD TRACK OVER indicator
12. AUTO TUNE RECEIVING indicator
13. • PLAY MODE SELECT indicator
14. • TAPE PLAY DIRECTION indicator
15. • TAPE A/B SELECT indicator
16. • RECORD / RECORD PAUSE indicator
17. • NORMAL DUBBING indicator
18. • HIGH DUBBING indicator
19. MUTE indicator
20. LEVEL indicator
21. SURROUND indicator
22. MIC indicator - OPTIONAL
23. DISC Number indicator
24. XDSS indicator

## Connections

### Speaker System Connection

Connect the speakers using the supplied speaker cords by matching the colors of the terminals and those of the cords. To obtain the best possible surround sound, adjust the speaker parameters (distance, level, etc.).

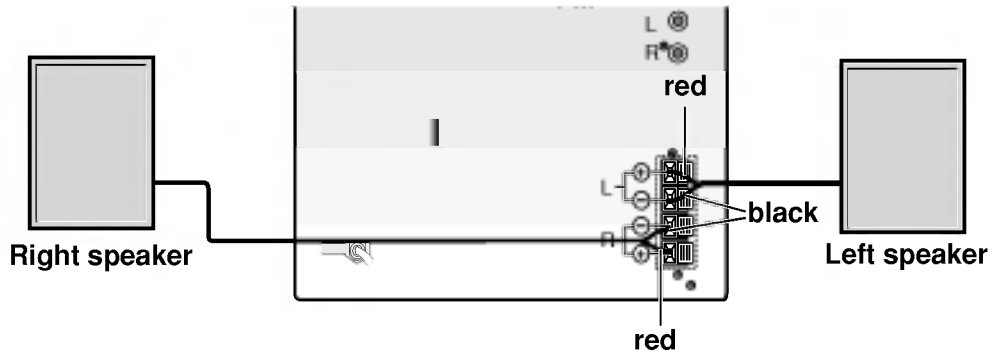

#### Notes

- Be sure to match the speaker cord to the appropriate terminal on the components: + to + and – to –. If the cords are reversed, the sound will be distorted and will lack base.
- If you use front speakers with low maximum input rating, adjust the volume carefully to avoid excessive output on the speakers.
- Do not disassemble the front cover of supplied speaker.

### Antenna (Aerial) Connections

Connect the supplied FM/AM antennas for listening to the radio.

- Connect the AM loop antenna to the AM antenna connector.
- Connect the FM wire antenna (or FM “T” antenna) to the FM 75Ω coaxial/300Ω connector.

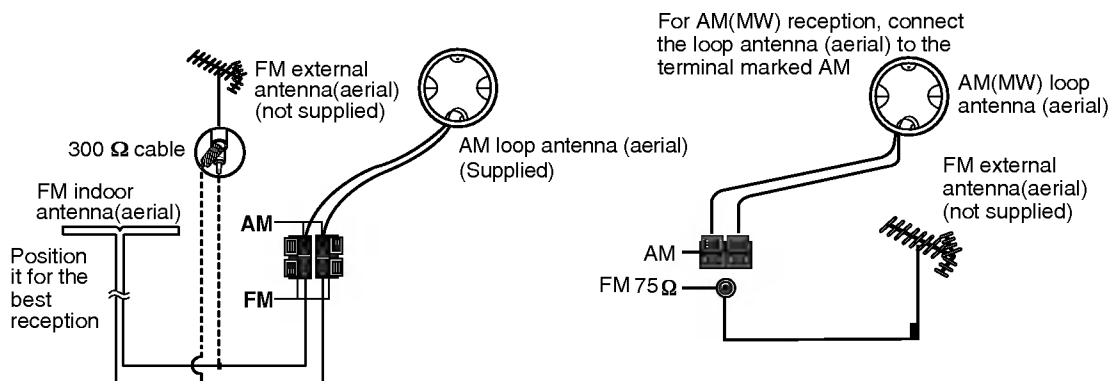

#### Notes

- To prevent noise pickup, keep the AM loop antenna away from the unit and other components.
- Be sure to fully extend the FM wire antenna.
- After connecting the FM wire antenna, keep it as horizontal as possible.

## Setting the Voltage (OPTIONAL)

If your set is equipped with a voltage selector at the back side, be sure to set it to your local power supplied before connecting the AC power cord.

## Setting the CLOCK

**1** Press **CLOCK**.  
(If the clock is requires setting, press and hold **CLOCK** for more than 2 seconds.)  
- The hours begin to blink.

**2** Select a 24 hour cycle or 12 hour cycle by turning **MULTI JOG SHUTTLE**.



(12HR)

or



(24HR)

**3** Press **SET** to confirm the selected hour cycle.

**4** Use **MULTI JOG SHUTTLE** to set the correct hours.

**5** Press **SET**.

**6** Use **MULTI JOG SHUTTLE** to set the correct minutes.

**7** Press **SET** and the correct time is shown on the display.

**8** Press **CLOCK** at any time to display the time for about 5 seconds.

## Sleep Function

When the sleep timer is used, the power is automatically turned off after the specified time has elapsed.

**1** To specify the time delay before the power is turned off, press **SLEEP**.

In the display window you can see *SLEEP 90* for about 5 seconds. This means that the system turns off automatically after 90 minutes.

Each time the button is pressed the time interval before it turns off is reduced by 10 minutes. i.e. 80...70... etc.

Select the desired time to turn off.

**2** To check the remaining time until the power is turned off.

While the sleep function is active press **SLEEP** briefly. The time remaining until it turns off is displayed for about 5 seconds.

### Note

If you press **SLEEP** while the sleep time is displayed, the **SLEEP** time is reset.

### To cancel the sleep timer mode

If you wish to stop the function, press the **SLEEP** button repeatedly until 10 appears, and then press **SLEEP** once again while 10 is displayed.

## Using Microphone (OPTIONAL)

You can sing to a music source by connecting a microphone to the unit.

**1** Connect your microphone (not supplied) to the **MIC** socket.

**2** Play a music you want.

**3** Sing along with the accompaniment.  
Adjust the microphone volume by turning **MIC VOLUME KNOB**.

### For your reference

You can record during using microphone.  
Refer to the "Recording" explanation section.

### Notes

- When not using the microphone, set the **MIC** volume knob to minimum or turn off the **MIC** and remove the microphone from the **MIC** socket.
- If the microphone is set too near the speaker, a howling sound may be produced. In this case, move the microphone away from the speaker or decrease the sound level by using the **MIC** volume control.
- If sound through the microphone is extremely loud, it may be distorted. In this case, turn the **MIC** volume control toward minimum.



## Timer Function

With the **TIMER** function you can have the radio reception and recording, CD play, tape play or auxiliary source play and recording turned on and off at the time desired.

- 1** Press **CLOCK** to check the current time.
- 2** Press **"TIMER"** to enter the timer setting mode. (If you want to correct the previous memorized **TIMER** setting, press and hold the **"TIMER"** button more than 2 seconds.)  
The previous memorized timer on time and **"TIMER"** appears in the display. Each function : **TUNER-CD-TAPE** flashes in the display window in turn.
- 3** Press **SET** when the desired function is flashing.
- 4** If you select the **TUNER**:  
**PLAY** and **REC** flash in the display window alternately for about 3 seconds. Press **SET** to confirm the desired operating mode.  
**REC**: **TUNER** recording and play  
**PLAY**: **TUNER** play only
  - If you have selected the **CD** or **TAPE**, ignore step 4.
- 5** When you have selected the **TUNER**;  
Select the previous memorized preset number with **MULTI JOG SHUTTLE** and press **SET**.  
The hour **"ON"** display flashes.
  - If you have selected the **CD** or **TAPE**, ignore step 5.
- 6** Set the hour to switch on by turning **MULTI JOG SHUTTLE**.
- 7** Press **SET** to confirm the hour to switch on.  
The minute **'ON'** display flashes.
- 8** Set the minute to switch on by turning **MULTI JOG SHUTTLE**.
- 9** Press **SET** to confirm the minute to switch on.  
The hour **'OFF'** now flashes in the display.
- 10** Set the hour to switch off turning **MULTI JOG SHUTTLE**.
- 11** Press **SET**.
- 12** Set the minute to switch off turning **MULTI JOG SHUTTLE**.
- 13** Press **SET**.
- 14** Adjust the volume level turning **MULTI JOG SHUTTLE**.
- 15** Press **SET**.  
**"TIMER"** appears in the display window and the timer setting has been completed.
- 16** Switch the system off.  
The selected function is automatically switched on and off at the time set.

### To cancel or check the timer

Each time the **"TIMER"** button is pressed you can select the timer set or cancel. You can also check the timer setting status.

To activate or check the timer, press the **"TIMER"** button so that **"TIMER"** appears in the display window. To cancel the **TIMER**, press the **"TIMER"** button so that **"TIMER"** disappears in the display window.

## Audio Adjustment

### Volume Adjustment

- Turn **VOLUME DOWN/UP knob** clockwise to increase the sound level, or counterclockwise to decrease it.
- Press **VOLUME CONTROL ( ^ )** to increase the sound level, or press the **VOLUME CONTROL ( v )** to decrease it on the remote control.

### Sound Quality Adjustment

#### To activate stereo sound

- You can choose between 8 fixed sound impressions and 1 USER MODE.  
Select a desired sound mode by using the **EQ PATT.** button ( or turning EQ knob on the front panel).
- When you select USER MODE, press the **ENTER** button repeatedly.  
You can select Three of sound mode (BASS, MIDDLE, TREBLE).
- Each you press the button the indication changes as follows.

FLAT → ROCK → POP → VOCAL → CLASSIC



USER MODE ← SAMBA ← SALSA ← JAZZ



#### Headphone Jack

Connect a stereo headphone plug (∅6.3mm) into the headphone jack.

The speakers are automatically disconnected when you plug in the headphones (not supplied).

### MUTE

Press **MUTE** to mute your unit.

You can mute your unit in order, for example, to answer the telephone, "MUTE" indicator flashes in the display window.

### SURROUND

#### To activate surround mode

- You can choose between 6 fixed sound impressions.
- Select a desired surround mode by using the **SURROUND** button.
- Each you press the button the indication changes as follows.

SURROUND OFF → SIMULATED LOW → SIMULATED HIGH



MOVIE HIGH ← MOVIE LOW ← MUSIC HIGH ← MUSIC LOW



### DISPLAY MODE

Whenever you press **DISPLAY MODE**, you can enjoy the spectrum change with 6 types in the display.

### XDSS (Extreme Dynamic Sound System)

- Press **XDSS** to reinforce treble, bass and surround effect.
- Each you press the button the indication changes as follows.

XDSS OFF → XDSS1 ON → XDSS2 ON



### DEMO

Press **DEMO** in power off state to demonstrate the function in the display.

To cancel it, press **POWER** or **DEMO** again. During demonstration in power-on status you can cancel it by using the other buttons.

### DIMMER

This function is darken the display window by half in power-on status. Press **DIMMER** once, and the display is darken, and if you press it once more, the display will darken by half too. To cancel it press the button again.

### Reception of RDS (Radio Data System) Stations - OPTIONAL

#### What is RDS?

RDS (Radio Data System) is a system gradually being introduced on FM in many countries, where by an inaudible stream of data is transmitted in addition to the normal radio signal. This data contains various information including station/ transmitter identification, traffic information and a list of alternative frequencies for the radio station being received.

**1**

Press **TUNER/BAND** repeatedly to select **FM**.

**2**

Select a desired station by pressing **TUNING**

**◀◀◀ / ▶▶▶**.

When the RDS transmission is received, the display shows the program service name (PS) after RDS indicator appears.

**3**

Press the **RDS** to recall the frequency.

**N**

#### Notes

- RDS is only available for FM reception.
- The PS (PROGRAM SERVICE) NAME is displayed automatically when a RDS station is received.

## Auxiliary Function

**1**

Connect an auxiliary device i.e. TV or VCR, via the rear mounted AUX phone jacks.

**2**

Press **AUX**.



**N**

#### Notes

You can also record from the auxiliary input source, see Recording Section.

## Presetting the radio stations

You can preset 30 stations for FM and AM. Before tuning, make sure that you have turned down the volume to the minimum.

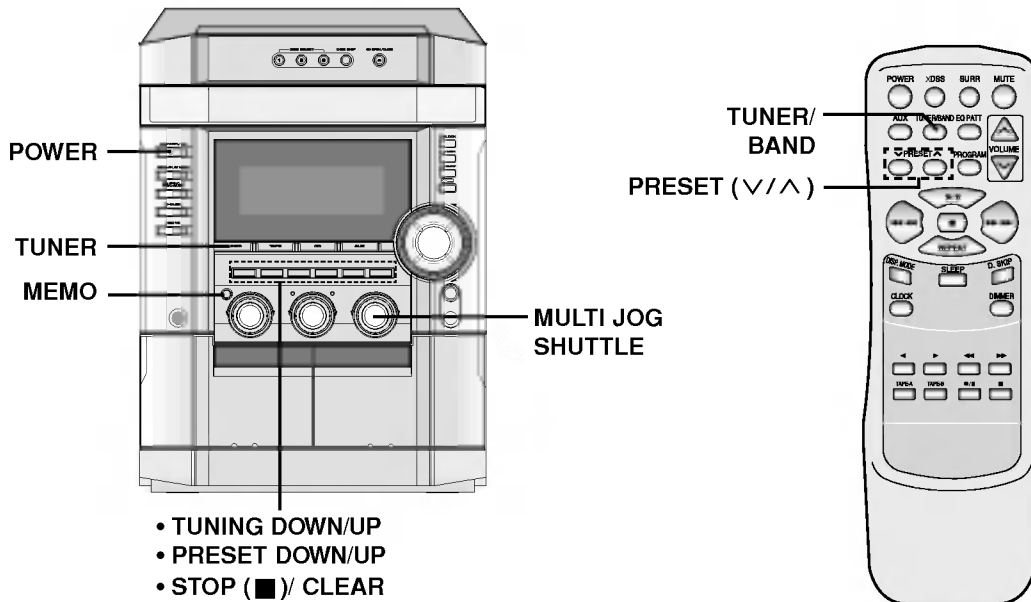

- 1** Press **POWER** to turn on the unit.
- 2** Press **TUNER** or **TUNER/BAND** until the **FM** or **AM** appears in the display window.
- 3** And then every time you press **TUNER** or **TUNER/BAND**, **FM** and **AM** changes alternately.
- 4** Press **TUNING DOWN/UP** on the front panel until the frequency indication starts to change, then release.  
Scanning stops when the unit tunes in a station.
- 5** Press **MEMO** on the front panel.  
A preset number will flash in the display window.
- 6** Press **PRESET DOWN/UP** (or **PRESET (∇/∧)** on the remote control) to select the preset number you want.
- 7** Press **MEMO** on the front panel again.  
- The station is stored.
- 8** Repeat steps 3 to 6 to store other stations.

### To tune in a station with a weak signal

Turn **MULTI JOG SHUTTLE** in step 3 to tune in the station manually.

### To clear all the memorized stations

Press and hold **MEMO** on the front panel for about two seconds, "CLEAR" appears in the display window and then press **CLEAR** again, the stations are cleared.

### For your reference

If all stations have already been entered, **FULL** message will appear in the display window for a moment and then a preset number will flash. To change the preset number, follow the steps 6-7 on the left side.

### To recall presets

Press and hold **PRESET DOWN/UP** ( or **PRESET (∇/∧)** on the remote control) until the desired preset number appears or press it repeatedly.

### Tuning in automatically

Press **TUNING DOWN/UP**.

### Tuning in manually

Turn **MULTI JOG SHUTTLE**.

## Listening to the radio

Preset radio stations in the units memory first (see "Presetting radio stations" on the previous page).

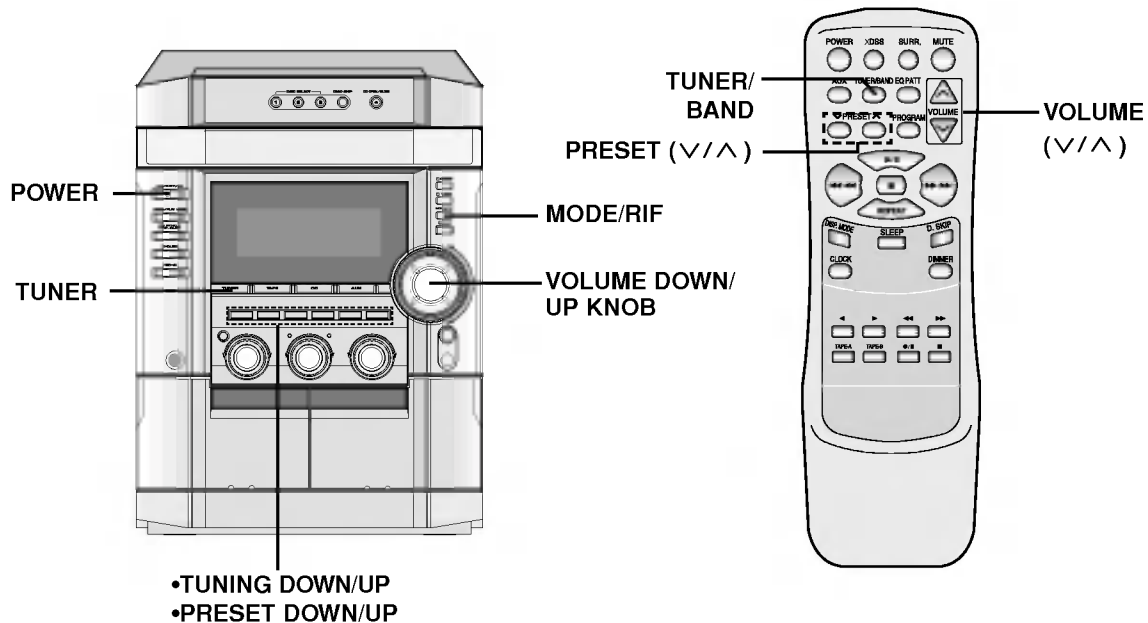

**1** Press **TUNER** or **TUNER/BAND** until **AM** or **FM** appears in the display window. The last received station is tuned in.

**2** Press **PRESET DOWN/UP** (or **PRESET ∇/∧** on the remote control) repeatedly to select the preset station you want. Each time you press the button, the unit tunes in one preset station at a time.

**3** Adjust the volume by rotating **VOLUME DOWN/UP KNOB** (or pressing **VOLUME (∇/∧)** on the remote control) repeatedly.

### To listen to non-preset radio stations

- For manual tuning, see "Tuning in manually" on the previous page.
- For automatic tuning, see "Tuning in automatically" on the previous page.

### To turn off the radio

Press **POWER** to turn the unit off or select another function mode (**CD**, **TAPE** or **AUX**).

### For your reference

- **If an FM program is noisy**  
Press **MODE/RIF** so that "STEREO" disappears in the display window. There will be no stereo effect, but the reception will improve. Press **MODE/RIF** again to restore the stereo effect.
- **To improve reception**  
Reposition the supplied antennas.

### Notes

- Use **MODE/RIF** (Radio Interference Filter) function to switch the mono reception if stereo reception is distorted by noise.
- When recording the **MW(AM)** or **LW** broadcast, beat noises occur. If it does, press **MODE/RIF** once.

# Tape Playback

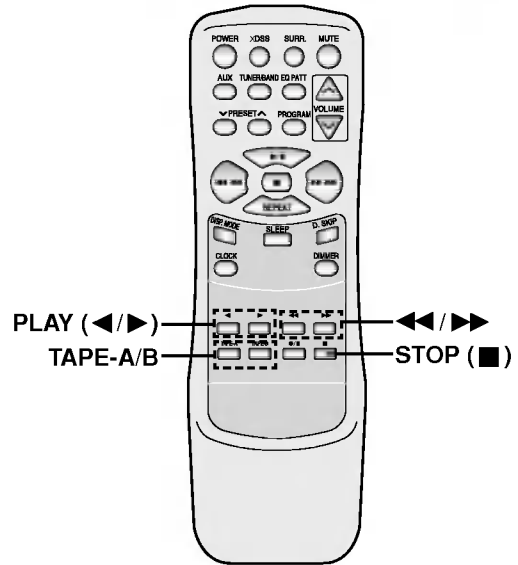
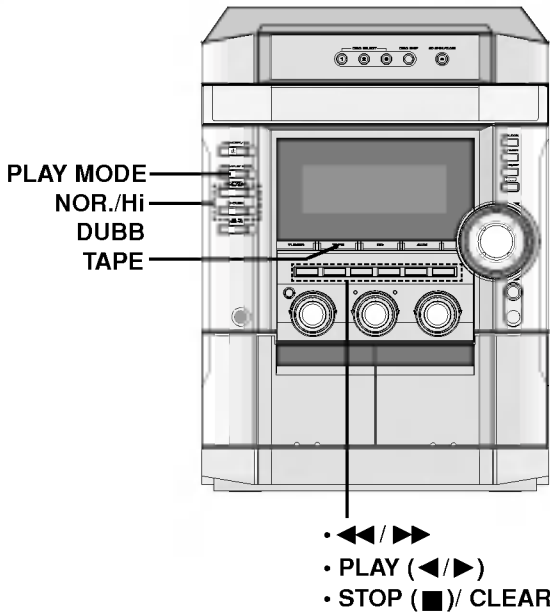

OPERATION

## Basic Playback

- 1** Press TAPE repeatedly or TAPE-A/B to select TAPE A or TAPE B.  
("NO TAPE" appears in the display window.)
- 2** Open cassette TAPE A (or B) by pushing ▲ PUSH OPEN position.
- 3** Insert one or two cassette with the tape side to the bottom and then close the TAPE A (or B).
- 4** Press PLAY (▶ or ◀: OPTIONAL).

### AUTO STOP DECK (TAPE A/B)

After auto stop deck plays only front side, the unit stops automatically.

### AUTO REVERSE DECK (TAPE A or B): OPTIONAL

You can select direction of the cassette you want by pressing PLAY MODE.

Pressing	Display	Function
Once	↔	After the cassette of TAPE A or B plays front or reverse (backward play) side, stops automatically.
Twice	↔↔	After the cassette of TAPE A or B plays front and reverse side, stops automatically.
Three times	↔↔↔	After the cassette of TAPE A or B plays six times repeatedly front and reverse side, stops automatically.
Forth	↔↔ (CONT.)	After a cassette of TAPE A and B plays six times repeatedly front and reverse side, stops automatically.

## To Stop Play

Press STOP(■) during playback.

## Tape Counter Reset

Press COUNTER during playback.

Playing time appears "TAP A(or B) 0000" in display window.

## To Play Fast Rewind or Fast Forward

After pressing and holding ◀◀/▶▶ on the front panel or ◀◀/▶▶ on the remote control during playback, press PLAY (▶) at the point you want.

## Dubbing

This function shows how to record from tape to tape.

- 1** Press TAPE or TAPE-A/ B.
  - Cassette TAPE A- Insert a playback tape to dub.
  - Cassette TAPE B- Insert a blank tape.

- 2** Press NOR./ Hi DUBB. as follow.

Pressing	Display	Function
NOR.- DUBBING	● REC DUBB.	Normal speed dubbing
Hi- DUBBING	● REC HI-SP. DUBB.	Double speed dubbing

To stop dubbing, Press STOP(■).

## Recording

Wind the tape to the point recording starts.  
Use only normal tapes.  
You can record from cassette deck B only.

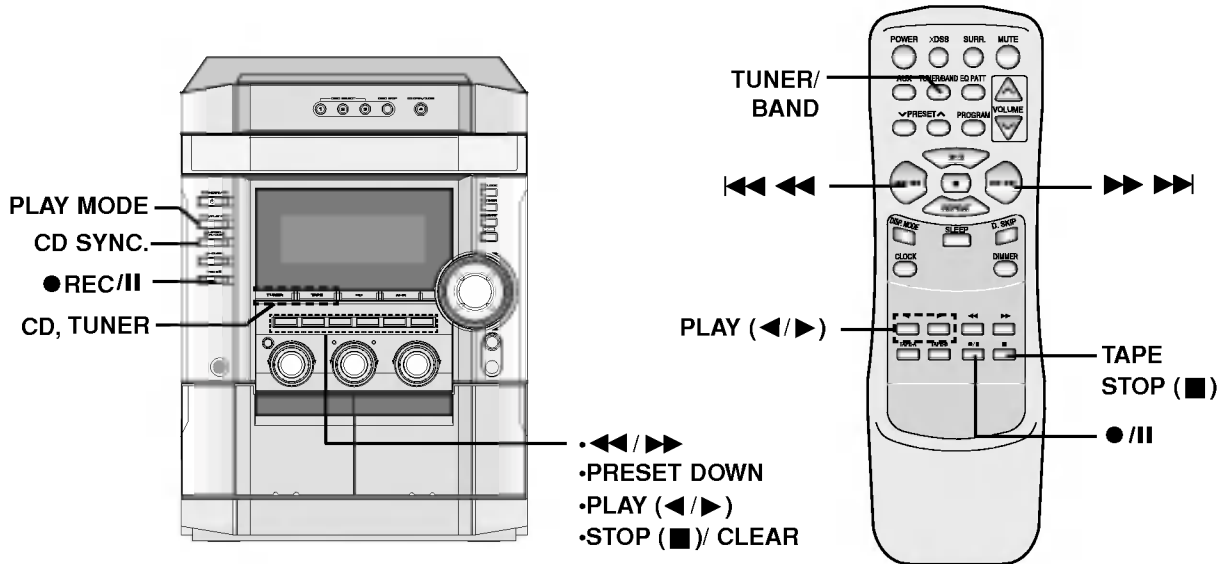

### Basic Setting

**1** Press CD or TUNER/BAND.

**2** Open the cassette TAPE B and insert a blank cassette into the cassette compartment.

To set the recording direction :OPTIONAL  
Press **PLAY MODE** repeatedly to set the recording direction.

Pressing	Display	Function
Once	→←	Recording front side.
Twice	→←)	Recording front and reverse side.
Three times	(→←)	
Forth	(→←) (CONT.)	

### Recording from Radio, CD or Auxiliary source

**1** Press RECORD/ RECORD PAUSE (●REC/II or ●/II) button .  
“●REC” flashes and holds the cassette in pause mode.

**2** Press PLAY(▶) on the front panel.  
The recording begins.

### To Pause recording

To pause the recording, press RECORD/ RECORD PAUSE (●REC/II or ●/II) button again.  
“●REC” flashes in display window.

### To Stop recording

Press TAPE STOP(■).

### CD to Tape Synchronized Recording

The CD synchro recording function dubs a complete CD and programmed titles automatically into a cassette.

**1** Press CD SYNC. in stop mode.  
“●REC” flashes and “CD SYNC” displays in the display window.

**2** The synchronized recording is started automatically after about 7 seconds.

### Notes

- If you wish to record from the desired track, select the desired track with |◀◀◀◀/▶▶▶▶| before commencing CD synchro recording.
- The function change is not possible during recording.

## CD Playback

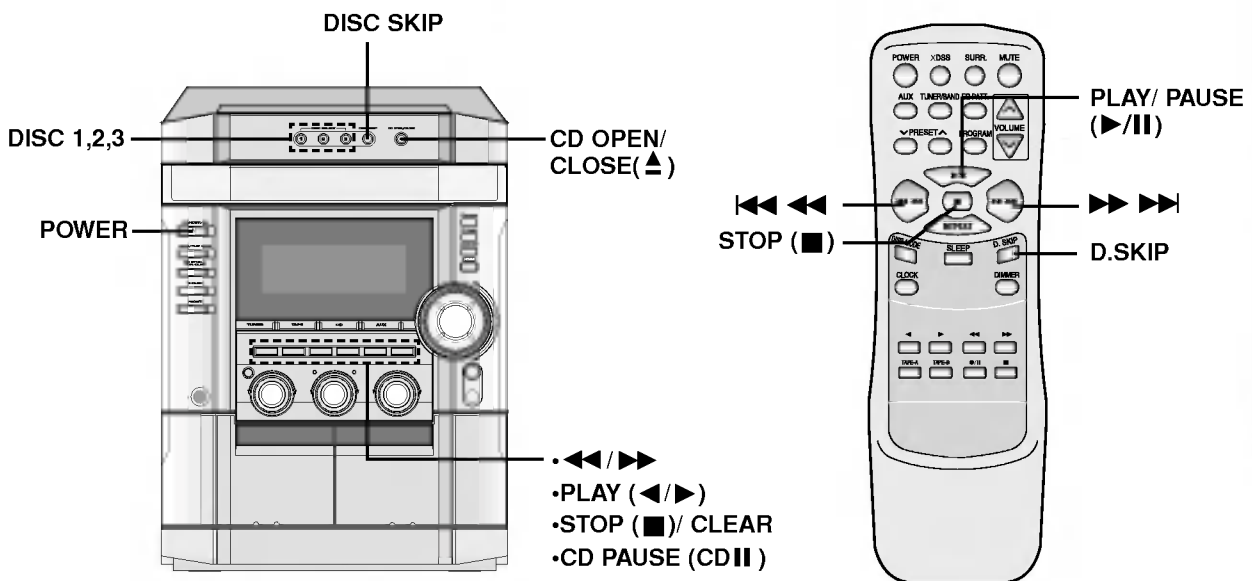

### Basic Playback

- 1** Press **POWER** to turn on the unit.
- 2** Press the **CD** button to enter the CD mode. If no disc is entered in the disc drawer, the "NO DISC" indicator is displayed.
- 3** Press **CD OPEN/CLOSE(▲)** and place the disc into the disc tray. The disc on the left (DISC 1) is played first.

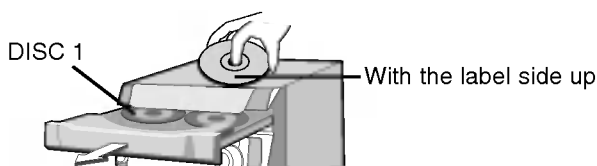

#### Note

To load an 8cm(3 inch) disc, put it onto the inner circle of the tray.

- 4** Press **CD OPEN/CLOSE(▲)** to close the disc compartment.
- 5** Press **PLAY (▶)** or **PLAY/ PAUSE (▶/||)** on the remote control.

### To Pause Play

Press **CD PAUSE (CD||)** or **PLAY/ PAUSE (▶/||)** on the remote control during playback. Press this button again it to resume play.

### To Stop Play

Press **STOP(■)** during playback.

### To Skipping the Track

- Press **▶▶** on the front panel or **CD SKIP ▶▶▶▶** on the remote control to go to the next track.
- When **◀◀** button on the front panel or **CD SKIP ◀◀◀◀** button on the remote control is pressed once midway through a track, the player returns to the start of that track. When it is pressed again, a track is skipped each time the button is pressed.

### To Play Fast Rewind or Fast Forward

After pressing and holding **◀◀/▶▶** on the front panel or **◀◀◀◀/▶▶▶▶** on the remote control during playback, press **PLAY (▶)** at the point you want.

### To Go to the next discs

Press **DISC SKIP** or **D.SKIP** during playing or stopping.

### To Select a disc directly

Press **DISC 1**, **DISC 2** or **DISC 3** during playing or stopping.

When you press **DISC 1-3** before playing a disc, the unit will automatically start playing the selected disc.

## CD Playback (Cont'd)

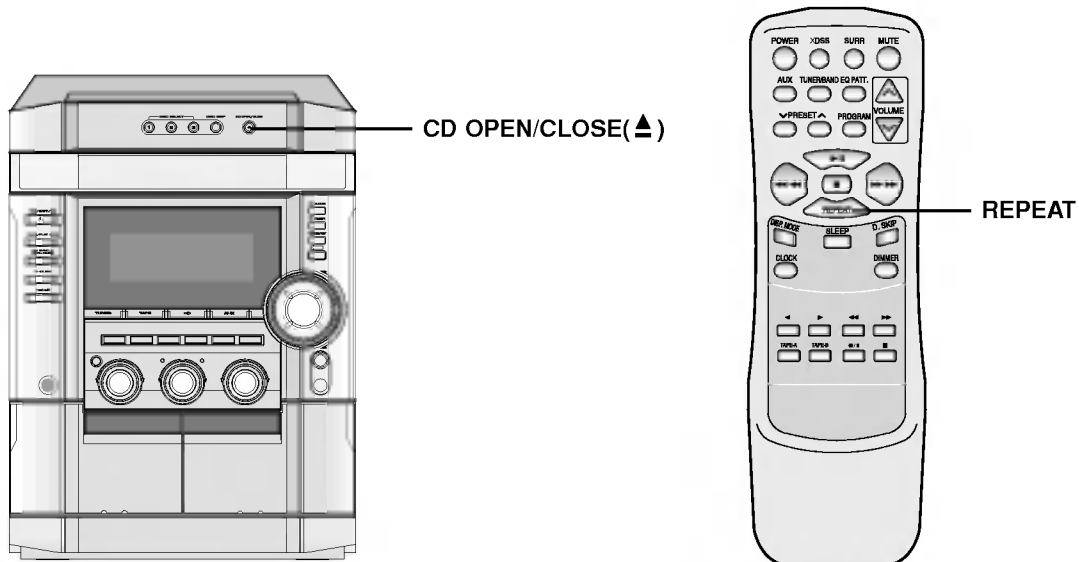

### To Replace discs during Playback

You can open the disc tray during playing a disc to check what discs are to be played next and replace discs without interrupting playback of the current disc.

- 1 Press the CD OPEN/CLOSE (▲).**  
The disc tray is opened. Two disc compartments appear. Even if the unit is playing a disc, it doesn't stop playing.
- 2 Replace discs in the compartments with new ones.**  
The unit plays the disc in the left compartment after the current disc, and then the one in the right compartment.
- 3 Press CD OPEN/CLOSE (▲).**  
The CD door is closed.

#### **N** Notes

- Do not place more than one compact disc on one disc tray at the same time.
- Do not push the disc tray to close CD door, as you may damage the unit.

### To Repeat Play

#### **To play one track repeatedly.**

Press **REPEAT** once during playback.  
- "REPEAT 1" appears in the display window.

#### **To play one disc repeatedly.**

Press **REPEAT** again during playback.  
- "REPEAT 1 DISC" appears in the display window.

#### **To play all tracks on all discs repeatedly**

Press **REPEAT** once more during playback.  
- "REPEAT ALL DISC" appears in the display window.

#### **To cancel repeat play**

- Press **REPEAT** several times until repeat indicators disappear.

#### **Program repeat play**

- Press **REPEAT** once during program play.
  - "REPEAT 1" appears in the display window. (One track repeat)
- Press **REPEAT** again during program play.
  - "REPEAT ALL DISC" appears in the display window. (All program repeat)



## CD Playback (Cont'd)

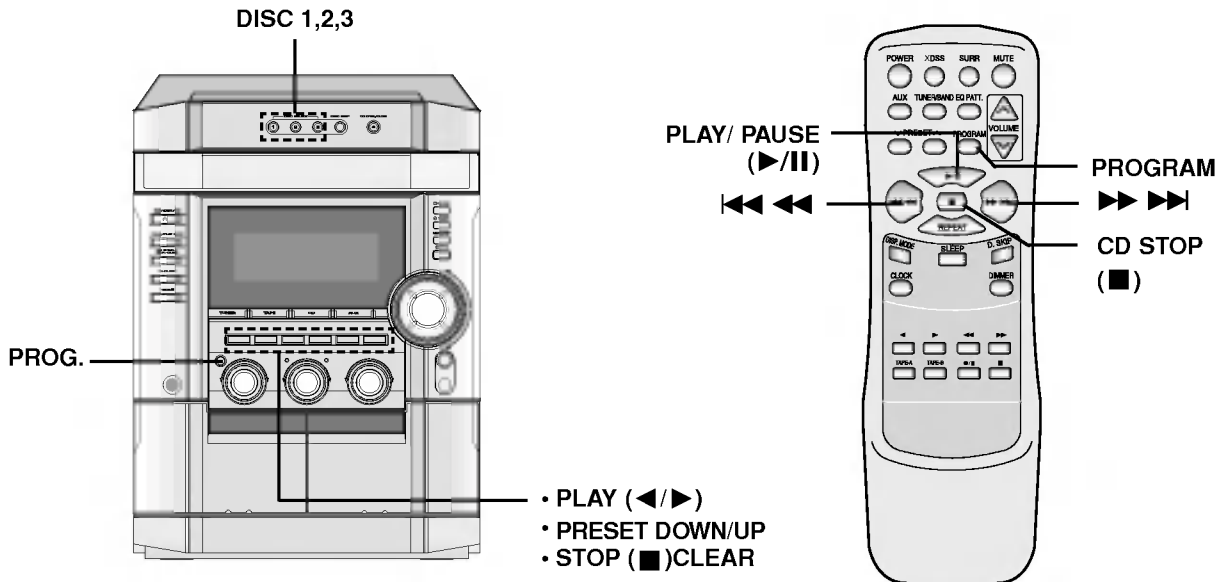

### To Program Play

You can arrange the order of the tracks on the discs and create your own program. The program can contain up to 20 tracks.

- 1** Press **PROG.** (or **PROGRAM** on the remote control) on the stop mode.
- 2** Press **D.SKIP** or **DISC DIRECT PLAY (DISC1/2/3)** to select the disc.
- 3** Press **PRESET DOWN/UP** or **MULTI JOG SHUTTLE** on the front panel or **CD SKIP** ◀◀◀ / ▶▶▶ on the remote control to select the track.
- 4** Press **PROG.** (or **PROGRAM** on the remote control).
- 5** Repeat 1~4.
- 6** Press **PLAY(▶)** (or **PLAY/ PAUSE (▶/||)** on the remote control).

### To check program contents

Press **PROG.** (or **PROGRAM** on the remote control) on the stop mode.  
 - The disc, track and program number will be displayed.

### To clear program contents

Press **PROG.** (or **PROGRAM** on the remote control) on the stop mode. And then press **CLEAR** on the front panel or **CD STOP(■)** on the remote control.

### To add program contents

1. Press **PROG.** (or **PROGRAM** on the remote control) repeatedly on the program stop mode until "Disc Number" blinks.
2. Repeat 2~5 on the left side.

### To modify program contents

1. Press the **PROG.** (or **PROGRAM** on the remote control) to display program number you want to modify.
2. Repeat 2~4 on the left side.

## Troubleshooting

Check the following guide for the possible cause of a problem before contacting service.

Symptom	Cause	Correction
No power.	<ul style="list-style-type: none"> <li>The power cord is disconnected.</li> </ul>	<ul style="list-style-type: none"> <li>Plug the power cord into the wall outlet securely.</li> </ul>
No sound.	<ul style="list-style-type: none"> <li>The audio cables are not connected securely.</li> </ul>	<ul style="list-style-type: none"> <li>Connect the audio cable into the jacks securely.</li> </ul>
	<ul style="list-style-type: none"> <li>The power of the external source equipment is switched off.</li> </ul>	<ul style="list-style-type: none"> <li>Turn on the equipment connected with the audio cable.</li> </ul>
	<ul style="list-style-type: none"> <li>The Digital Audio Output is set to the wrong position.</li> </ul>	<ul style="list-style-type: none"> <li>Set the Digital Audio Output to the correct position, then turn on the unit again by pressing POWER.</li> </ul>
The unit does not start playback.	<ul style="list-style-type: none"> <li>No disc is inserted.</li> </ul>	<ul style="list-style-type: none"> <li>Insert a disc.</li> </ul>
	<ul style="list-style-type: none"> <li>An unplayable disc is inserted.</li> </ul>	<ul style="list-style-type: none"> <li>Insert a playable disc.</li> </ul>
	<ul style="list-style-type: none"> <li>The disc is placed upside down.</li> </ul>	<ul style="list-style-type: none"> <li>Place the disc with the playback side down.</li> </ul>
	<ul style="list-style-type: none"> <li>The disc is not placed within the guide.</li> </ul>	<ul style="list-style-type: none"> <li>Place the disc on the disc tray correctly inside the guide.</li> </ul>
	<ul style="list-style-type: none"> <li>The disc is dirty.</li> </ul>	<ul style="list-style-type: none"> <li>Clean the disc.</li> </ul>
The remote control does not work properly.	<ul style="list-style-type: none"> <li>The remote control is not pointed at the remote sensor of the unit.</li> </ul>	<ul style="list-style-type: none"> <li>Point the remote control at the remote sensor of the unit.</li> </ul>
	<ul style="list-style-type: none"> <li>The remote control is too far from the unit.</li> </ul>	<ul style="list-style-type: none"> <li>Operate the remote control within about 23 ft (7 m).</li> </ul>
	<ul style="list-style-type: none"> <li>There is an obstacle in the path of the remote control and the unit.</li> </ul>	<ul style="list-style-type: none"> <li>Remove the obstacle.</li> </ul>
	<ul style="list-style-type: none"> <li>The batteries in the remote control are exhausted.</li> </ul>	<ul style="list-style-type: none"> <li>Replace the batteries with new ones.</li> </ul>

## Specifications

SECTION		MODEL	FFH-886AD	FFH-986AD
[General]	Power supply	Refer to the back panel of the unit.		
	Power consumption		150W	190W
	Mass	10.5kg		
	External dimensions (W x H x D)	280 x 370 x 399 mm		
[CD]	Frequency response	40 - 18000 Hz		
	Signal-to-noise ratio	70 dB		
	Dynamic range	70 dB		
[Tuner]	FM	Tuning Range	87.5 - 108.0 MHz	
		Intermediate Frequency	10.7 MHz	
		Signal to Noise Ratio	61/58 dB	
		Frequency Response	60 - 10000 Hz	
	AM (MW)	Tuning Range	522 - 1611 kHz or 530 - 1610 kHz	
		Intermediate Frequency	450 kHz	
		Signal to Noise Ratio	35 dB	
		Frequency Response	100 - 1900 Hz	
[Amp]	Output Power	150W + 150W	200W + 200W	
	T.H.D	0.15%		
	Frequency Response	25 - 25000 Hz		
	Signal-to-noise ratio	80 dB		
[TAPE]	Tape Speed	4.75cm/sec		
	Wow Flutter	0.25% (MTT -111, JIS-WTD)		
	F.F/REW Time	120sec (C-60)		
	Frequency Response	125 - 8000Hz		
	Signal to Noise Ratio	43dB		
	Channel Separation	50dB(P/B)/45dB(R/P)		
	Erase Ratio	55dB (MTT-5511)		
[Speakers]	Model name	FE-886E	FE-986E	
	Type	3Way 3Speaker	3Way 3Speaker	
	Impedance	6Ω	6Ω	
	Frequency Response	50-20000Hz	45-20000Hz	
	Sound Pressure Level	86 dB/W (1m)	85 dB/W (1m)	
	Rated Input Power	150W	200W	
	Max. Input Power	300W	400W	
	Net Dimensions (W x H x D)	240X370X313mm	281X416X319.5mm	
Net Weight	6.09kg	7.8kg		

\* Designs and specifications are subject to change without notice.

REFERENCE



**LG Electronics Inc.**