



REFRIGERATOR- FREEZER

OWNER'S MANUAL

PLEASE
READ THIS OWNER'S MANUAL THOROUGHLY
BEFORE OPERATING AND KEEP IT HANDY
FOR REFERENCE AT ALL TIMES.



P/NO. 3828JD8499N



CONTENTS

INSTALLATION 3

FEATURES CHART 4

OPERATION 5

- Starting
- Temperature Control
- Ice Making
- Disassembly and Adjustment

SUGGESTIONS ON FOOD STORAGE 7

CLEANING 8

GENERAL INFORMATION 8

LAMP REPLACEMENT 9

IMPORTANT WARNINGS 9

REPLACEMENT OF DOOR OPENING TYPE (OPTION) 10

BEFORE CALLING FOR SERVICE 13

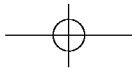
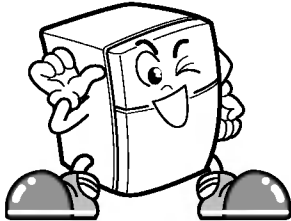

THIS REFRIGERATOR IS MANUFACTURED WITH GREAT CARE AND UTILIZES THE LATEST TECHNOLOGY.
 WE ARE CONFIDENT THAT YOU WILL BE FULLY SATISFIED WITH ITS PERFORMANCE AND RELIABILITY.
 BEFORE YOU START YOUR REFRIGERATOR, PLEASE READ THIS BOOKLET CAREFULLY. IT PROVIDES EXACT INSTRUCTIONS FOR INSTALLATION, OPERATION AND MAINTENANCE, AND ALSO SUPPLIES SOME USEFUL HINTS.

INSTALLATION

1. Avoid placing the unit near heat sources, direct sunlight or moisture.
2. There must be proper air circulation around your refrigerator to keep it operating efficiently. If your refrigerator is placed in a recessed area in the wall, allow at least 10 inches or greater clearance above the refrigerator and 2 inches or more from the wall.
 In the case the refrigerator needs to be placed on the carpet, it also should be elevated 1 inch from the floor.

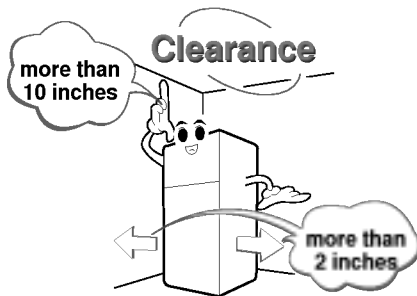

3. To avoid vibration, the unit must be level. If required, adjust the leveling screws to compensate for unevenness of the floor. The front should be slightly higher than the rear to aid in door closing. Leveling screws can be turned easily by tipping the cabinet slightly. Turn the leveling screws clockwise(↻) to raise the unit, counterclockwise(↻) to lower it.
4. Install this appliance between 10 °C and 43 °C. If the temperature around the appliance is too low or high, cooling ability may lessen.

NEXT

1. Clean your refrigerator thoroughly and wipe off all dust accumulated during shipping.
2. Install accessories such as ice cube bin, drawers, shelves, etc., in their proper places. They are packed together to prevent possible damage during shipment.
3. Connect the power supply cord (or plug) to the outlet. Don't double up with other appliances on the same outlet. The best solution is to have the refrigerator on a single-outlet circuit. Moreover, the appliance is so positioned that the plug is accessible.
4. Let your refrigerator run for 2 or 3 hours before putting food in it. Check the flow of cold air in the freezer compartment to ensure proper cooling. Your refrigerator is now ready for use.

FEATURES CHART

FREEZER COMPARTMENT

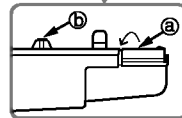
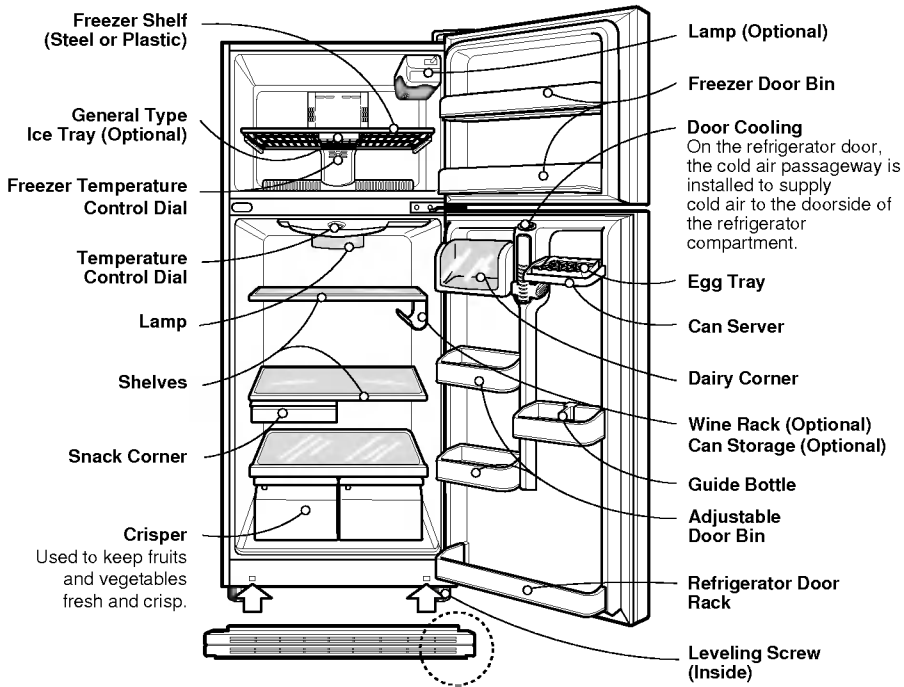

Kick Plate

1. Bend **a** down.
2. Push the kick plate toward the refrigerator.
3. **b** <Three protecting parts> should be beneath the bottom plate while pushing the kick plate.



OPERATION

STARTING

When your refrigerator is first installed, allow to run 2-3 hours to stabilize at normal operating temperature prior to filling it with fresh or frozen foods.

If operation is interrupted, wait 5 minutes before restarting.

TEMPERATURE CONTROL

REFRIGERATOR



REFRIGERATOR CONTROL

- Your refrigerator has two controls that let you regulate the temperature in the freezer and refrigerator compartments.
- Initially set the REFRIGERATOR CONTROL at 5 and the FREEZER CONTROL at 2. Leave it at this setting for 24 hours (one day) to stabilize. Then adjust the compartment temperature according to your desire.
- **REFRIGERATOR CONTROL** - 1, 2, 3, 4, 5, 6, 7, 8
The higher the number setting, the colder the refrigerator compartment will become.
- To turn the refrigerator off, turn the dial to the right to the word "off".

FREEZER

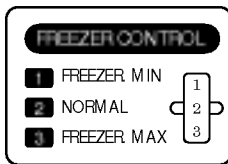

- **FREEZER CONTROL** - 1, 2, 3
Setting at 3, the freezer compartment becomes colder. But the refrigerator compartment becomes warmer because less cold air flows into the refrigerator compartment.

- **In cold weather** the unit operates less and the freezer compartment has a tendency to warm up. For a colder freezer, turn the FREEZER CONTROL to 3.

- **If you put a lot of food in the freezer or open its door frequently**, its temperature is apt to be somewhat higher. In this case, set the FREEZER CONTROL dial at 3 to cool it. Return the FREEZER CONTROL dial to the original position to cut down the consumption of energy.

- **In hot weather or if a lot of food is put in the refrigerator compartment**, the refrigerator compartment has a tendency to warm up. For a colder refrigerator, turn the FREEZER CONTROL to 1 to direct more cold air into the refrigerator compartment, and the REFRIGERATOR CONTROL to 6~8. If the FREEZER CONTROL is set at 3, the refrigerator compartment will not be cold enough.

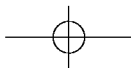



OPERATION

ICE MAKING (For General Type Ice Maker)

- If the tray is filled with water to the highest level, it will be difficult to remove ice cubes.
- For quick freeze, adjust the freezer dial to 3.



TO REMOVE ICE CUBES, TWIST THE TRAY.

- Do not warp the ice tray. Doing so may result in damage to the tray.
- To remove ice cubes easily, pour water on the tray or soak it into water before removing ice cubes.



DEFROSTING

- Defrosting takes place automatically.
- Defrosted water flows down to the evaporating tray which is located in the lower back side of the refrigerator and is evaporated automatically.

ADJUSTING THE CRISPER HUMIDITY CONTROL

You can control the amount of humidity in the moisture-sealed crispers. Adjust the control to any setting between MAX and MIN.

- MIN (open) lets moist air out of the crisper for best storage of fruits.
- MAX (closed) keeps moist air in the crisper for best storage of fresh, leafy vegetables.

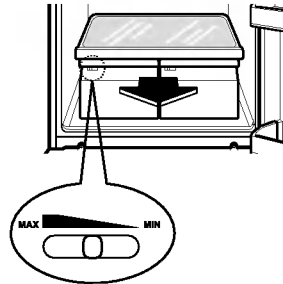

FREEZER SHELF

Remove the ice tray. Lift the front side of the shelf slightly and pull it forward to remove it.

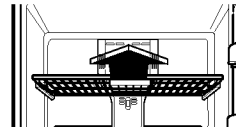

SNACK CORNER

While holding it with one hand, pull it forward slightly. Lift it slightly and pull it out.

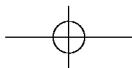
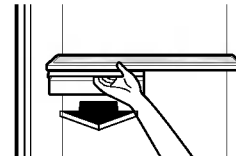



SUGGESTIONS ON FOOD STORAGE

STORING FOOD

- Store fresh food in the refrigerator compartment. How food is frozen and defrosted is an important factor in maintaining freshness and flavor.
- Do not store food which spoils easily at low temperatures, such as bananas, pineapples, and melons.
- Allow hot food to cool prior to storing. Placing hot food in the refrigerator could spoil other food, and lead to high electricity bills!
- When storing, wrap food in vinyl, or place in a covered container. This prevents moisture from evaporating, and helps food to keep its taste and nutritional value.
- Do not block air vents with food. Smooth circulation of chilled air keeps the refrigerator temperature even.
- Do not open the door frequently. Opening the door lets warm air enter the refrigerator, causing temperature to rise.
- To adjust the temperature control easily, do not store food near the temperature control dial.

FREEZER COMPARTMENT

- Do not store bottles in the freezer compartment - they may break when frozen.
- Do not refreeze food that has been defrosted. This causes loss of taste and nutritional value.
- When storing frozen food, like ice cream, for a long period, place it on the freezer shelf, not in the door rack.

REFRIGERATOR COMPARTMENT

- Avoid placing moist food on deep interior refrigerator shelves, it could freeze upon direct contact with chilled air. To avoid this, it is better to store food in a covered container.
- Always clean food prior to refrigeration. Vegetables and fruits should be washed and wiped, and packed food should be wiped clean, to prevent other food from spoiling.

NOTE

- If you keep the refrigerator in a hot and humid place, frequently opening the door or putting a lot of vegetables in it may cause dew to form. This has no effect on its performance. Remove the dew with a dry, dust-free cloth.
- If droplets form beneath the cover of the vegetable drawer, keep vegetables or fruits wrapped with plastic wrap.

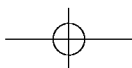

CLEANING

It is important that your refrigerator be kept clean to prevent undesirable odors. Spilled food should be wiped up immediately, since it may acidify and stain plastic surfaces if allowed to set.

Never use metallic scouring pads, brushes, coarse abrasive cleaners, or strong alkaline solutions on any surface.

Before you clean, however, remember that damp objects will stick or adhere to extremely cold surfaces. Do not touch frozen surfaces with wet or damp hands.

EXTERIOR - Use a lukewarm solution of mild soap or detergent to clean the durable finish of your refrigerator. Wipe with a clean, damp cloth and then dry.

INTERIOR - Regular cleaning of the interior and interior parts is recommended. Wash all compartments with a baking soda solution. Rinse and dry.

INTERIOR PARTS - Wash compartment shelves, door racks, storage trays, and magnetic door seals with a baking soda solution or a mild detergent and warm water. Rinse and dry.

WARNING

Always remove power cord from the wall outlet prior to cleaning in the vicinity of electrical parts (lamps, switches, controls, etc.) Wipe up excess moisture with a sponge or cloth to prevent water or liquid from getting into any electrical parts and causing an electrical short circuit. Do not use flammable or toxic cleaning liquids.

GENERAL INFORMATION

VACATION TIME

During average length vacations, you will probably find it best to leave the refrigerator in operation. Place freezable items in freezer for longer storage. When you plan to be away for an extended period,

- Disconnect the power cord or set refrigerator Dial knob to off position.
- Remove all food and other items from the unit.
- Clean the unit thoroughly.
- Leave the shelves in the unit to discourage children from playing in the unit.
- Leave the doors open and block them to ensure that they **cannot be closed**.

POWER FAILURE

Most power failures are corrected in an hour or two and will not affect your refrigerator temperatures. However, you should minimize the number of door openings while the power is off. During power failures of longer duration, place a block of dry ice on top of your frozen packages.



- Dry ice is very cold! Do not allow it to touch bare skin. It is well below 0 °F and will cause immediate frostbite and damage to the skin and other tissue.
- Dry ice is frozen carbon dioxide. Use only in a well ventilated area. As the ice releases carbon dioxide vapor, it could cause light-headedness, fainting, suffocation, or death.

IF YOU MOVE

Remove or securely fasten down all loose items inside the refrigerator. To avoid damaging the leveling screws, turn them all the way into the base.

ANTI-CONDENSATION PIPE

The outside wall of the refrigerator cabinet may sometimes get warm, especially just after installation. Don't be alarmed. This is due to the anti-condensation pipe, which pumps hot refrigerant to prevent sweating on the outer cabinet wall.

Anti-Condensation Pipe

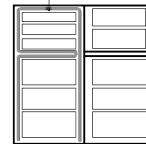

LAMP REPLACEMENT

FREEZER LAMP

1. Unplug the power cord from the outlet.
2. Remove the room lamp lid by taking down while pulling it forward with your hand after inserting finger into the inside hole as shown in the figure at right.
3. Remove the lamp by turning it counterclockwise and replace new one.
4. Assemble in reverse order of disassembly. Replacement bulb must be the same specification as original.

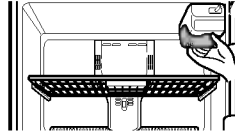

REFRIGERATOR LAMP

1. Unplug the power cord from the outlet.
2. Remove refrigerator shelves.
3. Upper Refrigerator Lamp.
Release the hooks on both ends of the lamp shield and pull the shield downward to remove it.
4. Turn the lamp counterclockwise.
5. Assemble in reverse order of disassembly. Replacement bulb must be the same specification as original. (Max 40 W)

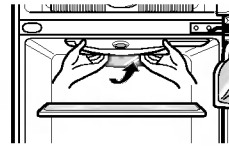

IMPORTANT WARNINGS

DO NOT USE AN EXTENSION CORD

If possible, connect the refrigerator to **its own individual electrical outlet** to prevent it and other appliances or household lights from causing an overload that could cause a power outage.

POWER CORD REPLACEMENT

If the supply cord is damaged, it must be replaced by the manufacturer or its service agent or a similarly qualified person in order to avoid a hazard.

CHILD ENTRAPMENT WARNING

DANGER : Risk of child entrapment. Before you throw away your old refrigerator or freezer:

Take off the doors.
Leave the shelves in place so that children may not easily climb inside.

ABOUT GROUNDING (EARTHING)

In the event of an electric short circuit, grounding (earthing) reduces the risk of electric shock by providing an escape wire for the electric current.

In order to prevent possible electric shock, this appliance must be grounded.

Improper use of the grounding plug can result in an electric shock. Consult a qualified electrician or service person if the grounding instructions are not completely understood, or if you have doubts on whether the appliance is properly grounded.

**This appliance must be grounded (earthed).
DON'T WAIT! DO IT NOW!**

NEVER STORE EXPLOSIVES AND CHEMICALS

REPLACEMENT OF DOOR OPENING TYPE (OPTION)

PRECAUTION

1. Before replacing the door opening type, first of all, you should take out of food and accessories like shelves or trays, which are not fixed in the refrigerator.
2. Use a '+' Driver, Bolt Driver, Torque Wrench or Spanner to fix or remove the bolt.
3. Be careful not to tip over the refrigerator in disassembling or assembling the Lower Hinge and the Adjustable Screw Asm. Don't lay the refrigerator down when working it will cause it to malfunction.
4. Be careful not to drop the door in disassembling or assembling the freezer or the refrigerator door.
5. This refrigerator, according to the installation position or user's preference can have the door opening from the right or left.

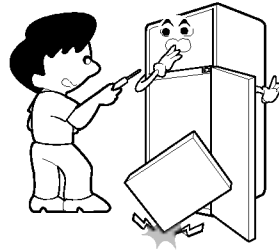

HOW TO REPLACE THE DOOR OPENING LEFT TO RIGHT (when converting from the left-opening type to right opening type)

1. Removing Freezer Door

- Separate the top hinge cover (1).
- Loosen 3 screws and separate off the top hinge (2).
- Lift the freezer door (3) slightly and separate it.
- Separate the cover (4) using a (-)-screwdriver and fix it on the right.
- Loosen the screw (5), separate off the stopper (6), and fix it on the left (on the opposite side).
- Separate the cover (7) using a (-)-screwdriver and fix it on the right.
- Separate off (8).

2. Removing Refrigerator Door

- Loosen the screw (9) and separate off the middle hinge (10).
- Lift the door (11) slightly and separate it.
- Take off the Grille (12).
- Loosen the screw (14) and fix the pin (15) and the cap (16) into the hole on the left.
- Remove the screw (17).
- Loosen the screw (18). Separate the bottom hinge (20) and fix it on the left.
- Fix the screw (17) on the right.
- Loosen the screw (22) and fix the stopper (23) on the left.

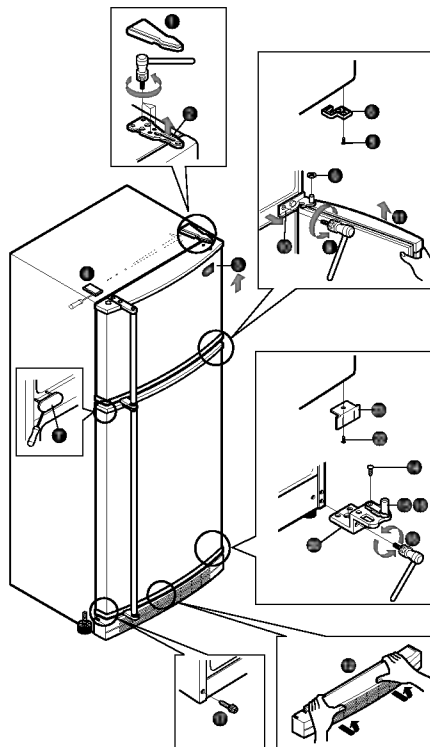

REPLACEMENT OF DOOR OPENING TYPE (OPTION)

3. Moving Freezer Handle

- Loosen 2 screws (4).
- Loosen the screws (1) (two on the top and two on the bottom), take off the handle (2), and reverse the handle(2), and attach it on the right.
- Attach the removed 2 screws (4) on the left.
- Attach the cap (3) on the top on the opposite side.

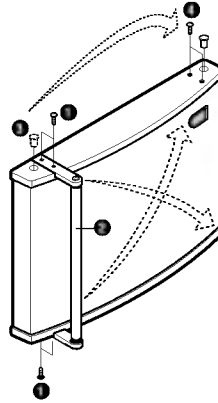

4. Moving Refrigerator Handle

- Loosen 2 screws(8).
- Loosen the screws(5) (two on the top and two on the bottom), take off the handle(6), and attach it on the right.
- Attach the removed 2 screws (8) on the left.
- Attach the cap(7) on the top on the opposite side.

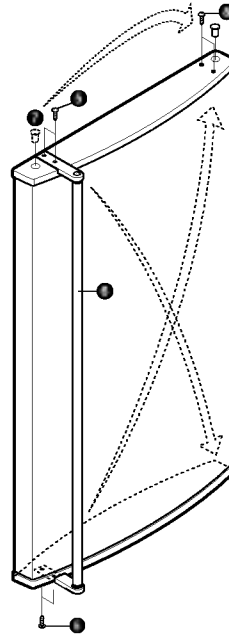

REPLACEMENT OF DOOR OPENING TYPE (OPTION)

5. Attaching Refrigerator Door

- Fix the base Grille (1).
- Fix the door (3) to the bottom hinge pin.
- Fix the middle hinge (4) on the opposite side with the screw (5).

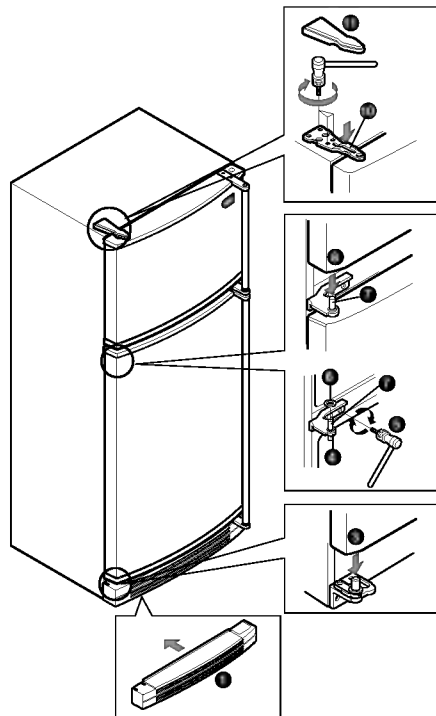

6. Attaching Freezer Door

- Place the washer (6) to the middle hinge pin (7).
- Place the door (8) so that it fit (5) into the middle hinge pin (7).
- Fix the top hinge(10) with screws.
- Fix top hinge cover (11).

7. After Completing the job

- Make sure that the four corners of the door gasket are not folded. It is recommended to apply a small amount of silicon grease on them.
- Adjust the leveling screw on the bottom to the highest level so that the front side of the refrigerator is higher than the rear side.
- If you need assistance after switching the direction of the door opening as shown above, call a service center.

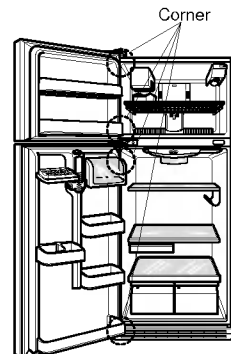

BEFORE CALLING FOR SERVICE

SERVICE CALLS CAN OFTEN BE AVOIDED!
IF YOU FEEL YOUR REFRIGERATOR IS NOT OPERATING PROPERLY, CHECK THESE POSSIBLE CAUSES FIRST:

| PROBLEM | POSSIBLE CAUSES |
|--|--|
| REFRIGERATOR DOES NOT OPERATE | <ul style="list-style-type: none"> ● Has a house fuse blown or circuit breaker tripped? ● Has the power cord plug been removed or loosened from the electrical wall outlet? |
| REFRIGERATOR OR FREEZER COMPARTMENT TEMPERATURE TOO WARM | <ul style="list-style-type: none"> ● Temperature control not set on proper position. ● Appliance is placed close to wall or heat source. ● Warm weather-frequent door openings. ● Door is not closed entirely. ● Door left open for a long time. ● Large amount of foods are kept in the refrigerator. |
| ABNORMAL NOISE(S) | <ul style="list-style-type: none"> ● Refrigerator is installed in a weak or uneven place or leveling screw needs adjusting. ● Unnecessary objects placed in the back side of the refrigerator. |
| REFRIGERATOR HAS ODOR | <ul style="list-style-type: none"> ● Foods with strong odors should be tightly covered or wrapped. ● Interior needs cleaning. |
| DEW FORMS ON THE CABINET SURFACE | <ul style="list-style-type: none"> ● Not unusual during periods of high humidity. ● Door may have been left ajar. |

