

Single Package Air Conditioners **OWNER'S MANUAL**

- Please read carefully and thoroughly this manual before operating this unit.
- Contact the authorized SVC man for repair or maintenance of this unit.
- Contact the installer for installation of this unit.
- The appliance is not intended for use by young children or infirm persons without supervision.
- Young children should be supervised to ensure that they do not play with the appliance.

Prior to installation, this air-conditioning unit must be submitted for approval by the utility service which provides electricity (EN 61000-3 Norm).

P/No.: 3828A20228G

File Tab Position: 3

Rev. No.: 1

Safety Precautions

Important Safety Precautions3
 Operation Precautions4



FOR YOUR RECORDS

Write the model and serial numbers here for the unit:

Model # _____ **Serial #** _____

You can find them on a label on the side of unit.

Dealer's Name _____

Date Purchased _____

Operating Instructions

How to operate the Unit5



READ THIS MANUAL

- Inside you will find many helpful hints on how to use and maintain your air conditioner properly. Just a little preventive care on your part can save you a great deal of time and money over the life of your air conditioner.
- You'll find many answers to common problems in the chart of **Troubleshooting Tips** first, you may not need to call for service at all.

Care and Maintenance

Care and Maintenance6
 Operation Tips8



CAUTION

- Contact the authorized Service technician for repair or maintenance of this unit.
- Contact the installer for installation of this unit.
- The air conditioner is not intended for use by young children or infirm persons without supervision.
- Young children should be supervised to ensure that they do not play with the air conditioner.

Troubleshooting tips

Before You
 Call For Service9
 Service Centers10

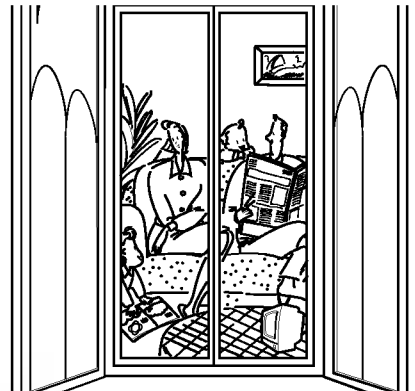

Important safety precautions

Read all instructions before using.

To prevent injury to the user or other people and property damage, the following instructions must be followed.

- Incorrect operation due to ignoring of instruction will cause harm or damage, the seriousness is classified by the following indications.



WARNING : This symbol indicates the possibility of death or serious injury.



CAUTION : This symbol indicates the possibility of injury or damage to properties only.

- Meanings of symbols used in this manual are as shown below.



Be sure not to do.



Be sure to follow the instruction.

Installation precautions



WARNING

- **Do not install, remove and re-install the unit by yourself.**
Improper installation will cause water leakage, electrical shock, or fire. Please consult authorized dealer or specialist for the installation work.



CAUTION

Please confirm the following important points during installing.



- **This air conditioner must be grounded.**
It may cause electrical shock if grounding is not perfect.



- **Condensed water should be fully drained.**
If the drainage route is incomplete, water may drop from the unit.



- **Do not install the unit at place where leakage of gas may occur and/or in an explosive atmosphere.**
In case of gas leakage the gas may accumulate in the unit and it may cause fire ignition.



- **Install a ground fault interrupter depending on the place where the air conditioner is to be installed. (humid place, etc.)**
If the ground fault interrupter is not installed, it may cause an electric shock.



- **Confirm drainage piping is connected properly.**
If it is not connected perfectly, it may cause water leakage.
(See INSTALLATION & MAINTENANCE INSTRUCTIONS)

Operation precautions

WARNING

Do not insert hands through Discharge Grille when the air conditioner is operating.

- It will cause an injury by the fan.

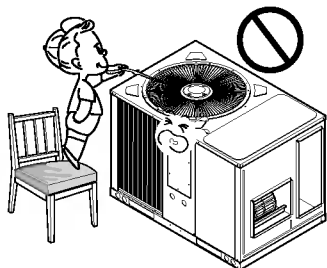

Do not step on the unit and do not put anything on it.

- It may cause an injury.

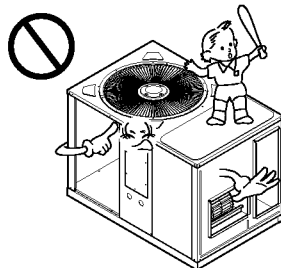

Do not operate with wet hand.

- It will cause electrical shock.



When the unit is not going to be used for a long time, turn off the circuit breaker.

- If not, dirt may collect and cause a fire.

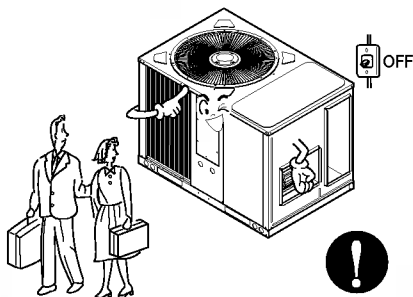

When an abnormality (smell of burning, etc) occurs, stop the air conditioner and turn off the circuit breaker.

- If the unit continues to operate in an abnormal condition, it may cause fire, damage, etc. In this case, consult your dealer.

Repair or relocation should not be done by the customer.

- If these are done incorrectly, it may cause a fire, electric shock, injury. Consult your dealer.

How to operate the Unit(with mechanical thermostat)



Cooling Operation

- 1 Move the FAN switch back to the "AUTO" position.
 - With the "FAN" switch in the "ON" position, Indoor fan motor shall operate continuously regardless of system switch position.

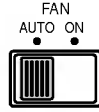

- 2 Move the system switch to the "COOL" position.

This unit has "time delay PCB" so there is 3-minute(± 45 seconds) delay before compressor start.

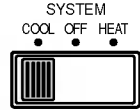

- 3 Set the temperature lower than the room temperature.

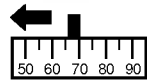

- 4 Move the system switch to the "OFF" position in order to stop cooling operation.

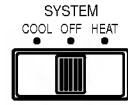

Electric Heater Operation (Electric Heater is an option)

- 1 Move the FAN switch to the "AUTO" position.
 - With the "FAN" switch in the "ON" position, Indoor fan motor shall operate continuously regardless of system switch position.

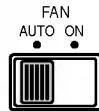

- 2 Move the system switch to the "HEAT" position.

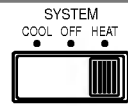

- 3 Set the temperature upper than the room temperature.

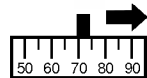

- 4 Move the system switch to the "OFF" position in order to stop heating operation.

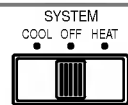

Care and maintenance

CAUTION: Before performing any maintenance, turn off the main power to the system.

You can do some of the periodic maintenance for your unit yourself; this includes, cleaning unit cabinet, clearing the condenser coil, and conducting a general unit inspection on a regular basis.

WARNING

Before removing access panels to service unit, disconnect power supply. Failure to disconnect power before attempting any servicing can result in severe injury or death.

Filter

The units are shipped without a filter and is the responsibility of the installer to secure a filter in the return air ductwork.

Filter must always be used and must be kept clean.

When filters become dirt laden, insufficient air will be delivered by the blower, decreasing your units efficiency and increasing operating costs and wear-and-tear on the units and controls.

Filters should be checked monthly especially since the unit may be used for both heating and cooling.

Condenser coil

Unfiltered air circulates through the unit's condenser coil and can cause the coil's surface to become clogged with dust, dirt, etc.. To clean the coil, vertically (i.e., along the fins) stroke the coil surface with a soft bristled brush.

Keep all vegetation away from the condenser coil area.

Maintenance Performed by Serviceman-Cooling Season

To keep your unit operating safely and efficiently, the manufacturer recommends that a qualified serviceman check the entire system at least once each year, or more frequently if conditions warrant. Your serviceman may examine these areas of your unit:

1. Filter (for cleaning)
2. Motors and drive system components
3. Condenser coils (for cleaning)
4. Safety Controls (for mechanical cleaning)
5. Electrical components and wiring (for possible replacement or connection tightness)
6. Condensate drain (for cleaning)
7. Inspect the unit duct connections to ensure they are physically sound and sealed to the unit casing.
8. Inspect the unit mounting support to see that it is sound.
9. Inspect the unit to ensure there is no obvious deterioration.

Maintenance Performed By Serviceman-Heating Season

Complete the unit inspections and service routines described below at the beginning of each heating season.

- Inspect the controller panel wiring to verify that all electrical connections are tight and that wire insulation is intact.

When the air conditioner is not going to be used for a long time.

When air conditioner is not going to be used for a long time.

- 1 Operate the air conditioner on Air circulation mode for 2 to 3 hours.

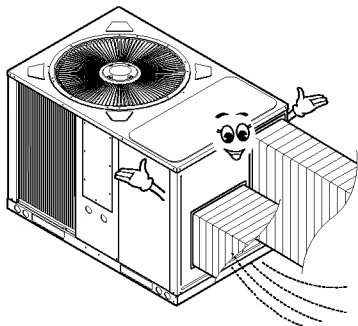

- This will dry out the internal parts.

- 2 Turn off the circuit breaker.



CAUTION

Turn off the circuit breaker when the air conditioner is not going to be used for a long time. Dirt may collect and may cause a fire.

When the air conditioner is to be used again.

Check that the air inlet and outlet of the indoor/outdoor unit are not blocked.

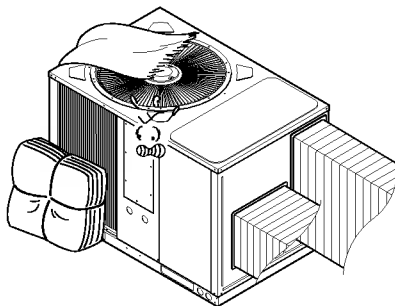

Helpful information

The air filters and your electric bill.
If the air filters become clogged with dust, the cooling capacity will drop, and 6% of the electricity used to operate the air conditioner will be wasted.

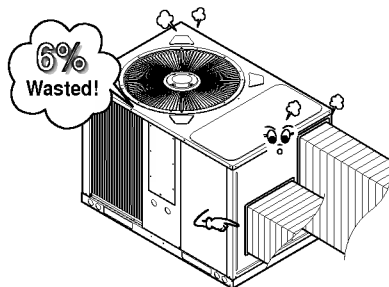

Operation Tips

Do not overcool the room.

This is not good for your health and wastes electricity.

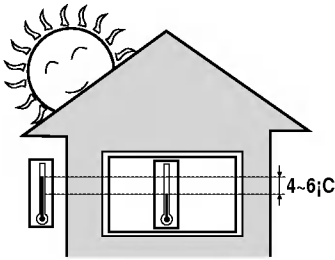

Make sure that the doors and windows are shut tight.

Avoid opening doors and windows as much as possible to keep the cool air in the room..

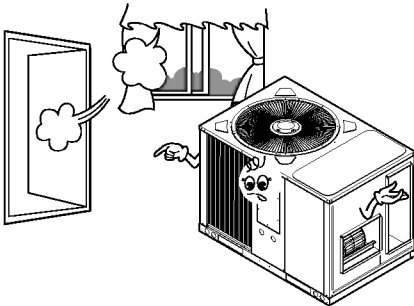

Keep blinds or curtains closed.

Do not let direct sunshine enter the room when the air conditioner is in operation.

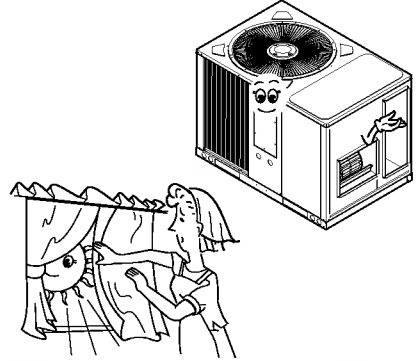

Ventilate the room occasionally.

Since windows are kept closed, it is a good idea to open them and ventilate the room now and then.

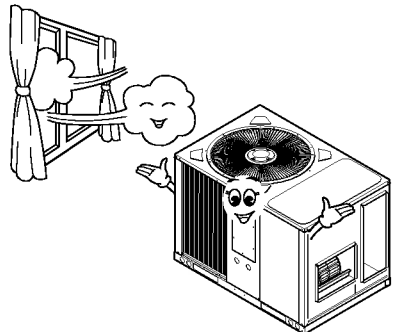

Before you call for service...



Troubleshooting Tips! Save time and money!

Check the following points before requesting repairs or service.... If the fault persists, please contact your dealer or service center.

Does not operate.

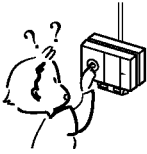

- Has the fuse blown or has the circuit breaker been tripped?

Air conditioner does not operate for about 3 minutes when restarted.

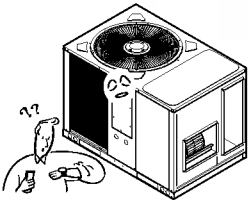

- This is the Protection device of the air conditioner .
- Wait about three minutes and operation will begin.

The room has a peculiar odor.

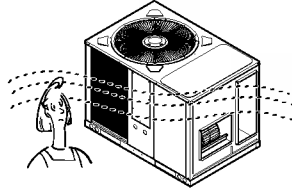

- Check that this is not a damp smell exuded by the walls, carpet, furniture, or cloth items in the room.

Does not cool or heat effectively.

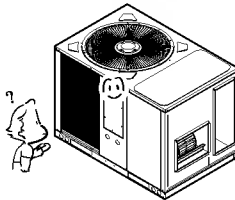

- The room may have been very hot when the air conditioner was first turned on. Allow time for it to cool down.
- Has the setting temperature been set incorrectly?
- Are the unit's air inlet or outlet vents obstructed?

It seems that condensation is leaking from the air conditioner.

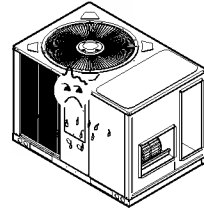

- Condensation occurs when the airflow from the air conditioner cools the warm air.

The air conditioner operation is noisy.

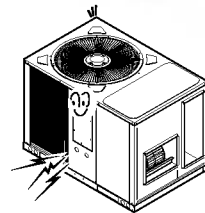

- For a noise that sounds like water flowing.
-This is the sound of freon flowing inside the air conditioner unit.

Product Specifications/Service Centers

Safety Precautions

Details of LG serial No.

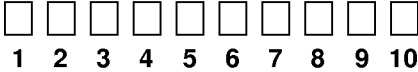

Code	Detail	Code of Model	Meaning
1	Year	0~9 (Digit)	The last digit of year ex) 1997 → 7, 2000 → 0
2,3	Month	01~12 (Digit)	Month ex) March → 03, August → 08
4	Nation	A~Z (Alphabet)	Where manufactured ex) K → Korea, C → China
5	Product	A~Z (Alphabet)	ex) A → Airconditioner
6~10	Serial No.	0~9 (Digit)	Production Quantity

Operating Instructions

■ Service Centers

H. G. IBRAHIM SHAKER COMPANY, LTD.
SERVICE CENTER

- * JEDDAH : P. O. BOX 50, JEDDAH 21411 KINGDOM OF SAUDI ARABIA
TEL NO. : 6422952 / 6425527
- * RIYADH : P. O. BOX 15, RIYADH 11411 KINGDOM OF SAUDI ARABIA
TEL NO. : 4020570
- * AL-KHOBAR : P. O. BOX 78, AL-KHOBAR 31952 KINGDOM OF SAUDI ARABIA
TEL NO. : 8943714

Care and Maintenance

In case of parts being disordered,
please contact with SVC center:
and check the replacement parts code.

Troubleshooting Tips