



Washing Machine

OWNER'S MANUAL

WD-6516(0~9)SP WD-6516(0~9)NP
WD-8016(0~9)SP WD-8016(0~9)NP
WD-1016(0~9)SP WD-1016(0~9)NP

Thank you for buying a
LG Fully Automatic Washing machine.
Please read your owner's manual carefully, it provides
instructions on safe installation, use and maintenance.
Retain it for future reference.
Record the model and serial numbers of your washing machine.

P/No.: 3828EN3808W

Product Feature



- **More economical by Intelligent Wash System**
Intelligent Wash System detects the amount of load and water temperature, and then determines the optimum water level and washing time to minimize energy and water consumption.

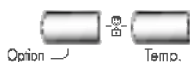

- **Child-Lock**
The Child-Lock system has been used to prevent children from pressing any button to change the program during operation.



- **Low noise speed control system**
By sensing the amount of load and balance, it evenly distributes load to minimize the spinning noise level.

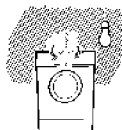

- **Auto Restart**
If the washing machine is turned off by a power failure, it will restart automatically from the position it stopped at adjusting accordingly.

Contents

Warnings.....	3
Specification	4
Installation.....	5
Care before washing.....	11
Adding detergent	12
Function	13
How to use washer	14
Maintenance	21
Troubleshooting guide	24

Warnings

READ ALL INSTRUCTIONS BEFORE USE

▲ WARNING!

For your safety, the information in this manual must be followed to minimize the risk of fire or explosion, electric shock, or to prevent property damage, personal injury, or loss of life.

IMPORTANT SAFETY INSTRUCTIONS

WARNING : To reduce the risk of fire, electric shock, or injury to persons when using the washer, follow basic precautions, including the following:

- Do not install or store the washer where it will be exposed to the weather.
- Do not tamper with controls.
- Do not repair or replace any part of the washer or attempt any servicing unless specifically recommended in the user-maintenance instructions or published user-repair instructions that you understand and have the skills to carry out.
- Keep the area underneath and around your appliances free of combustible materials such as lint, paper, rags, chemicals, etc.
- Close supervision is necessary if this appliance is used by or near children.
Do not allow children to play on, with, or inside this or any other appliance.
- Do not leave the washer door open.
An open door could entice children to hang on the door or crawl inside the washer.
- Never reach into washer while it is moving. Wait until the drum has completely stopped.
- The laundry process can reduce the flame retardant of fabrics.
- Do not wash or dry articles that have been cleaned in, washed in, soaked in, or spotted with combustible or explosive substances (such as wax, oil, paint, gasoline, degreasers, dry-cleaning solvents, kerosene, etc.) which may ignite or explode.
- To avoid such a result, carefully follow the garment manufacturer's wash and care instructions.
- Do not slam the washer door closed or try to force the door open when locked. This could result in damage to the washer.
- To minimize the possibility of electric shock, unplug this appliance from the power supply or disconnect the washer at the household distribution panel by removing the fuse or switching off the circuit breaker before attempting any maintenance or cleaning.
- Never attempt to operate this appliance if it is damaged, malfunctioning, partially disassembled, or has missing or broken parts, including a damaged cord or plug.

SAVE THESE INSTRUCTIONS

GROUNDING INSTRUCTIONS

This appliance must be grounded. In the event of malfunction or breakdown, grounding will reduce the risk of electric shock by providing a path of least resistance for electric current. This appliance is equipped with a cord having an equipment-grounding conductor and grounding plug. The plug must be plugged into an appropriate outlet that is properly installed and grounded in accordance with all local codes and ordinance.

- Do not use an adapter or otherwise defeat the grounding plug.
- If you don't have the proper outlet, consult an electrician.

WARNING : Improper connection of the equipment-grounding conductor can result in risk of electric shock. Check with a qualified electrician or serviceman if you are in doubt as to whether the appliance is properly grounded. Do not modify the plug provided with the appliance - if it does not fit the outlet, have a proper outlet installed by a qualified electrician.

S pecification

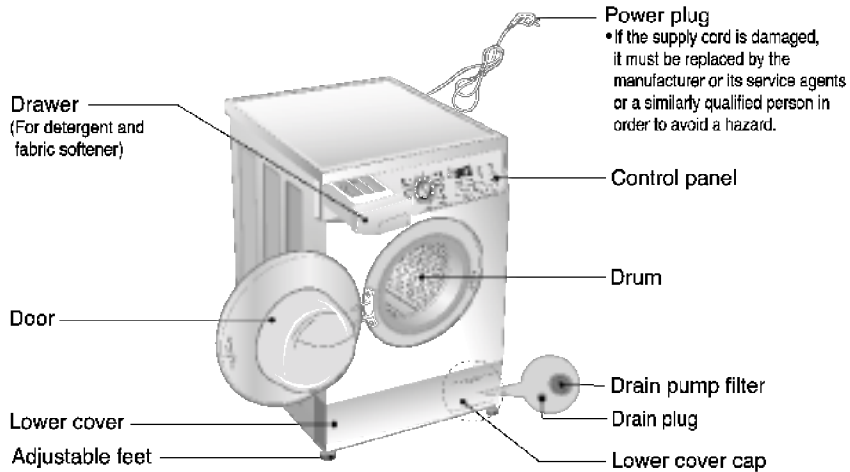

	WD-10160-9SP/80160-9SP/65160-9SP	WD-10160-9NP/80160-9NP/65160-9NP
Name	Front loading washing machine	
Power supply	220-240V~, 50Hz	
Size	600mm(W) × 360mm(D) × 850mm(H)	600mm(W) × 440mm(D) × 850mm(H)
Weight / Max. Watt	55kg / 2100W	60kg / 2100W
Water consumption	42 ℓ	60 ℓ
Permissible water Pressure	0.3 - 10kgf/cm ² (30~1000kPa)	
Spin Speed	No Spin / 400 / 600 / 800	[WD-8016(0~9)SP/8016(0~9)NP] No Spin / 400 / 800 / 1000 [WD-1016(0~9)SP/1016(0~9)NP] No Spin / 400 / 500 / 650 [WD-6516(0~9)SP/6516(0~9)NP]

■ Accessories

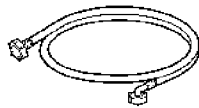

Inlet hose 1EA



Spanner

Installation

Install or store where it will not be exposed to temperatures below freezing or exposed to the weather. Properly ground washer to conform with all governing codes and ordinances. The base opening must not be obstructed by carpeting when the washing machine is installed on a carpeted floor.

In countries where there are areas which may be subject to infestation by cockroaches or other vermin, pay particular attention to keeping the appliance and its surroundings in clean condition at all times. Any damage which may be caused by cockroaches or other vermin will not be covered by the appliance guarantee.

■ Transit bolts

The appliance is fitted with transit bolts to prevent internal damage during transport.

■ Removing transit bolts

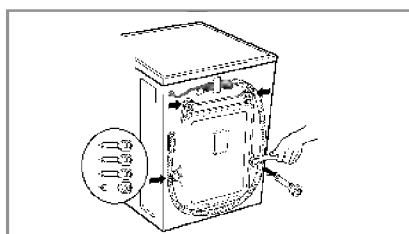
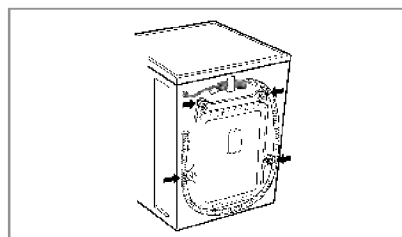

1. To prevent internal damage during transport, the special 4 bolts are locked. Before operating the washer, remove the bolts along with the rubber bungs.

3. Take out the 4 bolts along with the rubber bungs by slightly twisting the bung. Keep the 4 bolts and the spanner for future use.

• If they are not removed, it may cause heavy vibration, noise and malfunction.

• Whenever the appliance is transported, the transit bolts must be refitted.

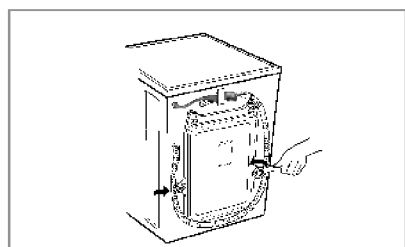

2. Unscrew the 4 bolts with the spanner supplied.

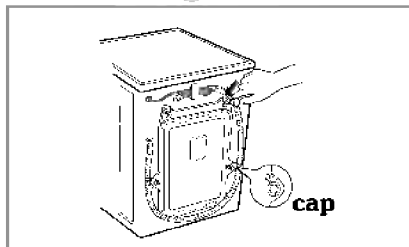

4. Close the holes with the caps supplied.

Installation

■ Installation place requirement

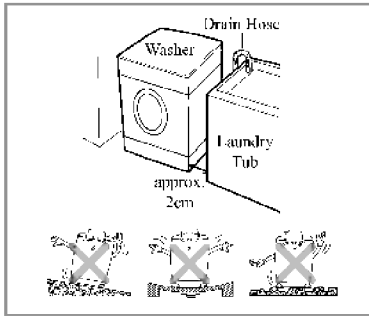

Level floor :

Allowable slope under entire washer is 1°

Power outlet :

Must be within 1.5 meters of either side of location of washer. Do not overload the outlet with more than one appliance.

Additional Clearance :

For wall, door and floor modeling is required.
(10cm : rear /2cm:right & left side)

Do not place or store laundry products on top of washer at any times.

They can damage the finish or controls.

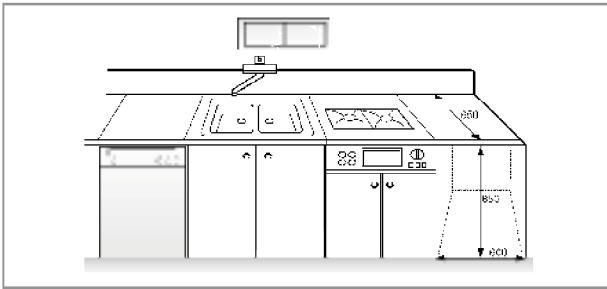

■ BS Plug Safety Details (For U.K. User)

IMPORTANT

THE WIRES IN THIS MAINS LEAD ARE COLOURED IN ACCORDANCE WITH THE FOLLOWING CODE:

GREEN AND YELLOW: EARTH

BLUE: NEUTRAL

BROWN: LIVE

This appliance must be earthed

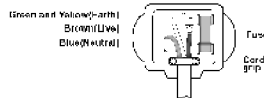

As the colours of the wires in the mains lead of this apparatus may not correspond with the coloured markings identifying the terminals in your plug, proceed as follows:

The wire which is coloured Green and Yellow must be connected to the terminal in the plug which is marked with the letter E or by the earth symbol (⊕) or coloured Green or Green and Yellow.

The wire which is coloured Blue must be connected to the terminal which is marked with the letter N or coloured Black.

The wire which is coloured Brown must be connected to the terminal which is marked with the letter L or coloured Red.
If a 13 amp (BS 1363) plug is used, fit a 13 amp BS 1362 fuse.

Installation

■ Electrical connection

1. Do not use an extension cord or double adapter.
 2. If the supply cord is damaged, it must be replaced by the manufacturer or its service agents or similarly qualified person in order to avoid a hazard.
 3. Always unplug the machine and turn off the water supply after use.
 4. Connect the machine to an earthed socket in accordance with current wiring regulations.
 5. The appliance must be positioned so that the plug is easily accessible.
- Repairs to the washing machine must only be carried out qualified personnel. Repairs carried out by inexperienced persons may cause injury or serious malfunctioning. Contact your local service center
 - Do not install your washing machine in rooms where temperatures below freezing may occur. Frozen hoses may burst under pressure. The reliability of the electronic control unit may be impaired at temperatures below freezing point.
 - If the appliance is delivered in the winter months and temperatures are below freezing : Store the washing machine at room temperature for a few hours before putting it into operation.

■ Washing Machine is to be connected to the water mains using new hose-sets and that old hose-sets should not be used.

■ Connecting water supply hose

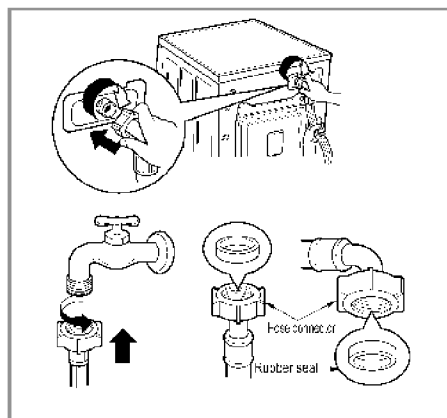

- ▶ Water supply pressure must be between 30kPa and 1000kPa (0.3~10kgf/cm²)
- ▶ Don't strip or crossthread when connecting Inlet hose to the valve.
- ▶ If the water supply pressure is more than 1000kPa, a decompression device should be installed.
- Two rubber seals are supplied with the water inlet hoses these are in order to prevent water leaks.
- Check water tightness of washing machine connections by turning the tap completely on.
- Periodically check the condition of the hose and replace the hose if necessary.
- Make sure that there is no kink on the hose and that it is not crushed.

Installation

■ Normal Tap without thread & screw type inlet hose

1. Unscrew the fixing screw to attach the tap.
2. Push the connector up till the rubber packing is in tight contact with the tap. Then tighten the 4 screws.
3. Push the water supply hose vertically upwards so that the rubber packing within in the hose can adhere completely to the tap and then tighten it by screwing it to the right.

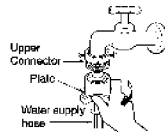
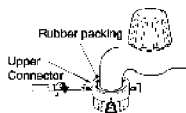
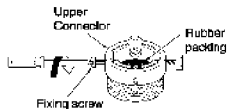

■ Normal Tap without thread & one touch type inlet hose (Single inlet models)

1. Untighten the upper connector screw.
2. Push the upper connector up till the rubber packing is in tight contact with the tap. Then tighten the 4 screws.
3. Connect the water supply hose to the middle connector, pushing the plate down.

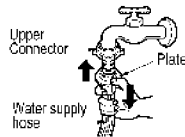
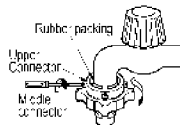
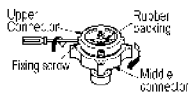

• In case the diameter of the tap is large remove the guide plate.

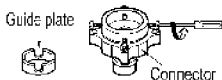

- Turn the middle connector not to have water leaked.
- Make sure that the rubber seal is inside the hose connector.

- To separate the water supply hose from the middle connector shut off the tap. Then pull the inlet hose down, pushing the plate down.

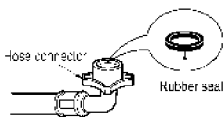

Used the horizontal tap	
Horizontal tap	
Extension tap	
Square tap	

- Your machine comes with only cold water connection.
- Make sure that there are no kinks in the hose and that it is not crushed.

Installation

This equipment is not designed for maritime use or for use mobile installations such as caravans, aircraft etc.

Turn off the stopcock if the machine is to be left for any length of time (e.g. holiday), especially if there is no floor drain(gully) in the immediate vicinity.

When disposing of the appliance, cut off the mains cable, and destroy the plug Disable the door lock to prevent young children being trapped inside.

Packaging material (e.g. Films, Styrofoam) can be dangerous for children. There is a risk of suffocation ! Keep all packaging well away from children

■ Installation of drain hose

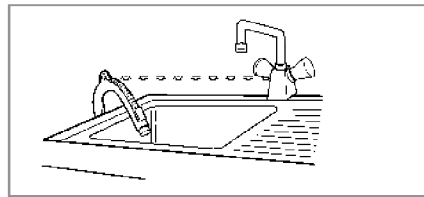
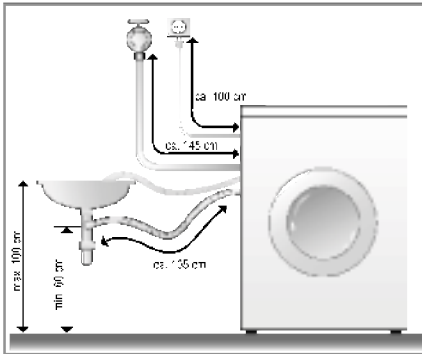

- When installing the drain hose sink, secure it tightly with a string.
- Proper securing of the drain hose will protect the floor from damage due to water leakage.

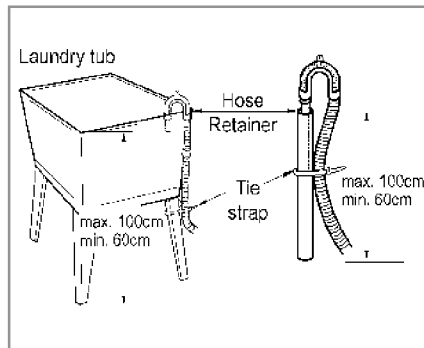
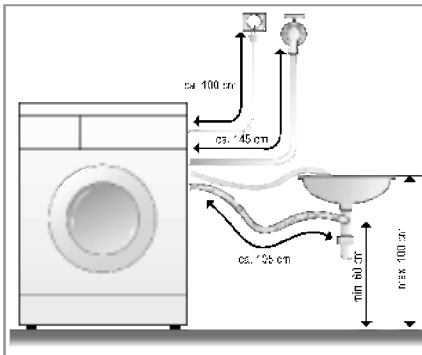

- The drain hose should not be placed higher than 100 cm above the floor.
- Proper securing of the drain hose will protect the floor from damage due to water leakage.
- When the drain hose is too long, do not force back into the washer. This will cause abnormal noise.

Installation

■ Level adjustment

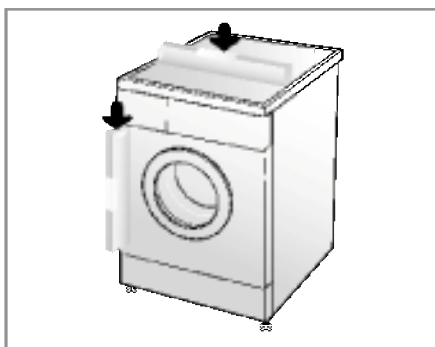

1. Adjusting the washing machine level properly prevents excessive noise and vibration.
Install the appliance on a solid and level floor surface, preferably in a corner of the room.

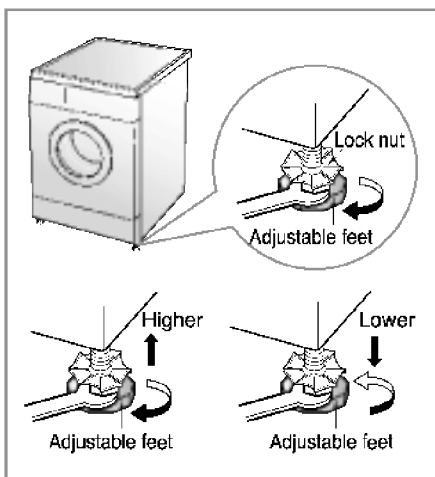

2. If the floor is uneven, adjust the adjustable feet as required. (do not insert pieces of wood etc. under the feet) Make sure that all four feet are stable and resting on the floor and then check that the appliance is perfectly level. (use a spirit level)
1 After the washer is level, tighten the lock nuts up towards of the base of the washer. All lock nuts must be tightened.

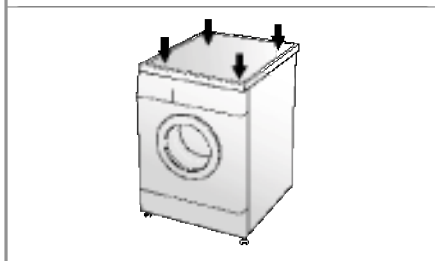

- ※ **Diagonal Check**
*When pushing down the edges of the washing machine top plate diagonally, the machine should not move up and down at all. (Please, check both of two directions)
If machine rocks when pushing the machine top plate diagonally, adjust the feet again.*

Care before washing

■ Caring before washing

1. Care Labels

Look for a care label on your clothes. This will tell you about the fabric content of your garment and how it should be washed.

2. Sorting

To get the best results, Sort clothes into loads that can be washed with the same wash cycle. Water temperature and spin speed and different fabrics need to be washed in different ways. Always sort dark colors from pale colors and whites. Wash separately as dye and lint transfer can occur causing discoloration of white etc. If possible, do not wash heavily soiled items with lightly soiled one.

Soil (Heavy, Normal, Light)

Color (White, Lights, Darks)

Lint (Lint producers, Collectors)

Separate clothes according to amount of soil.

Separate white fabrics from colored fabrics.

Wash lint producers and lint collectors separately.

3. Caring before loading

- Combine large and small items in a load. Load large items first. Large items should not be more than half the total wash load.
Do not wash single items. This may cause an out-of-balance load. Add one or two similar items.

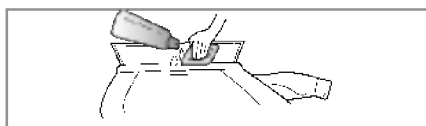
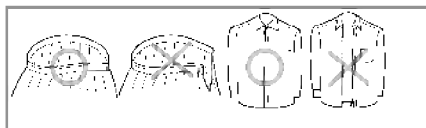

- Check all pockets to make sure that they are empty. Items such as nails, hair clip, matches, pens, coins and keys can damage both your washer and your clothes.
- Close zippers, hooks and strings to make sure that these items don't snag on other clothes.
- Pre treat dirt and stains by brushing a little detergent dissolved in water onto stains like collars and cuffs to help shift dirt.

A dding detergent

■ Adding detergent and fabric softener

1. The Dispenser Drawer

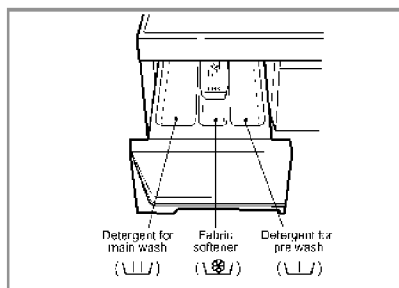

- Main wash only
- Pre Wash + Main Wash

2. Adding Fabric Softener

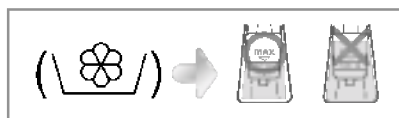

- Do not exceed the maximum fill line. Overfilling can cause early dispensing of the fabric softener which could stain clothes.
- Do not leave the fabric softener in the detergent drawer for more than 2 days. (Fabric softener could harden)
- Softener will automatically be added during the last rinse cycle.
- Do not open the drawer when water is supplied.
- Solvents (benzene, etc) are not allowable.

NOTE Do not pour fabric softener directly on the clothes

3. Detergent dosage

- The detergent should be used according to the instruction of the detergent manufacture.
- If too much detergent is used more than the recommended amount, too many suds can occur and this will decrease the washing result or cause heavy load to the motor. (Causing a malfunction)
- Use powder detergent only for the front loading washer.
- Detergent usage may need to be adjusted for water temperature, water hardness, size and soil level of the load. For best results, avoid oversudsing.

* Tips

Full load : according to manufacturer's recommendation.
Part load : 3/4 of the normal amount.
Minimum load : 1/2 of full load.

- Detergent is flushed from the dispenser at the beginning of the cycle.

Function

Recommended courses according to the laundry type

Program	Fabric Type	Proper Temp.	Option	Maximum Load	
Cotton	First check if laundry is machine washable. (white cotton, linen towel and sheets...)	95°C	Pre Wash Time Save Rinse+ Crease Care	WD-1016(0~9)SP WD-8016(0~9)SP WD-6516(0~9)SP	WD-1016(0~9)NP WD-8016(0~9)NP WD-6516(0~9)NP
	Color fast gaments (shirts, night dresses, pajamas...)and lightly soiled white cotton(underwear...)	60°C (Cold, 30°C, 40°C)	Pre Wash Time Save Rinse+ Crease Care	Rating	Rating
Synthetic	Polyamide, Acrylic, Polyester	40°C (60°C, Cold, 30°C)	Pre Wash Time Save Rinse+ Crease Care	Less than 1.5 kg	Less than 1.7 kg
Delicate	Delicate laundry easily damaged (silk, curtains...)	30°C (40°C, Cold)	Time Save Rinse+	Less than 1.0 kg	Less than 1.5 kg
Wool	Machine washable woolens with pure new wool only	30°C (40°C, Cold)	Time Save Rinse+	Less than 1.0 kg	Less than 1.5 kg
Hand Wash	"Hand Wash" marked delicate and wool laundry	Cold (30°C, 40°C)	Time Save Rinse+	Less than 1.0 kg	Less than 1.5 kg
Quick 30	Colored Laundry which is lightly soiled fast.	30°C (40°C, Cold)	Rinse+	Less than 1.0 kg	Less than 1.5 kg

* Pre Wash : If the laundry is heavily soiled, "Pre Wash" course is recommended. Pre Wash is available in Cotton and Synthetic Program.

* Eco : By selecting Eco function, the water temperature is reduced and washing time is lengthened. So you can economize in your consumption of heating energy.

* Rinse+ : Used to introduce an additional rinse, which may assist in removing traces of detergent residue.

* Bio : If you want to eliminate protein stains (milk, blood, chocolate...), you may select Bio function by pressing the option button.

NB. You can only select Bio function when temperature is higher than 60°C in Cotton and Synthetic.

How to use washer

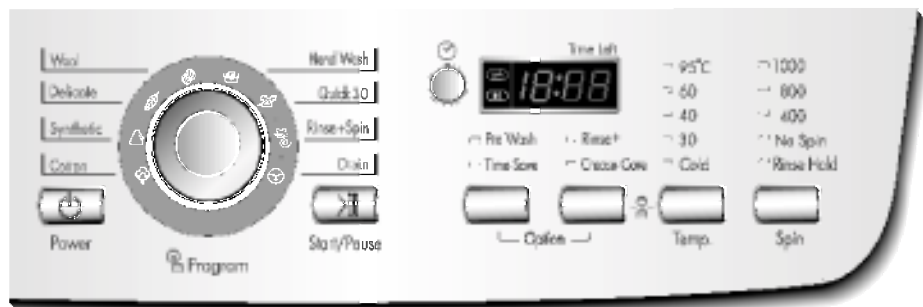

1. Cotton automatically selected upon power on.

- Press the **Power**(⏻) button to start.
- Press the **Start/Pause**(▶||) button.
- Initial condition
 - Wash : main wash
 - Rinse : 3 times
 - Spin : 1000 rpm [WD-1016(0~9)NP / WD-1016(0~9)SP]
800 rpm [WD-8016(0~9)NP / WD-8016(0~9)SP]
650 rpm [WD-6516(0~9)NP / WD-6516(0~9)SP]
 - Water temperature : 60°C
 - Program : Cotton

2. Manual Selecting

- Press the **Power**(⏻) button to start.
 - Select the conditions which you want to use, by pressing each button.
- For selecting the each conditions, please refer to the page15~page20*
- Press the **Start/Pause**(▶||) button.

How to use washer

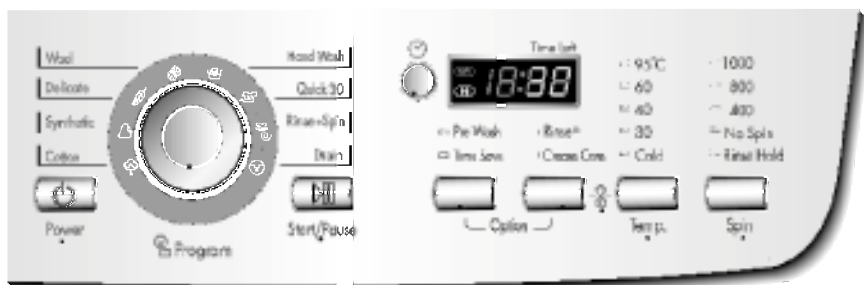

(1) (2) (3) (4) (5) (6) (7) (8) (9)

- | | | |
|--------------------------|-------------------------|--------------------|
| (1) Button : Power | (4) Button : Time Delay | (7) Child Lock |
| (2) Button : Program | (5) Button : Option | (8) Button : Temp. |
| (3) Button : Start/Pause | (6) Button : Option | (9) Button : Spin |

Option

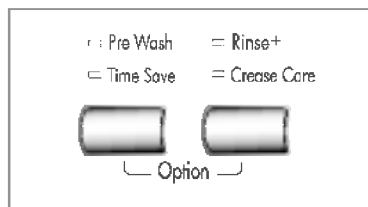

- By pressing the Option button, all Option functions may be selected.

- Pre Wash
- Time Save
- Rinse +
- Crease Care

1. Pre Wash

- If the laundry is heavily soiled, "Pre Wash" course is effective.
- Pre Wash is available in Cotton and Synthetic.

The required lamp will light up for identification.

2. Time Save

- This option can be used to reduce the time of a wash program.
- To use this option press the Time Save button once before the wash program is started.
- This option is not available with Quick 30 program.

3. Rinse+

- Used to additional rinse, which may assist in removing traces of detergent residue.
- By selecting Rinse+ function, the rinse time and the rinse water are increased.

4. Crease Care

- If you want to prevent crease, select this button with spin speed.

How to use washer

Spin

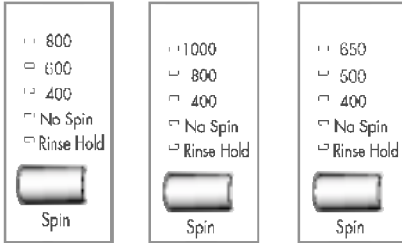

[WD-8016(0-9)NP / WD-8016(0-9)SP] [WD-1016(0-9)NP / WD-1016(0-9)SP] [WD-6516(0-9)NP / WD-6516(0-9)SP]

- By pressing the Spin button, the spin speed can be chosen.

1. Spin selection

- Spin speed is available according to the program as follows.
- **WD-8016(0-9)NP / 8016(0-9)SP**
 - Cotton / Synthetic / Wool / Hand Wash / Delicate / Quick 30
 - Rinse Hold – No Spin – 400 – 600 – 800
- **WD-1016(0-9)NP / 1016(0-9)SP**
 - Cotton / Synthetic / Wool / Hand Wash / Quick 30
 - Rinse Hold – No Spin – 400 – 800 – 1000
 - Delicate
 - Rinse Hold – No Spin – 400 – 800
- **WD-6516(0-9)NP / 6516(0-9)SP**
 - Cotton / Synthetic / Wool / Hand Wash / Delicate / Quick 30
 - Rinse Hold – No Spin – 400 – 500 – 650

2. No spin

- If no spin is selected, the washer stops after draining water.

The required lamp will light up for identification.

3. Rinse Hold

- Is selected by pressing the spin button repeatedly this function leaves clothes in the machine; suspended in the water after a rinse without entering into spin.
- To proceed through to a drain or spin, once the rinse hold function is completed using to Program button and Spin button to the required program.
(Spin or Pump)

The required lamp will light up for identification.

How to use washer

Water Temp.

- 95°C
- 60
- 40
- 30
- Cold



By pressing the Temp. button, the water temperature can be selected.

- Cold
- 30°C/40°C/60°C/95°C

1. Water Temperature

Water temperature can be selected as below according to the program.

- Cotton

Cold – 30°C – 40°C – 60°C – 95°C

- Synthetic

Cold – 30°C – 40°C – 60°C

- Hand Wash & Delicate & Wool & Quick 30

Cold – 30°C – 40°C

The required temperature lamp will light up for identification.

For the more detailed information, please refer to the page 13.

Child Lock

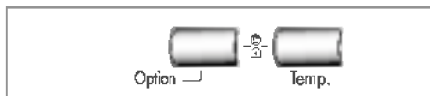

If you choose to lock the buttons on the control assembly to prevent tampering this function may be selected.

1. Child Lock

Child Lock can be set by pressing and holding the the **Option** and the **Temp.** button simultaneously.

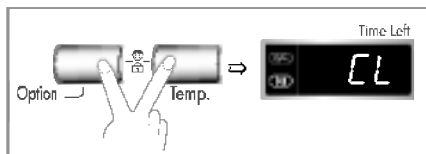

When child lock is set, all buttons are inoperable except power button.

To deactivate Child Lock system, press the **Option** and the **Temp.** button simultaneously again.

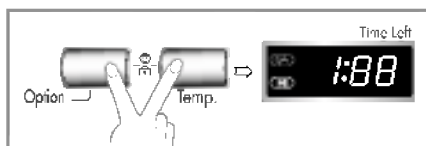

To change to the desired program, whilst in child lock mode.

1. Press both the **Option** and the **Temp.** together once again.
2. Press the **Start/Pause** button.
3. Select the desired program and press the **Start/Pause** button again.

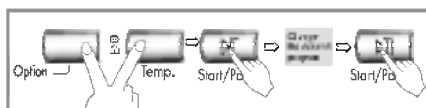

The child lock can be set at any time and it is automatically canceled when operational errors occur. Also **Child Lock** works when power is off.

How to use washer

Time Delay



1. Time Delay

Preparing washing before starting "Time Delay"

- Turn on the water tap.
- Load laundry and close the door.
- Place the detergent and fabric softener in the drawer.

How to set "Time Delay"

- Press **Power** button.
- Press the **Program** button to select the program you require.
- Press **Time Delay** button and set the desired time.
- Press the **Start/Pause** button. (":" blinks.)
- If **Time Delay** button is pressed, "3:00" is displayed. The maximum delayed time is 19:00 hours and the minimum time is 3:00 hours.
- Each pressing of the button advances on time delay by one hour.
- To cancel the time delay, press the **Power** button.
- **Time Delay** is 'expected time' from the present to the completion of washing cycle or selected process (Wash, Rinse, Spin).
- *According to the condition of water supply and temperature, the delayed time and the actual washing time may vary.*

18

Program

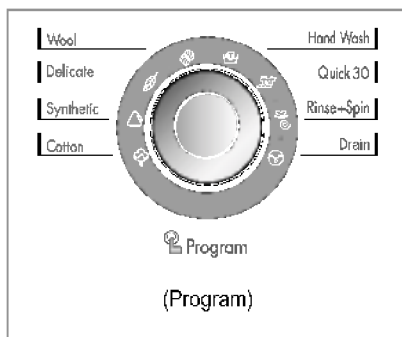

- 8 programs are available according to the laundry type.
- Lamp will light up to indicate selected program.

1. Program

- When **Start/Pause** button is pressed, the Cotton program is automatically selected.
- By pressing the Program button, the program is selected in order of "Cotton – Synthetic – Delicate – Wool – Hand Wash – Quick 30 – Rinse+Spin – Drain".

Regarding to the laundry type for each program Please refer to the page 13.

2. Course

- | | | |
|------------|------------|-------------|
| -Cotton | -Wool | -Rinse+Spin |
| -Synthetic | -Hand Wash | -Drain |
| -Delicate | -Quick 30 | |

How to use washer

Start/Pause



Start/Pause

1. Start

- This **Start/Pause(▶||)** button is used to start wash cycle or pause the wash cycle.

2. Pause

- If temporary stop of wash cycle is needed, press the **Start/Pause(▶||)** button.
- When in Pause, the power is turned off automatically after 4 minutes.
- **NB.** The door will not open before 1 to 2 minutes when Pause is selected, or at the end of the wash cycle.

Power



Power

1. Power

- Press the Power button to turn power on and off

2. Initial Program

- When the Power button is pressed, the washer is ready for Cotton program. And the other initial conditions as follows.
- So, if you want to advance into the washing cycle without changing the program, just press the **Start/Pause(▶||)** button and then the washer will proceed.

Initial program

[WD-8016(0~9)NP / 8016(0~9)SP]

*-Cotton Program/Main Wash/
Normal Rinse/800 rpm/60°C*

[WD-1016(0~9)NP / 1016(0~9)SP]

*-Cotton Program/Main Wash/
Normal Rinse/1000 rpm/60°C*

[WD-6516(0~9)NP / 6516(0~9)SP]

*-Cotton Program/Main Wash/
Normal Rinse/650 rpm/60°C*

How to use washer

Display



1. Special function display

- When child lock is selected, the "LL" is displayed.
- If the machine encounters a fault during operation; the associated fault will be displayed

2. Self diagnosis display

- If the machine encounters a fault during operation, the associated fault will be displayed.
 - "PE" : Water pressure sensing error
 - "FE" : Problem of overfilling water
 - "dE" : Door is not closed
 - "lE" : Water inlet trouble
 - "DE" : Drainage trouble
 - "UE" : Unbalanced load
 - "tE" : Water temperature trouble

If these error letters are displayed, please refer to the troubleshooting page24 and follow the guide.

3. Completion of washing

- When washing cycle is completed, "End" is displayed on the "Multi display".

4. Time left

- During washing cycle, the remaining washing time is displayed.
- Recommended program by manufacturer.

※ () : WD-1016(0~9)SP/WD-8016(0~9)SP

- Cotton 95°C : around 2 hours and 27(17) minutes
- Cotton 60°C : around 2 hours and 35 minutes
- Synthetic : around 1 hour and 22 minutes
- Delicate : around 56 minutes
- Wool : around 58 minutes
- Hand Wash : around 57 minutes
- Quick 30 : around 30 minutes
- Rinse+ Spin : around 20 minutes
- Drain : around 1 minute

- The washing time may vary by the amount of laundry, water pressure, water temperature and other washing conditions.
- If an unbalanced load is detected or if the suds removing program operates, the wash time may be extended.
(Max. increasing time is 45minutes.)

Maintenance

- * Before cleaning the washer interior, unplug the electrical power cord to avoid electrical shock to avoid electrical shock hazards.
- * When disposing of the appliance, cut off the mains cable, and destroy the plug Disable the door lock to prevent young children being trapped inside.

■ The water inlet filter

- "IE" error message will blink on the control panel when water does not enter the detergent drawer.
- If your water is very hard or contains traces of lime deposit, the water inlet filter may become clogged.

It is therefore a good idea to clean it from time to time.

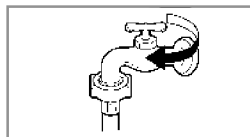

1. Turn off the water tap.



2. Unscrew the water inlet hose.

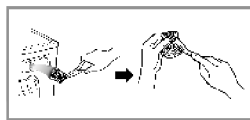

3. Clean the filter using a hard bristle brush.



4. Tighten up the inlet hose.

■ The drain pump filter

- * The drain filter collects threads and small objects left in the laundry.
- Check regularly that the filter is clean to ensure smooth running of your machine.

▲ CAUTION First drain using the drain and then open the pump filter to remove whatever any threads or objects.

Be careful when draining if the water is hot.

- * Allow the water to cool down before cleaning the drain pump, carrying out emergency emptying or opening the door in an emergency.

1. Open the lower cover cap (①) by using a coin. Turn the drain plug (②) to pull out the hose.
2. Unplug the drain plug (②), allowing the water to flow out. At this time use a vessel to prevent water flowing on to the floor. When water does not flow any more, turn the pump filter (③) open to the left.
3. Remove any foreign material from the pump filter (③). After cleaning, turn the pump filter (③) clockwise and insert the drain plug (②) to the original place. Close the lower cover cap.

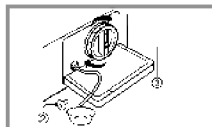
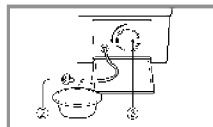
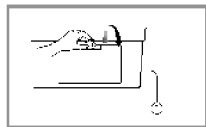

Maintenance

■ Dispenser drawer

- * After a while detergents and fabric softeners leave a deposit in the drawer.
- It should be cleaned from time to time with a jet of running water.
- If necessary it can be removed completely from the machine by pressing the catch downwards and by pulling it out.
- To facilitate cleaning, the upper part of the fabric softener compartment can be removed.

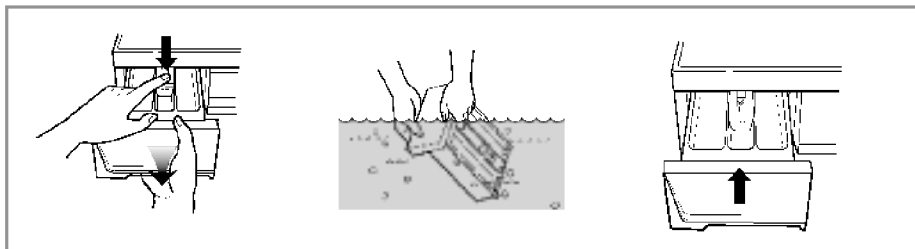

■ The drawer recess

- * Detergent can also accumulate inside the recess which should be cleaned occasionally with an old toothbrush.
- Once you have finished cleaning, replace the drawer and run a rinse cycle without laundry.

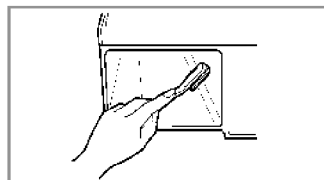

■ The washing drum

- If you live in a hard water area, limescale may continuously build up in places where it cannot be seen and thus not easily removed. Over time the build up of scale clogs appliances, and if it is not kept in check these may have to be replaced.
- Although the washing drum is made of Stainless steel, specks of rust can be caused by small metal articles (paper clips, safety pins) which have been left in the drum.
- The washing drum should be cleaned from time to time.
- If you use descaling agents, dyes or bleaches, make sure they are suitable for washing machine use.
- * Descaler may contain chemicals that may damage part of your washing machine.
- * Remove any spots with a stainless steel cleaning agent.
- * Never use steel wool.

Maintenance

■ Cleaning your washer

1. Exterior

Proper care of your washer can extend its life.

The outside of the machine can be cleaned with warm water and a neutral non abrasive household detergent.

Immediately wipe off any spills. Wipe with damp cloth.

Try not to hit surface with sharp objects.

* IMPORTANT: Do not use methylated spirits, diluents or similar products.

2. Interior

Dry around the washer door opening, flexible gasket and door glass.

Run washer through a complete cycle using hot water.

Repeat process if necessary.

NOTE Remove hard water deposits using only cleaners labeled as washer safe.

■ Cold condition

If the washer is stored in an area where freezing may occur or moved in freezing temperatures, follow these instructions to prevent damage to the washer:

1. Turn off water supply tap.
2. Disconnect hoses from water supply and drain water from hoses.
3. Plug electrical cord into a properly grounded electrical outlet.
4. Add 1gallon(3.8L) of nontoxic recreational vehicle(RV) antifreeze into an empty wash drum.
Close the door.
5. Set spin cycle and let washer spin for 1minute to drain out all water.
Not all of the RV antifreeze will be expelled.
6. Unplug electrical power cord, dry the drum interior, and close the door.
7. Remove dispenser drawer drain and dry excessive water from the compartments.
8. Store washer in an upright position.
9. To remove antifreeze from washer after storage, run empty washer through a complete cycle using detergent. Do not add wash load.

Troubleshooting guide









* This washing machine is equipped with automatic safety functions which detect and diagnose faults at an early stage and react appropriately
When the machine does not function properly or does not function at all, check the following points before you contact your service provider.





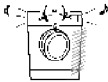

Symptom	Possible Cause	Solution
Rattling and clanking noise	<ul style="list-style-type: none"> Foreign objects such as coins or safety pins may be in drum or pump. 	<p>Stop washer and check drum and drain filter.</p> <p>If noise continues after washer is restarted, call your authorised service centre.</p>
Thumping sound	<ul style="list-style-type: none"> Heavy wash loads may produce a thumping sound. This is usually normal. 	<p>If sound continues, washer is probably out of balance. Stop and redistribute wash load.</p>
Vibrating noise	<ul style="list-style-type: none"> Have all the transit bolts and packing been removed? Are all the feet resting firmly on the ground? 	<p>If not removed during installation. Refer to Installation guide for removing transit bolts.</p> <p>Wash load may be unevenly distributed in drum. Stop washer and rearrange wash load.</p>
Water leaks.	<ul style="list-style-type: none"> Fill hoses or drain hose are loose at tap or washer. House drain pipes are clogged. 	<p>Check and tighten hose connections.</p> <p>Unclog drain pipe. Contact plumber if necessary.</p>
Oversudsing		<p>Too much detergent or unsuitable detergent may cause excessive foaming which may result in water leaks.</p>
Water does not enter washer or it enters slowly	<ul style="list-style-type: none"> Water supply is not adequate in area. Water supply tap is not completely open. Water inlet hose(s) are kinked. The filter of the inlet hose(s) clogged. 	<p>Check another tap in the house.</p> <p>Fully open tap.</p> <p>Straighten hose.</p> <p>Check the filter of the inlet hose.</p>
Water in the washer does not drain or drains slowly.	<ul style="list-style-type: none"> Drain hose is kinked or clogged. The drain filter is clogged. 	<p>Clean and straighten the drain hose.</p> <p>Clean the drain filter</p>

Troubleshooting guide

Symptom	Possible Cause	Solution
Washer does not start	<ul style="list-style-type: none"> • Electrical power cord may not be plugged in or connection may be loose. • House fuse blown, circuit breaker tripped, or a power outage has occurred. • Water supply tap is not turned on. 	<p>Make sure plug fits tightly in wall outlet.</p> <p>Reset circuit breaker or replace fuse. Do not increase fuse capacity. If problem is a circuit overload, have it corrected by a qualified electrician. Turn on water supply tap.</p>
Washer will not spin	<ul style="list-style-type: none"> * Check that the door is firmly shut. 	<p>Close the door and press the Start/Pause button. After pressing the Start/Pause button, it may take a few moments before the clothes washer begins to spin. The door must lock before spin can be achieved.</p>
Door does not open		<p>Once started, the door can not be opened for safety reasons. Wait one or two minutes before opening the door to give the electric locking mechanism time to release.</p>
Wash cycle time delayed		<p>The washing time may vary by the amount of laundry, water pressure, water temperature and other usage conditions.</p> <p>If the imbalance is detected or if the suds removing program works, the wash time shall be increased.</p>

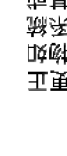
Troubleshooting guide

Symptom	Possible Cause	Solution
	<ul style="list-style-type: none"> Water supply is not adequate in area Water supply taps are not completely open. Water inlet hose(s) are kinked. The filter of the inlet hose(s) clogged. 	<p>Check another tap in the house. Fully open tap.</p> <p>Straighten hose(s). Check the filter of the inlet hose.</p>
	<ul style="list-style-type: none"> Drain hose is kinked or clogged. The drain filter is clogged. 	<p>Clean and straighten the drain hose.</p> <p>Clean the drain filter.</p>
	<ul style="list-style-type: none"> Load is too small. Load is out of balance. The appliance has an unbalance detection and correction system. If individual heavy articles are loaded (ex. bath mat, bath robe, etc.), this system may stop spinning or even interrupt the spin cycle altogether. If the laundry is still too wet at the end of the cycle, add smaller articles of laundry to balance the load and repeat the spin cycle. 	<p>Add 1 or 2 similar items to help balance the load.</p> <p>Rearrange load to allow proper spinning</p>
	 <ul style="list-style-type: none"> Is the door opened? 	<p>Close the door.</p> <p>* If "dE" is not released, call for service.</p>
		<p>Unplug the power plug and call for service.</p>
	<ul style="list-style-type: none"> Water overfills due to the faulty water valve. 	<p>Close the water tap.</p> <p>Unplug the power plug.</p> <p>Call for service.</p>
	<ul style="list-style-type: none"> Water level sensor has malfunction. 	

解決方法	可能成因	問題
檢查屋內另一次喉。 完全開啟水喉。 將水管變直。 檢查入水管過濾器。	<ul style="list-style-type: none"> • 供水不足。 • 水喉並不完全開啟。 • 入水管打結。 • 入水管過濾器淤塞。 	
清理並將排水管變直。 清理排水過濾器。	<ul style="list-style-type: none"> • 排水管打結或淤塞。 • 排水過濾器淤塞。 	
加入一至兩件衣物幫助平衡。 重新擺放衣物。 如衣物在完成洗衣程序後仍然很濕，可加入小型衣物作平衡，重新旋轉程式。	<ul style="list-style-type: none"> • 太少衣物。 • 衣物擺放不均。 • 此機有衣物平衡感應及更正系統，機內如有大件衣物如浴室地氈、浴衣等，此系統或會令洗衣機停止轉動甚或擾亂轉動系統。 • 如衣物在完成洗衣程序後仍很濕，可加入小型衣物作平衡，重新旋轉程式。 	
關上機門。 * 如機身仍有顯示"PE"字樣，可聯絡技術員。	• 機門是否已關？ 	
拔掉插頭並聯絡技術員。		
關上水喉。 拔掉插頭。聯絡技術員。	<ul style="list-style-type: none"> • 如因損壞的活瓣引起注水過多，洗衣機會顯示"FE"字樣。 	
	<ul style="list-style-type: none"> • 水位感應器出現故障，洗衣機會出現"PE"字樣。 	

解決問題指引

解決方法	可能成因	問題
<p>確保插頭穩插插座。</p> <p>更換保險絲。切勿增加保險絲容量。</p> <p>如因電力負荷過重，聯絡合格技師更正。</p> <p>扭開水喉。</p> <p>關上機門並按開始/暫停鍵。按開始/暫停鍵後，洗衣機或需待數分鐘才能旋轉。洗衣機旋轉前必須將機門鎖上。</p>	<ul style="list-style-type: none"> • 沒有接駁插頭或接駁位已鬆。 • 屋內保險絲燒毀，電流不能通過，或停電。 • 水喉沒有扭開。 * 檢查機門是否鎖死。 	<p>洗衣機不能啟動</p> <p>洗衣機不旋轉</p> <p>不能開啟機門</p>
<p>由於安全理由，開始洗衣程序後，機門不能開啟，請等候一至兩分鐘才開啟機門。</p>		<p>洗衣程序時間順延</p>
<p>洗衣時間會隨著衣物數量，水壓，水溫及其他條件影響。如洗衣機感應到衣物擺放不均或泡沫過多，洗衣時間亦會更長。</p>		

解決問題指引

解決方法	可能成因	問題
<p>停止洗衣並檢查排水插及排水過濾器。如聲音持續，聯絡技術員。</p> <p>如聲音持續，衣物擺放可能不均，應停止洗衣並重新擺放衣物。</p> <p>如外裝時沒有移去雜物，參考外裝部份將雜物拿掉。</p> <p>衣物擺放不均。停止洗衣並重新擺放衣物。</p>	<ul style="list-style-type: none"> • 洗衣箱內可能有硬幣或扣針等異物。 • 正常情況下，過多衣物會引起重擊聲。 • 是否已將所有運輸雜物及包裝紙移除？ • 所有機腳是否穩放地面？ 	<p>尖利及叮噠聲</p> <p>重擊聲</p> <p>震動聲</p>
<p>使用過多或不合適的清潔劑？</p> <p>過多泡沫會引起漏水。</p> <p>檢查室內另一次喚。</p> <p>完全開啟水喉。</p> <p>使水管變直。</p> <p>檢查入水管過濾器。</p> <p>清理並裝排水管變直。</p> <p>清理排水過濾器。</p>	<ul style="list-style-type: none"> • 入水管或排水嘴接駁位鬆脫。 • 排水管淤塞。 • 供水不足。 • 水喉未完全開啟 • 入水管打結。 • 入水管過濾器淤塞。 • 排水管打結或淤塞。 • 排水過濾器淤塞。 	<p>漏水</p> <p>泡沫過多</p> <p>不能注水或注水速度慢</p> <p>不能排水或排水速度慢</p>

* 此機型會由豐坊的技師，可以獲羅技師原因，及早停止煩。如洗衣機不能正常運轉，請聯絡技師中心查詢詳情下列各項。

繁瑣問題指引

維修保養

■ 清潔洗衣機

1. 外部

- 小心保養閣下的洗衣機會令它更耐用。
- 洗衣機外殼可用暖水及中性不粗糙的家用清潔劑清潔。
- 利用微濕的布立即抹掉任何溢出的清潔劑。
- 小心勿讓鋒利物體撞擊洗衣機表面。
- * 重要：切勿使用燃料酒精、稀釋液或類似產品。

2. 內部

- 經常清潔機門開口、彈性密封墊及機門玻璃，確保洗衣時不會漏水。
- 利用熱水進行一次洗衣程序。
- 如有需要重覆以上程序一次。
- 注意：**清理硬水殘積物時請利用適用於洗衣機的清潔劑。

- * 切勿利用鋼絲清潔。
- * 利用不銹鋼清潔劑清理污漬。
- * 除污劑或含破壞洗衣機的成分。
- * 請使用適用於洗衣機的除污劑、染料或漂白劑。
- * 滾桶應經常清洗。
- * 雖然滾桶以不銹鋼製成，若滾桶內留有小型金屬物件(圖字及，扣針)，仍會引起銹漬。
- * 積聚過多石灰片會阻塞洗衣機，如長期缺乏檢查會令滾桶需要更換。
- * 如閣下住在硬水區，石灰片會在隱蔽的地方積聚並難於清理。

■ 洗衣滾桶

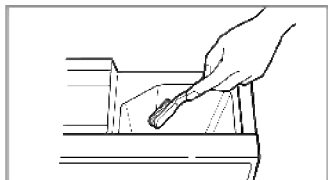

- * 清潔完畢後，放回盛格並進行一次沖水程序。
- * 清潔劑亦會積聚在盛格底部，請定期利用齒牙刷清潔。

■ 清潔盛格預

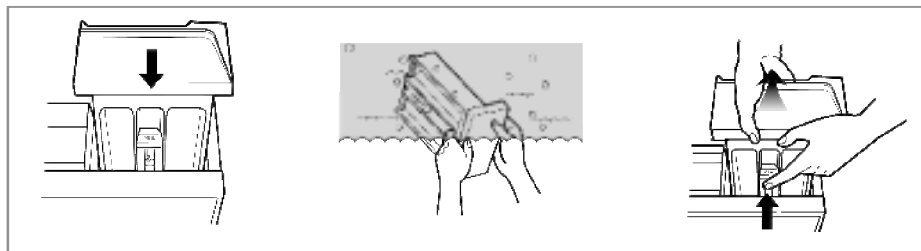

- * 清潔劑及衣物柔順劑會累積在盛格內。
- * 定期利用噴射式開水清潔。
- * 如有需要，可將盛格按下拉出。
- * 為方便清潔，衣物柔順劑格頂部可移除。

■ 清潔盛格

維修保養

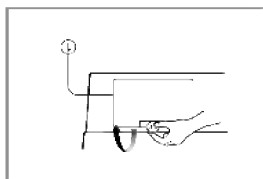

1. 利用硬幣將機底封蓋帽子 ② 將水管拉出。

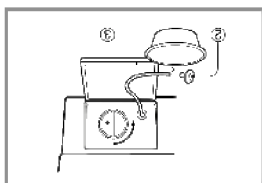

2. 拿走排水栓子 ② 讓水流出水。這時利用器皿承接流出，防止水流在地面。待所有水排出後，向右扭開水泵過濾器 ③。

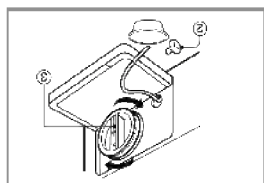

3. 拿出水泵過濾器 ③ 內的異物，清理後順時針方向扭動水泵過濾器 ③ 放回原處。關上機底封蓋。

▲ 警告

首先利用排水管排水，然後打開水泵過濾器清除阻礙物。排水時小心水溫過熱。

■ 排水泵過濾器

* 排水過濾器收集衣物的毛頭及小型物件。經常檢查過濾器清潔，確保洗衣機操作順利。

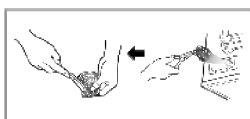

3. 利用硬短毛刷清潔過濾器。

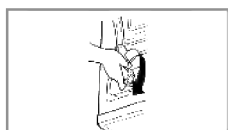

4. 將入水管扭緊。

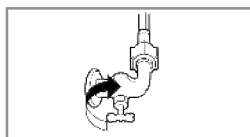

1. 關掉水喉。



2. 鬆開入水管。

■ 入水過濾器

- 如不能進入清潔劑盛格，控制面板上會閃動著“E”字樣。

- 如注入的水為硬水或含有少量石灰，入水過濾器或會淤塞，建議閣下經常清潔入水過濾器。

* 清潔洗衣機內部時，請先將電源截斷，防止觸電危險。

維修保養

如何使用洗衣機

顯示



1. 特別功能顯示

- 設定兒童鎖後，洗衣機會顯示“**CL**”字樣。
- 選擇延遲洗衣功能後，洗衣機會顯示直至完成所需程式的剩餘時間。

2. 自我診斷顯示

- 洗衣機如出現故障，會顯示故障類型。
 - “**PE**”：水壓問題
 - “**FE**”：注水過多
 - “**PF**”：機門未關
 - “**IE**”：注水問題
 - “**OE**”：排水問題
 - “**UE**”：機身不平衡
 - “**EE**”：水溫問題
- 如洗衣機顯示以上故障字樣，請參考第26頁的解決方法。

3. 洗衣程序完結

- 洗衣程序完結時，洗衣機的顯示板會顯示“**End**”字樣。

4. 剩餘時間

- 洗衣時，洗衣機會顯示剩餘所需時間。
- 生產商建議程式

※ () : WD-1016(0-9)SP / WD-8016(0-9)SP

- 棉質衣物 95°C : 約2小時27(17)分鐘
- 棉質衣物 60°C : 約2小時35分鐘
- 人造纖維 : 約1小時22分鐘
- 柔軟衣物 : 56分鐘
- 羊毛衣物 : 58分鐘
- 手洗衣物 : 57分鐘
- 30分鐘快洗 : 30分鐘
- 沖水+旋轉 : 20分鐘
- 泵水 : 1分鐘

- 洗衣時間會隨著衣物量、水壓、水溫及其他洗衣條件改變。

- 如衣物擺放不平均或去泡程式運作中，洗衣時間或會較長。
- (最多增加45分鐘。)

如何使用洗衣機

開始/暫停



1. 開始

- 按**開始/暫停**鍵開始洗衣程序。

2. 暫停

- 按**開始/暫停**“**暫停**”洗衣程序。
- 按下**暫停**鍵後，洗衣機會在4分鐘後自動關掉。
- 注意：選擇**暫停**後及在洗衣程序完結前1至此分鐘，機門並不能門啓。

1. 電源

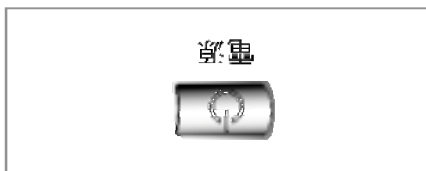

電源

- 按**電源** (⏻) 鍵關閉洗衣機。
- 此鍵亦可作取消**延遲**洗衣用。

2. 原有程式

- 按下**電源** (⏻) 鍵後，洗衣機會進行棉質衣物清洗程式。其他設定條件如下。
 - 所以，如不用選擇其他洗衣程式，可按**開始/暫停**鍵進行洗衣程序。
- 原有程式

[WD-8016(0-9)NP / 8016(0-9)SP]

- 棉質衣物程式 / 清洗 / 正常沖水 / 800 rpm / 60°C

[WD-1016(0-9)NP / 1016(0-9)SP]

- 棉質衣物程式 / 清洗 / 正常沖水 / 1000 rpm / 60°C

[WD-6516(0-9)NP / 6516(0-9)SP]

- 棉質衣物程式 / 清洗 / 正常沖水 / 650 rpm / 60°C

如何使用洗衣機

延遲洗衣

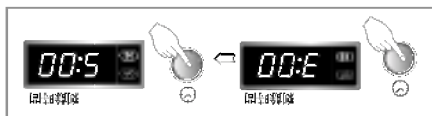

開始“延遲洗衣”前請先預備好衣物。

- 開啟水喉。

- 放入衣物，關上機門。

- 放入清潔劑及衣物柔順劑在盛格內。

• 如何設定“延遲洗衣”時間

- 按電源 (⏻) 鍵。

- 轉動程式旋鈕選擇所需程式。

- 按延遲洗衣鍵設定所需時間。

- 按開始/暫停鍵 (“▶”閃動)

• 如延遲洗衣鍵按下，洗衣機會顯示

“3:00”。最長順延時間為1小時，最短

順延時間為3小時。

• 每次按鍵會將時間順延一小時。

• 按電源 (⏻) 鍵取消延遲洗衣功能。

• 延遲洗衣時間為即時至洗衣程式或選擇

過程(清洗，沖水，旋乾)完結時的“預期

時間”。

• 所順延的時間及實際所需洗衣時間會受不
同供水情況及水溫影響。

1. 延遲洗衣

1. 程式

- 此機共有8種不同程式，讓閣下根據不同衣物種類選用。
- 指示燈會亮起以顯示所選程式。

• 按下開始/暫停鍵後，洗衣機會自動選擇棉質衣物-經濟程式。

- 轉動程式旋鈕，程式會按以下次序讓閣下

選擇：棉質衣物-人造纖維-

柔軟衣物-羊毛衣物-手洗衣物-

30分鐘快洗-沖水+旋轉-泵水

想知道適合於各種程式的衣物種類，可參考第13

2. 過程

- 棉質衣物 - 羊毛衣物 - 沖水+旋轉
- 人造纖維 - 手洗衣物 - 泵水
- 柔軟衣物 - 30分鐘快洗

程式

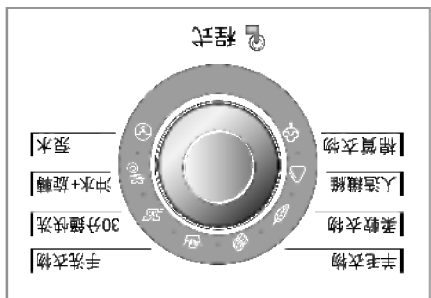

兒童鎖可隨時設定，並會在操作出現故障時取消。兒童鎖在關掉電源後亦能運作。

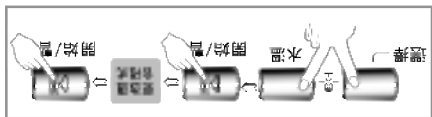

3. 更改所需程式，再按開始/暫停鍵。
 2. 按開始/暫停鍵。
 1. 同時按選擇鍵及水溫鍵。
- 如需在兒童鎖生效時更改洗衣程式，

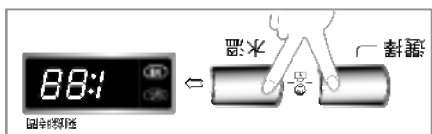

- 兒童鎖設定後，所有按鍵均不能操作。
- 如需取消兒童鎖系統，再次同時按選擇鍵及水溫鍵便可。



- 同時按選擇鍵及水溫鍵便可設定兒童鎖。

1. 兒童鎖

選擇此功能，可防止兒童或老人操作洗衣機。

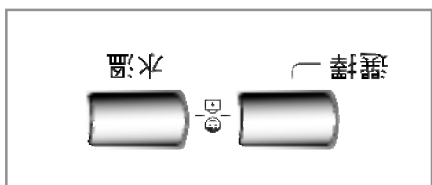

兒童鎖

燈號亮着表示該溫度已被選擇。
如需更多詳情，可參考第13頁。

- 棉質衣物
冷水 - 30°C - 40°C、60°C - 95°C
- 人造纖維
冷水 - 30°C - 40°C、60°C
- 柔軟衣物/羊毛衣物/30分鐘快洗
冷水 - 30°C - 40°C

• 按以下程式選擇所需水溫

1. 水溫



• 按水溫鍵可選擇所需水溫。

水溫

如何使用洗衣機

如何使用洗衣機

旋轉

旋轉	旋轉	旋轉
<ul style="list-style-type: none"> ● 暫停沖水 ● 不脫水 ● 400 ● 500 ● 650 	<ul style="list-style-type: none"> ● 暫停沖水 ● 不脫水 ● 400 ● 800 ● 1000 	<ul style="list-style-type: none"> ● 暫停沖水 ● 不脫水 ● 400 ● 500 ● 800

[WD-8016(0-9)NP/WD-1016(0-9)NP/WD-6516(0-9)SP] [WD-1016(0-9)NP/WD-6516(0-9)SP] [WD-8016(0-9)SP]

- 按旋轉鍵可選擇旋轉速度

1. 旋轉選擇

- 按以下程式選擇所需速度。
 - **WD-8016(0-9)NP / 8016(0-9)SP**
棉質衣物/人造纖維/羊毛衣物/
柔軟衣物/手洗衣物/
30分鐘快洗
 - **WD-1016(0-9)NP / 1016(0-9)SP**
棉質衣物/人造纖維/
羊毛衣物/手洗衣物/30分鐘快洗
暫停沖水-不脫水-400-800-1000
 - **WD-6516(0-9)NP / 6516(0-9)SP**
棉質衣物/人造纖維/羊毛衣物/
柔軟衣物/
30分鐘快洗
暫停沖水-不脫水-400-500-650
- 燈號亮着表示該功能已被選。
- 如沖水後將衣物留在機內而不旋轉，可按旋轉鍵暫停沖水，防止衣物變皺。
 - 選擇暫停沖水功能後，如需排水及旋乾，可按開始/暫停鍵取消暫停沖水功能，並選擇所需旋速或程式。再按開始/暫停鍵開始程式。
 - 如只需排水，請選擇不脫水或泵水程式。

3. 暫停沖水

- 燈號亮着表示該功能已被選。
- 如沒有選擇旋速，洗衣機會在排水後不脫水。

2. 不脫水

如何使用洗衣機

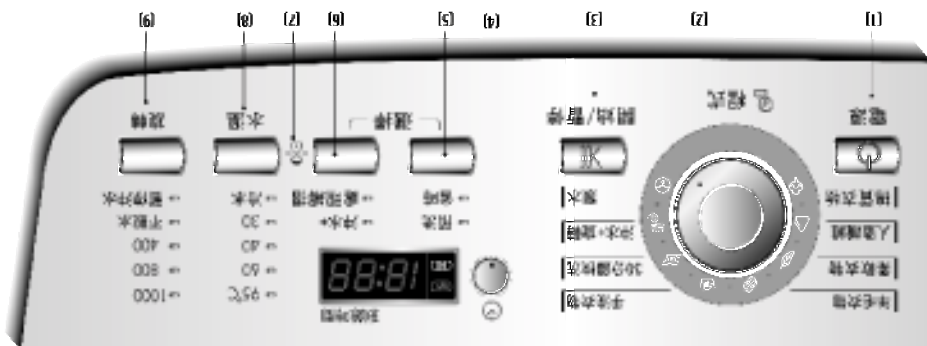

- (1) 按鈕：電源
(2) 旋鈕：程式
(3) 按鈕：開始/暫停
(4) 按鈕：延遲洗衣
(5) 按鈕：選擇
(6) 按鈕：選擇
(7) 兒童鎖
(8) 按鈕：水溫
(9) 按鈕：旋轉

選擇

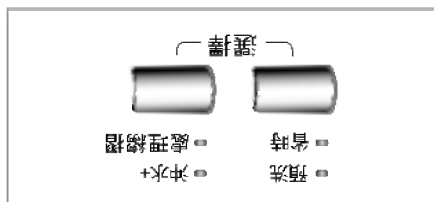

- 按沖水鍵選擇所需沖水模式。

- 預洗
- 省時
- 沖水+
- 處理縐摺

1. 預洗

- 如衣物嚴重污染，“預洗”程序能產生更佳洗衣效果。
- 預洗程序適用於棉質衣物及人造纖維。

燈亮表示該功能已被選。

4. 處理縐摺

- 若要防止衣物出現縐摺，請選擇此功能運脫水程式。

3. 沖水+

- 如需額外沖水，沖水+功能可將殘餘清潔劑去除。
- 選擇沖水+功能後，沖水時間及沖水量會增加。

2. 省時

- 此功能可減時洗衣時間。
- 如需節省洗衣時間，開始洗衣程式前按此鍵便可。
- 此功能不適用於30分鐘快洗程式。

- 程式：棉質衣物
- 水溫：60°C

- 旋轉：每分鐘 1000 轉 [WD-1016(0-9)NP/
WD-1016(0-9)SP]
800 轉 [WD-8016(0-9)NP/
WD-8016(0-9)SP]
650 轉 [WD-6516(0-9)NP/
WD-6516(0-9)SP]

- 沖水：3次

- 清洗：只行清洗

• 開始時狀態

• 按開始/暫停鍵。

• 按電源 (⏻) 鍵開始。

• 按開始/暫停鍵。

• 按鍵選擇所需狀態。選擇不同狀態可參考15至20頁。

• 按電源 (⏻) 鍵開始。

1. 原有設定程式(棉質衣物)

2. 自選程式



如何使用洗衣機

- * 預洗：如衣物嚴重污染，“預洗”程序能產生更佳洗衣效果。預洗程序適用於棉質衣物及人造纖維洗衣程式。
- * 經濟：選擇經濟功能，水溫會降低，洗衣時間會較長，減少耗電量。
- * 沖水+：可額外沖洗衣物多一次，有助清除衣物中殘餘的洗衣劑。
- * 彩漂：如需清除蛋白污漬(牛奶，血，朱古力…)，可選擇彩漂功能。
- * NB. 清洗棉質衣物及人造纖維時，如水溫高於60°C，可選擇彩漂功能及經濟功能。

程式	衣物種類	適合水溫	選擇	最大洗衣量
棉質衣物	先檢查衣物是否適合機洗。 (白色棉質、亞麻 毛巾及被單…)	95°C	預洗 省時 沖水+	WD-1016(0-9)NP WD-8016(0-9)SP WD-8016(0-9)NP WD-6516(0-9)SP WD-6516(0-9)NP
	不褪色衣物(恤 衫、晚裝、睡衣 …)及微污白色 棉質衣物(內衣 …)		預洗 省時 沖水+ 處理總選	定量
人造纖維	人造纖維(尼龍、 丙綸醜纖維、 聚酯纖維)	40°C (60°C, 冷水, 30°C)	預洗 省時 沖水+ 處理總選	少於 1.5公斤
柔軟衣物	柔軟易受損衣物 (絲、窗簾…)	30°C (40°C, 冷水)	省時 沖水+	少於 1.5公斤
羊毛衣物	可機洗細 羊毛衣物	30°C (40°C, 冷水)	省時 沖水+	少於 1.5公斤
手洗衣物	印有“手洗”標 籤的柔軟及羊 毛衣物	冷水 (30°C, 40°C)	省時 沖水+	少於 1.5公斤
30分鐘 快洗	與棉質衣物及人造纖 維一樣	30°C (40°C, 冷水)	沖水+	少於 1.5公斤

■根據衣物種類建議清洗方法

* 能源標籤數據根據棉質衣物在60°C水溫清洗，利用EN60456測試得出的結果。

加入清潔劑

■ 加入清潔劑及衣物柔順劑

1. 清潔劑盛格

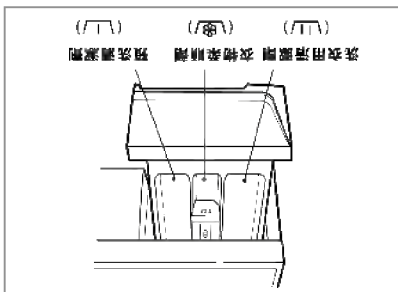

• 只供清洗用 (1)

• 預洗+清洗 (1) • (1)

2. 加入衣物柔順劑



• 切勿超過可注入限量，過多衣物柔順劑會令衣物染上污漬。

• 切勿將衣物柔順劑放在盛格超過兩天。

(柔順劑會變硬)

• 柔順劑會在最後過水程式時自動加入。

• 注水時切勿打開清潔劑盛格。

• 切勿加入膏劑如茶。

注意 切勿將柔順劑直接倒在衣物上。

3. 清潔劑份量

- 應根據清潔劑生產商指示使用適量清潔劑。
- 使用過量清潔劑，會產生過多泡沫，影響清潔效果或加重發動機負擔。(引起故障)
- 使用適合前置式洗衣機之洗衣粉。
- 清潔劑使用會因水溫、水種類、衣物大小及污染程度而改變，為保持最佳效果，防止過多泡沫產生。

* 忠告

- 稠密衣物量：按駝峰標圖標。
- 部分衣物量：正常衣物量的3/4。
- 最少衣物量：稠密衣物量的一半。

• 清潔劑在洗衣程式開始時注入。

洗衣前護理

■ 洗衣前護理

1. 護理標籤

查看閣下衣物的護理標籤，上面印有衣物纖維類別及清洗方法。

2. 分類

為達到最佳效果，請在每次清洗過程中清洗同類型衣物。不同衣物清洗方法各有不同，包括水溫及旋轉速度。切勿將深淺衣物分開清洗，防止白色衣物染色。在可能情況下，切勿同時清洗嚴重染污及輕微染污衣物。

污漬嚴重，一般：輕微)

顏色(白色，淺色，深色)

毛頭製造毛頭衣物，易黏毛頭衣物)

將製造毛頭衣物及易黏毛頭衣物分開清洗。

根據污漬嚴重程度分類。

將白色及顏色衣物分開。

3. 放入衣物前護理

■ 將大小衣物混合清洗，先放大件衣物，再放大件衣物，但大件衣物不能超過重洗衣量的半。切勿清洗一件衣物，這會引起衣物不平整，可加入一至兩件類似衣物。

• 檢查所有袋口，確保沒有雜物，鐵釘、髮夾、火柴、原子筆、硬幣及鑰匙等物件均會對洗衣機及衣物造成損害。

• 將拉鍊、扣子及繩繫好，防止衣物被刮破。

• 利用稀釋的清潔劑預先處理袖口及衣領，減低污漬程度。

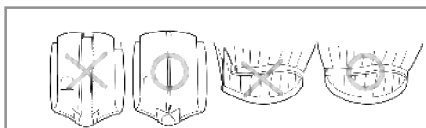
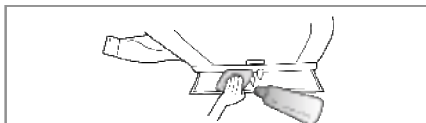

安裝

■ 機身平衡

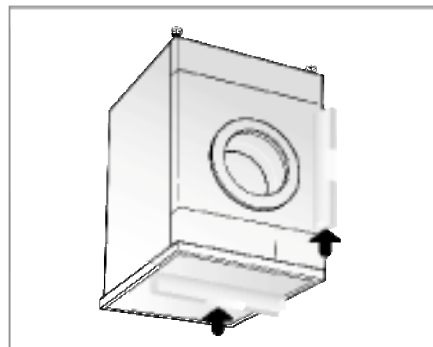

1. 調校機身防止過多噪音及震動。
將洗衣機安裝在平地上，最好放在房間
的角落。

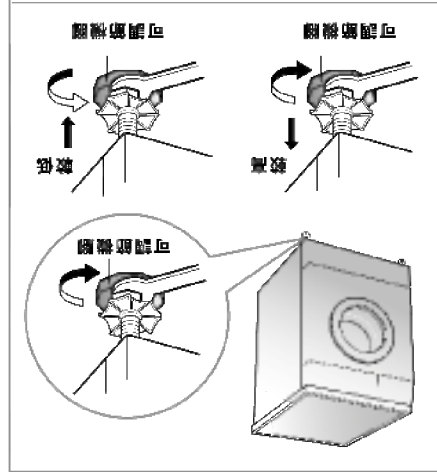

2. 如地面不平，調校可調節機腳。(切勿利
用木塊等物件墊高)確保四隻機腳平穩安
放在地上，檢查機身是否平衡。(利用心
理水平尺)

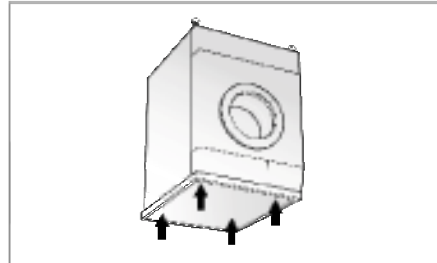

- * 對角檢查
將洗衣機頂板對角壓下，洗衣機應不會上下搖
擺。(請檢查兩個對角)如機身出現搖晃，請再
次調校機腳。

- 切勿將排水管放在離地100厘米的高度。
- 將排水管繫緊能避免漏水破壞地板。
- 將排水管繫緊至洗手盤時，用繩將它繫緊。
- 將排水管繫緊能避免漏水破壞地板。

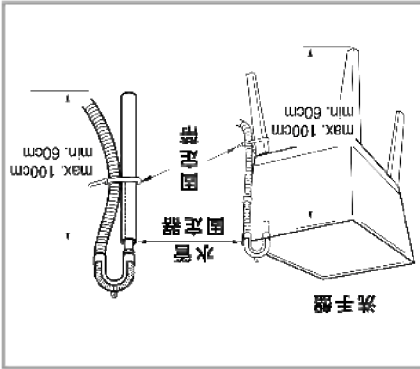

- 安裝排水管至洗手盤時，用繩將它繫緊。
- 繫緊排水管可防止漏水破壞地板。

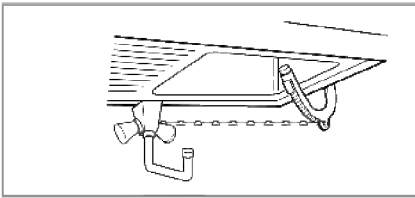

- 切勿將排水管放在離地100厘米的高度。
- 將排水管繫緊能避免漏水破壞地板。
- 如排水管過長，切勿將它塞進洗衣機，這會引起雜聲。

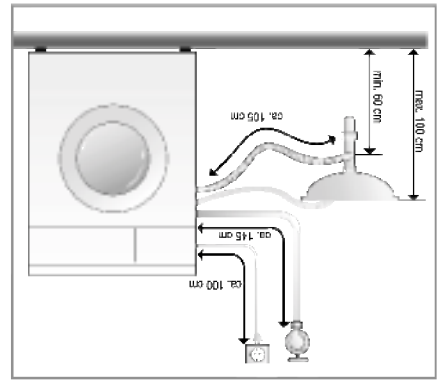
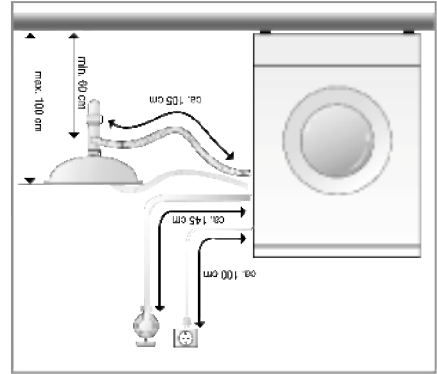

■ 安裝排水管

本產品並不適合在航海或其他流動地方使用，如在車隊或飛機上使用。
如長時間置閒洗衣機(如假期時)，特別是附近地面並無去水通道(溝渠)，請先關掉龍頭。棄置舊洗衣機時，請先切斷主電線及破壞插頭及弄壞門鎖，以免小孩被困在內。包裝物料(如膠膜或發泡膠)或會對小孩造成危險，它們或會引致窒息！請把包裝物料遠離小孩！

安裝

安裝

■ 一般水喉及無鎖紋螺絲入水喉

1. 鬆開固定的螺絲接駁水喉。

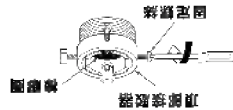

2. 將接駁器向上推，直至橡膠圈壓貼水喉。將4顆螺絲鎖緊。

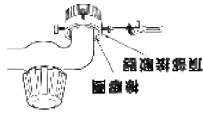

3. 將供水管垂直向上向推，直至水管內的橡膠圈完全壓貼水喉，將水管向右扭緊。

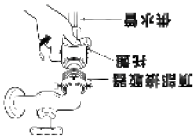

■ 一般水喉及無鎖紋即合水喉

1. 鬆開頂部接駁器螺絲。

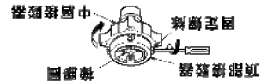

2. 將頂部接駁器向上推，直至橡膠圈壓貼水喉。將4顆螺絲鎖緊。

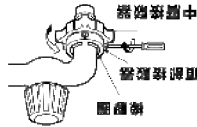

3. 將供水管接駁至中國接駁器，將托盤向下推。

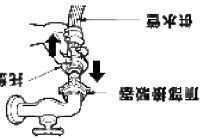

· 如水喉直徑較大請移除導入托盤。



· 將中國接駁器扭緊防止漏水。
· 確保橡膠圈在水管接駁器內。

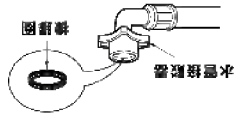

· 類分開供水管及中國接駁器，只需翻掉水喉，將托盤推下，拉下供水管便可。

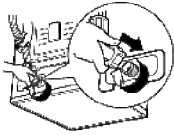

· 閣下的洗衣機只能接駁冷水。
· 確保水管沒有打結或擠壓。

使用垂直水喉



垂直水喉



伸延水喉



方型水喉

■ 接駁電源

1. 切勿使用伸縮電線或萬能插頭。
 2. 如電線已損壞，必須由生產商或其服務代理或合格技術員更換，以免發生危險。
 3. 每次使用洗衣機後，必須將電源及水源關上。
 4. 根據現行法例，閣下的洗衣機必須連接至接駁地線的插座上。
 5. 洗衣機必須放在方便閣下接駁插頭的地方。
- 必須由合資格人士，維修本洗衣機。由缺乏經驗的人士進行維修，或會造成人身損傷或令洗衣機出現嚴重故障，請聯絡當地的服務中心。
 - 切勿把洗衣機放在溫度或會低於冰點的地方。
 - 結了冰的喉管或會因受風而爆裂，而低於冰點的溫度，亦會降低電子控制組件的可靠性能。
 - 如在冬季或在低於冰點的溫度下搬運洗衣機，請先把洗衣機放在室溫下數小時，方可開始操作。

■ 洗衣機須接駁使用新水喉的水龍頭。

■ 接駁水喉水喉

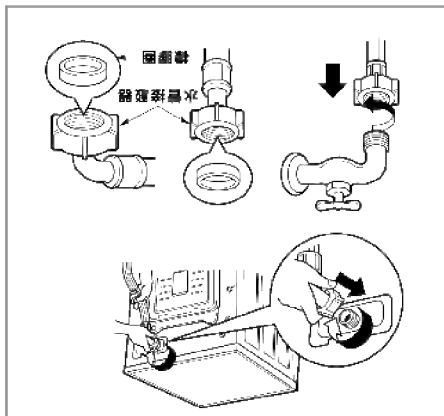

- ▶ 水壓必須在30kPa至1000kPa之間 (0.3~10kgf/cm²)
- ▶ 接駁入水管至活動時切勿讓活瓣鬆脫或移位。
- ▶ 如供水水壓超過1000kPa，請安裝減壓器。
- 為免漏水，我們在安裝前會檢查圖給閣下接駁水管用。
- 將水喉開出最大看水管接駁加否妥當。
- 定期檢查水管情況，如有損壞需它更換。
- 確保水管沒有打結及被壓。

由於電線顏色未必與插頭上的終端相同，請依照以下指示進行：
 黃及綠色電線必須接駁至刻有E字或⊕符號或線上黃線或綠色的終端。
 藍色電線必須接駁至刻有N字或線上黑色的終端。
 棕色電線必須接駁至刻有L字或線上紅色的終端。
 如使用13amp(BS1363)插頭，請使用3amp BS1362保險絲。

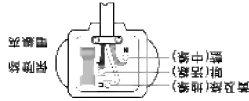

此機必須接地
 啡：活線
 藍：中線
 黃及綠：地線

此插頭的電線是根據以下規則着色：

重要

■ BS插頭安全鑰匙(適用於英國用戶)

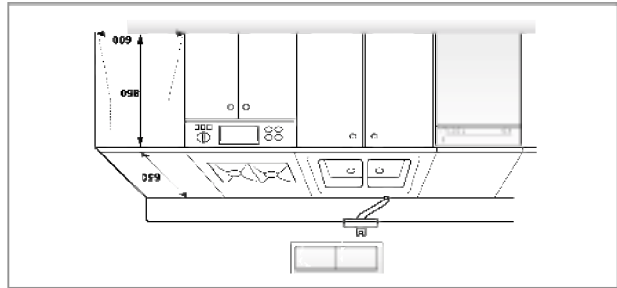

■ 安裝地點要求

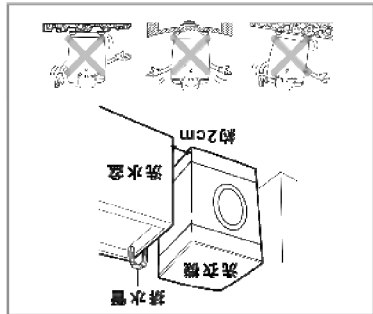

平地：許可斜度為1°。
電力輸出處：必須在洗衣機兩側1.5米範圍內，切勿接駁多於一件電器。
足夠空間：供貼牆、貼門及地面的洗衣機型號參考。
 (10cm：背部/2cm：右及左)
 任何時候均不可將衣物擺放或儲存在洗衣機頂部，這會損壞機身或操作裝置。

安裝

切勿將洗機放在剛安裝好的牆面或地板的渣滓上。

將洗機接線盒蓋以安全鎖鎖緊。

如將洗機放在地面上，切勿讓機器因震盪而空氣流通。

如可能出現蟻蟻或其他蟲患的地方使用本產品，請在任何時間，

均須確保洗機及周圍保持清潔。本產品的安裝，並不包括任何由蟻
蟲或其他蟲患造成的損毀。

■ 運輸螺栓

為防止搬運洗衣機時造成內部損壞，此機裝有運輸螺栓。

■ 拆緊運輸螺栓

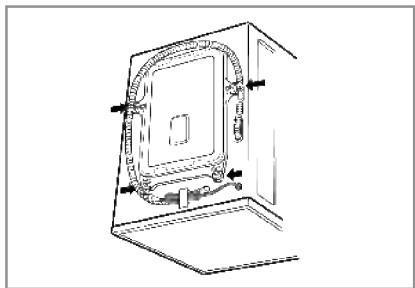

1. 為防止運輸時引起機器內部損壞，四個螺絲均被鎖上。使用洗衣機前，移除螺絲，只保留橡膠栓子。

如閣下不能將螺絲移除，會引起機身嚴重震動、噪音及故障。

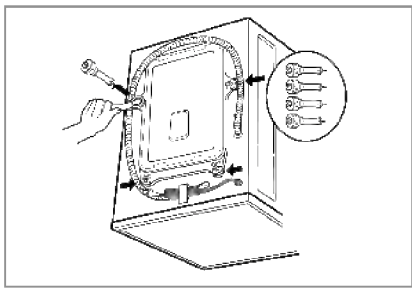

3. 將四個螺絲拿走，只保留橡膠栓子，只須將栓子輕輕扭曲便可。保留四個螺絲以便日後使用。

每次搬運洗衣機時，必須再次鎖上運輸螺絲。

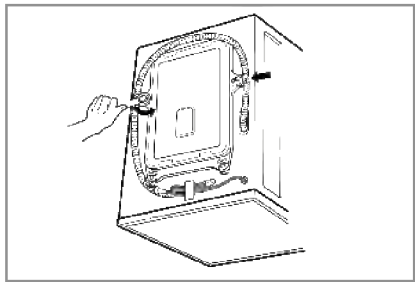

2. 利用扳鉗將螺絲鬆開。

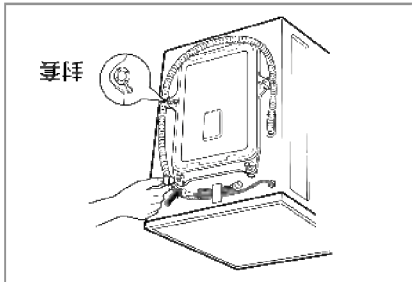

4. 利用我們提供的封套蓋著四個洞。

封套



WD-1016(0-9)SP/8016(0-9)SP/WD-1016(0-9)NP/6516(0-9)NP	前置式洗衣機	電能供應	220-240V~, 50Hz	
600 毫米(闊)×360 毫米(深)×850 毫米(高)	600 毫米(闊)×440 毫米(深)×850 毫米(高)	體積	55 公斤/2100 瓦	60 公斤/2100 瓦
42 公升	60 公升	耗水量	可容水壓	0.3-10kgf/cm ² (30-1000kPa)
不脫水 / 400 / 600 / 800 [WD-8016(0-9)SP/8016(0-9)NP]	不脫水 / 400 / 800 / 1000 [WD-1016(0-9)SP/1016(0-9)NP]	旋轉速度		

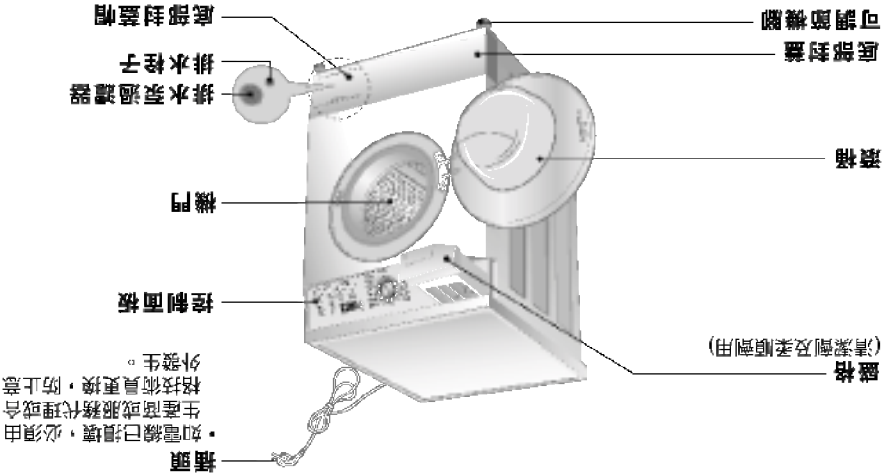

產品規格

警告

— 使用洗衣機前請細閱此說明書

警告! 為確保閣下安全，必須依照說明書指示，以減低火警或爆炸的危險，或防止人命或財產損失。

重要安全指南

警告：為減低火警、觸電，或人身受傷的危險，請依照以下基本預防措施：

- 切勿將洗衣機放在露天地方。
- 切勿擅自更改洗衣機裝置。
- 切勿更換或維修洗衣機任何部分。除用戶維修指南及修理指南內提供的建議外，切勿自行維修此機，維修時請確保閣下有足夠技巧進行。
- 確保洗衣機底部或附近沒有可燃物體如紗布、紙張、碎布、化學物品等。
- 如操作此機時有小孩在場，請加以看管。切勿讓小孩把玩洗衣機各部分或其他電器。
- 切勿讓洗衣機門長期開啟，這會令小童緊握機門或爬進洗衣機內。
- 切勿接觸操作中的洗衣機，應等待滾筒完全停止轉動。
- 洗衣程序會令衣物纖維的防火能力減低。

保留以下指南

接駁地線指南

此機必須接有地線。如機器出現故障，接有地線可以減少觸電危險。此機配備裝有接地導體的電線及接地插頭，插頭必須連接正規及接地的插座。

• 為防止接地插頭受損，切勿使用萬能插頭。

• 如閣下沒有正規插座，請聯絡技術員。

警告：接地導體接駁不正確會引起觸電，如有疑問，請聯絡技術員檢查閣下的電器是否接有地線。切勿更改供應商提供的插頭，如該插頭不適用於屋內的插座，請聯絡技術員安裝合適的插座。

警告	3
產品規格	4
安裝	5
洗衣前護理	11
加入清潔劑	12
功能	13
如何使用洗衣機	14
維修保養	21
解決問題指引	24

目錄

■ **自動重開**
如因電力供應問題而令洗衣機關掉，它能自動調節至停止時的位置重開繼續清洗。

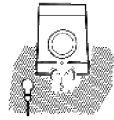

■ **低噪音速度控制系统**
此機能感應衣物數量及將衣物均勻擺放，減低衣物旋轉時的噪音。



■ **兒童保險鎖**
兒童保險鎖系統防止兒童在機器操作時接觸任何按鈕而改變清洗程式。

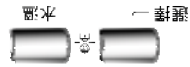

■ **智能洗衣系統洗衣更經濟**
智能洗衣系統能感應衣物數量及水溫，選擇適合水位及清洗時間，將水電消耗量減至最低。



產品細節



多則閣下選購LG全自動洗衣機。為確保閣下在安全的情況下安裝、
 使用及維修洗衣機，請細閱此說明書，並保留以便日後查閱。
 閣下洗衣機型號及在吊桶試記錄下來。

WD-6516(0~9)SP WD-8016(0~9)SP
 WD-8016(0~9)NP WD-1016(0~9)NP
 WD-6516(0~9)NP

洗衣機說明書

