



MINI HI-FI System

OWNER'S MANUAL

MODEL : LM-M245

(LM-M245A/D/X, LMS-M245)

Please read this manual carefully before operating your set.
Retain it for future reference.

Designs and specifications are subject to change without
notice for improvement.

The working life of this product is 7 years since the date
of purchase.



Precautions

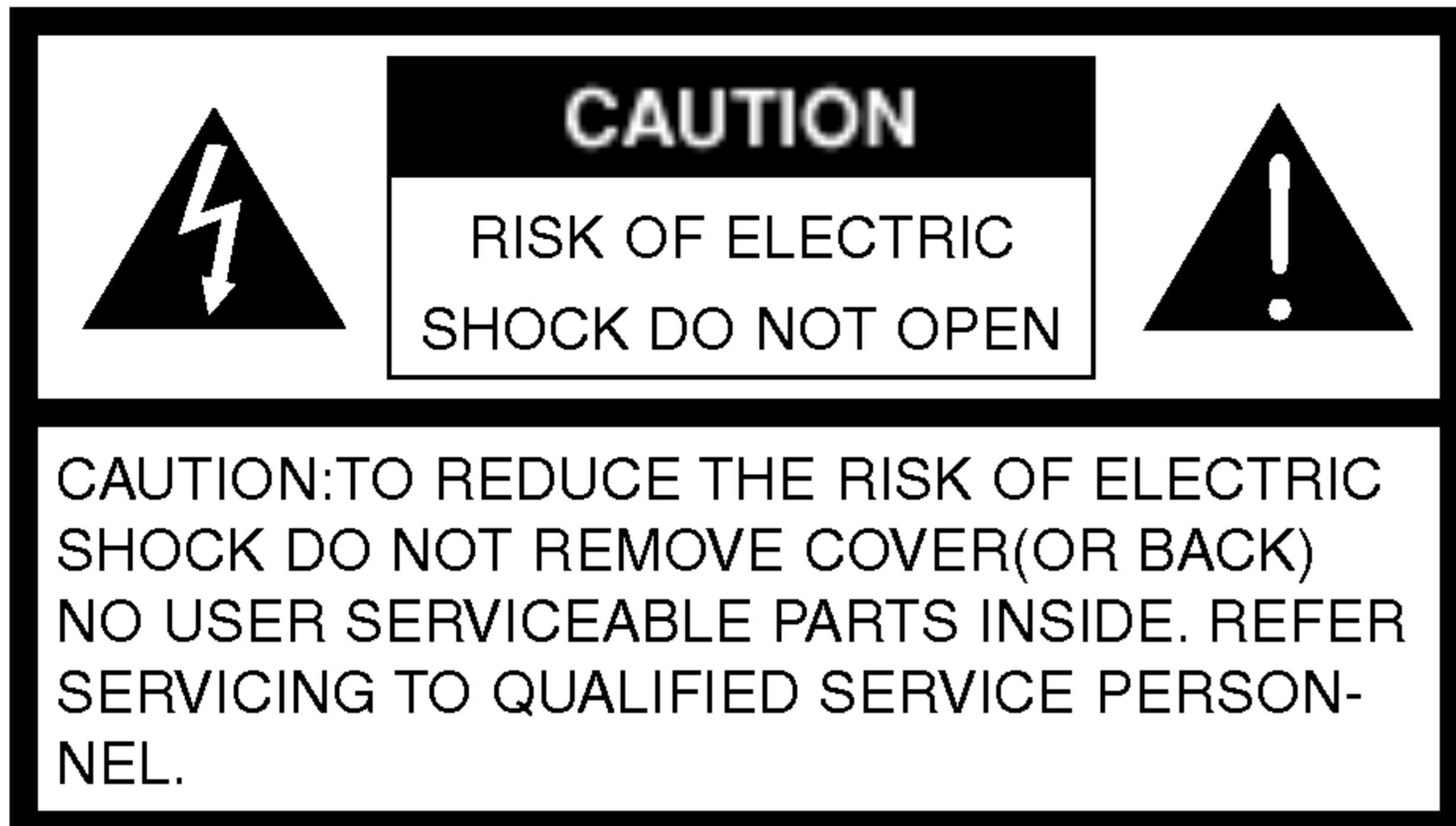

Explanation Graphical Symbols:



The lightning flash with arrowhead symbol, within an equilateral triangle is intended to alert the user to the presence of uninsulated dangerous voltage within the product's enclosure that may be of sufficient magnitude to constitute a risk of electric shock to persons.



The exclamation point within an equilateral triangle is intended to alert the user to the presence of important operating and maintenance (servicing) instructions in the literature accompanying the appliance.

WARNING

TO REDUCE THE RISK OF FIRE OF ELECTRIC SHOCK, DO NOT EXPOSE THIS APPLIANCE TO RAIN OR MOISTURE.

To avoid electrical shock, do not open the cabinet, Refer servicing to qualified personnel only.

The apparatus shall not be exposed to dripping or splashing and that no objects filled with liquids, such as vases, shall be placed on the apparatus.

Warning:

Do not install this equipment in a confined space such as a book case or similar unit.

CAUTION

Use of controls or adjustments or performance of procedures other than those specified herein may result in hazardous radiation exposure.

Laser component in this product is capable of emitting radiation exceeding the limit for Class 1.

CAUTION: INVISIBLE LASER RADIATION WHEN OPEN AND INTERLOCKS DEFEATED. AVOID EXPOSURE TO BEAM.

VARNING: OSYNLIG LASERSTRÅLNING NÄR DENNA DEL ÄR ÖPPNAD STRÅLEN ÄR FARLIG.

Attention: Quand l'appareil est ouvert, ne pas s'exposer aux radiations invisibles du faisceau laser.

This label is located on the interior.

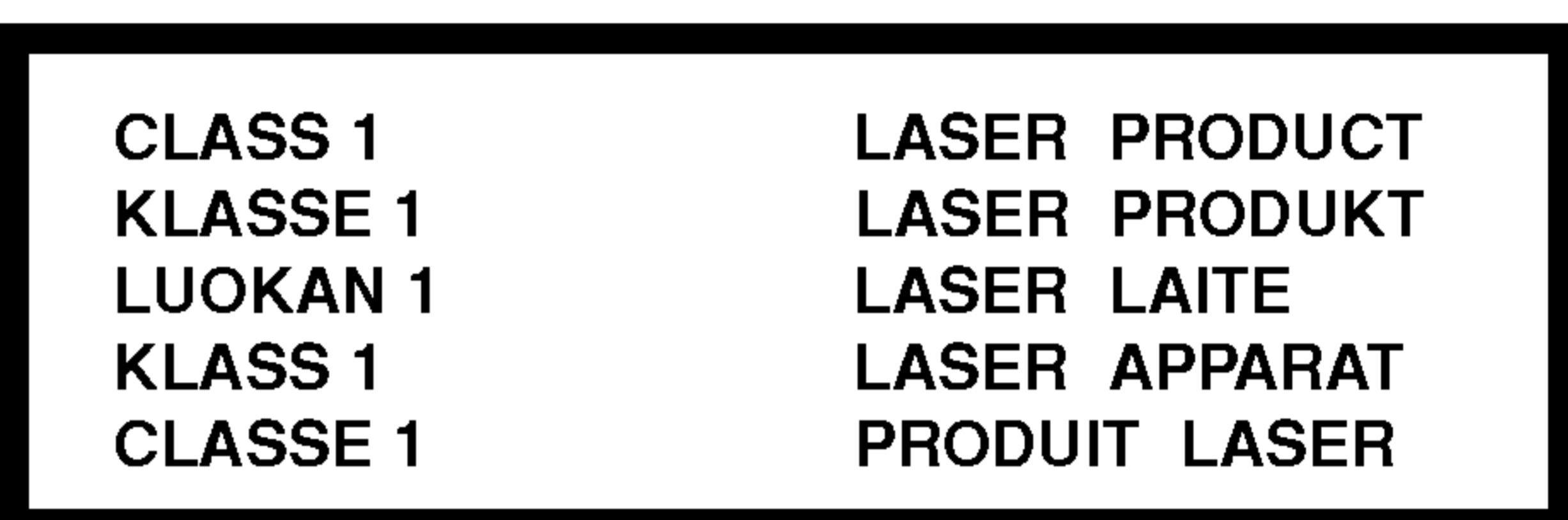

This Compact Disc player is classified as a CLASS 1 LASER product.

The CLASS 1 LASER PRODUCT label is located on the exterior.

Table of Contents

INTRODUCTION

| | |
|-------------------------------------|----------|
| Precautions | 2 |
| Table of Contents | 3 |
| Before Use | 4 |
| Safety Precautions | 4 |
| Notes on Discs | 4 |
| Notes on Remote Control | 4 |
| Notes on Tapes | 4 |
| Front Panel/Rear Panel | 5 |
| Remote Control | 6 |
| Display Window | 6 |
| Connections | 7 |
| Speaker System Connection | 7 |
| Antenna (Aerial) Connections | 7 |

BEFORE OPERATION

| | |
|---|------------|
| Audio Adjustment | 8-9 |
| Setting the Voltage (OPTIONAL) | 8 |
| Setting the CLOCK | 8 |
| Volume Adjustment | 8 |
| Sound Quality Adjustment | 8 |
| Sleep Function | 8 |
| MUTE | 8 |
| SURROUND | 8 |
| XDSS (Extreme Dynamic Sound System) | 8 |
| Timer Function | 9 |
| Auxiliary Function | 9 |
| RDS Function - OPTIONAL | 10 |
| About RDS | 10 |
| Programme Search (PTY) | 10 |



OPERATION

| | |
|---|--------------|
| Presetting the radio stations | 11 |
| Listening to the radio | 11 |
| Tape Playback | 12 |
| Basic Playback | 12 |
| To Stop Play | 12 |
| Tape Counter Reset | 12 |
| To Play Fast Rewind or Fast Forward | 12 |
| Dubbing | 12 |
| Recording | 12 |
| Basic Setting | 12 |
| Recording from Radio, CD or Auxiliary source .. | 12 |
| CD to Tape Synchronized Recording | 12 |
| CD Playback | 13-14 |
| Basic Playback | 13 |
| To Pause Play | 13 |
| To Stop Play | 13 |
| To Skip a Track | 13 |
| To Search a Track | 13 |
| To Go to the next discs | 13 |
| To Select a disc directly | 13 |
| To Replace discs during Playback | 13 |
| To check MP3 file information | 13 |
| To Repeat Play | 14 |
| To Program Play | 14 |

REFERENCE

| | |
|-------------------------------------|-----------|
| Troubleshooting | 15 |
| Additional Information | 15 |
| Specifications | |

About the symbols for instructions

-  Indicates hazards likely to cause harm to the unit itself or other material damage.
-  Indicates special operating features of this unit.
-  Indicates tips and hints for making the task easier.

Before Use

Safety Precautions

Handling the unit

When shipping the unit

The original shipping carton and packing materials come in handy. For maximum protection, re-pack the unit as it was originally packed at the factory.

To keep the surface clean

Do not use volatile liquids, such as insecticide spray, near the unit. Do not leave rubber or plastic products in contact with the unit for a long period of time. They will leave marks on the surface.

Cleaning the unit

To clean the cabinet

Use a soft, dry cloth. If the surfaces are extremely dirty, use a soft cloth lightly moistened with a mild detergent solution. Do not use strong solvents, such as alcohol, benzene, or thinner, as these might damage the surface of the unit.

Notes on Discs

Handling discs

Do not touch the playback side of the disc.
Hold the disc by the edges so that fingerprints will not get on the surface.
Do not stick paper or tape on the disc.

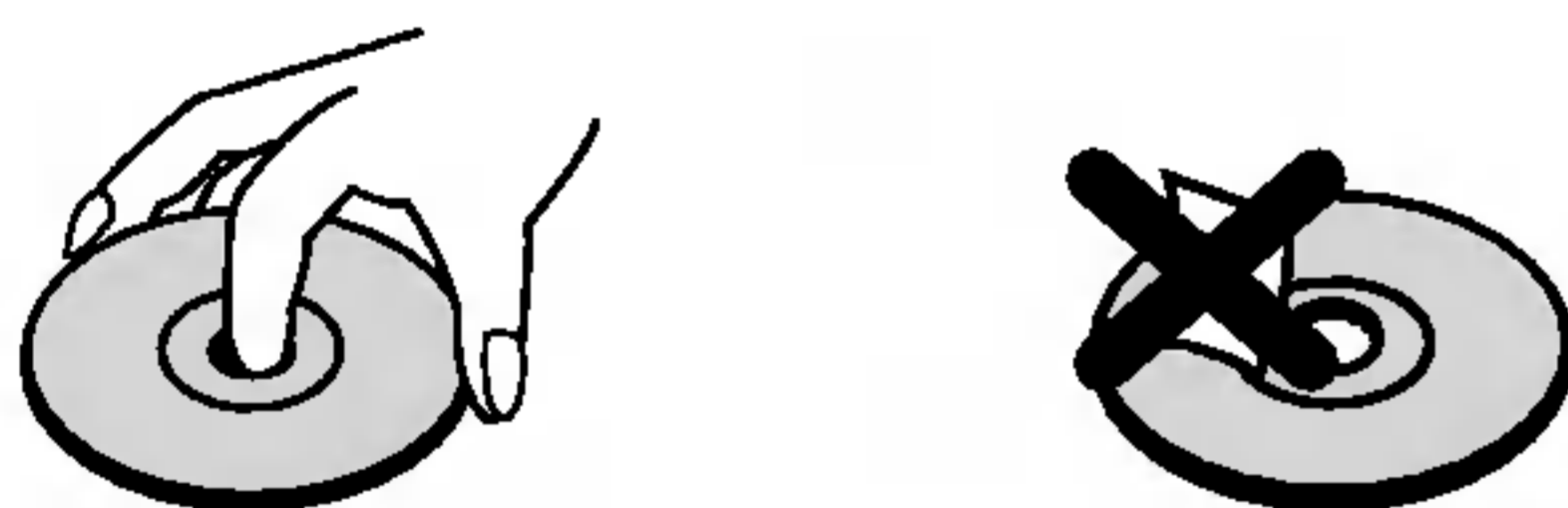

Storing discs

After playing, store the disc in its case.
Do not expose the disc to direct sunlight or sources of heat, or leave it in a parked car exposed to direct sunlight, as there may be a considerable temperature increase inside the car.

Cleaning discs

Fingerprints and dust on the disc can cause poor picture quality and sound distortion. Before playing, clean the disc with a clean cloth. Wipe the disc from the center out.

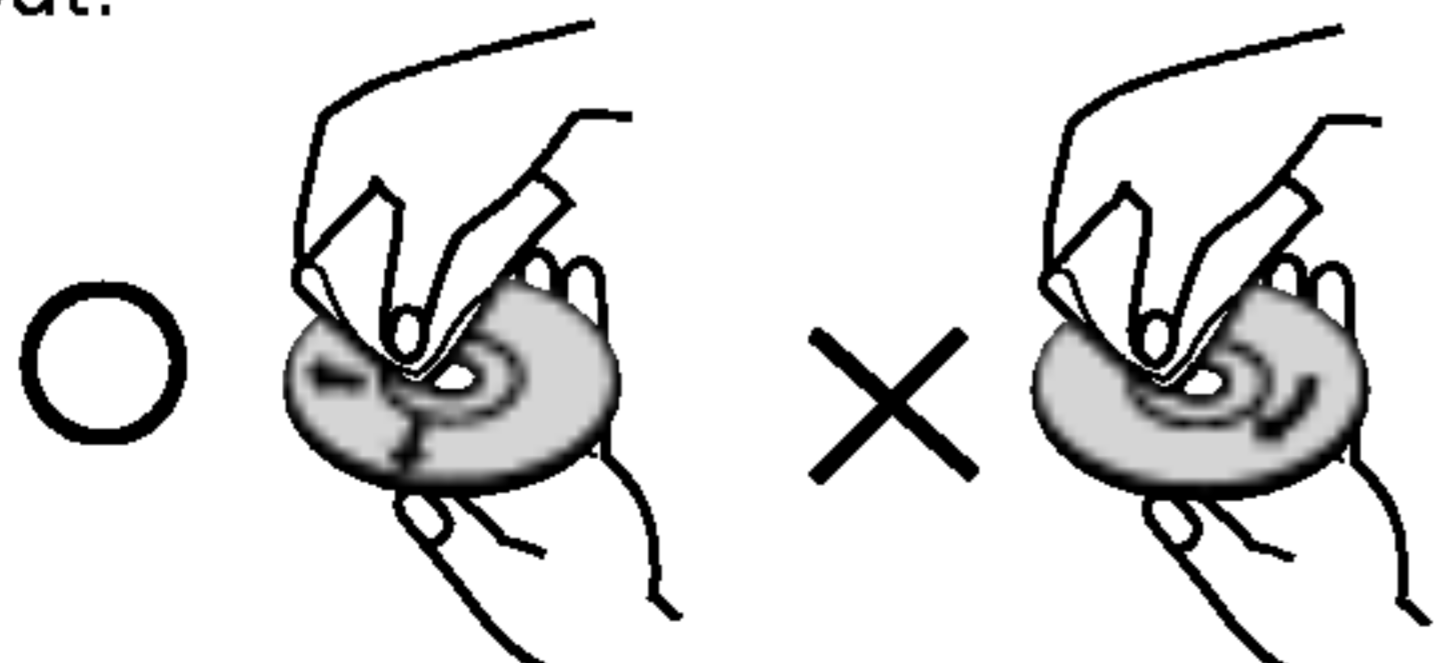

Do not use strong solvents such as alcohol, benzene, thinner, commercially available cleaners, or anti-static spray intended for analog records.

Notes on Remote Control

Remote Control Operation Range

Point the remote control at the remote sensor and press the buttons.

- **Distance:** About 23 ft (7 m) from the front of the remote sensor.
- **Angle:** About 30° in each direction of the front of the remote sensor.

Remote control battery installation

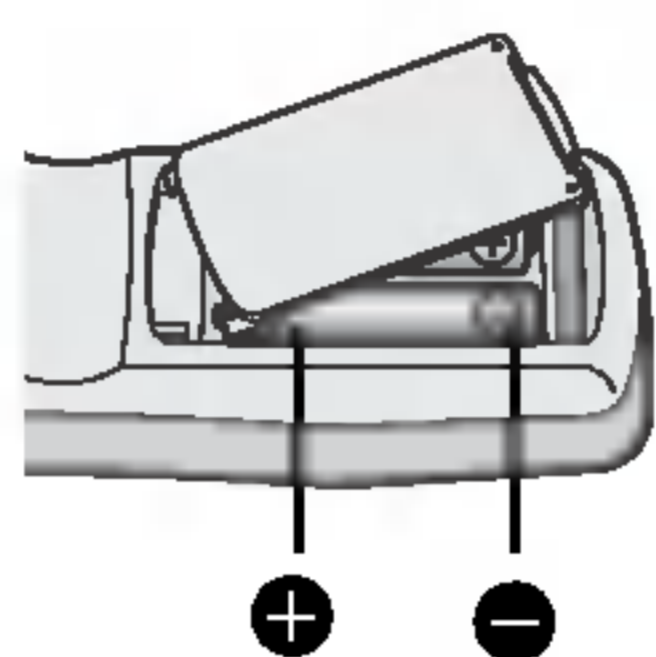

Detach the battery cover on the rear of the remote control, and insert two R03 (size AAA) batteries with \oplus and \ominus aligned correctly.

⚠ Caution

Do not mix old and new batteries. Never mix different types of batteries (standard, alkaline, etc.).

Notes on Tapes

Preventing record

Removing the tab(s) of the cassette (with a small screwdriver) will prevent accidental erasure.

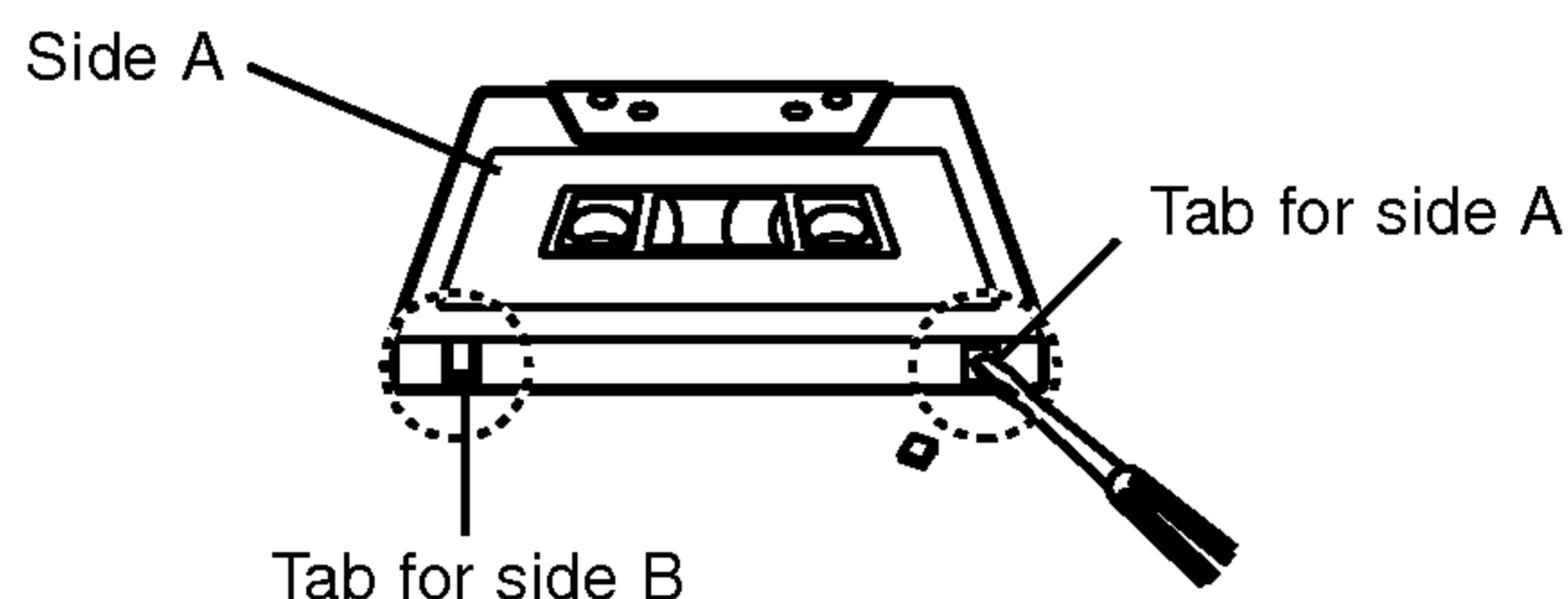

To record again, cover the hole of the tab with adhesive tape.

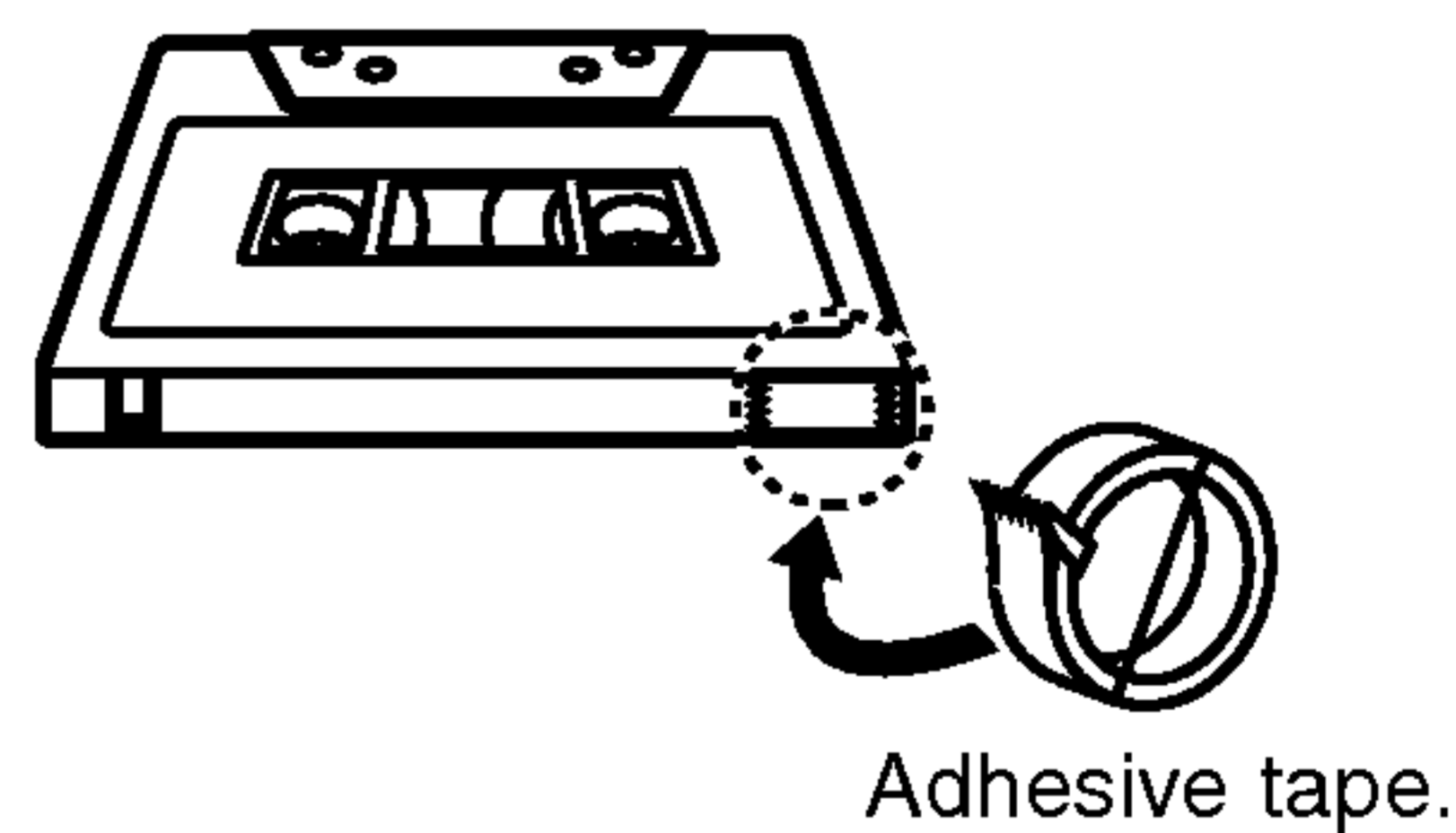

Front Panel/Rear Panel

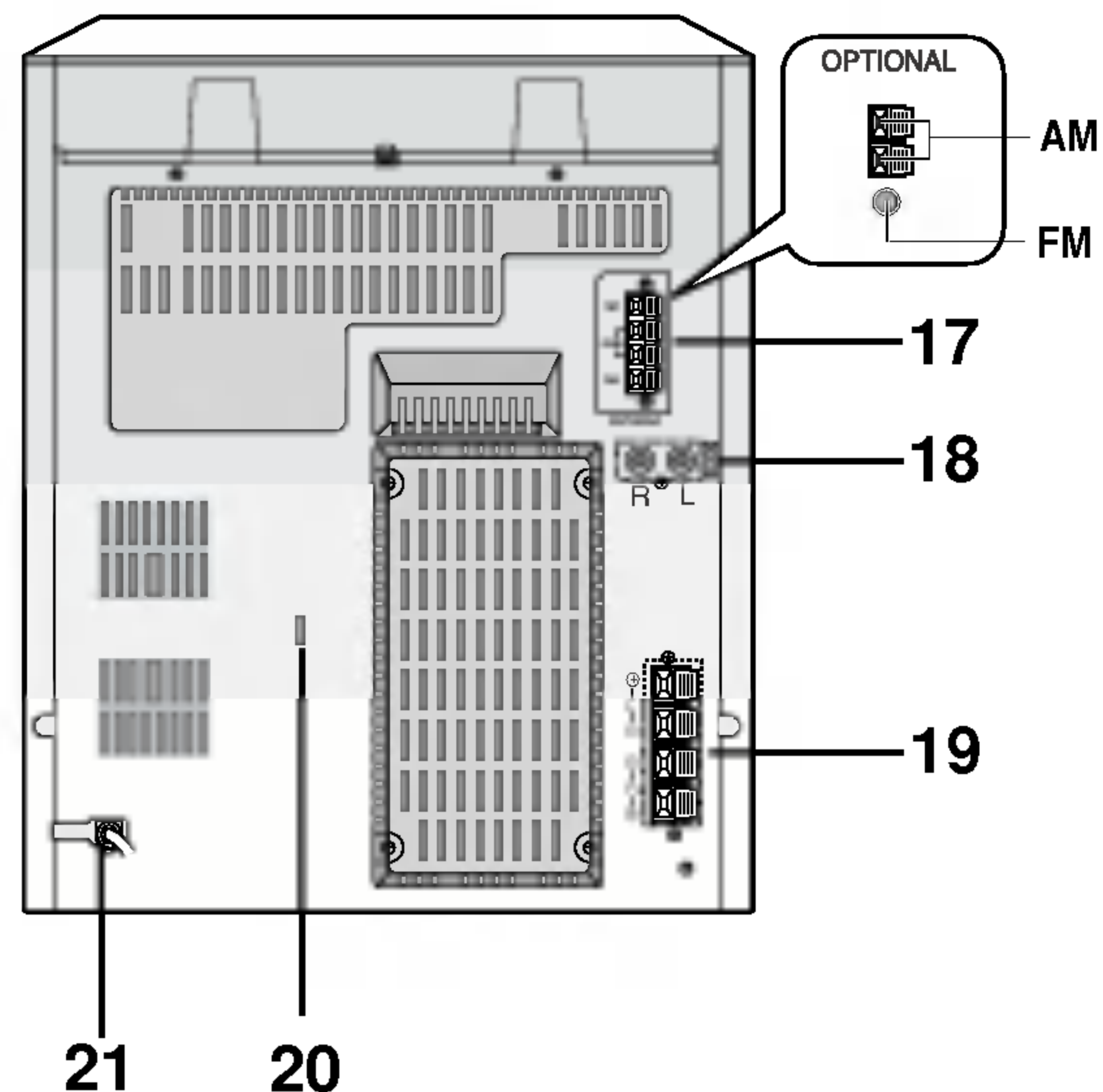
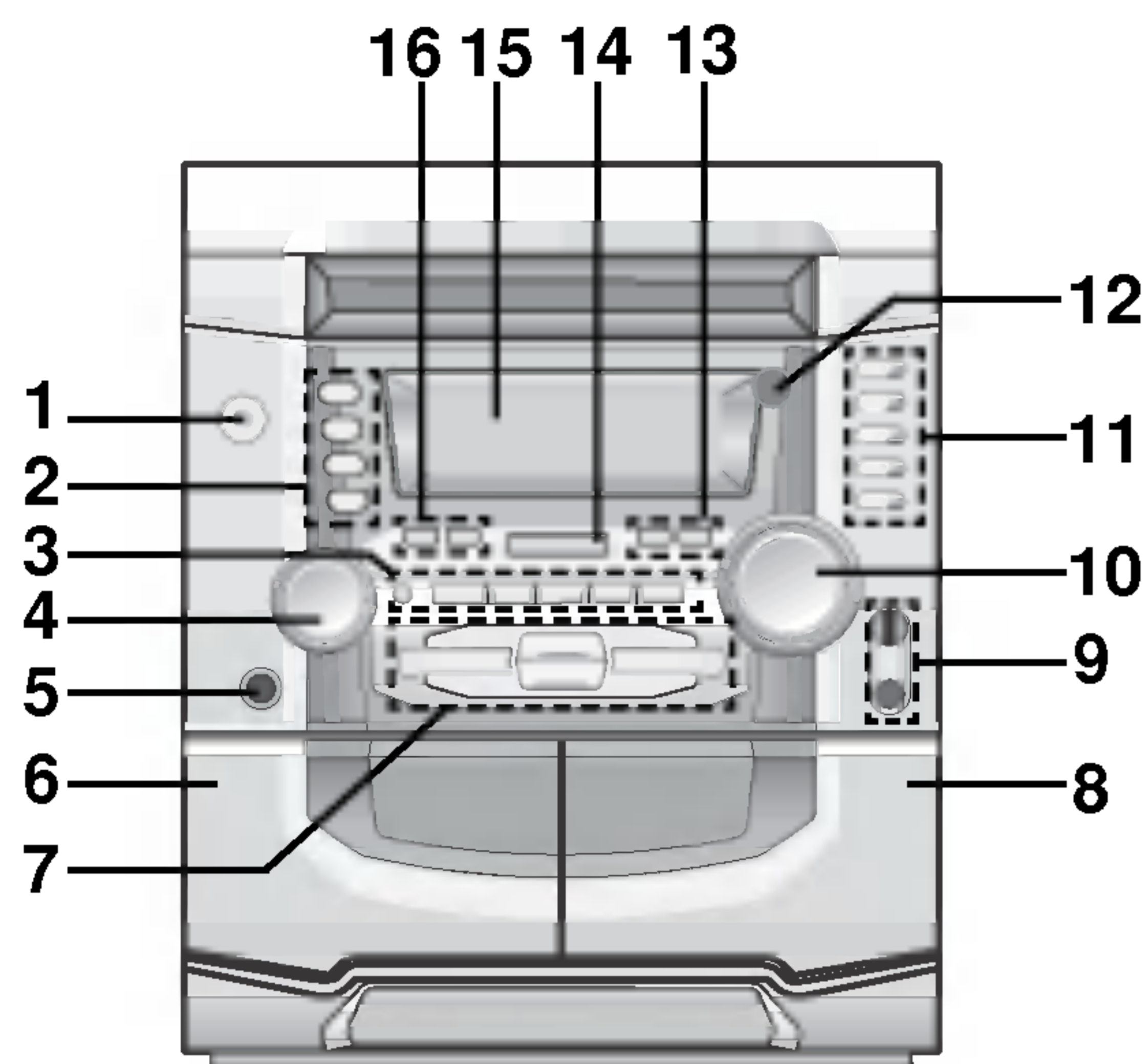

1. POWER (⏻ STANDBY/ON) button
2. • FM MODE/RIF button
• PROG./MEMO button
• CLOCK button
• TIMER button
3. • RDS button : OPTIONAL
• SET/CD PAUSE (CD II) button
• COUNTER RESET (COUNTER) button
• PLAY MODE button : OPTIONAL
• HIGH DUBBING button (HIGH-DUBBING)
• NORMAL DUBBING button (NOR-DUBBING)
• SURROUND button
• EQUALIZER (EQ) button
• CD SYNC. button
4. MULTI JOG SHUTTLE
5. HEADPHONE SOCKET (🎧 PHONES) - ϕ 6.3mm
6. ▲ PUSH EJECT position - TAPE 1 (DECK 1)
7. • REC/PAUSE (● /II) button
• TUNING (DOWN/UP) buttons
• PRESET (DOWN/UP) buttons
• CD SKIP/SEARCH (|◀◀◀◀ / ▶▶▶▶) buttons
• TAPE REWIND/FAST FORWARD (|◀◀◀◀ / ▶▶▶▶) buttons
• PLAY (▶) button
• REVERSE PLAY (◀) button : OPTIONAL
• STOP (■)/CLEAR button

8. ▲ PUSH EJECT position-TAPE 2 (DECK 2)
9. • MIC JACK (MIC) - ϕ 6.3mm : OPTIONAL
• MIC VOLUME KNOB (MIC VOL.) : OPTIONAL
10. VOLUME CONTROL KNOB
11. • CD OPEN/CLOSE (▲ OPEN/CLOSE) button
• DISC SKIP button
• DISC DIRECT PLAY buttons (DISC 1, DISC 2, DISC 3)
12. REMOTE SENSOR
13. • TAPE button
• AUX button
14. XDSS button
15. DISPLAY WINDOW
16. • TUNER/BAND button
• MP3/CD button
17. ANTENNA TERMINAL
18. AUXILIARY INPUT JACKS
19. SPEAKER TERMINAL
20. VOLTAGE SELECTOR SWITCH : OPTIONAL
21. POWER CORD

Remote Control

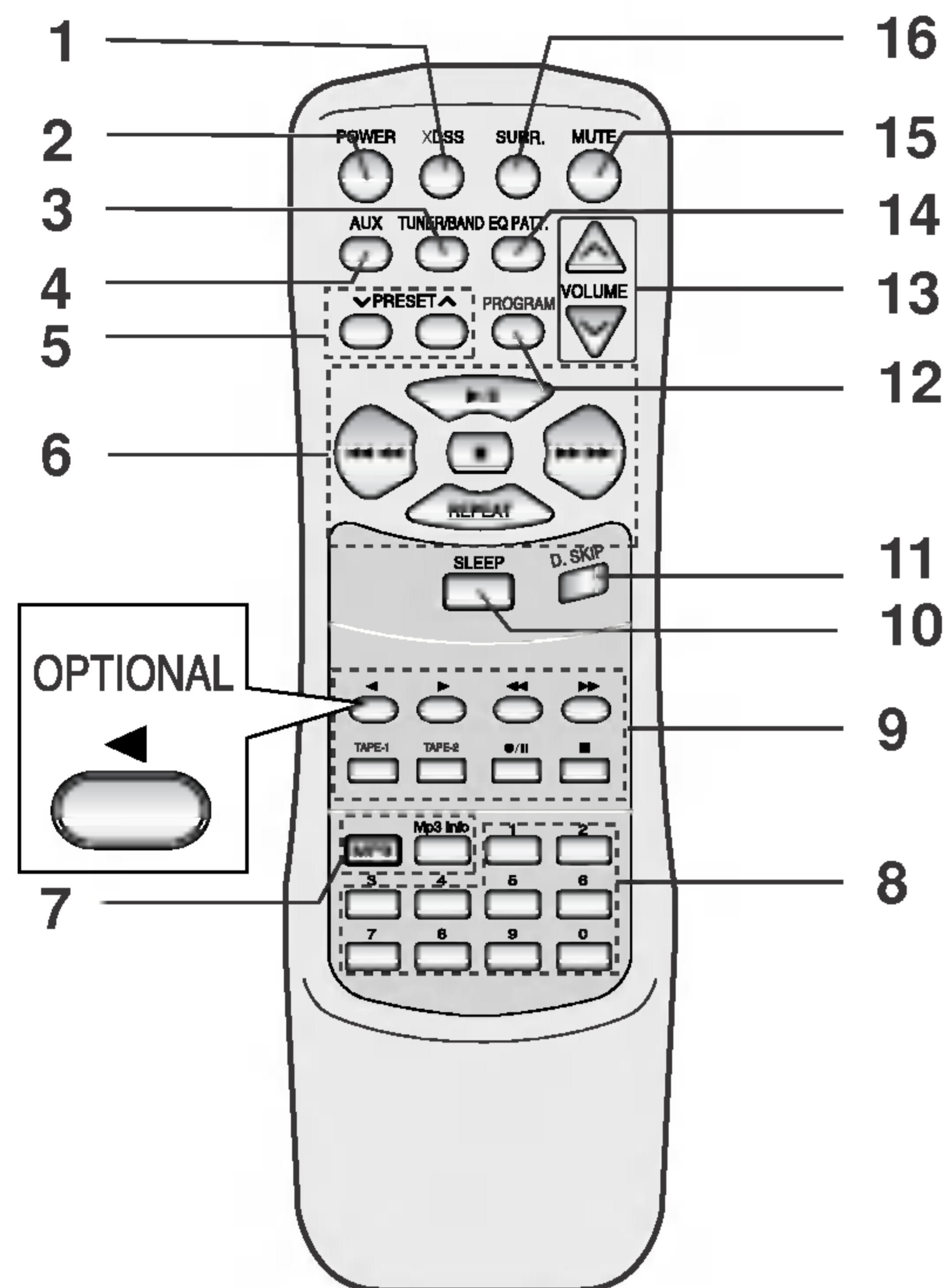

1. X-DSS button
2. POWER button
3. TUNER/BAND button
4. AUX button
5. PRESET (V/Λ) buttons
6. CD FUNCTION buttons
 - PLAY/ PAUSE (▶/||) button
 - CD STOP(■) button
 - CD SKIP/SEARCH (◀◀ ◀◀ / ▶▶ ▶▶) button
 - REPEAT button
7. MP3 file information display (Mp3 Info) button
8. NUMBER buttons
9. TAPE FUNCTION buttons
 - RECORD/ RECORD PAUSE (●/||) button
 - REVERSE PLAY (◀) button : OPTIONAL
 - FORWARD PLAY (▶) button
 - TAPE STOP button (■)
 - FAST FORWARD (▶▶) button
 - REWIND (◀◀) button
 - TAPE-1/2 SELECT button
10. SLEEP button
11. DISC SKIP (D.SKIP) button
12. PROGRAM button
13. VOLUME CONTROL (V/Λ) button
14. EQUALIZER PATTERN (EQ PATT.) button
15. MUTE button
16. SURROUND (SURR.) button

Display Window

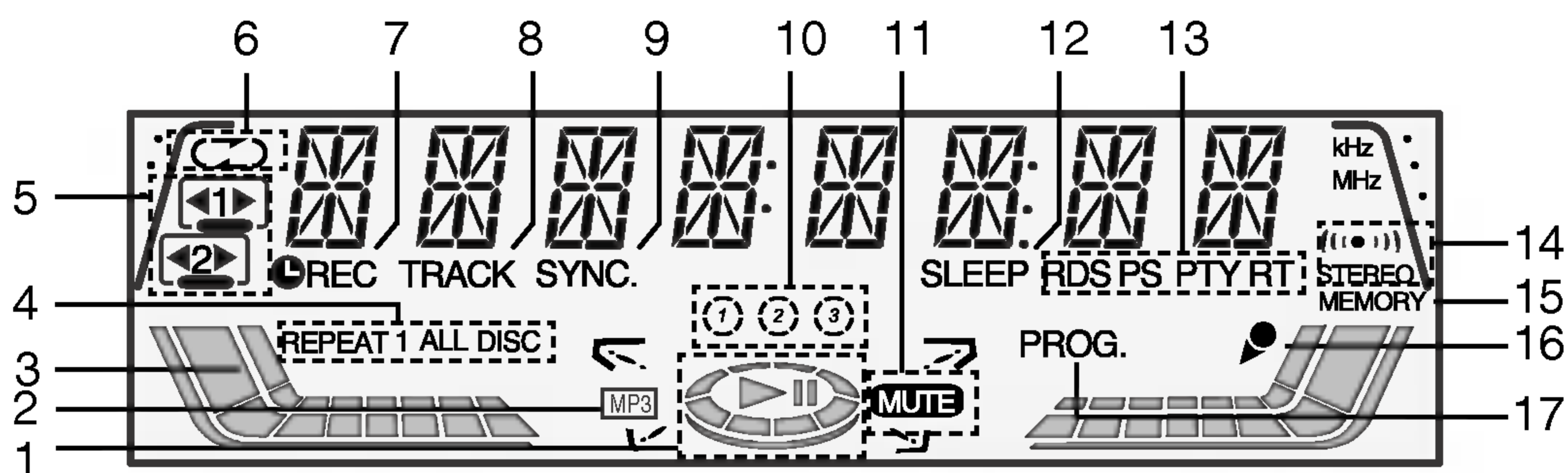

1. PLAY/PAUSE indicators
2. MP3 indicator
3. VOLUME indicator
4. CD REPEAT indicators
5. CASSETTE DECK indicators
6. PLAY MODE indicator - OPTIONAL
7. TIMER/RECORD indicator
8. TRACK indicator
9. CD SYNCHRO RECORDING indicator
10. DISC Number indicators
11. MUTE indicator
12. SLEEP indicator
13. RDS indicators - OPTIONAL
14. FM STEREO RECEIVING indicators
15. MEMORY indicator
16. MIC indicator - OPTIONAL
17. PROGRAM indicator

Connections

Speaker System Connection

Connect the speakers using the supplied speaker cords by matching the colors of the terminals and those of the cords. To obtain the best possible surround sound, adjust the speaker parameters (distance, level, etc.).

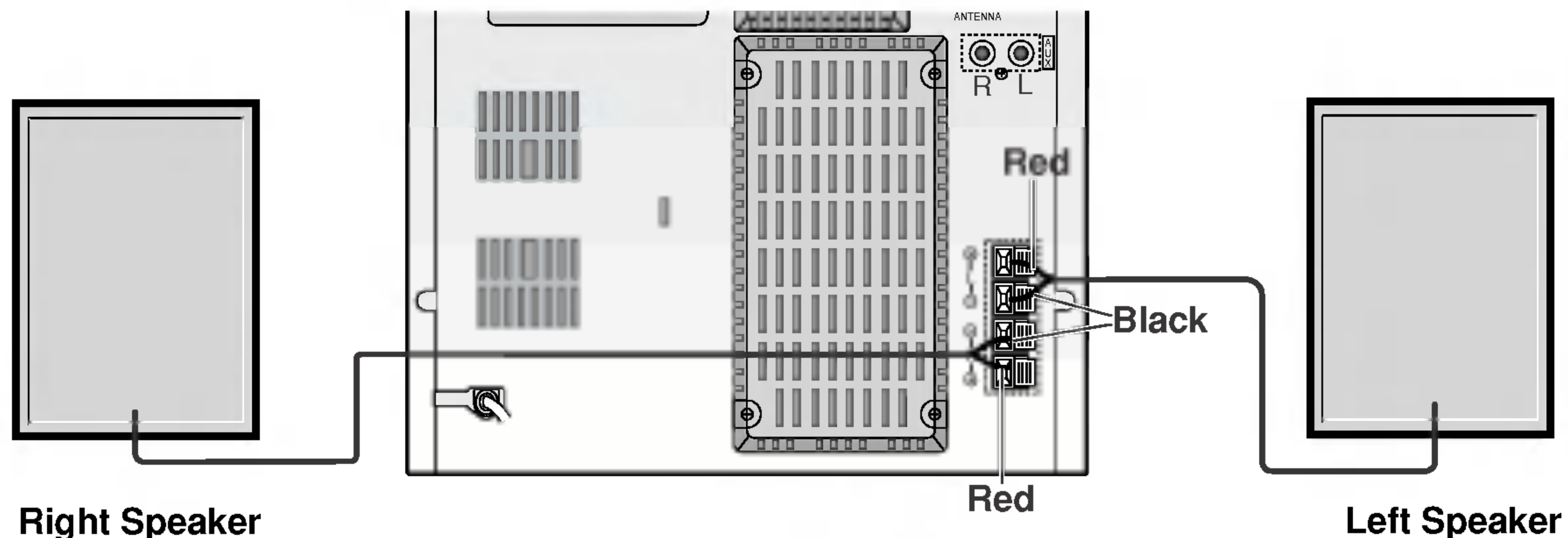

Notes

- Be sure to match the speaker cord to the appropriate terminal on the components: + to + and - to -. If the cords are reversed, the sound will be distorted and will lack base.
- If you use front speakers with low maximum input rating, adjust the volume carefully to avoid excessive output on the speakers.
- Do not disassemble the front cover of supplied speaker.

Antenna (Aerial) Connections

Connect the supplied FM/AM antennas for listening to the radio.

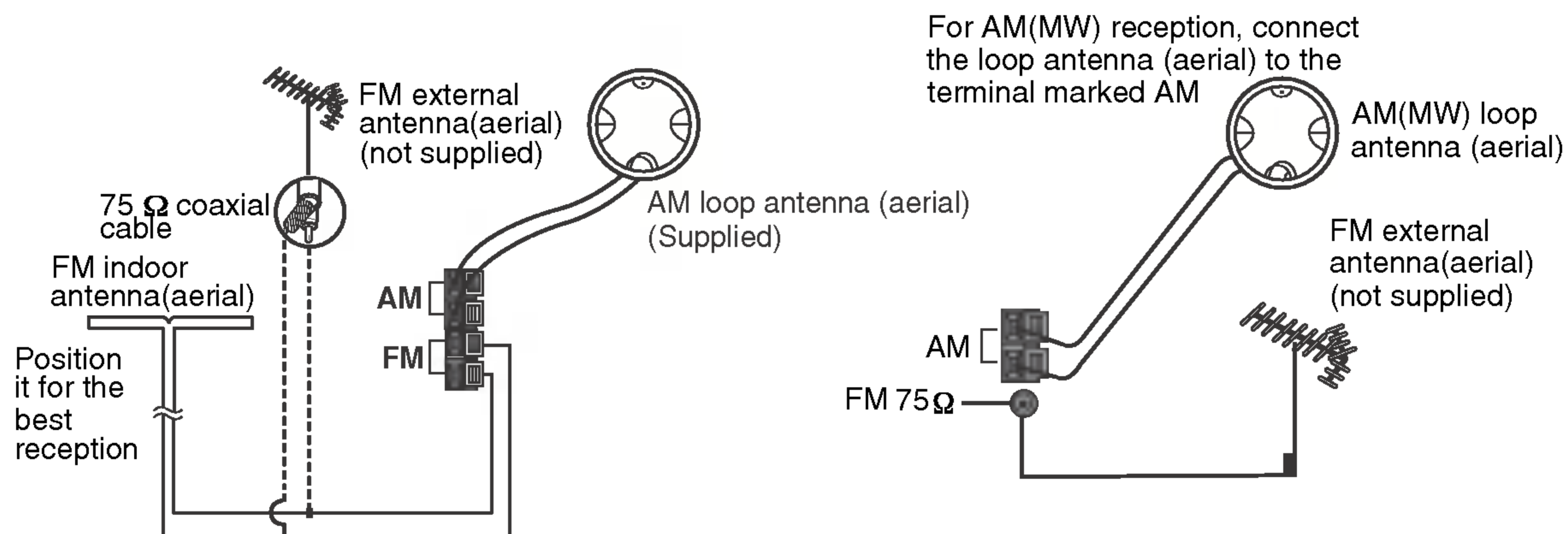

Notes

- To prevent noise pickup, keep the AM loop antenna away from the unit and other components.
- Be sure to fully extend the FM wire antenna.
- After connecting the FM wire antenna, keep it as horizontal as possible.

Audio Adjustment

Setting the voltage (OPTIONAL)

If your set is equipped with a voltage selector at the back side, be sure to set it to your local power supplied before connecting the AC power cord.

Setting the CLOCK

- 1 Press CLOCK.**
(If the clock requires setting, press and hold **CLOCK** for more than 2 seconds.)
- The hours begin to blink.
- 2 Select a 24 hour cycle or 12 hour cycle by pressing PRESET DOWN/UP or turning MULTI JOG SHUTTLE.**



(12HR)



(24HR)

- 3 Press SET to confirm the selected hour cycle.**
- 4 Use PRESET DOWN/UP or MULTI JOG SHUTTLE to set the correct hours.**
- 5 Press SET.**
- 6 Use PRESET DOWN/UP or MULTI JOG SHUTTLE to set the correct minutes.**
- 7 Press SET and the correct time is shown on the display.**
- 8 Press CLOCK at any time to display the time for about 3 seconds.**

Volume Adjustment

- Turn **VOLUME CONTROL KNOB** clockwise to increase the sound level, or counterclockwise to decrease it.
- Press **VOLUME (^)** to increase the sound level, or press the **VOLUME (V)** to decrease it on the remote control.

Sound Quality Adjustment

- **To activate stereo sound**
You can choose between 4 fixed sound impressions. Select a desired sound mode by using **EQ PATT.** button on the remote control or **EQ** button on the front panel.
FLAT : linear frequency response
ROCK : more bass, more treble
POP : less bass, less treble
CLASSIC : for orchestral music
- **Headphone Socket**
Connect a stereo headphone plug (∅ 6.3mm) into the headphone jack.
The speakers are automatically disconnected when you plug in the headphones (not supplied).

Sleep Function

When the sleep timer is used, the power is automatically turned off after the specified time has elapsed.

- 1 To specify the time delay before the power is turned off, press SLEEP.**
In the display window you can see *SLEEP 90* for about 5 seconds. This means that the system turns off automatically after 90 minutes. Each time the button is pressed the time interval before it turns off is reduced by 10 minutes. i.e. 80...70... etc.
Select the desired time to turn off.

- 2 To check the remaining time until the power is turned off.**
While the sleep function is active press **SLEEP** briefly. The time remaining until it turns off is displayed for about 5 seconds.

Note

If you press **SLEEP** while the sleep time is displayed, the **SLEEP** time is reset.

To cancel the sleep timer mode

If you wish to stop the function, press the **SLEEP** button repeatedly until **SLEEP 10** appears, and then press **SLEEP** once again while **SLEEP 10** is displayed.

MUTE

Press **MUTE** to mute your unit.
You can mute your unit in order, for example, to answer the telephone, "MUTE" indicator blinks in the display window.

SURROUND

To activate surround mode

Press **SURROUND** to reinforce surround effect.

SURROUND OFF ↔ SURROUND ON

XDSS (Extreme Dynamic Sound System)

Press **XDSS** to reinforce treble and bass.

The "XDSS ON" or "XDSS OFF" indicator lights up.

To cancel it press **XDSS** again.

Audio Adjustment

Timer Function

The unit can set the clock function in power on/off state. With the TIMER function you can have the radio reception and recording, CD play, tape play or auxiliary source play and recording turned on and off at the time desired.

- 1** Press **CLOCK** to check the current time.

For your reference

If you don't set clock, timer function doesn't work.

- 2** Press **TIMER** to enter the timer setting mode. TUNER-CD-TAPE flashes in the display window in turn.

For your reference

If you want to correct the previous memorized TIMER setting, press and hold the TIMER button more than 2 seconds.

- The previous memorized timer on time and TIMER indicators appear in the display.

- 3** Press **SET** when the desired function is blinking.

- 4**
 - 1. a. When you select the TUNER function,** 'PLAY' and 'REC' indicator blink in the display window alternately for about 3 seconds.
'PLAY' indicator : TUNER play only
'REC' indicator : TUNER play and recording
 - b. Select the previous memorized preset number with PRESET DOWN/UP button or MULTI JOG SHUTTLE and press SET.**
- 'ON TIME' indicator appears for about 0.5 seconds in the display window and then disappears.
- 2. When you select the CD or TAPE function,**
- 'ON TIME' indicator appears for about 0.5 seconds in the display window and then disappears.

- 5** Set the hour to switch on by pressing **PRESET DOWN/UP** or turning **MULTI JOG SHUTTLE**.

- 6** Press **SET** to confirm the hour to switch on.

- 7** Set the minute to switch on by pressing **PRESET DOWN/UP** or turning **MULTI JOG SHUTTLE**.

- 8** Press **SET** to confirm the minute to switch on. 'OFF TIME' indicator appears for about 0.5 seconds in the display window and then disappears.

- 9** Set the hour to switch off by pressing **PRESET DOWN/UP** or turning **MULTI JOG SHUTTLE**.

- 10** Press **SET** to confirm the hour to switch off.

- 11** Set the minute to switch off by pressing **PRESET DOWN/UP** or turning **MULTI JOG SHUTTLE**.

- 12** Press **SET**.

- 13** Adjust the volume level by pressing **PRESET DOWN/UP** or turning **MULTI JOG SHUTTLE**.

- 14** Press **SET**.
"⌚" appears in the display window and the timer setting has been completed.

- 15** Switch the system off.
The selected function is automatically switched on and off at the time set.

To cancel or check the timer

Each time the TIMER button is pressed you can select the timer set or cancel. You can also check the timer setting status.

To activate or check the timer, press the **TIMER**

button so that "⌚" appears in the display window.

To cancel the TIMER, press the **TIMER** button so that

"⌚" disappears in the display window.

Auxiliary Function

- 1** Connect an auxiliary device i.e. TV or VCR to the rear mounted AUX phone sockets.
- 2** Press **AUX**.

Note

You can also record from the auxiliary input source, see Recording Section.

RDS Function - OPTIONAL

About RDS

This unit is equipped with RDS (Radio Data System), which brings a wide range of information from FM radio. RDS is a system for transmitting station call signs or network information, a description of station programme type text message about the station or specifics of musical selection and the correct time.

RDS Tuning

When a FM station containing RDS data is tuned in, the unit will automatically display the station's call sign and the RDS indicator will light in the Display Window as well as indicators for the programme type recognition (PTY), Radio Text (RT), Clock Time (CT) and RDS service programme (PS) if transmitted by the station.

RDS Display Options

The RDS system is capable of transmitting a wide variety of information in addition to the initial call sign that appears when a station is first tuned. In normal RDS operation the display will indicate the station name, broadcast network or call letters. Pressing **RDS** on the front panel enables you to cycle through the various data types in the sequence:

(PS → FREQUENCY → PTY → RT → CT)

- **PTY (Programme type recognition)**- The programme type is shown on the display window.
- **RT (Radio text recognition)**- The radio station's name is displayed on the display window.
- **CT (Time controlled by the channel)**- Enable the unit to receive the actual time and show it on the display window.
- **PS (Programme Service name)**- The programme title is displayed on the display window.

Notes

- Some RDS stations may not choose to include some of these additional features. If the data required for the selected mode is not being transmitted, the Display Window will show a **PTY NONE, RT NONE, CT NONE, PS NONE** message.

Programme Search (PTY)

A major benefit of RDS is its ability to encode broadcasts with Programme Type (PTY) codes that indicate the type of material being broadcast. The following list shows the abbreviations used to indicate each PTY along with an explanation of the PTY.

| | |
|----------|---------------------------------|
| NEWS | News |
| AFFAIRS | Current Affairs |
| INFO | Information |
| SPORT | Sports |
| EDUCATE | Educational |
| DRAMA | Drama |
| CULTURE | Culture |
| SCIENCE | Science |
| VARIED | Varied Speech Programme |
| POP M | Popular Music |
| ROCK M | Rock Music |
| EASY M | Easy Listening Music |
| LIGHT M | Classical Music |
| CLASSICS | Serious Classical Music |
| OTHER M | Other Music |
| WEATHER | Weather Information |
| FINANCE | Financial Programmes |
| CHILDREN | Children's Programmes |
| SOCIAL | Social Affairs Programmes |
| RELIGION | Religious Broadcasts |
| PHONE IN | Phone-In Programmes |
| TRAVEL | Travel and Touring |
| LEISURE | Leisure and Hobby |
| JAZZ | Jazz Music |
| COUNTRY | Country Music |
| NATION M | National Music |
| OLDIES | Oldies Music |
| FOLK M | Folk Music |
| DOCUMENT | Documentary Programmes |
| TEST | Station Alarm Test Message |
| ALARM 1 | Emergency Broadcast Information |

You may search for a specific Programme Type (PTY) by following these steps:

- 1 Press TUNER/BAND to select FM mode.**
- 2 Select a desired station by pressing TUNING DOWN/UP.**
When the RDS transmission is received, the display shows the program service name (PS) after RDS indicator appears.
- 3 Press the RDS to select PTY mode.**
- 4 To search for a different PTY, press the PRESET DOWN/UP while the last PTY in use is still displayed to scroll through the list of available PTY types.**
- 5 When the PTY is selected, press the ◀◀◀ / ▶▶▶ within 5 seconds.**
The unit will go into an automatic search mode and attempt to find the next station with acceptable signal strength that matches the desired PTY type.

Presetting the radio stations

You can preset 30 stations for FM and AM. Before tuning, make sure that you have turned down the volume to the minimum.

- 1** Press **TUNER/BAND** to select the frequency (AM or FM) you want.
Every time you press this button, AM and FM changes alternately.
- 2** Press **TUNING DOWN/UP** on the front panel until the frequency indication starts to change.

Notes

- **Automatic Tuning**

Press **TUNING DOWN/UP** for more than 0.5 seconds.
- Scanning stops when the unit tunes in a station.

- **Manual Tuning**

Press **TUNING DOWN/UP** briefly and repeatedly.

- 3** Press **PROG./MEMO** on the front panel or **PROGRAM** on the remote control.
A preset number will flash in the display window.
- 4** Press **PRESET DOWN/UP** (or **PRESET (∇/∧)** on the remote control) to select the preset number you want.

- 5** Press **PROG./MEMO** on the front panel or **PROGRAM** on the remote control.
- The station is stored.

- 6** Repeat steps 2 to 5 to store other stations.

To clear all the memorized stations

Press and hold **PROG./MEMO** on the front panel for about two seconds, "CLEAR" appears on the display window and then press **CLEAR**, the stations are cleared.

For your reference

If all stations have already been entered, FULL message will appear in the display window for a moment and then a preset number will blink. To change the preset number, follow the steps 4-5.

To recall presets

Press and hold **PRESET DOWN/UP** (or **PRESET (∇/∧)** on the remote control) until the desired preset number appears or press it repeatedly.

Listening to the radio

- 1** Press **TUNER/BAND** to select the frequency (AM or FM) you want.
Every time you press this button, AM and FM changes alternately.
The last received station is tuned in.
- 2** Press **PRESET DOWN/UP** (or **PRESET (∇/∧)** on the remote control) repeatedly to select the preset station you want.
- Each time you press the button, the unit tunes in one preset station at a time.
- 3** Adjust the volume by rotating **VOLUME CONTROL KNOB** (or pressing **VOLUME (∇/∧)** on the remote control) repeatedly.

To listen to non-preset radio stations

- Use manual or automatic tuning in step 2.
- For automatic tuning, press and hold **TUNING DOWN/UP** on the front panel.

To turn off the radio

Press **POWER** to turn the unit off or select another function mode (MP3/CD, TAPE or AUX).

For your reference

- **If an FM program is noisy**
Press **FM MODE/RIF** so that "STEREO" disappears on the display window. There will be no stereo effect, but the reception will be improved. Press **FM MODE/RIF** again to restore the stereo effect.
- **To improve reception**
Repose the supplied antennas.

Notes

- Use **FM MODE/RIF** (Radio Interference Filter) function to switch to mono reception if stereo reception is distorted by noise.
- When recording the MW(AM) or LW broadcast, beat noises may occur. If it does, press **FM MODE/RIF** once.

Tape Playback

Basic Playback

- 1** Press TAPE 1/2 to select TAPE 1 or TAPE 2.
(“NO TAPE” appears in the display window.)
- 2** Open cassette TAPE 1 (or 2) by pushing **▲ PUSH EJECT** position.
- 3** Insert one or two cassette with the tape side to the bottom and then close the TAPE 1 (or 2).
- 4** Press PLAY (▶ or ◀: OPTIONAL).

AUTO STOP DECK (TAPE 1/2)

After auto stop deck plays only front side, the unit stops automatically.

AUTO REVERSE DECK (TAPE 2): OPTIONAL

You can select direction of the cassette you want by pressing **PLAY MODE**.

| Pressing | Display | Function |
|-------------|---------|--|
| Once | | After the cassette plays front or reverse(backward play) side, stops automatically. |
| Twice | | After the cassette plays front and reverse side, stops automatically. |
| Three times | | After the cassette plays six times repeatedly front and reverse side, stops automatically. |

To Stop Play

Press **STOP(■)/CLEAR** on the front panel or **TAPE STOP(■)** on the remote control during playback.

Tape Counter Reset

Press **COUNTER** during playback.

Playing time appears “TP 1(or 2) 0000” in display window.

To Play Rewind or Fast Forward

After pressing **◀◀ ◀◀ / ▶▶ ▶▶** on the front panel or **◀◀ / ▶▶** on the remote control during playback, press **PLAY (▶)** in the point you want.

Dubbing

This function shows how to record from tape to tape.

- 1** Press TAPE 1/ 2.
 - Cassette TAPE 1- Insert a playback tape to dub.
 - Cassette TAPE 2- Insert a blank tape.

- 2** Press **NORMAL/ HIGH DUBBING** as follow.

| Pressing | Display | Function |
|--------------|-----------------|----------------------|
| NOR-DUBBING | <i>NOR DUBB</i> | Normal speed dubbing |
| HIGH DUBBING | <i>HI DUBB</i> | Double speed dubbing |

To stop recording, press **STOP(■)**.

Recording

Wind the tape to the point recording starts. Use only normal tapes. You can record from cassette deck 2 only.

Basic Setting

- 1** Press **MP3/CD** or **TUNER/BAND**.
- 2** Open the cassette TAPE 2 and insert a blank cassette into the cassette compartment.
Set the recording direction : OPTIONAL
Press **PLAY MODE** repeatedly to set the recording direction.

| Pressing | Display | Function |
|----------|---------|-----------------------------------|
| Once | | Recording front side. |
| Twice | | Recording front and reverse side. |
| Third | | |

Recording from Radio, CD or Auxiliary source

- 1** Press **●/||** on the front panel.
“REC” blinks and holds the cassette in pause mode.
- 2** Press **PLAY(▶)** on the front panel.
The recording begins.

To Pause recording

To pause the recording, press **●/||** on front panel or **●/||** on the remote control again.
“REC” flashes in display window.

To Stop recording

Press **TAPE STOP(■)**.

CD to Tape Synchronized Recording

The CD synchro recording function dubs a complete CD and programmed titles automatically into a cassette.

- 1** Press **CD SYNC**. in stop mode.
“REC” blinks and “*CD SYNC*” is lit on the display window.
- 2** The synchronized recording is started automatically after about 7 seconds.

Note

- If you wish to record the desired track, select the desired track with **◀◀ ◀◀ / ▶▶ ▶▶** before commencing CD synchro recording.

CD Playback

Basic Playback

- 1 Press **⏻** STANDBY/ON(POWER) to turn on the unit.
- 2 Press the MP3/CD button on the front panel to enter the CD mode.
If no disc is entered in the disc drawer, "NO DISC" indicator is displayed.
- 3 Press CD OPEN/CLOSE(**▲** OPEN/CLOSE) and place the disc into the disc tray.
The disc on the left (DISC 1) is played first.

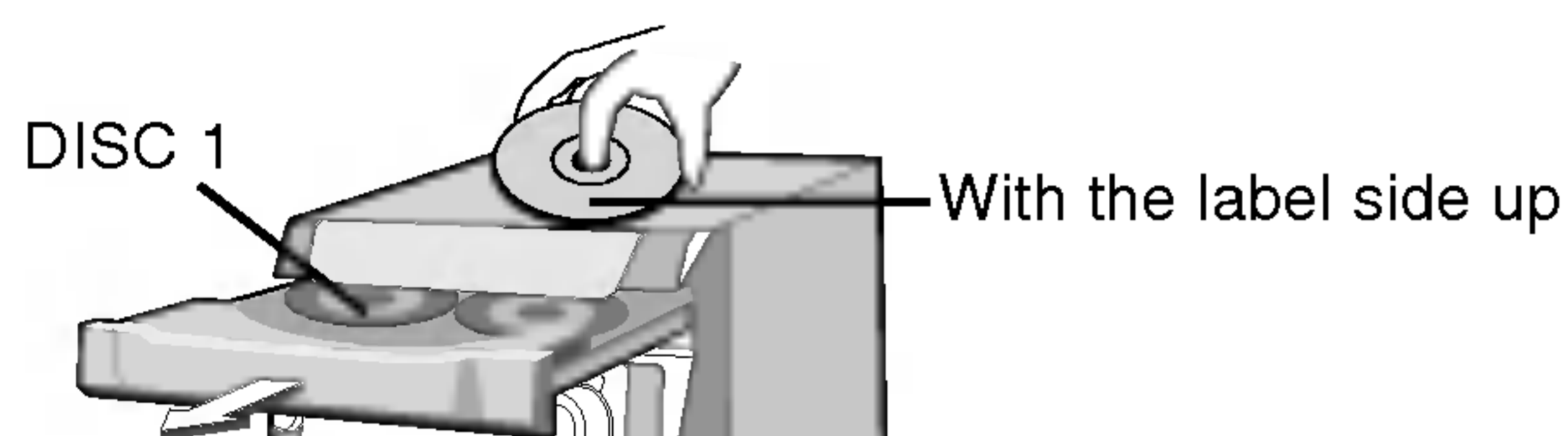

Note

To load an 8cm(3 inch) disc, put it onto the inner circle of the tray.

- 4 Press CD OPEN/CLOSE(**▲** OPEN/CLOSE) to close the disc compartment.
Audio CD: "READING" appears in the display window, and then the total number of tracks and the playing time are displayed.
MP3 CD: "READING" appears in the display window, and then the total number of files are displayed.
- 5 Press PLAY(**▶**) on the front panel or CD PLAY/PAUSE (**▶/||**) on the remote control.
In addition, you can also play an Audio CD or MP3 CD using the NUMBER buttons.

To Pause Play

Press CD PAUSE (CD**||**) on the front panel or CD PLAY/PAUSE (**▶/||**) on the remote control during playback.

Press this button again it to resume play.

To Stop Play

Press STOP(**■**)/CLEAR on the front panel or CD STOP(**■**) on the remote control during playback.

To Skip a Track

- Press **▶▶ ▶▶** button to go to the next track.
- When **◀◀ ◀◀** button is pressed once midway through a track, the player returns to the start of that track. When it is pressed again, a track is skipped each time the button is pressed.

To Search a Track

After pressing and holding **◀◀ ◀◀ / ▶▶ ▶▶** button on the remote control during playback, then release at the point you want.

To Go to the next discs

Press DISC SKIP on the front panel or D.SKIP on the remote control during playing or stopping.

To Select a disc directly

Press DISC 1, DISC 2 or DISC 3 during playing or stopping.

When you press DISC 1-3 before playing a disc, the unit will automatically start playing the selected disc.

To Replace discs during Playback

You can open the disc tray during playing a disc to check what discs are to be played next and replace discs without interrupting playback of the current disc.

- 1 Press the CD OPEN/CLOSE (**▲** OPEN/CLOSE).
The disc tray is opened. Two disc compartments appear. Even if the unit is playing a disc, it doesn't stop playing.
- 2 Replace discs in the compartments with new ones.
The unit plays the disc in the left compartment after the current disc, and then the one in the right compartment.
- 3 Press CD OPEN/CLOSE (**▲** OPEN/CLOSE).
The CD door is closed.

Notes

- Do not place more than one compact disc on one disc tray at the same time.
- Do not push the disc tray to close CD door, as you may damage the unit.

To check MP3 file information

Press the **MP3 Info** button during MP3 file playback.

- The information (Title, Artist or Album) of the MP3 file will be shown in the display window.
- If there is no the information of the MP3 file, "NO ID3 TAG" indicator will be shown in the display window.

CD Playback

To Repeat Play

To play one track repeatedly

Press **REPEAT** once during playback.

- "REPEAT 1" appears in the display window.

To play one disc repeatedly

Press **REPEAT** again during playback.

- "REPEAT 1 DISC" appears in the display window.

To play all tracks on all discs repeatedly

Press **REPEAT** once more during playback.

- "REPEAT ALL DISC" appears in the display window.

To cancel repeat play







- Press **REPEAT** several times until repeat indicator disappear.

Program repeat play

- Press **REPEAT** once during program play.
 - "REPEAT 1" appears in the display window.
(One track repeat)
- Press **REPEAT** again during program play.
 - "REPEAT 1 DISC" appears in the display window.(All program repeat)

To Program Play

You can arrange the order of the tracks on the discs and create your own program. The program can contain up to 20 tracks.

- 1** Press **PROG./MEMO** on the front panel or **PROGRAM** on the remote control on the stop mode.
- 2** Press **DISC SKIP** or **DISC DIRECT PLAY (DISC1/2/3)** on the front panel or **D.SKIP** on the remote control to select the disc.
- 3** Press **CD SKIP/ SEARCH**   /   on the front panel or on the remote control to select the track.
- 4** Press **PROG./MEMO** on the front panel or **PROGRAM** on the remote control.
- 5** Repeat steps 1~4.
- 6** Press **PLAY**  on the front panel or **CD PLAY/ PAUSE**   on the remote control.

To check program contents

Press **PROG./MEMO** (or **PROGRAM** on the remote control) on the stop mode.

- The disc, track and program number will be displayed.

To clear program contents

Press **PROG./MEMO** (or **PROGRAM** on the remote control) on the stop mode. And then press **CLEAR** on the front panel or **CD STOP**  on the remote control.

To add program contents

1. Press **PROG./MEMO** (or **PROGRAM** on the remote control) repeatedly on the program stop mode until "Disc Number" blinks.
2. Repeat 2~5.

To modify program contents

1. Press the **PROG./MEMO** (or **PROGRAM** on the remote control) to display program number you want to modify.
2. Repeat 2~4.

Troubleshooting

Check the following guide for the possible cause of a problem before contacting service.

| Symptom | Cause | Correction |
|--|--|---|
| No power. | <ul style="list-style-type: none"> The power cord is disconnected. | <ul style="list-style-type: none"> Plug the power cord into the wall outlet securely. |
| No sound. | <ul style="list-style-type: none"> The audio cables are not connected securely. | <ul style="list-style-type: none"> Connect the audio cable into the jacks securely. |
| | <ul style="list-style-type: none"> The power of the external source equipment is switched off. | <ul style="list-style-type: none"> Turn on the equipment connected with the audio cable. |
| | <ul style="list-style-type: none"> The speaker cable is set to the wrong position. | <ul style="list-style-type: none"> Set the speaker cable to the correct position, then turn on the unit again by pressing POWER. |
| The unit does not start playback. | <ul style="list-style-type: none"> No disc or tape is inserted. | <ul style="list-style-type: none"> Insert a disc or tape. |
| | <ul style="list-style-type: none"> An unplayable disc or tape is inserted. | <ul style="list-style-type: none"> Insert a playable disc or tape. |
| | <ul style="list-style-type: none"> The disc is placed upside down. | <ul style="list-style-type: none"> Place the disc with the playback side down. |
| | <ul style="list-style-type: none"> The disc is not placed within the guide. | <ul style="list-style-type: none"> Place the disc on the disc tray correctly inside the guide. |
| | <ul style="list-style-type: none"> The disc is dirty. | <ul style="list-style-type: none"> Clean the disc. |
| The remote control does not work properly. | <ul style="list-style-type: none"> The remote control is not pointed at the remote sensor of the unit. | <ul style="list-style-type: none"> Point the remote control at the remote sensor of the unit. |
| | <ul style="list-style-type: none"> The remote control is too far from the unit. | <ul style="list-style-type: none"> Operate the remote control within about 23 ft (7 m). |
| | <ul style="list-style-type: none"> There is an obstacle in the path of the remote control and the unit. | <ul style="list-style-type: none"> Remove the obstacle. |
| | <ul style="list-style-type: none"> The batteries in the remote control are exhausted. | <ul style="list-style-type: none"> Replace the batteries with new ones. |

Additional Information

About MP3

- An MP3 file is audio data compressed by using the MPEG1 audio layer-3 file-coding scheme. We call files that have the ".mp3" file extension "MP3 files".
- The unit can not read an MP3 file that has not ".mp3" file extension.

MP3 Disc compatibility with this unit is limited as follows:

- Sampling Frequency / 8 - 48kHz
- Bit rate / 8 - 320kbps
- CD-R physical format should be "ISO 9660"
- If you record MP3 files using the software which cannot create a FILE SYSTEM, for example "Direct-CD" etc., it is impossible to playback MP3 files. We recommend that you use "Easy-CD Creator", which creates an ISO9660 file system.

- File names should be named using 30 letters or less and must incorporate ".mp3" extension e.g. "*****.MP3".
- Do not use special letters such as "/ : * ? " < > " etc.
- Even if total number of files on the disc have more than 1000, it will only shown up to 999.

About MULTI SESSION

- This function recognizes the multi session disc according to a disc of CD-ROM type.
- ex) If there is MP3 files in the first session, the MP3 file in the first session is only played.
If there is only MP3 file in the whole session, all of the MP3 file in the each session is played.
If there is Audio CD in the first session, the Audio CD in the first session is only played.

Specifications

| | | | |
|------------|---------------------------------|--------------------------------------|---|
| [General] | Power supply | Refer to the back panel of the unit. | |
| | Power consumption | 50 W | |
| | Mass | 6.6 kg | |
| | External dimensions (W x H x D) | 273 x 330 x 360 mm | |
| [CD] | Frequency response | 40 - 18000 Hz | |
| | Signal-to-noise ratio | 70 dB | |
| | Dynamic range | 70 dB | |
| [Tuner] | FM | Tuning Range | 87.5 - 108.0 MHz or 65 - 74 MHz, 87.5 - 108.0 MHz |
| | | Intermediate Frequency | 10.7 MHz |
| | | Signal to Noise Ratio | 60/55 dB |
| | | Frequency Response | 60-10000 Hz |
| | AM (MW) | Tuning Range | 522 - 1611 kHz or 530 - 1610 kHz |
| | | Intermediate Frequency | 450 kHz |
| | | Signal to Noise Ratio | 35 dB |
| | | Frequency Response | 100 - 1800 Hz |
| [Amp] | Output Power | 20 W + 20 W | |
| | T.H.D | 0.15 % | |
| | Frequency Response | 40 - 25000 Hz | |
| | Signal-to-noise ratio | 80 dB | |
| [TAPE] | Tape Speed | 4.75 cm/sec | |
| | Wow Flutter | 0.25 % (MTT -111, JIS-WTD) | |
| | F.F/REW Time | 120 sec (C-60) | |
| | Frequency Response | 250 - 8000Hz | |
| | Signal to Noise Ratio | 43 dB | |
| | Channel Separation | 50 dB(P/B)/45dB(R/P) | |
| | Erase Ratio | 55 dB (MTT-5511) | |
| [Speakers] | Type | 2 Way 2 Speaker | |
| | Impedance | 6 Ω | |
| | Frequency Response | 60 - 18000 Hz | |
| | Sound Pressure Level | 85 dB/W (1m) | |
| | Rated Input Power | 20 W | |
| | Max. Input Power | 40 W | |
| | Net Dimensions (W x H x D) | 200 X 326 X 185 mm | |
| | Net Weight | 2.31 kg | |

* Designs and specifications are subject to change without notice.