



MINI HI-FI System

OWNER'S MANUAL

MODEL : LM-U1350

(LM-U1350A/D/X, LMS-U1350)

LM-U1050

(LM-U1050A/D/X, LMS-U1050)

LM-W550

(LM-W550A/D/X, LMS-W550)

LM-U550

(LM-U550A/D/X, LMS-U550)

Please read this manual carefully before operating your set.
Retain it for future reference.

Designs and specifications are subject to change without
notice for improvement.



Precautions



CAUTION: THESE SERVICING INSTRUCTIONS ARE FOR USE BY QUALIFIED SERVICE PERSONNEL ONLY. TO REDUCE THE RISK OF ELECTRIC SHOCK DO NOT PERFORM ANY SERVICING OTHER THAN THAT CONTAINED IN THE OPERATING INSTRUCTIONS UNLESS YOU ARE QUALIFIED TO DO SO.



Caution: The apparatus should not be exposed to water (dripping or splashing) and no objects filled with liquids, such as vases, should be placed on the apparatus.

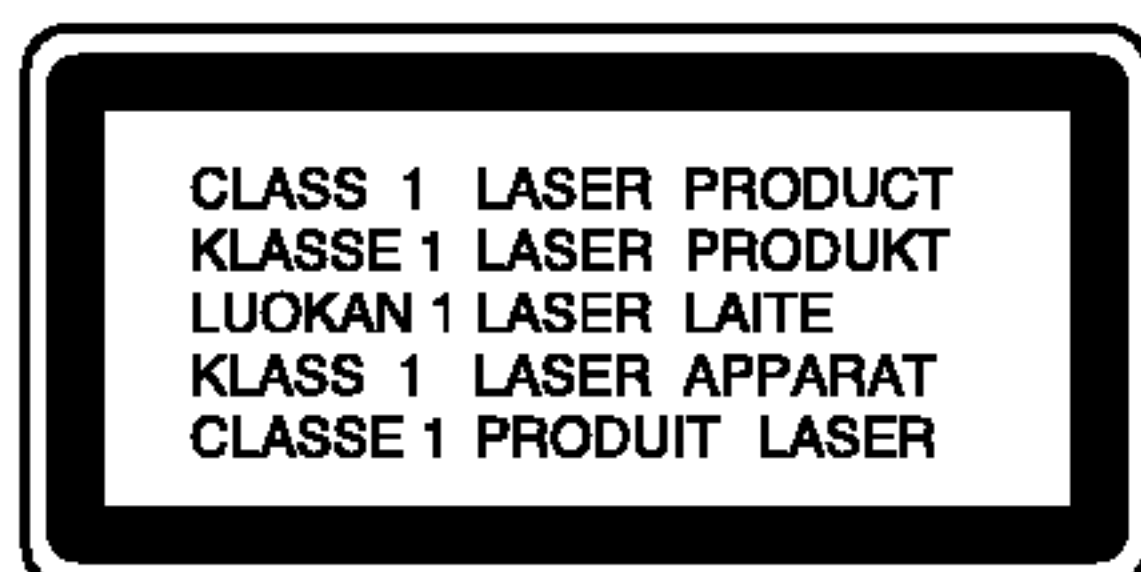

CAUTION: This product employs a Laser System.

To ensure proper use of this product, please read this owner's manual carefully and retain for future reference. Should the unit require maintenance, contact an authorized service center.

Use of controls, adjustments, or the performance of procedures other than those specified herein may result in hazardous radiation exposure.

To prevent direct exposure to laser beam, do not try to open the enclosure. Visible laser radiation when open. DO NOT STARE INTO BEAM.



WARNING: Do not install this equipment in a confined space such as a bookcase or similar unit.

CAUTION concerning the Power Cord

Most appliances recommend they be placed upon a dedicated circuit;

That is, a single outlet circuit which powers only that appliance and has no additional outlets or branch circuits. Check the specification page of this owner's manual to be certain.

Do not overload wall outlets. Overloaded wall outlets, loose or damaged wall outlets, extension cords, frayed power cords, or damaged or cracked wire insulation are dangerous. Any of these conditions could result in electric shock or fire. Periodically examine the cord of your appliance, and if its appearance indicates damage or deterioration, unplug it, discontinue use of the appliance, and have the cord replaced with an exact replacement part by an authorized servicer.

Protect the power cord from physical or mechanical abuse, such as being twisted, kinked, pinched, closed in a door, or walked upon. Pay particular attention to plugs, wall outlets, and the point where the cord exits the appliance.



This product is manufactured to comply with the radio interference requirements of EEC DIRECTIVE 89/336/EEC, 93/68/EEC and 73/23/EEC.

Table of Contents

INTRODUCTION

Precautions	2
Table of Contents	3
Before Use	4
Safety Precautions	4
Notes on Discs	4
Notes on Remote Control	4
Notes on Tapes	4
Front Panel/Rear Panel	5
Remote Control	6
Connections	7
Speaker System Connection	7
Antenna (Aerial) Connections	7

BEFORE OPERATION

Audio Adjustment	8-10
Setting the Voltage (OPTIONAL)	8
Setting the CLOCK	8
Volume Adjustment	8
Sound Quality Adjustment	8
Sleep Function	8
MUTE	9
SURROUND	9
XDSS (Extreme Dynamic Sound System)	9
DISPLAY MODE	9
DIMMER	9
DEMO	9
OAO (Orientaion Acoustic Optmizer)	9
XTS-Pro	9
MP3 OPTIMIZER	9
Timer Function	10
Auxiliary Function	10
RDS Function - OPTIONAL	11
About RDS	11
Programme Search (PTY)	11



OPERATION

Presetting the radio stations	12
Listening to the radio	12
Tape Playback	13
Basic Playback	13
To Stop Play	13
To Play Rewind or Fast Forward	13
Dubbing	13
Recording	13
Basic Setting	13
Recording from Radio, CD, USB or Auxiliary source	13
CD to Tape Synchronized Recording	13
CD Playback	14-15
Basic Playback	14
To Pause Play	14
To Stop Play	14
To Skip a Track	14
To Search a Track	14
To Go to the next discs	14
To Select a disc directly	14
To Replace discs during Playback	14
To check MP3 file information	14
To Repeat Play	15
To Program Play	15
Connecting USB Port	16
USB device Playback	16-17
Basic Playback	16
To Pause Play	16
To Stop Play	16
To Go to the next cards	16
To Skip a Track	16
To check MP3 file information	16
To Repeat Play	17
To Program Play	17

REFERENCE

Troubleshooting	18
Additional Information	18
Specifications	19

About the symbols for instructions

-  Indicates hazards likely to cause harm to the unit itself or other material damage.
-  Indicates special operating features of this unit.
-  Indicates tips and hints for making the task easier.

Before Use

Safety Precautions

Handling the unit

When shipping the unit

The original shipping carton and packing materials come in handy. For maximum protection, re-pack the unit as it was originally packed at the factory.

To keep the surface clean

Do not use volatile liquids, such as insecticide spray, near the unit. Do not leave rubber or plastic products in contact with the unit for a long period of time. They will leave marks on the surface.

Cleaning the unit

To clean the cabinet

Use a soft, dry cloth. If the surfaces are extremely dirty, use a soft cloth lightly moistened with a mild detergent solution. Do not use strong solvents, such as alcohol, benzene, or thinner, as these might damage the surface of the unit.

Notes on Discs

Handling discs

Do not touch the playback side of the disc.
Hold the disc by the edges so that fingerprints will not get on the surface.
Do not stick paper or tape on the disc.



Storing discs

After playing, store the disc in its case.
Do not expose the disc to direct sunlight or sources of heat, or leave it in a parked car exposed to direct sunlight, as there may be a considerable temperature increase inside the car.

Cleaning discs

Fingerprints and dust on the disc can cause poor picture quality and sound distortion. Before playing, clean the disc with a clean cloth. Wipe the disc from the center out.

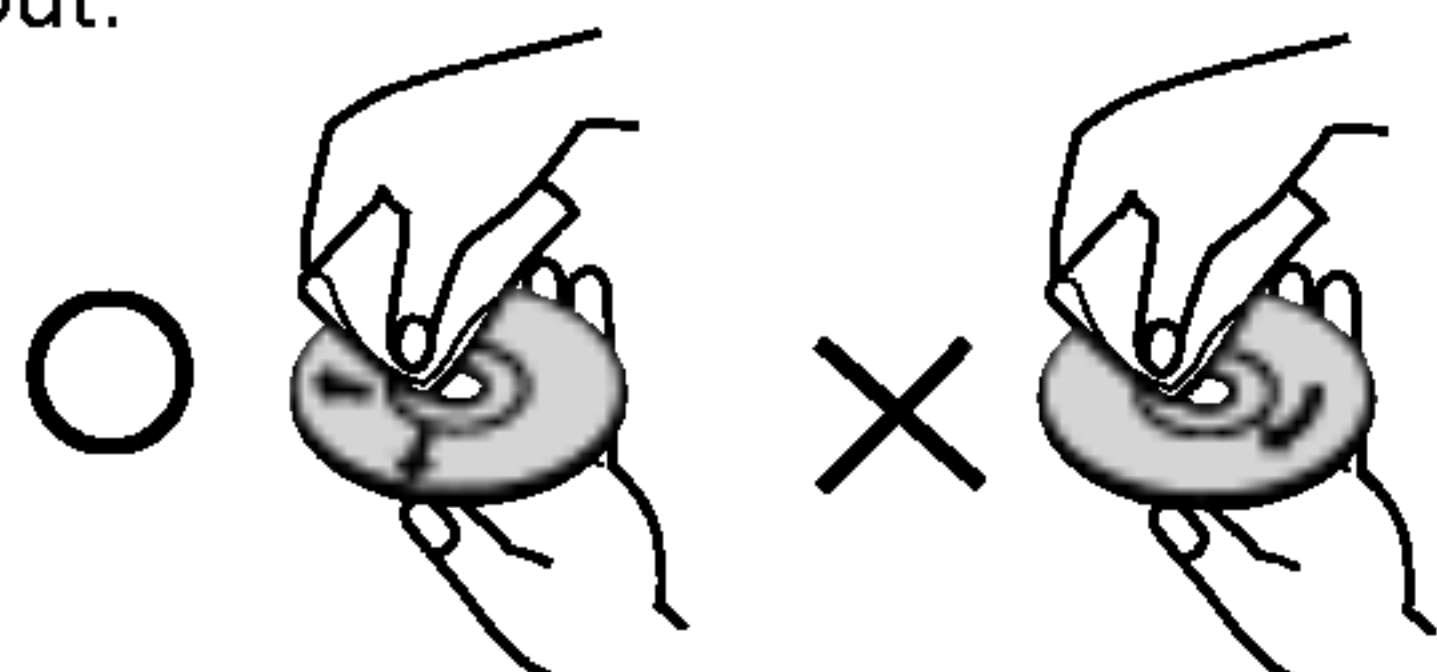

Do not use strong solvents such as alcohol, benzene, thinner, commercially available cleaners, or anti-static spray intended for analog records.

Notes on Remote Control

Remote Control Operation Range

Point the remote control at the remote sensor and press the buttons.

- **Distance:** About 23 ft (7 m) from the front of the remote sensor.
- **Angle:** About 30° in each direction of the front of the remote sensor.

Remote control battery installation

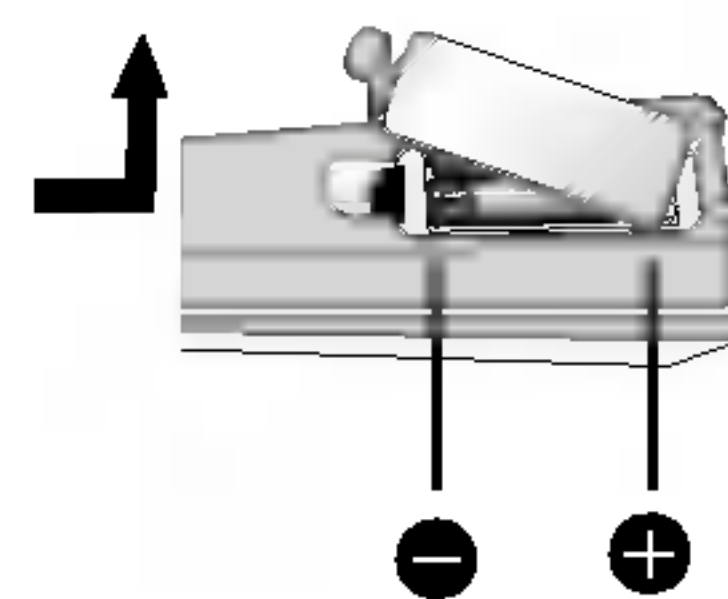

Detach the battery cover on the rear of the remote control, and insert two R03 (size AAA) batteries with \oplus and \ominus aligned correctly.

⚠ Caution

Do not mix old and new batteries. Never mix different types of batteries (standard, alkaline, etc.).

Notes on Tapes

Preventing record

Removing the tab(s) of the cassette (with a small screwdriver) will prevent accidental erasure.

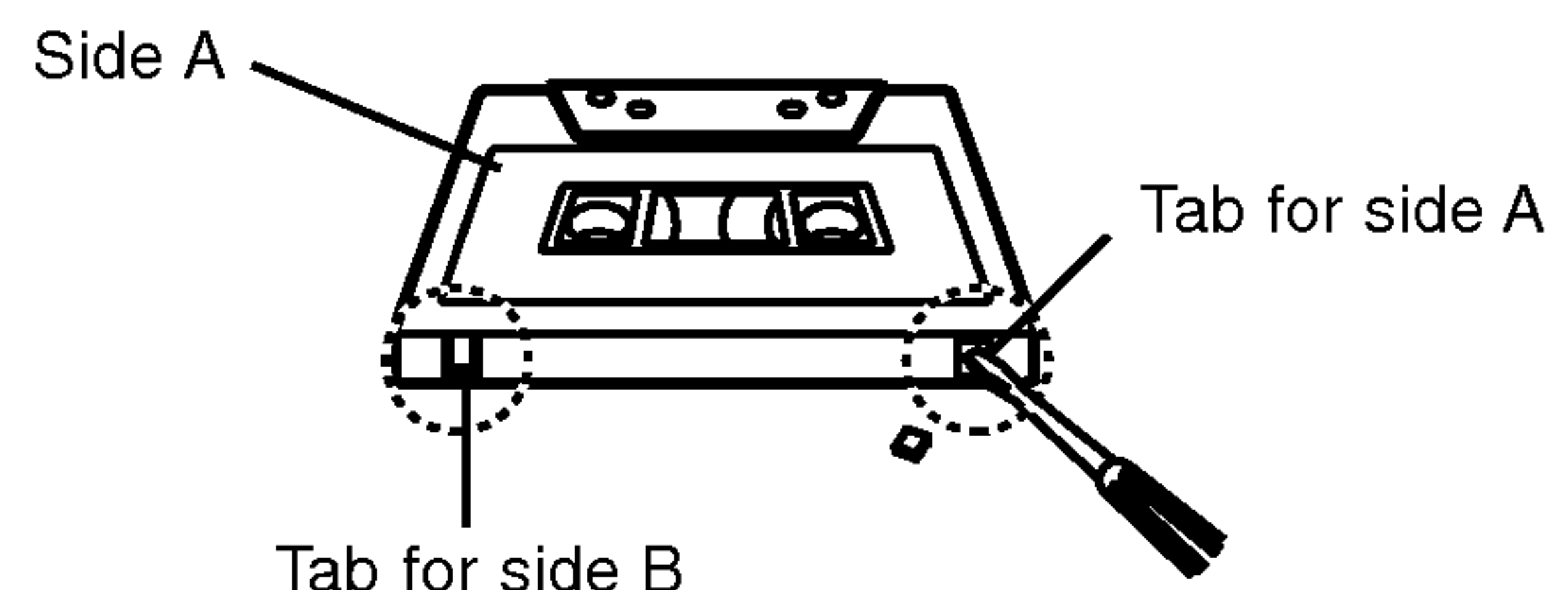

To record again, cover the hole of the tab with adhesive tape.

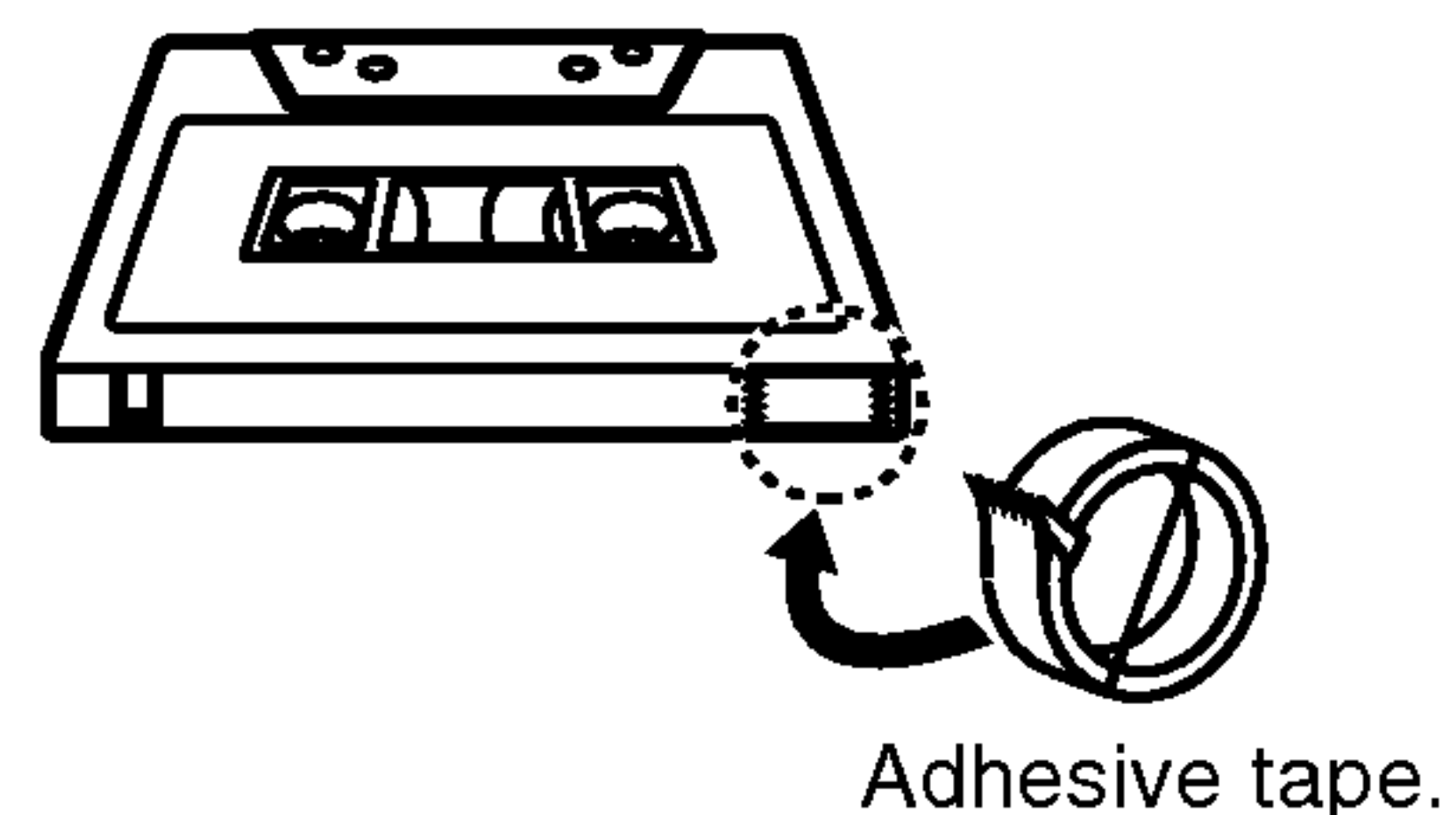

Front Panel/Rear Panel

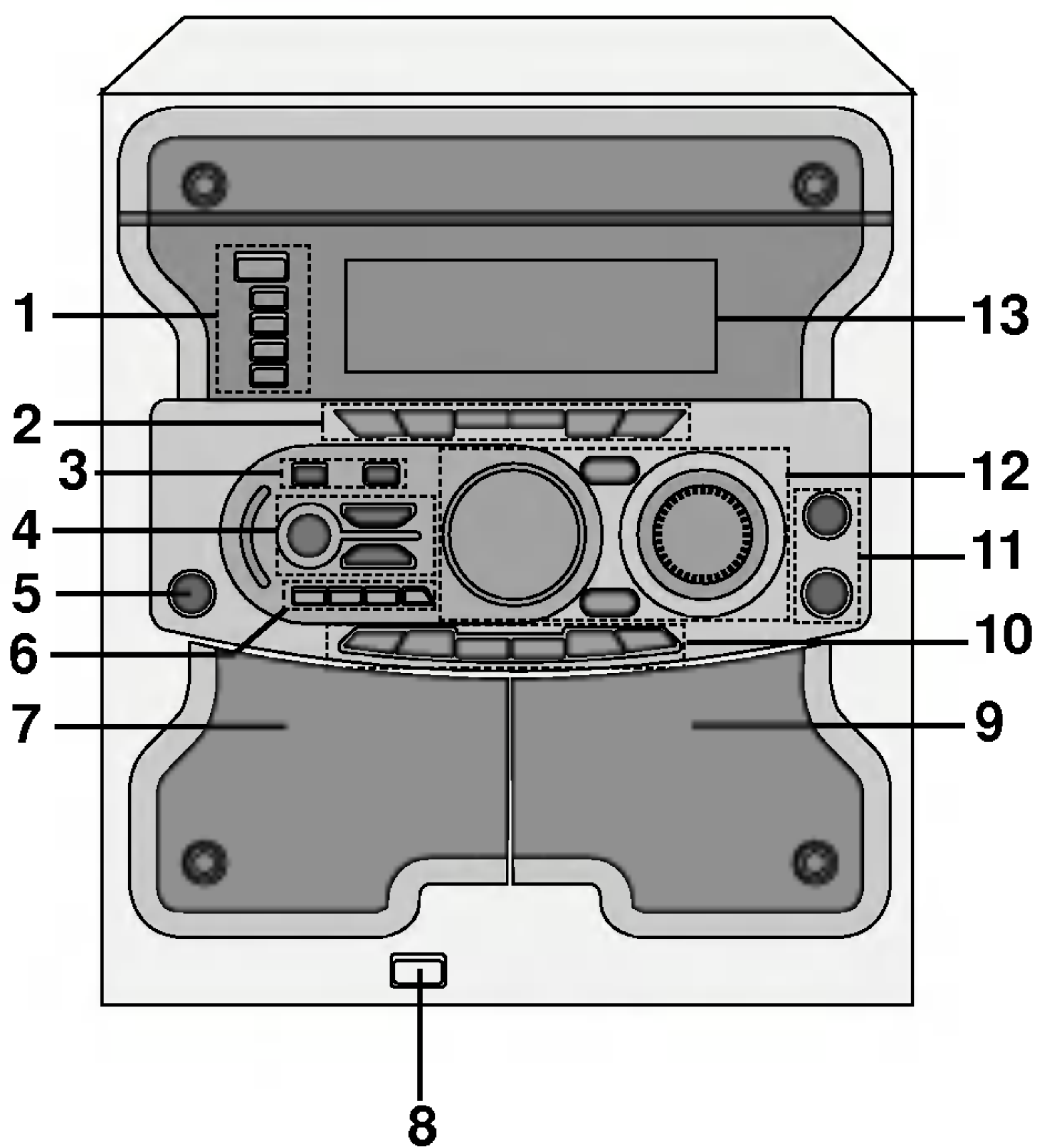

1.
 - POWER (⏻ STANDBY/ON) button
 - DISC SKIP button
 - DISC DIRECT PLAY buttons (DISC 1, DISC 2, DISC 3)
2.
 - PLAY MODE button : OPTIONAL
 - DEMO button (LM-U1350/1050) (Press **DEMO** in power off state to demonstrate the function in the display window. To cancel it, press **POWER** or **DEMO** again.)
 - PROG./MEMO./ENTER button
 - MODE/RIF/HI-DUBB. button
 - MP3 OPTIMIZER button
 - CD SYNC./NOR-DUBB. button
 - TIMER button
 - CLOCK button
3.
 - CD OPEN (▲ OPEN) button
 - XTS-Pro button
4.
 - XDSS button
 - SURROUND (SURR.) button
 - OAO button
5. HEADPHONE SOCKET (PHONES) - ϕ 6.3mm
6.
 - TUNER button
 - TAPE button
 - CD button
 - AUX button (LM-W550)
 - USB button
7. ▲ PUSH EJECT position-TAPE 1 (DECK 1)
8. USB port (LM-U1350/1050/550)

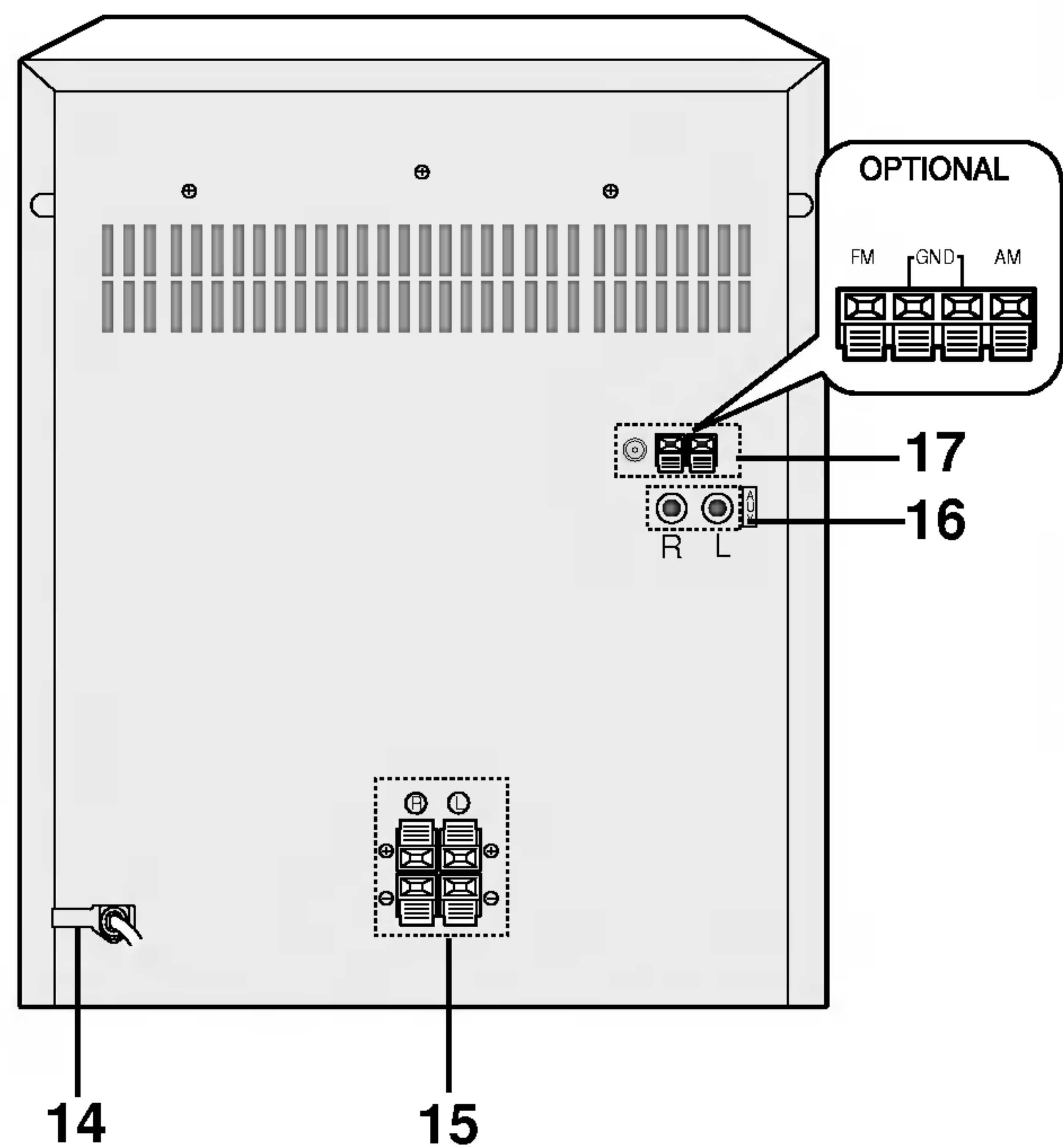

9. ▲ PUSH EJECT position-TAPE 2 (DECK 2)
10.
 - ■ STOP/CLEAR button
 - RECORD/ RECORD PAUSE (●REC/||) button
 - PRESET UP/DOWN buttons
 - PLAY (▶) button
 - REVERSE PLAY (◀) button : OPTIONAL
 - TUNING buttons
 - CD SKIP/SEARCH (◀◀◀/▶▶▶) buttons
 - TAPE REWIND/FAST FORWARD (◀◀◀/▶▶▶) buttons
11.
 - MIC VOLUME KNOB (MIC VOL.) : OPTIONAL
 - MIC JACK (MIC) - ϕ 6.3mm : OPTIONAL
12.
 - VOLUME CONTROL KNOB
 - EQUALIZER (EQ) button
 - SET/CD PAUSE (CD||) button
 - AM-NOISE button
 - RDS button : OPTIONAL
 - MULTI JOG.
13. DISPLAY WINDOW
14. POWER CORD
15. SPEAKER TERMINAL
16. AUXILIARY INPUT JACKS
17. ANTENNA TERMINAL

Remote Control

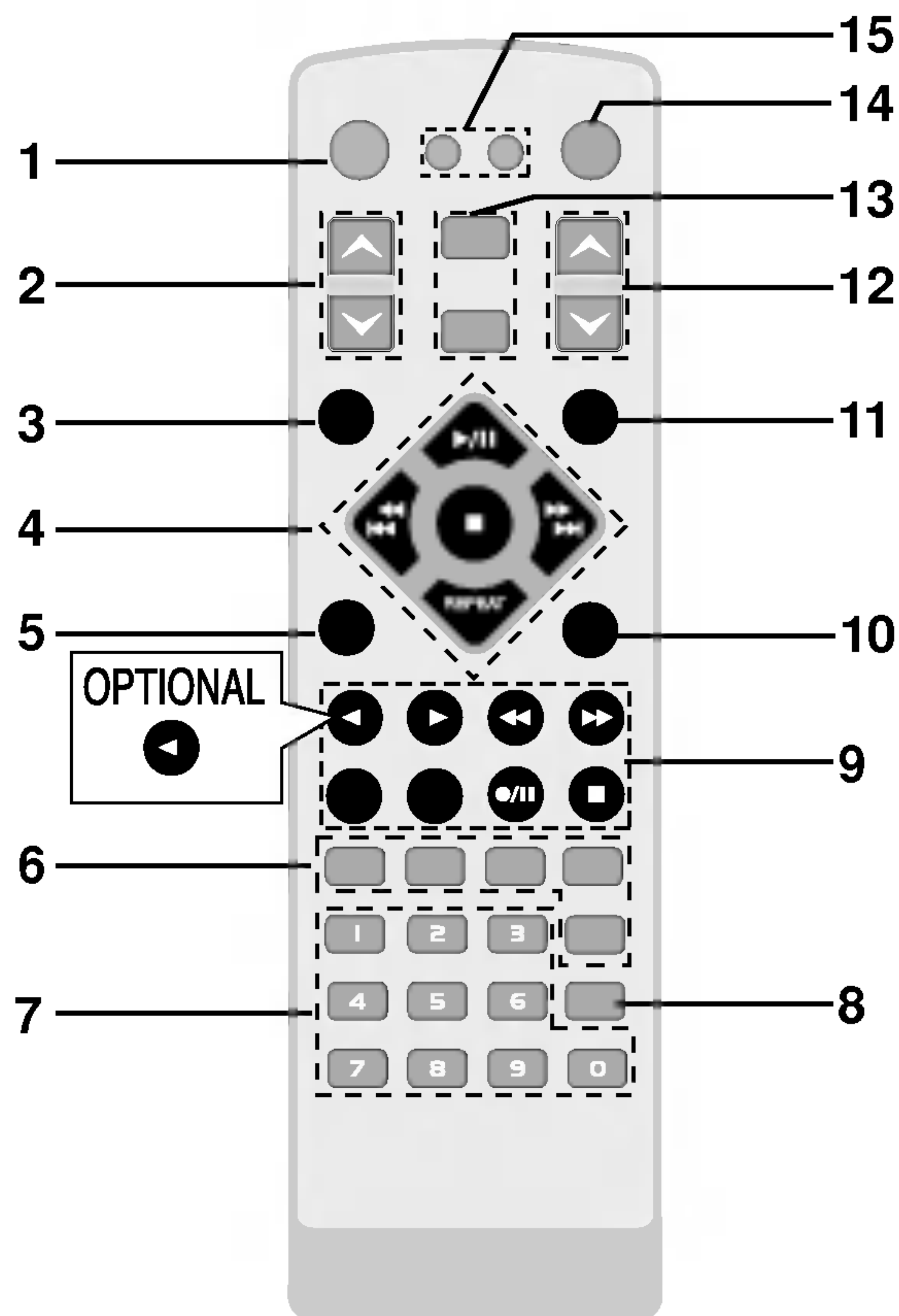

1. POWER button
2. PRESET (V/A) buttons
3. CLOCK button
4. CD FUNCTION buttons
 - PLAY/ PAUSE (▶/||) button
 - CD STOP(■) button
 - CD SKIP/SEARCH (◀◀◀/▶▶▶) buttons
 - TUNING UP/DOWN (◀◀◀/▶▶▶) buttons
 - REPEAT button
5. DISC SKIP (D.SKIP) button
6. EQUALIZER PATTERN
 - (EQ PATT.) button
 - XDSS button
 - SURROUND (SURR.) button
 - OAO button
 - XTS Pro button
7. NUMBER buttons
8. MP3 file information display (INFO) button
9. TAPE FUNCTION buttons
 - RECORD/ RECORD PAUSE (●/||) button
 - FORWARD PLAY (▶) button
 - REVERSE PLAY (◀) button : OPTIONAL
 - TAPE STOP (■) button
 - FAST FORWARD (▶▶) button
 - REWIND (◀◀) button
 - TAPE-1/2 SELECT buttons
10. PROGRAM/MEMO button
11. SLEEP button
12. VOLUME CONTROL (V/A) button
13. • USB button (LM-U1350/1050/550)
 - FUNCTION button
14. MUTE button
15. • DISP.MODE button (LM-U1350/1050)
 - DIMMER button

Connections

Speaker System Connection

Connect the speaker cords to the speaker terminals.

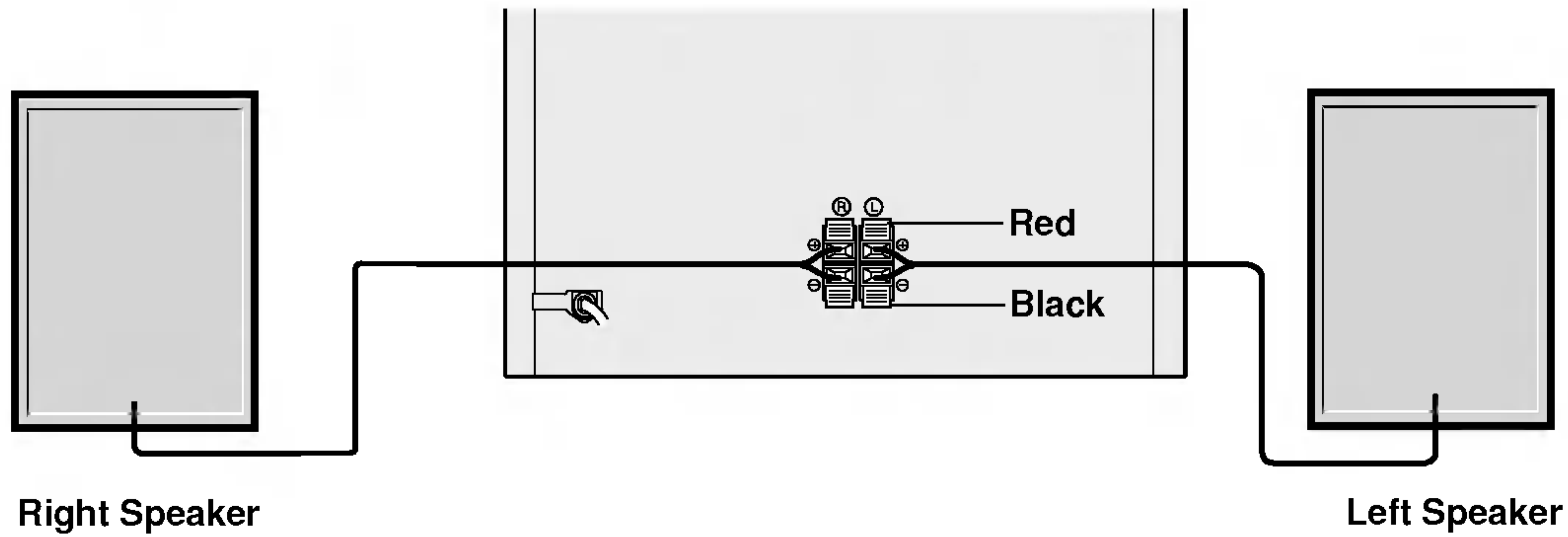

Notes

- Be sure to match the speaker cord to the appropriate terminal on the components: + to + and – to –. If the cords are reversed, the sound will be distorted and will lack base.
- If you use front speakers with low maximum input rating, adjust the volume carefully to avoid excessive output on the speakers.
- Do not disassemble the front cover of supplied speaker.
- Be sure to connect the speaker cord with power off.

Antenna (Aerial) Connections

Connect the supplied FM/AM antennas for listening to the radio.

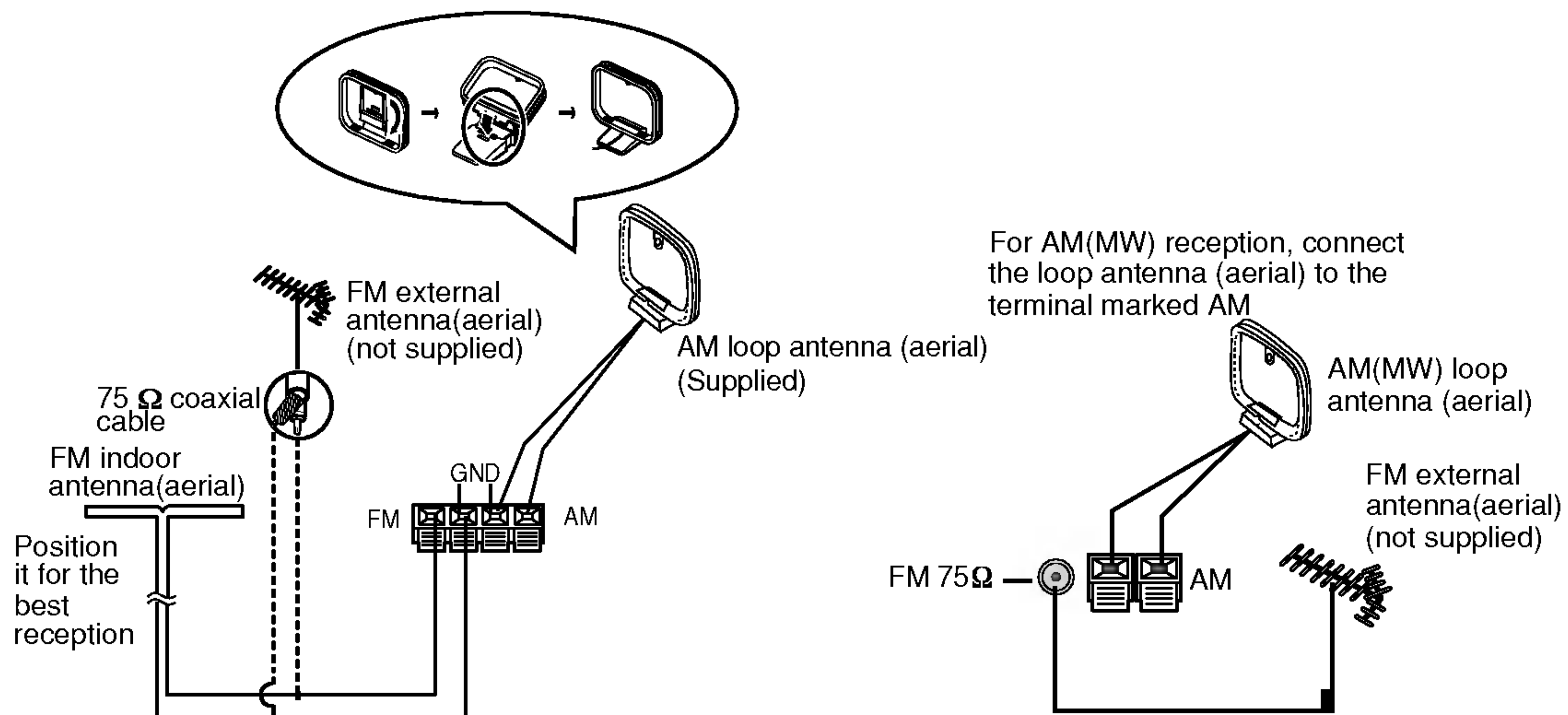

Notes

- To prevent noise pickup, keep the AM loop antenna away from the unit and other components.
- Be sure to fully extend the FM wire antenna.
- After connecting the FM wire antenna, keep it as horizontal as possible.

Audio Adjustment

Setting the voltage (OPTIONAL)

If your set is equipped with a voltage selector at the back side, be sure to set it to your local power supplied before connecting the AC power cord.

Setting the CLOCK

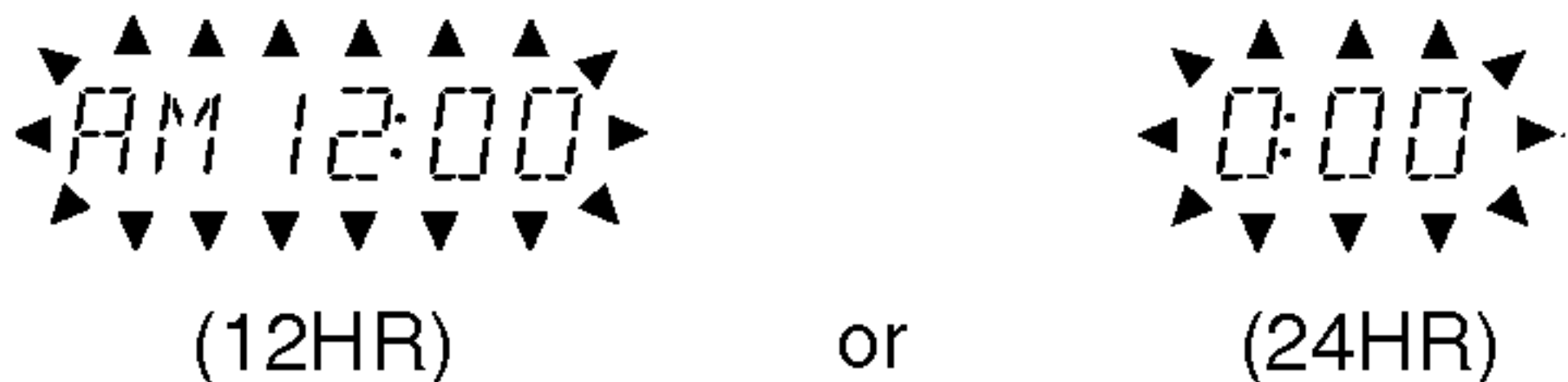
- 1** Press **CLOCK**.
(If the clock requires setting, press and hold **CLOCK** for more than 2 seconds.)
- The hours begin to blink.
- 2** Select a 24 hour cycle or 12 hour cycle by turning **MULTI JOG**..

(12HR) or (24HR)
- 3** Press **SET** to confirm the selected hour cycle.
- 4** Use **MULTI JOG**. to set the correct hours.
- 5** Press **SET**.
- 6** Use **MULTI JOG**. to set the correct minutes.
- 7** Press **SET** and the correct time is shown on the display.
- 8** Press **CLOCK** at any time briefly to see the time.

Volume Adjustment

- Turn **VOLUME CONTROL KNOB** clockwise to increase the sound level, or counterclockwise to decrease it.
- Press **VOLUME (▲)** to increase the sound level, or press the **VOLUME (▼)** to decrease it on the remote control.
- **Headphone Socket**
Connect a stereo headphone plug (∅ 6.3mm) into the headphone jack.
The speakers are automatically disconnected when you plug in the headphones (not supplied).

Sound Quality Adjustment

- **To activate stereo sound**
Select a desired sound mode by using **EQ PATT.** button on the remote control or **EQ** button on the front panel.
Each time you press the button the indication changes as follows.

FLAT → POP → CLASSIC → ROCK
↓
MUSICAL ← SALSA ← JAZZ ← DRAMA
↓
SAMBA → USER MODE → FLAT

- 1** When you select **USER MODE**, press the **ENTER** button repeatedly.
You can select Three of sound mode.
(BASS, MIDDLE, TREBLE)
- 2** Adjust the level by turning **MULTI JOG**.
- 3** Press **ENTER**.

Sleep Function

When the sleep timer is used, the power is automatically turned off after the specified time has elapsed.

- 1** To specify the time delay before the power is turned off, press **SLEEP**.
In the display window you can see *SLEEP 90* for about 5 seconds. This means that the system turns off automatically after 90 minutes.
Each time the button is pressed the time interval before it turns off is reduced by 10 minutes. i.e. 80...70... etc. Select the desired time to turn off.
- 2** To check the remaining time until the power is turned off.
While the sleep function is active press **SLEEP** briefly. The time remaining until it turns off is displayed for about 5 seconds.

Note

If you press **SLEEP** while the sleep time is displayed, the **SLEEP** time is reset.

To cancel the sleep timer mode

If you wish to stop the function, press the **SLEEP** button repeatedly until **SLEEP 10** appears, and then press **SLEEP** once again while **SLEEP 10** is displayed.

Audio Adjustment

MUTE

Press **MUTE** to mute your unit.

You can mute your unit in order, for example, to answer the telephone, "MUTE" indicator blinks in the display window.

SURROUND

To activate surround mode

- Select a desired surround mode by using the **SURROUND (SURR.)** button on the front panel or on the remote control.
- Each you press the button the indication changes as follows.

SURROUND OFF → CINEMA → EALA
↓
VOCAL ← THEATER ← HALL ← TUNNEL
↓
CHURCH → DISCO → SURROUND OFF

XDSS (Extreme Dynamic Sound System)

- Press **XDSS** to reinforce treble, bass and surround effect.
- Each you press the button the indication changes as follows.

XDSS OFF → XDSS ON

DISPLAY MODE (LM-U1350/1050)

Whenever you press **DISPLAY MODE (DISP. MODE)**, you can enjoy the spectrum change with 6 types in the display window.

DIMMER

This function is darken the display window by half in power-on status. Press **DIMMER** once, and the display is darken, and if you press it once more, the display will darken by half too. To cancel it press the button again.

DEMO (LM-U1350/1050)

Press **DEMO** in power off state to demonstrate the function in the display.

to cancel it, press **POWER** or **DEMO** again.

During demonstration in power-on status you can cancel it by using the other buttons.

OAO (Orientation Acoustic Optimizer)

Press OAO to reinforce the bass sound. The "OAO" indicator lights and "OAO ON" passes by with the left side from the right. To cancel, press OAO again than "OAO OFF" passes by with the left side from the right.

XTS Pro

The unique sound quality of the LG Technology creates the optimum sound for you to play the perfect playback of the original sound and to feel the living sound source.

Each time you press XTS Pro the setting changes in the following order.

XTS-P ON → XTS-P OFF



ote

The XTS pro function will not be operated when an earphone has connected.

MP3 Optimizer

This function is optimized for compressible MP3 file. Improve the bass sound to make sweet sound.

Each time you press MP3 OPTIMZER the setting changes in the following order.

MP3 OPT ON → MP3 OPT OFF

Audio Adjustment

Timer Function

The unit can set the clock function in power on/off state. With the TIMER function you can have the radio reception and recording, CD play, tape play, USB Device play or turned on and off at the time desired.

1 Press **CLOCK** to check the current time.

For your reference

If you don't set clock, timer function doesn't work.

2 Press **TIMER** to enter the timer setting mode. TUNER-CD-TAPE-USB(LM-U1350/1050/550) flashes in the display window in turn.

For your reference

If you want to correct the previous memorized TIMER setting, press and hold the TIMER button more than 2 seconds.

- The previous memorized timer on time and TIMER indicators appear in the display.

3 Press **SET** when the desired function is blinking.

4 1. a. When you select the TUNER function, 'PLAY' and 'REC' indicator blink in the display window alternately for about 3 seconds.
'PLAY' indicator : TUNER play only
'REC' indicator : TUNER play and recording
b. Select the previous memorized preset number with **MULTI JOG**. and press **SET**.
- 'ON TIME' indicator appears for about 0.5 seconds in the display window and then disappears.
2. When you select the CD or TAPE function,
- 'ON TIME' indicator appears for about 0.5 seconds in the display window and then disappears.

5 Set the hour to switch on by turning **MULTI JOG**.

6 Press **SET** to confirm the hour to switch on.

7 Set the minute to switch on by turning **MULTI JOG**.

8 Press **SET** to confirm the minute to switch on. 'OFF TIME' indicator appears for about 0.5 seconds in the display window and then disappears.

9 Set the hour to switch off by turning **MULTI JOG**.

10 Press **SET** to confirm the hour to switch off.

11 Set the minute to switch off by turning **MULTI JOG**.

12 Press **SET**.

13 Adjust the volume level by turning **MULTI JOG**.

14 Press **SET**.

"⌚" appears in the display window and the timer setting has been completed.

15 Switch the system off.
The selected function is automatically switched on and off at the time set.

To cancel or check the timer

Each time the TIMER button is pressed you can select the timer set or cancel. You can also check the timer setting status.

To activate or check the timer, press the **TIMER**

button so that "⌚" appears in the display window.

To cancel the TIMER, press the **TIMER** button so that

"⌚" disappears in the display window.

Auxiliary Function

1 Connect an auxiliary device i.e. TV or VCR to the rear mounted AUX phone sockets.

2 Press **FUNCTION** on the remote control. Each time you press the button the indication changes as follows.
FM → AM → CD → AUX

Note

You can also record from the auxiliary input source, see Recording Section.

RDS Function - OPTIONAL

About RDS

This unit is equipped with RDS (Radio Data System), which brings a wide range of information from FM radio. RDS is a system for transmitting station call signs or network information, a description of station programme type text message about the station or specifics of musical selection and the correct time.

RDS Tuning

When a FM station containing RDS data is tuned in, the unit will automatically display the station's call sign and the RDS indicator will light in the Display Window as well as indicators for the programme type recognition (PTY), Radio Text (RT), Clock Time (CT) and RDS services programme (PS) if transmitted by the station.

RDS Display Options

The RDS system is capable of transmitting a wide variety of information in addition to the initial call sign that appears when a station is first tuned. In normal RDS operation the display will indicate the station name, broadcast network or call letters. Pressing **RDS** on the front panel enables you to cycle through the various data types in the sequence:

(FREQUENCY → PTY → RT → CT → PS)

- **PTY (Programme type recognition)**- The programme type is shown on the display window.
- **RT (Radio text recognition)**- The radio station's name is displayed on the display window.
- **CT (Time controlled by the channel)**- Enable the unit to receive the actual time and show it on the display window.
- **PS (Programme Service name)**- The programme title is displayed on the display window.

Notes





- Some RDS stations may not choose to include some of these additional features. If the data required for the selected mode is not being transmitted, the Display Window will show a **PTY NONE, RT NONE, CT NONE, PS NONE** message.

Programme Search (PTY)

A major benefit of RDS is its ability to encode broadcasts with Programme Type (PTY) codes that indicate the type of material being broadcast. The following list shows the abbreviations used to indicate each PTY along with an explanation of the PTY.



NEWS	News
AFFAIRS	Current Affairs
INFO	Information
SPORT	Sports
EDUCATE	Educational
DRAMA	Drama
CULTURE	Culture
SCIENCE	Science
VARIED	Varied Speech Programme
POP M	Popular Music
ROCK M	Rock Music
EASY M	Easy Listening Music
LIGHT M	Classical Music
CLASSICS	Serious Classical Music
OTHER M	Other Music
WEATHER	Weather Information
FINANCE	Financial Programmes
CHILDREN	Children's Programmes
SOCIAL	Social Affairs Programmes
RELIGION	Religious Broadcasts
PHONE IN	Phone-In Programmes
TRAVEL	Travel and Touring
LEISURE	Leisure and Hobby
JAZZ	Jazz Music
COUNTRY	Country Music
NATION M	National Music
OLDIES	Oldies Music
FOLK M	Folk Music
DOCUMENT	Documentary Programmes
TEST	Station Alarm Test Message
ALARM 1	Emergency Broadcast Information

You may search for a specific Programme Type (PTY) by following these steps:





- 1 Press TUNER (or FUNCTION) to select FM mode.**
- 2 Select a desired station by pressing   buttons.**
When the RDS transmission is received, the display shows the program service name (PS) after RDS indicator appears.
- 3 Press the RDS to select PTY mode.**
- 4 To search for a different PTY, press the PRESET UP/DOWN buttons while the last PTY in use is still displayed to scroll through the list of available PTY types.**
- 5 When the PTY is selected, press the   within 5 seconds.**
The unit will go into an automatic search mode and attempt to find the next station with acceptable signal strength that matches the desired PTY type.

Presetting the radio stations

You can preset 50 stations for FM and AM. Before tuning, make sure that you have turned down the volume to the minimum.

- 1 Press TUNER (or FUNCTION) to select the frequency (AM or FM) you want.**
Every time you press this button, AM and FM changes alternately.
- 2 Press   buttons on the front panel until the frequency indication starts to change.**

Notes

- **Automatic Tuning**
Press the   buttons.
- Scanning stops when the unit tunes in a station.
- **Manual Tuning**
Use the MULTI JOG.
- 3 Press PROG./MEMO. on the front panel .**
A preset number will flash in the display window.
- 4 Press PRESET+/- buttons (or PRESET ( / ) on the remote control) to select the preset number you want.**

5 Press PROG./MEMO. on the front panel.
The station is stored.

6 Repeat steps 2 to 5 to store other stations.



To clear all the memorized stations

Press and hold **PROG./MEMO.** on the front panel for about two seconds, "CLEAR" appears on the display window and then press **CLEAR**, the stations are cleared.





For your reference

If all stations have already been entered, FULL message will appear in the display window for a moment and then a preset number will blink. To change the preset number, follow the steps 4-5.

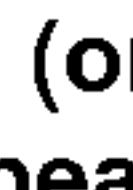

To recall presets

Press and hold **PRESET buttons** (or **PRESET ( / )** on the remote control) until the desired preset number appears or press it repeatedly.

Listening to the radio

- 1 Press   (or FUNCTION) to select the frequency (AM or FM) you want.**
Every time you press this button, AM and FM changes alternately.
The last received station is tuned in.
- 2 Press PRESET+/- buttons (or PRESET ( / ) on the remote control) repeatedly to select the preset station you want.**
- Each time you press the button, the unit tunes in one preset station at a time.
- 3 Adjust the volume by rotating VOLUME CONTROL KNOB (or pressing VOLUME ( / ) on the remote control) repeatedly.**

To listen to non-preset radio stations

- Use manual or automatic tuning in step 2.
- For automatic tuning, press and hold   buttons on the front panel.

To turn off the radio

Press **POWER** to turn the unit off or select another function mode (CD, TAPE or AUX).

For your reference

- **If an FM program is noisy**
Press **MODE/RIF** so that "STEREO" disappears on the display window. There will be no stereo effect, but the reception will be improved. Press **MODE/RIF** again to restore the stereo effect.
- **To improve reception**
Repose the supplied antennas.

Notes

- Use **MODE/RIF** (Radio Interference Filter) function to switch to mono reception if stereo reception is distorted by noise.
- When recording the MW(AM) broadcast, beat noises may occur. If it does, press **MODE/RIF** once.
- When listening the MW(AM) broadcast, beat noises may occur. If it does, press **AM-NOISE** once. Each time you press **AM-NOISE** the setting changes in the following order.
AM NOISE ON → AM NOISE OFF

Tape Playback

Basic Playback

- 1 Press TAPE 1/2 to select TAPE 1 or TAPE 2.
(“NO TAPE” appears in the display window.)
- 2 Open cassette TAPE 1 (or 2) by pushing PUSH EJECT position.
- 3 Insert one or two cassette with the tape side to the bottom and then close the TAPE 1 (or 2).
- 4 Press PLAY () or (OPTIONAL).

AUTO STOP DECK (TAPE 1/2)

After auto stop deck plays only front side, the unit stops automatically.

AUTO REVERSE DECK (TAPE 2):OPTIONAL

You can select direction of the cassette you want by pressing PLAY MODE.

Pressing	Display	Function
Once	OR	After the cassette plays front or reverse(backward play) side, stops automatically.
Twice	OR	After the cassette plays front and reverse side, stops automatically.
Three times	OR	After the cassette plays six times repeatedly front and reverse side, stops automatically.

To Stop Play

Press STOP() / CLEAR on the front panel or TAPE STOP() on the remote control during playback.

To Play Rewind or Fast Forward

After pressing on the front panel or on the remote control during playback, press PLAY () at the point you want.

Dubbing

This function shows how to record from tape to tape.

- 1 Press TAPE 1/ 2.
 - Cassette TAPE 1- Insert a playback tape to dub.
 - Cassette TAPE 2- Insert a blank tape.

- 2 Press NOR-/ HI-DUBB. as follow.

Pressing	Display	Function
NOR-DUBB.	DUBB. (LM-U1350/1050)	Normal speed dubbing
	NOR DUBB (LM-W550/U550)	
HI-DUBB.	HI-SP. DUBB. (LM-U1350/1050)	Double speed dubbing
	HI DUBB (LM-W550/U550)	

To stop recording, press STOP().

Note

- The USB device or USB ports may be damaged if opening the tape-door when the USB device is connected.

Recording

Wind the tape to the point recording starts. Use only normal tapes. You can record from cassette deck 2 only.

Basic Setting

- 1 Press CD or TUNER (or TUNER/BAND), USB.
- 2 Open the cassette TAPE 2 and insert a blank cassette into the cassette compartment.
Set the recording direction : OPTIONAL
Press PLAY MODE repeatedly to set the recording direction.

Recording from Radio, CD, USB or Auxiliary source

- 1 Press REC/ on the front panel.
“REC” blinks and holds the cassette in pause mode.
- 2 Press PLAY() on the front panel.
The recording begins.

To Pause recording

To pause the recording, press REC/ on front panel or on the remote control again.
“REC” blinks on the display window.

To Stop recording

Press TAPE STOP().

CD to Tape Synchronized Recording

The CD synchro recording function dubs a complete CD and programmed titles automatically into a cassette.

- 1 Press CD SYNC. in stop mode.
“REC” blinks and CD SYNC. is lit on the display window.
- 2 The synchronized recording is started automatically after about 7 seconds.

Note

- If you wish to record the desired track, select the desired track with before commencing CD synchro recording.

CD Playback

Basic Playback

- 1 Press **⏻** STANDBY/ON to turn on the unit.
- 2 Press the CD button on the front panel to enter the CD mode.
If no disc is entered in the disc tray, the "NO DISC" is displayed.
- 3 Press CD OPEN (**▲** OPEN) and place the disc into the disc tray.
The disc on the left (DISC 1) is played first.

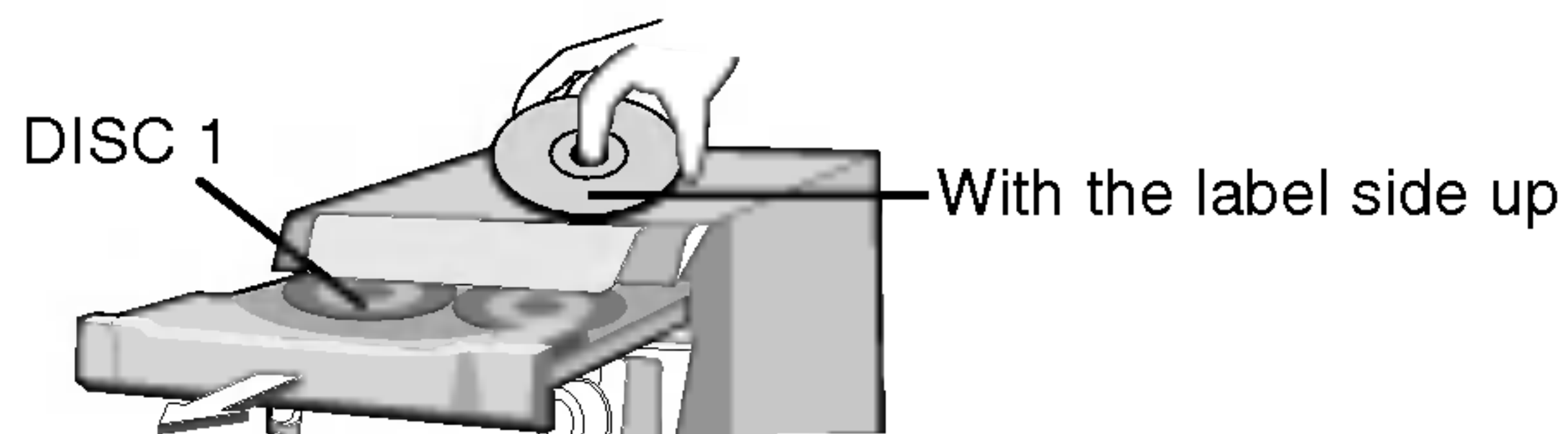

Note

To load an 8cm(3 inch) disc, put it onto the inner circle of the tray.

- 4 Press CD OPEN (**▲** OPEN) to close the disc compartment.
Audio CD: "READING" appears in the display window, and then the total number of tracks and the playing time are displayed.
MP3 CD: "READING" appears in the display window, and then the total number of files is displayed.
- 5 Press PLAY(**▶**) on the front panel or CD PLAY/PAUSE (**▶/||**) on the remote control.
In addition, you can also play an Audio CD or MP3 CD using the NUMBER buttons.

To Pause Play

Press CD PAUSE (CD**||**) on the front panel or CD PLAY/PAUSE (**▶/||**) on the remote control during playback. Press this button again it to resume play.

To Stop Play

Press STOP(**■**)/CLEAR on the front panel or CD STOP(**■**) on the remote control during playback.

To Skip a Track

- Press **▶▶▶▶** button to go to the next track.
- When **◀◀◀◀** button is pressed once midway through a track, the player returns to the start of that track. When it is pressed again, a track is skipped each time the button is pressed.

To Search a Track

After pressing and holding **◀◀◀◀/▶▶▶▶** button on the remote control during playback, then release at the point you want.

Note

- This function is not available to play a MP3 file.

To Go to the next discs

Press DISC SKIP on the front panel or D.SKIP on the remote control during playing or stopping.

To Select a disc directly

Press DISC 1, DISC 2 or DISC 3 during playing or stopping.

When you press DISC 1-3 before playing a disc, the unit will automatically start playing the selected disc.

To Replace discs during Playback

You can open the disc tray during playing a disc to check what discs are to be played next and replace discs without interrupting playback of the current disc.

- 1 Press the CD OPEN (**▲** OPEN)
The disc tray is opened. Two disc compartments appear. Even if the unit is playing a disc, it doesn't stop playing.
- 2 Replace discs in the compartments with new ones.
The unit plays the disc in the left compartment after the current disc, and then the one in the right compartment.
- 3 Press CD OPEN (**▲** OPEN).
The CD door is closed.

Note

- Do not place more than one compact disc on one disc tray at the same time.
- Do not push the disc tray to close CD door, as you may damage the unit.

To check MP3 file information

Press the INFO button during MP3 file playback.

- The information (Title, Artist or Album) of the MP3 file will be shown in the display window.
- If there is no the information of the MP3 file, "NO ID3 TAG" indicator will be shown in the display window.

Note

- This unit can play a CD-R or CD-RW that contains audio titles or MP3 files.
- The MP3 file name and ID3 TAG should be named using English.

CD Playback

To Repeat Play

To play one track repeatedly

Press **REPEAT** once during playback.

- “ 1” appears on the display window.

To play one disc repeatedly

Press **REPEAT** again during playback.

- “ 1 DISC” appears on the display window.

To play all tracks on all discs repeatedly

Press **REPEAT** once more during playback.

- “ ALL DISC” appears on the display window.

To cancel repeat play

- Press **REPEAT** several times until repeat indicator disappears.

Program repeat play

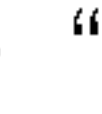
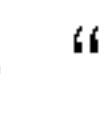
- Press **REPEAT** once during program play.
 - “ 1” appears on the display window.
(One track repeat)
- Press **REPEAT** again during program play.
 - “ ALL DISC” appears on the display window.
(All program repeat)

To Program Play

You can arrange the order of the tracks on the discs and create your own program. The program can contain up to 20 tracks.

- 1** Press **PROG./MEMO.** on the front panel or **PROGRAM/MEMO** on the remote control in the stop mode.
- 2** Press **DISC SKIP** or **DISC DIRECT PLAY (DISC1/2/3)** on the front panel or **D.SKIP** on the remote control to select the disc.
- 3** Press **CD SKIP/ SEARCH**   on the front panel or on the remote control to select the track.
- 4** Press **PROG./MEMO.** on the front panel or **PROGRAM/MEMO** on the remote control.
- 5** Repeat steps 1~4.
- 6** Press **PLAY(▶)** on the front panel or **CD PLAY/ PAUSE (▶/||)** on the remote control.

To check program contents

Press **PROG./MEMO.** (or **PROGRAM/MEMO** on the remote control) in the stop mode.

- The disc, track and program number will be displayed.

To clear program contents

Press **PROG./MEMO.** (or **PROGRAM/MEMO** on the remote control) on the stop mode. And then press **CLEAR** on the front panel or **CD STOP(■)** on the remote control.

To add program contents

1. Press **PROG./MEMO.** (or **PROGRAM/MEMO** on the remote control) repeatedly in the program stop mode until “Disc Number” blinks.
2. Repeat steps 2~4.

To modify program contents

1. Press the **PROG./MEMO.** (or **PROGRAM/MEMO** on the remote control) to display program number you want to modify.
2. Repeat steps 2~4.

Connecting USB port

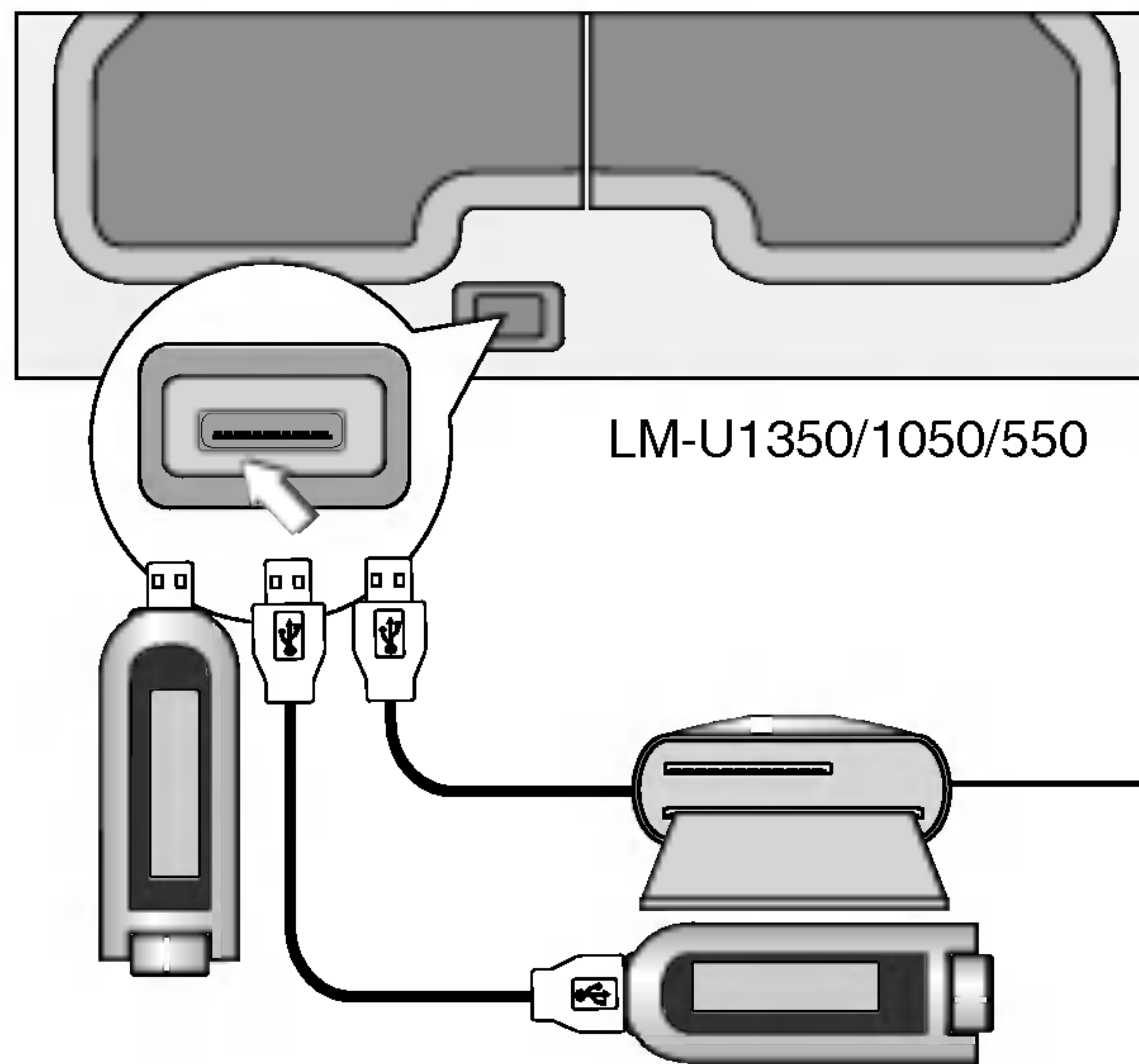

LM-U1350/1050/550

Readable Card

- SmartMedia Card(SMC)
- Compact Flash Card(CFC)
- Micro Drive(MD)
- Secure Digital Card(SD)
- Multi Media Card(MMC)
- Memory Stick(MS)
- Memory Stick Pro(MS-Pro)
- Compatible with : FAT12,16,32
- Only use the memory cards recommended

1 Plug the USB device into the USB port of your unit.

2 Press USB button on the front panel.

Notes

- Don't remove a MP3 player or memory card while playing the USB.

- Don't add or remove the memory card when playing the USB by using a multi card reader.
- Numbers of file available are maximum 999 EA.
- Be sure to save file in the memory card after formatting.
- No cladding hard disk is supported.
- The MP3 player requiring installation of a drive is not supported.
- There may be memory and card not be recognized depending on the type of memory card.

USB device Playback

Basic Playback

1 Press the USB button on the front panel to enter the USB mode.
"CHECKING" appears in the display window, and then the total number of files is displayed.

2 Press PLAY(▶) on the front panel or CD PLAY/ PAUSE (▶/||) on the remote control.
In addition, you can also play using the NUMBER buttons.

To Pause Play

Press CD PAUSE (CD||) on the front panel or CD PLAY/ PAUSE (▶/||) on the remote control during playback.

Press this button again it to resume play.

To Stop Play

Press STOP(■)/CLEAR on the front panel or CD STOP(■) on the remote control during playback.

To Go to the next cards

Press DISC SKIP on the front panel or D.SKIP on the remote control during playing or stopping.

To Skip a Track

- Press ▶▶▶▶ button to go to the next track.
- When ◀◀◀◀ button is pressed once midway through a track, the player returns to the start of that track. When it is pressed again, a track is skipped each time the button is pressed.

To check MP3 file information

Press the INFO button during MP3 file playback.

- The information (Title, Artist or Album) of the MP3 file will be shown in the display window.
- If there is no the information of the MP3 file, "NO ID3 TAG" indicator will be shown in the display window.

Notes

- This unit can play USB device that contains MP3/WMA files.
- The MP3 file name and ID3 TAG should be named using English.
- This player can not format memory card.
- This player can not use USB HUB.

USB device Playback

To Repeat Play

To play one track repeatedly

Press **REPEAT** once during playback.

- “ 1” appears on the display window.

To play one disc repeatedly

Press **REPEAT** again during playback.

- “ 1 DISC” appears on the display window.

To play all tracks on all discs repeatedly

Press **REPEAT** once more during playback.

- “ ALL DISC” appears on the display window.

To cancel repeat play



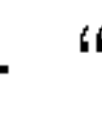
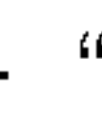

- Press **REPEAT** several times until repeat indicator disappears.

Program repeat play

- Press **REPEAT** once during program play.
 - “ 1” appears on the display window.
(One track repeat)
- Press **REPEAT** again during program play.
 - “ ALL DISC” appears on the display window.(All program repeat)

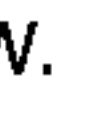
To Program Play

You can arrange the order of the tracks on the discs and create your own program. The program can contain up to 20 tracks.

- 1** Press **PROG./MEMO.** on the front panel or **PROGRAM/MEMO** on the remote control in the stop mode.
- 2** Press **DISC SKIP** front panel or **D.SKIP** on the remote control to select the disc.
- 3** Press **CD SKIP/ SEARCH**     on the front panel or on the remote control to select the track.
- 4** Press **PROG./MEMO.** on the front panel or **PROGRAM/MEMO** on the remote control.
- 5** Repeat steps 1~4.
- 6** Press **PLAY(▶)** on the front panel or **CD PLAY/ PAUSE (▶/||)** on the remote control.

To check program contents

Press **PROG./MEMO.** (or **PROGRAM/MEMO** on the remote control) in the stop mode.

- The disc, track and program number will be displayed.

To clear program contents

Press **PROG./MEMO.** (or **PROGRAM/MEMO** on the remote control) on the stop mode. And then press **CLEAR** on the front panel or **CD STOP(■)** on the remote control.

To add program contents

1. Press **PROG./MEMO.** (or **PROGRAM/MEMO** on the remote control) repeatedly in the program stop mode until “Track Number” blinks.
2. Repeat steps 2~4.

To modify program contents

1. Press the **PROG./MEMO.** (or **PROGRAM/MEMO** on the remote control) to display program number you want to modify.
2. Repeat steps 2~4.

Troubleshooting

Check the following guide for the possible cause of a problem before contacting service.

Symptom	Cause	Correction
No power.	<ul style="list-style-type: none"> The power cord is disconnected. 	<ul style="list-style-type: none"> Plug the power cord into the wall outlet securely.
No sound.	<ul style="list-style-type: none"> The audio cables are not connected securely. 	<ul style="list-style-type: none"> Connect the audio cable into the jacks securely.
	<ul style="list-style-type: none"> The power of the external source equipment is switched off. 	<ul style="list-style-type: none"> Turn on the equipment connected with the audio cable.
	<ul style="list-style-type: none"> The speaker cable is set to the wrong position. 	<ul style="list-style-type: none"> Set the speaker cable to the correct position, then turn on the unit again by pressing POWER.
The unit does not start playback.	<ul style="list-style-type: none"> No disc or tape is inserted. 	<ul style="list-style-type: none"> Insert a disc or tape.
	<ul style="list-style-type: none"> An unplayable disc or tape is inserted. 	<ul style="list-style-type: none"> Insert a playable disc or tape.
	<ul style="list-style-type: none"> The disc is placed upside down. 	<ul style="list-style-type: none"> Place the disc with the playback side down.
	<ul style="list-style-type: none"> The disc is not placed within the guide. 	<ul style="list-style-type: none"> Place the disc on the disc tray correctly inside the guide.
	<ul style="list-style-type: none"> The disc is dirty. 	<ul style="list-style-type: none"> Clean the disc.
The remote control does not work properly.	<ul style="list-style-type: none"> The remote control is not pointed at the remote sensor of the unit. 	<ul style="list-style-type: none"> Point the remote control at the remote sensor of the unit.
	<ul style="list-style-type: none"> The remote control is too far from the unit. 	<ul style="list-style-type: none"> Operate the remote control within about 23 ft (7 m).
	<ul style="list-style-type: none"> There is an obstacle in the path of the remote control and the unit. 	<ul style="list-style-type: none"> Remove the obstacle.
	<ul style="list-style-type: none"> The batteries in the remote control are exhausted. 	<ul style="list-style-type: none"> Replace the batteries with new ones.

Additional Information

About MP3

- An MP3 file is audio data compressed by using the MPEG1 audio layer-3 file-coding scheme. We call files that have the ".mp3" file extension "MP3 files".
- The unit can not read an MP3 file that has not ".mp3" file extension.

About WMA

- An WMA file is a Microsoft audio compression technology.
- WMA(Windows Media Audio) offers double the audio compression of the MP3 format.

MP3/WMA Disc compatibility with this unit is limited as follows:

- Sampling Frequency / 8 - 48kHz (MP3), 32 - 44.1 kHz (WMA)
- Bit rate / 8 - 320kbps (MP3), 32 - 128kbps (WMA)
- CD-R physical format should be "ISO 9660"
- If you record MP3/WMA files using the software which cannot create a FILE SYSTEM, for example "Direct-CD" etc., it is impossible to playback MP3 files. We recommend that you use "Easy-CD Creator", which creates an ISO9660 file system.

- File names should be named using 30 letters or less and must incorporate ".mp3" or "wma" extension e.g. "*****.MP3" or "*****.WMA".
- Do not use special letters such as "/ : * ? " < > " etc.
- Even if the total number of files on the disc have more than 1000, it will only be shown up to 999.

About MULTI SESSION

- This function recognizes the multi session disc according to a disc of CD-ROM type.

- ex) If there are MP3/WMA files in the first session, the MP3/WMA file in the first session is only played. If there are only MP3/WMA files in the whole session, all of the MP3/WMA files in the session are played. If there is Audio CD in the first session, only the Audio CD in the first session is played.

Specifications

SECTION		MODEL	LM-U1350A/D/X	LM-U1050A/D/X	LM-W550A/D/X LM-U550A/D/X
[General]	Power supply	Refer to the back panel of the unit.			
	Power consumption	60 W	50 W	45 W	
	Mass	6.3 kg	6.3 kg	6.3 kg	
	External dimensions (W x H x D)	273 x 326 x 366 mm			
[CD]	Frequency response	40 - 18000 Hz			
	Signal-to-noise ratio	70 dB			
	Dynamic range	70 dB			
[Tuner]	FM	Tuning Range	87.5 - 108.0 MHz or 65 - 74 MHz, 87.5 - 108.0 MHz		
		Intermediate Frequency	10.7 MHz		
		Signal to Noise Ratio	60/55 dB		
		Frequency Response	60 - 10000 Hz		
	AM (MW)	Tuning Range	522 - 1620 kHz or 520 - 1720 kHz		
		Intermediate Frequency	450 kHz		
		Signal to Noise Ratio	35 dB		
		Frequency Response	120 - 2000 Hz		
[Amp]	Output Power	130W+130W	100W+100W	50W+50W	
	T.H.D	0.5 %			
	Frequency Response	42 - 20000 Hz			
	Signal-to-noise ratio	75 dB			
[TAPE]	Tape Speed	4.75 cm/sec			
	Wow Flutter	0.25 %(MTT -111, JIS-WTD)			
	F.F/REW Time	120 sec (C-60)			
	Frequency Response	125 - 8000Hz			
	Signal to Noise Ratio	40 dB			
	Channel Separation	50 dB(P/B) / 45 dB(R/P)			
	Erase Ratio	55 dB(MTT-5511)			
[Speakers]		LMS-U1350	LMS-U1050	LMS-W550/U550	
	Type	3 Way 3 Speaker	3 Way 3 Speaker	2 Way 2 Speaker	
	Impedance	4 Ω	4 Ω	8 Ω	
	Frequency Response	50 - 20000 Hz	55 - 20000 Hz	56 - 20000 Hz	
	Sound Pressure Level	86 dB/W (1m)	85 dB/W (1m)	85 dB/W (1m)	
	Rated Input Power	130 W	100 W	50 W	
	Max. Input Power	260 W	200 W	100 W	
	Net Dimensions (W x H x D)	227 X 327 X 312 mm	227 X 327 X 272 mm	199 X 326 X 232 mm	
Net Weight	5 kg	4.2 kg	2.78 kg		

* Designs and specifications are subject to change without notice.

