



LG Electronics Inc.

LG Twin Tower, 20, Yoido-Dong, Youngdungpo-Gu, Seoul, 150-721, Korea.
<http://www.lge.co.kr>



FRIDGE-FREEZER USER'S GUIDE

Please read this User's Guide carefully before operating and keep it handy for reference at all times.

CHLADNIČKA S MRAZNIČKOU NÁVOD K OBSLUZE

Prosím, před použitím přístroje si tento návod k obsluze pečlivě přečtěte a mějte jej vždy při ruce, abyste do něj mohli kdykoli nahlédnout.



Table of Contents

Introduction	Registration 4
	Important Safety Instruction 4
	Identification of Parts 9
Installation	Installation 10
	Starting 10
Operation	Temperature Control 11
	Vacation 12
	Super Freezer 12
	Moving Basket 12
	Self Test 13
	Door Alarm 13
	Ice Making 13
	Defrosting 13
Suggestion On Food storage	Storing Food 14
Care and Maintenance	General Information 16
	Lamp Replacement 17
	To Reverse the Doors 17
	Cleaning 18
Trouble Shooting	Trouble Shooting 19

Introduction

Registration

The model and serial number are found on the rear of this unit. This number is unique to this unit and not available to others. You should record requested information here and retain this guide as a permanent record of your purchase. Staple your receipt here.

Date of Purchase : _____

Dealer Purchased From : _____

Dealer Address : _____

Dealer Phone No. : _____

Model No. : _____

Serial No. : _____

Important Safety Instruction

To avoid any risk of personal injury, material damage or incorrect use of the appliance, be sure to observe the following safety precautions. (After reading these owner's instructions, please keep them in a safe place for reference). Remember to hand them over to any subsequent owner.

Warning Indicates that a danger of death or serious injury exists

Caution Indicates that a risk of personal injury or material damage exists

Important Safety Instruction

Precaution

▲ Warning

- This fridge-freezer must be properly installed and located in accordance with the Installation Instruction before it is used.
- Never unplug your fridge-freezer by pulling on the power cord. Always grip plug firmly and pull straight out from the outlet.
- When moving your appliance away from the wall, be careful not to roll over or damage the power cord.
- After your fridge-freezer is in operation, do not touch the cold surfaces in the freezer compartment, particularly when hands are damp or wet. Skin may adhere to these extremely cold surfaces.
- Pull out the power plug prior to cleaning the fridge-freezer.
Never damage, severely bend, pull out, or twist the power cord because power cord damage may cause a fire or electronic shock.
Never place glass products in the freezer because they may be broken when their inner contents are frozen.
- Do not directly spray water inside or outside the fridge/freezer.
There is a risk of explosion or fire.
- Do not insert the power plug with wet hands.
You may receive an electric shock.
- Do not put a container filled with water on top of the appliance.
If the water spills on to any electrical parts, it may lead to fire or electric shock.
- Do not install the fridge/freezer in a damp place, where it could be splashed with water.
Incorrect insulation of the electrical parts may cause an electric shock or fire.

Important Safety Instruction

- Do not disassemble, repair or alter the appliance. It may cause fire or abnormal operations, which may lead to injury.
- Pull the power plug out of the socket before replacing the interior light in the refrigerator. Otherwise, there is a risk of electric shock.
- If possible, connect the fridge-freezer to its own individual electrical outlet to prevent it and other appliances or household lights from causing an overload.

It will cause electric shock or fire.

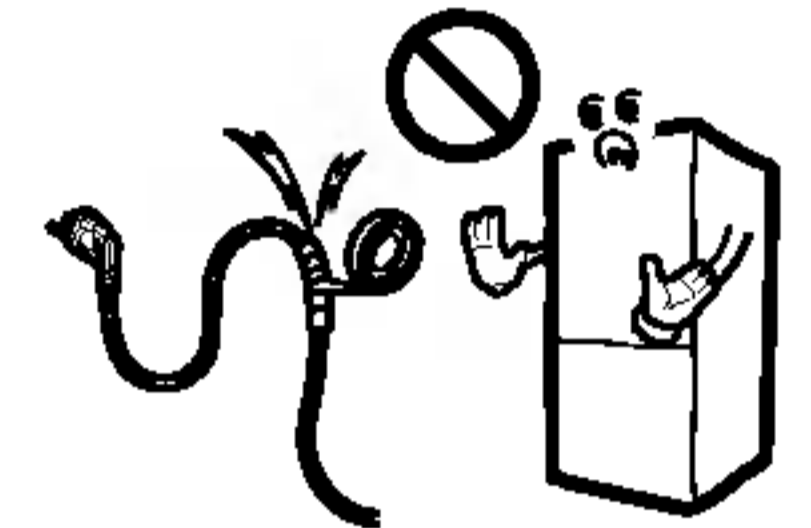

Do not modify or extend the Power Cord length

Accessibility of Supply Plug

Supply Cord Replacement

Danger

Don't store

Grounding (Earthing)

The supply plug of the refrigerator-freezer should be placed in easy accessible position for quick disconnection in emergency.

If the supply cord is damaged, it must be replaced by the manufacturer or its service agent or a similarly qualified person in order to avoid a hazard.

Risk of child entrapment.

Before you throw away your old refrigerator or freezer: Take off the doors.

Leave the shelves in place so that children may not easily climb inside.

Don't store or use gasoline or other flammable vapors and liquids in the vicinity of this or any other appliance.

In the event of an electric short circuit, grounding (earthing) reduces the risk of electric shock by providing an escape wire for the electric current. In order to prevent possible electric shock, this appliance must be grounded. Improper use of the grounding plug can result in an electric shock. Consult a qualified electrician or service person if the grounding instructions are not completely understood, or if you have doubts on whether the appliance is properly grounded.

Important Safety Instruction

⚠ Warning

- ⚠ Keep ventilation openings, in the appliance enclosure or in the built-in structure, clear of obstruction.
- ⚠ Do not use mechanical devices or other means to accelerate the defrosting process, other than those recommended by the manufacturer.
- ⚠ Do not damage the refrigerant circuit.
- ⚠ Do not use electrical appliances inside the food storage compartments of the appliance, unless they are of the type recommended by the manufacturer.
- ⚠ The refrigerant and insulation blowing gas used in the appliance require special disposal procedures. When disposal, please consult with service agent or a similarly qualified person.



This appliance contains a small amount of isobutane refrigerant (R600a), natural gas with high environmental compatibility, but it is also combustible. When transporting and installing the appliance, care should be taken to ensure that no parts of the refrigerating circuit are damaged. Refrigerant squirting out of the pipes could ignite or cause an eye injury. If a leak is detected, avoid any naked flames or potential sources of ignition and air the room in which the appliance is standing for several minutes.

In order to avoid the creation of a flammable gas air mixture if a leak in the refrigerating circuit occurs, the size of the room in which the appliance may be sited depends on the amount of refrigerant used. The room must be 1 m² in size for every 8g of R600a refrigerant inside the appliance. The amount of refrigerant in your particular appliance is shown on the identification plate inside the appliance.

Never start up an appliance showing any signs of damage. If in doubt, consult your dealer.

⚠ Caution

Important Safety Instruction

- If the wall socket is loose, do not insert the power plug.
It may cause electric shock or fire.
- Never unplug your refrigerator by pulling on the power cord. Always grip plug firmly and pull it straight out from the outlet.
You may disconnect a wire and cause a short circuit.
- Do not use a wet or damp cloth when cleaning the plug. Remove any foreign matter from the power plug pins.
Otherwise, there is a risk of fire.
- Do not put your hands into the bottom area of the appliance.
Any Sharp edges may cause personal injury..
- After unplugging the appliance, wait for at least five minutes before plugging it again to the wall socket.
Abnormal operation of the freezer may cause material damage.
- If the appliance is not to be used for a long time, pull out the power plug.
Any deterioration in the insulation may cause fire.
- Do not let children touch or play with the control panel on the front of the appliance.
- The refrigerant used in fridge/freezer and the gases in the insulation material require special disposal procedures. Ensure that none of the pipes on the back of the appliances are damaged prior to disposal.

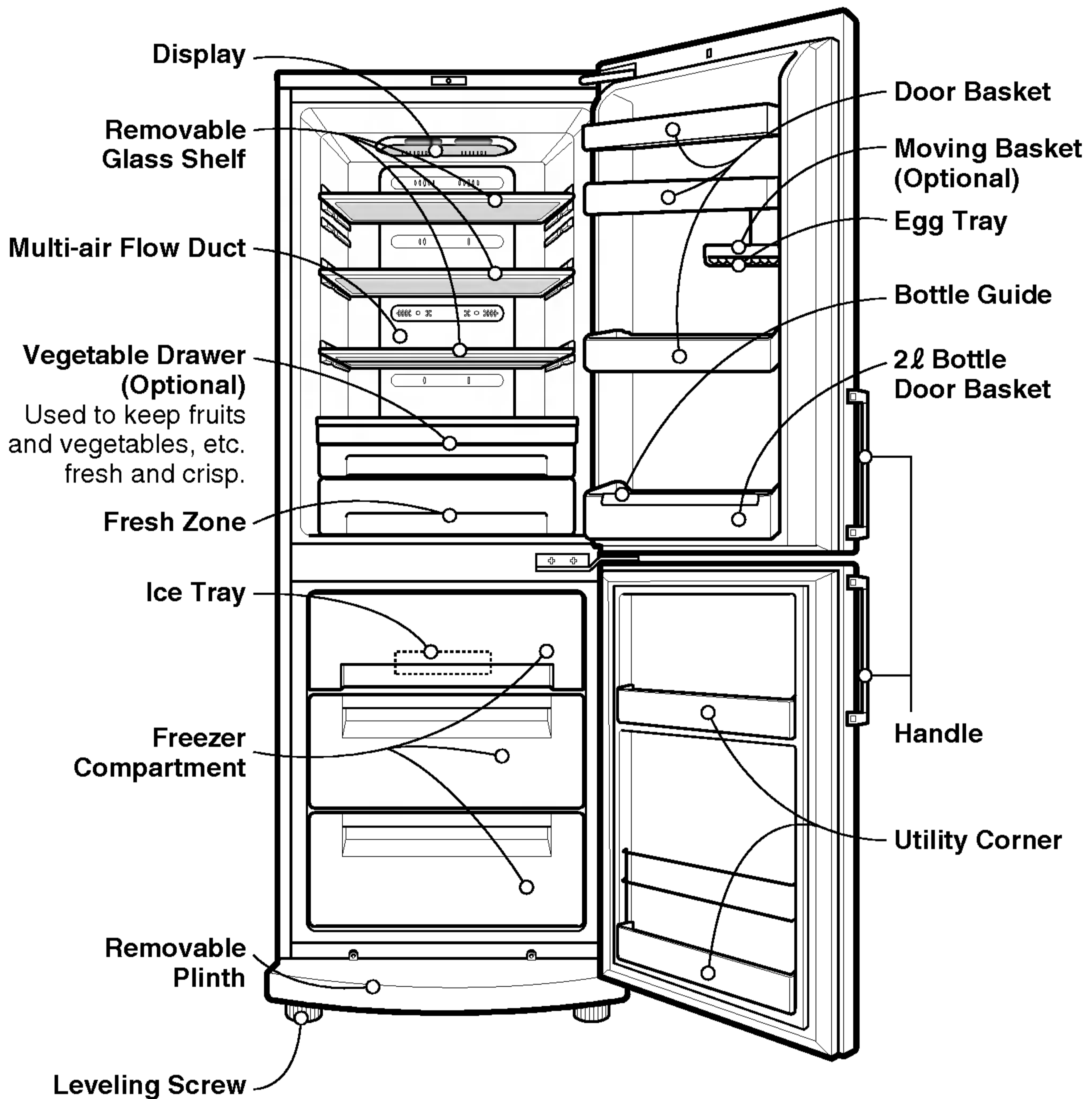

Identification of Parts



Note

If you find some parts missing from your unit, they may be parts only used in other models.

Installation

1. Select a good location.
Place your fridge-freezer where it is easy to use.
2. Avoid placing the unit near heat sources, direct sunlight or moisture.
3. There must be proper air circulation around your fridge-freezer to keep it operating efficiently.
If your fridge-freezer is placed in a recessed area in the wall, allow at least 2 inches(5 cm) above.
4. To avoid vibration, the unit must be leveled.
If required, adjust the leveling screws to compensate for the uneven floor.
The front should be slightly higher than the rear to aid in door closing.
Leveling screws can be turned easily by tipping the cabinet slightly.
Turn the leveling screws counterclockwise() to raise the unit, clockwise() to lower it.
5. Clean your fridge-freezer thoroughly and wipe off all dust accumulated during shipping.
6. Install accessories such as ice cube box, etc., in their proper places. They are packed together to prevent possible damage during shipment.
7. Connect the power supply cord (or plug) to the outlet.
Don't double up with other appliances on the same outlet.

Starting

When your fridge-freezer is installed, allow it 2-3 hours to stabilize at normal operating temperature prior to filling it with fresh or frozen foods.
If power plug is disconnected, allow 5 minutes delay before restarting.
Your fridge-freezer is now ready for use.

Temperature Control

- Your fridge-freezer has controls that let you regulate the temperature in the fridge and freezer compartments. These controls are on the top of the fridge-freezer.

Fridge

- Initially set the TEMP(erature) CONTROL at "3". Then adjust the compartment temperature according to your desire.

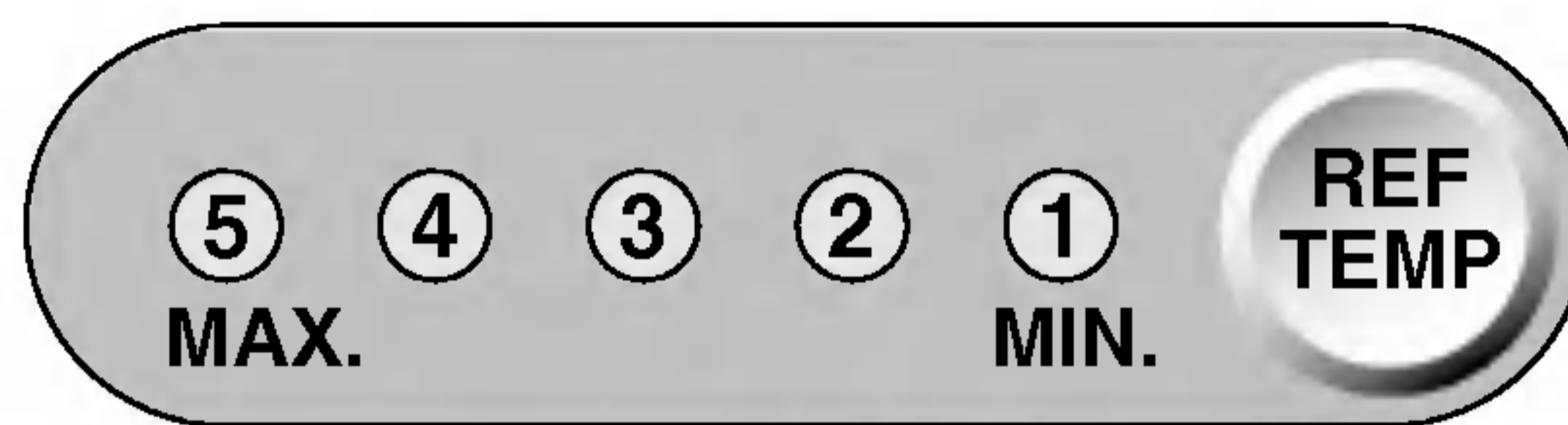

- By pressing the REF.TEMP (Refrigerator Temperature) button, you can adjust the temperature of the Refrigerator as indicated by the numbers of lamps it. (the setting is composed of five steps, 5 lamps it indicates coldest.)
- When you are starting the Fridge-Freezer or connecting the power plug to the outlet, temperature setting is automatically set to the "3".

Freezer

- Initially set the TEMP. (erature) CONTROL at "3". Then adjust the compartment temperature according to your desire.

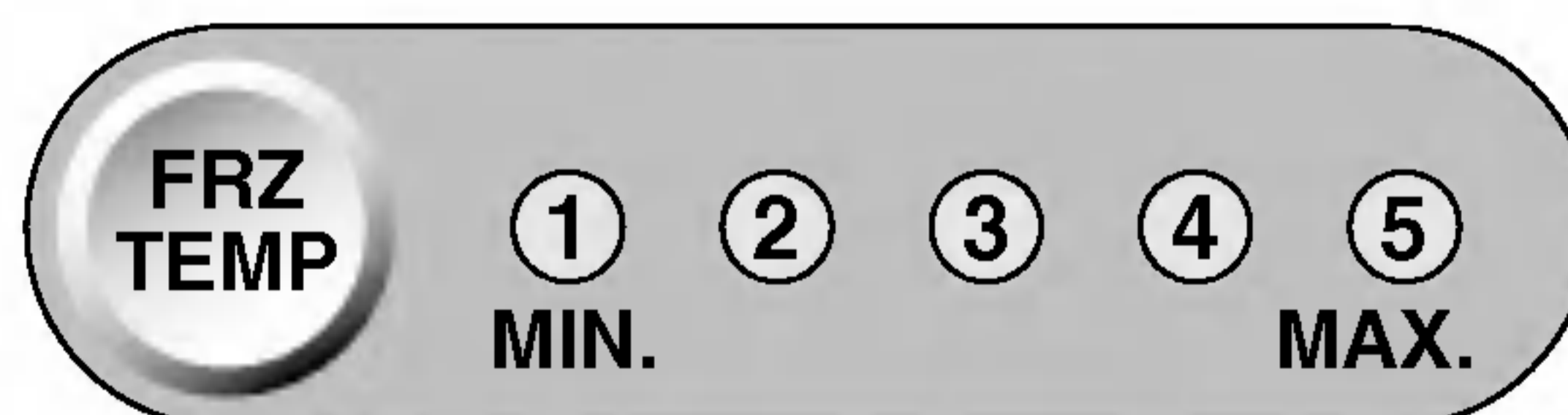

- By pressing the FRZ. TEMP (Freezer Temperature) button, you can adjust the temperature of the Freezer as indicated by the numbers of lamps it. (the setting is composed of five steps, 5 lamps it indicates coldest.)
- When you are starting the Fridge-Freezer or connecting the power plug to the outlet, temperature setting is automatically set to the "3".

Vacation

- This function makes the fridge-freezer work in a power saving mode which is useful when you are away on holiday, by reducing energy consumption as much as possible. Pressing 'VACATION' starts operation with lamp ON and pressing it again stops the operation.



Super Freezer

- This function is used when you want to freeze the foods quickly. Press the SUPER FRZ (Super Freezer) button once, and then the quick freeze operation starts with the lamp it.
- The Super Freeze operation takes about 3 hours. When its operation ends, it automatically returns to the normal state. If you want to stop the quick freeze operation, press the SUPER FRZ button once more, the lamp goes out, and the Super Freeze operation stops and the refrigerator returns to the normal state.



Moving Basket

1. This Basket Door can be moved side to side by sliding right or left.
2. To remove the Moving Basket, first of all remove front moving basket, and lift until bin up bottom of basket unclicks and pull straight out.
3. Put back the Moving Basket by sliding it above the desired support slot and firmly bush down until it locks in place. Now put the front Moving Basket back to its support.

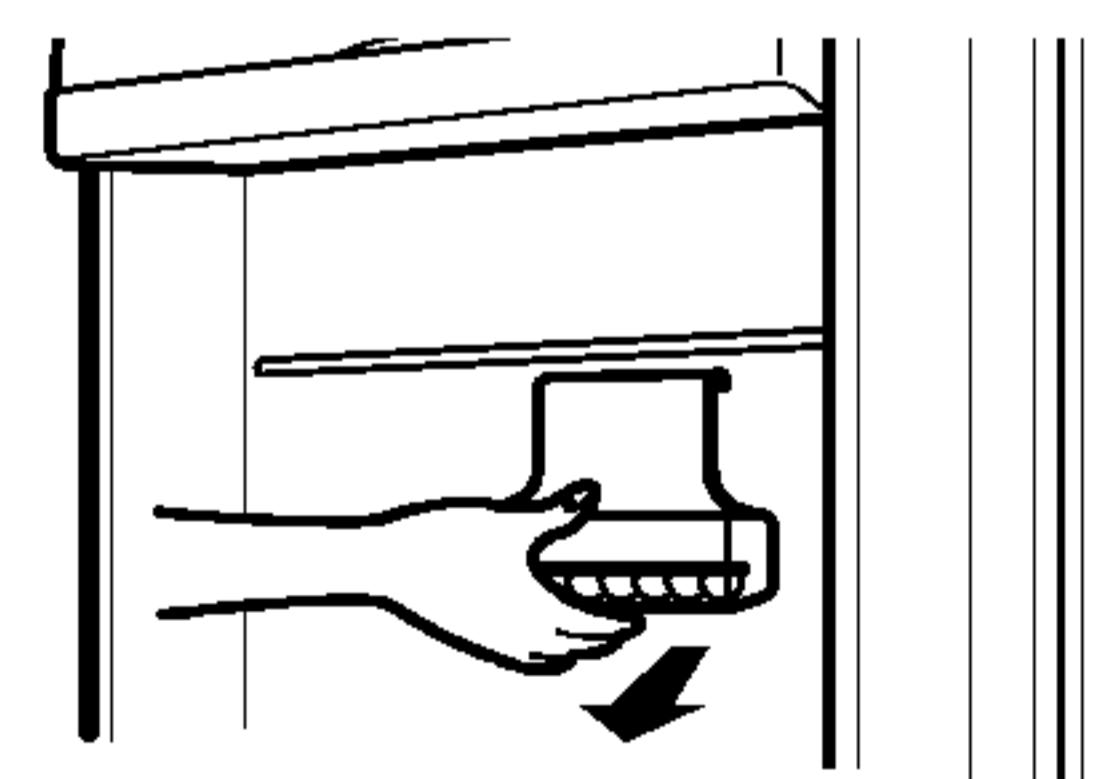
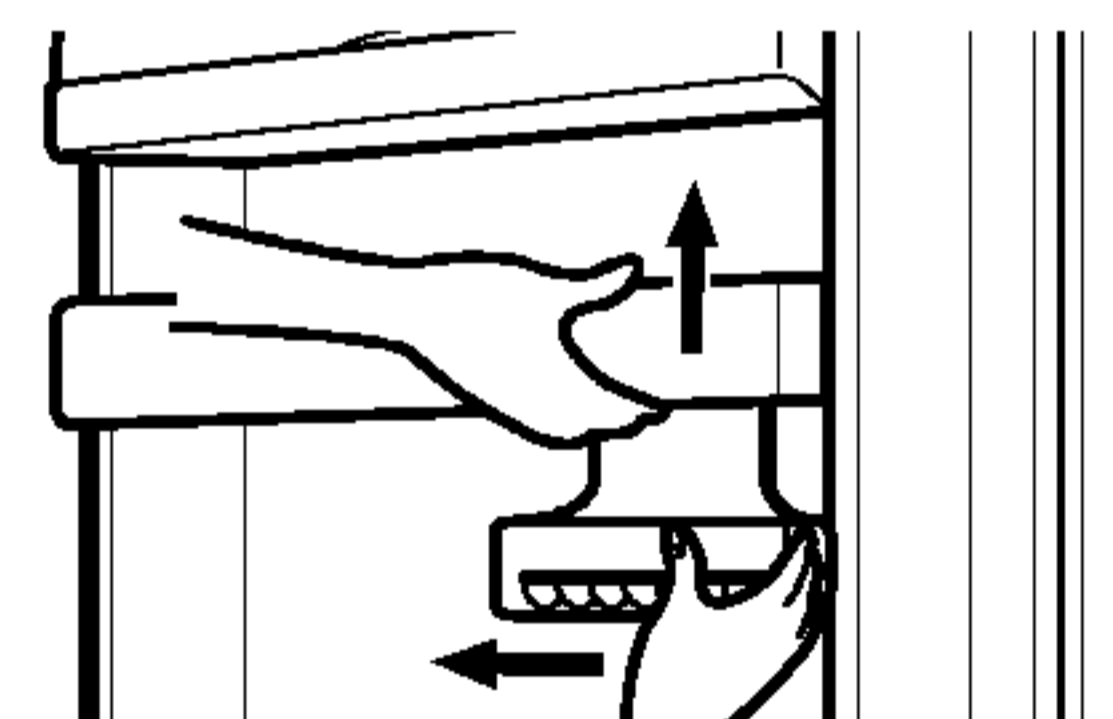

Note

When you move the basket, you had better push the basket bottom side. (like this drawing)

Self Test

This function allows you to check for operational problems. If you think you have a problem with your fridge-freezer, then press the temperature control button:

- If the indicate lights move up or down, then there is no problem with your fridge-freezer.
- If the indicate lights do not move up or down, then please leave the power connected and call your nearest service agent.

Door Alarm

When the door of the fridge is left opened for a while, the alarm sounds.

Ice Making

- To make ice cubes, fill the ice tray to the water level and place it in the freezer.
- If ice cubes are required fast, press the 'SUPER FRZ.' button.
- To remove ice cubes, hold the tray at its ends and twist gently.

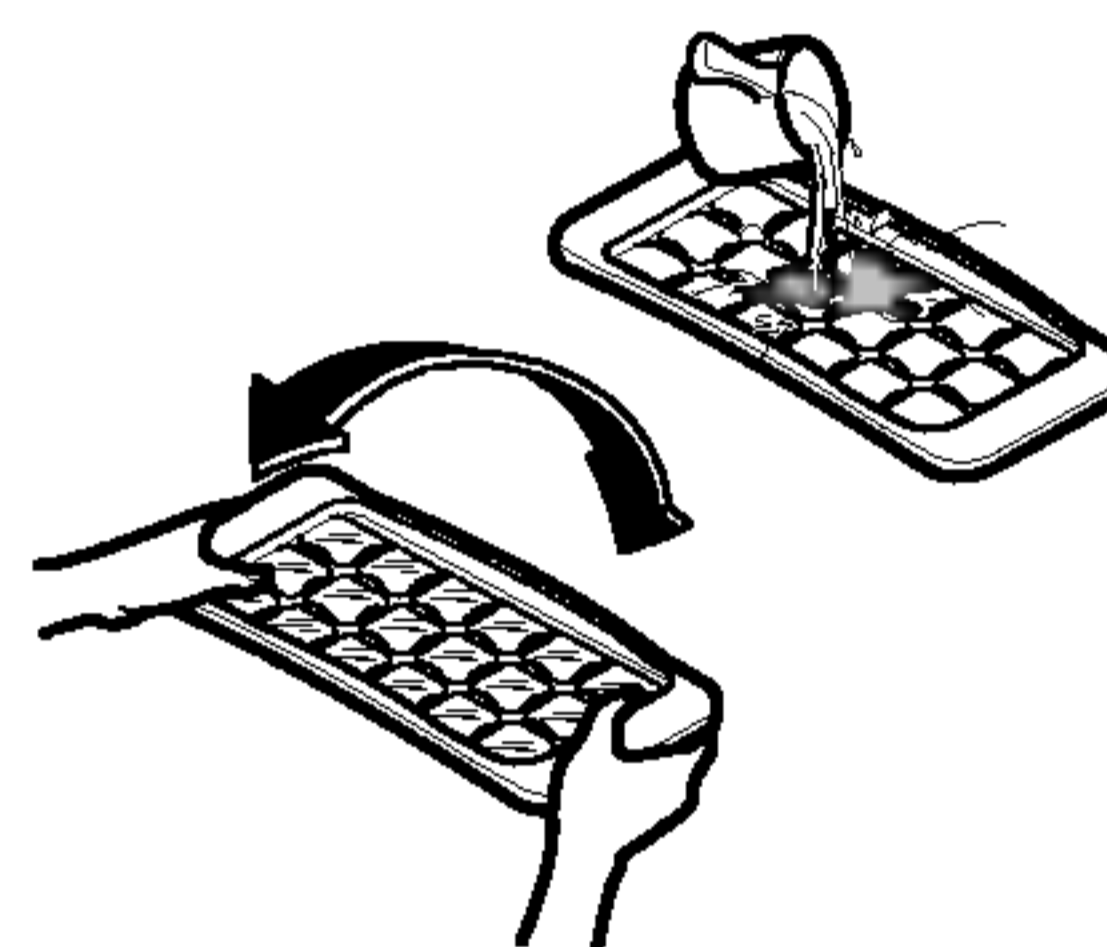

Tip

To remove ice cubes easily, run water on the tray before twisting.

Defrosting

Defrosting takes place automatically. The defrosting water flows down to the evaporating tray and is evaporated automatically.

Storing Food

⚠ Caution

- Do not store food which goes bad easily at low temperature, such as banana, and melon.
- Allow hot food to cool prior to storing. Placing hot food in the fridge-freezer could spoil other food, and lead to higher electric bills.
- When storing the food, use a container with a lid. This prevents moisture from evaporating, and helps food to keep its taste and nutrients.
- Do not block air vents with food. Smooth circulation of cold air keeps fridge-freezer temperature even.
- Do not open the door frequently. Opening the door lets warm air enter the fridge-freezer, and cause temperature to rise.
- Never keep too many foods in door rack, as this may stop the door from fully closing.
- Do not store bottles in the freezer compartment - they may break when frozen.
- Do not refreeze food that has been thawed. This causes loss of taste and nutrition.
- Do not store pharmaceutical products, scientific materials or other temperature sensitive products in the refrigerator.

Products that require strict temperature controls must not be stored in the refrigerator.

Suggestions on food storage

- Freezer Door Basket, marked **✖✖** is -12°C compartment, that is suitable for short term storage of frozen food.
- If you want to quick freeze new food, you put it middle drawer of freezer compartment, and then press the Super Freezer button.
- Do not put in front of the air hole of the upper drawer of freezer compartment. It could decrease freezer capacity.

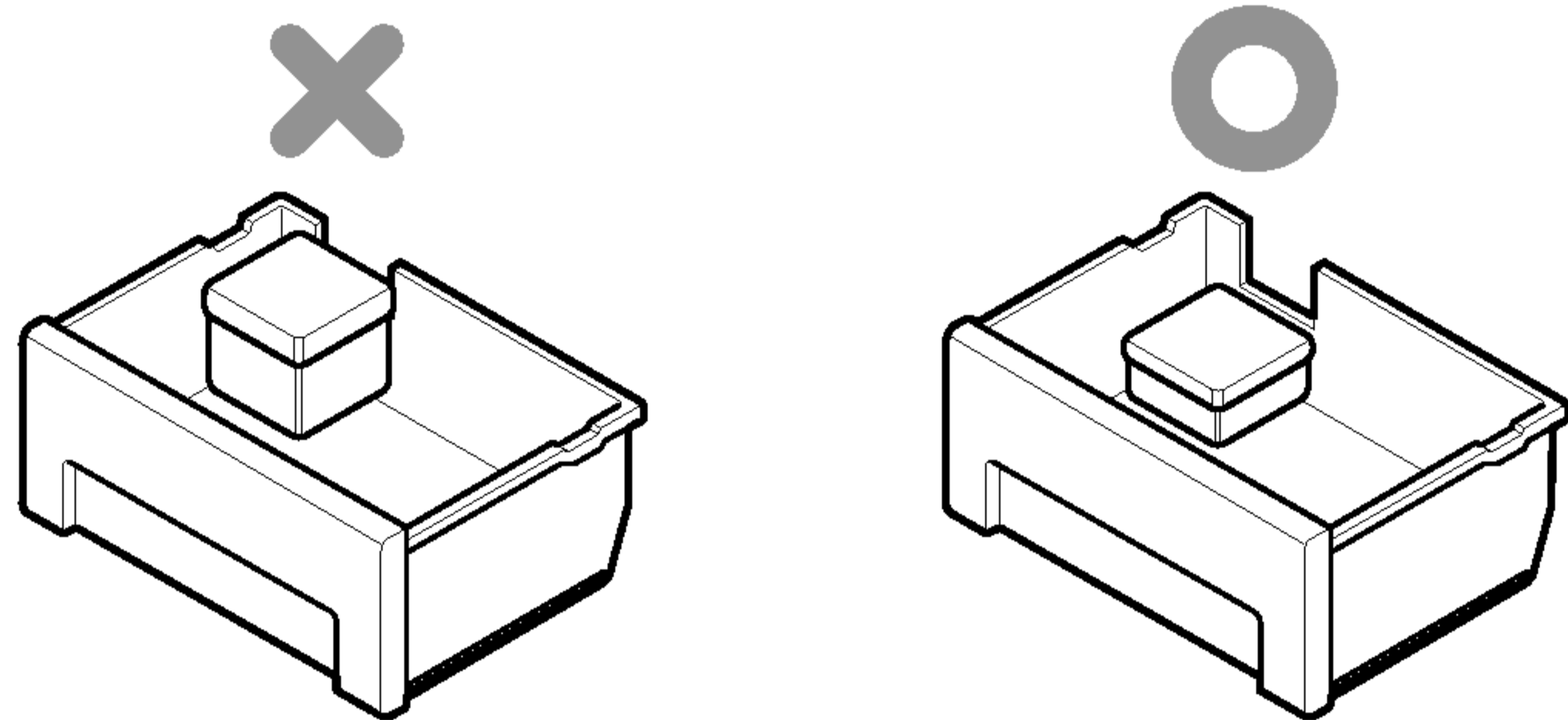

Note

If you keep the fridge-freezer in a hot, and humid place, frequently open its door or put a lot of vegetables in it, dew may form in it, which has no effect on its performance.

Remove the dew with dust cloth free from care.

General Information

Power Failure

- 1~2 hour power failure does no harm to the foods stores. Try to avoid opening and closing the door too frequently.

If You Move

- Take out foods from the fridge-freezer and firmly fix the loose items with tape.
- Turn the leveling screws until they stop before moving the fridge-freezer. Otherwise the screw may scratch the floor or the fridge-freezer cannot move.

Anti Condensation Pipe

- The Anti-Condensation pipe is installed around the front side of fridge-freezer as well as on the partition between fridge compartment and freezer compartment to prevent dewing.

Anti-Condensation Pipe

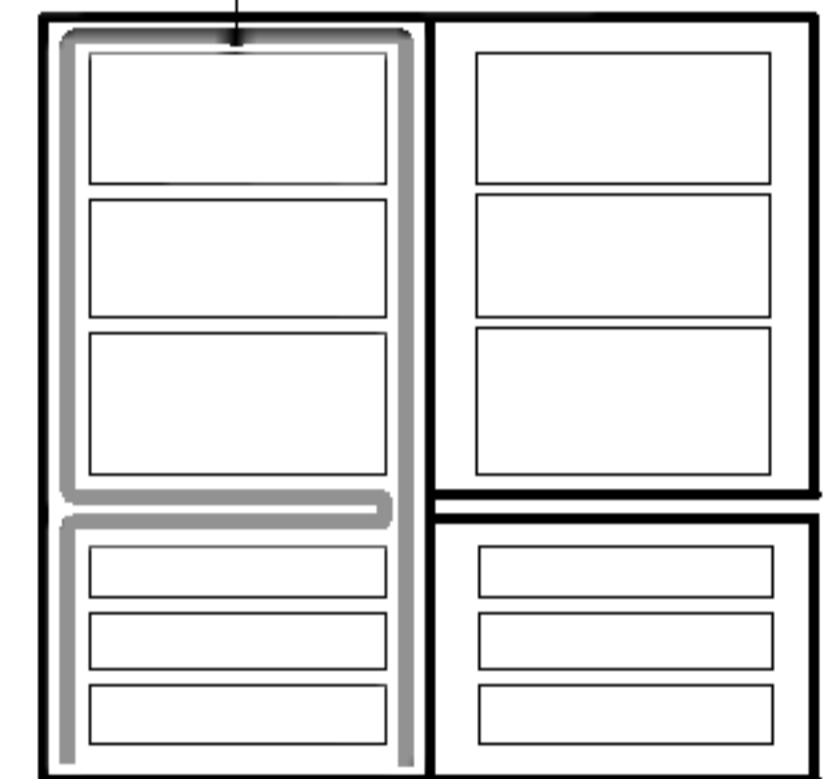

- Especially after installation or when ambient temperature is high, the fridge-freezer may feel hot, which is quite normal.

Lamp Replacement

1. Unplug the power cord from the outlet.
2. Remove the room lamp lid by taking down while pulling its back projection.
3. Remove the lamp by turning it counterclockwise and replace new one.
4. Assemble in reverse order of disassembly. Replacement bulb must be the same specification as original.

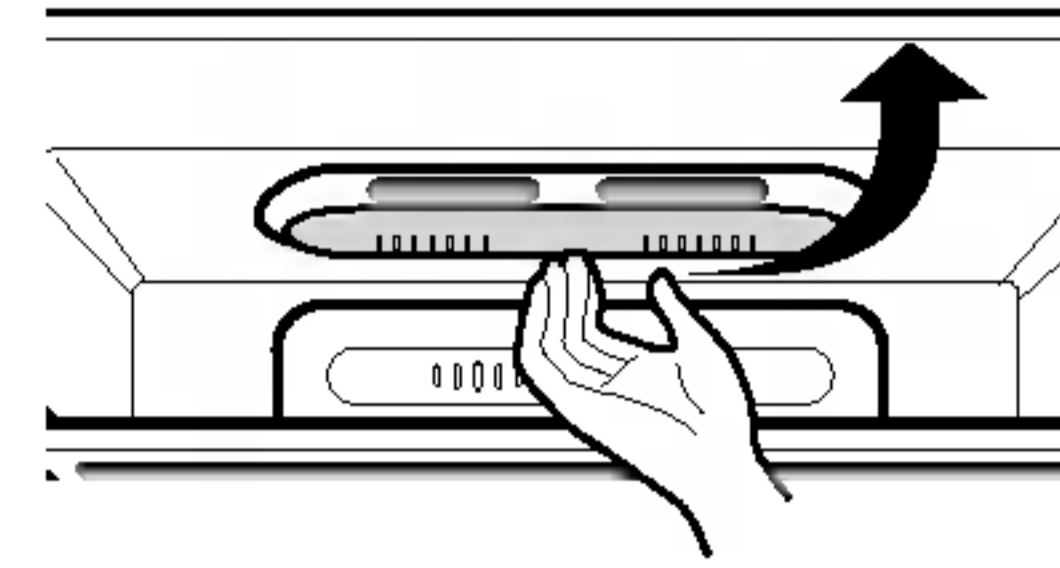

⚠ Caution

- You must check the O-RING, which is made by rubber and prevent electric spark.
- Don't touch the lamp, in case of light on the long time. Because it can be very hot.

Note

- Lamp capacity is MAX 30W.
- The lamp will remain "ON" for 7minutes if the door is left open and then it is "OFF" for safety. (If you reopen the door, the lamp is "On".)

To Reverse the Doors

- Your fridge-freezer is designed with reversible doors, do that they may open from either the left of right hand side to suit your kitchen design.

⚠ Caution

However, When you want to reverse the doors, you must be calling to service agent.

Cleaning

Before Cleaning

Be sure to unplug the power.

Exterior

Clean the outside of the fridge-freezer with a soft cloth soaked with hot water or liquid detergent. If you use a detergent, be sure to wipe it with a clean wet cloth.

Interior

As above.

After Cleaning

Check that the power cord is not damaged, power plug has not overheated, and that the power plug is tightly inserted into the outlet.

Warning

Be sure to dry the appliance with a cloth after washing it with water.

Do not use abrasive, petroleum, benzene, thinner, hydrochloride acid, boiling water, rough brush, etc, as they may damage parts of the fridge-freezer.

Before calling for service, check this list. It may save you both time and expense. This list includes common occurrences that are not the result of defective workmanship or materials in this appliance.

Problem

Possible Causes

Fridge-Freezer does not operate

- Power plug may be unplugged from the electric outlet.
Plug it in securely.
- House fuse has blown or circuit breaker has tripped.
Check and/or replace fuse and reset circuit breaker.
- Power cut.
Check house lights.

Fridge or Freezer Compartment Temperature too warm

- Temperature control not set on proper position.
Refer to Temperature Control section.
- Appliance is placed close to heat source.
- Warm weather-frequent door openings.
- Door left open for a long time.
- Package holding door open or blocking air duct in freezer compartment.

Vibration or Rattling or Abnormal Noise

- The floor on which the fridge-freezer is installed may be uneven or the fridge-freezer may be unstable.
Make it even by rotating the leveling screw.
- Unnecessary objects placed in the back side of the fridge-freezer.

Frost or Ice Crystals on frozen Food

- Door may have been left ajar or package holding door open.
- Too frequent or too long door openings.
- Frost within package is normal.

Moisture forms on Cabinet Surface

- This phenomenon is likely to occur in a wet space.
Wipe it with a dry towel.

Problem	Possible Causes
Moisture collects inside	<ul style="list-style-type: none">• Too frequent or too long door openings.• In humid weather, air carries moisture into fridge when doors are opened.
Fridge has odor	<ul style="list-style-type: none">• Foods with strong odors should be tightly covered or wrapped.• Check for spoiled food.• Interior needs cleaning. Refer to CLEANING section
Door not closing properly	<ul style="list-style-type: none">• Food package is keeping door open. Move packages that keep door from closing.• Fridge-freezer is not level. Adjust the leveling screws.• The floor on which the fridge-freezer is installed may be uneven or the fridge-freezer may be unstable. Slightly raise the front side with the leveling screw.
Interior light does not work	<ul style="list-style-type: none">• No power at outlet.• Light lamp needs replacing. Refer to the Lamp Replacement section

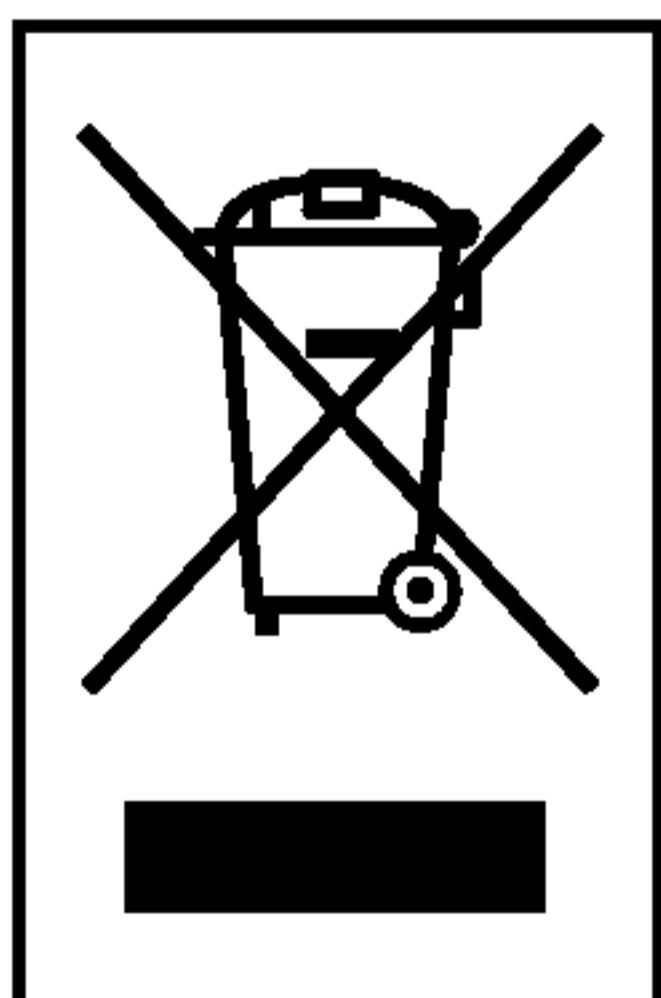

DISPOSAL OF YOUR OLD APPLIANCE

1. When this crossed-out wheeled bin symbol is attached to a product it means the product is covered by the European Directive 2002/96/EC.
2. All electrical and electronic products should be disposed of separately from the municipal waste stream via designated collection facilities appointed by the government or the local authorities.
3. The correct disposal of your old appliance will help prevent potential negative consequences for the environment and human health.
4. For more detailed information about disposal of your old appliance, please contact your city office, waste disposal service or the shop where you purchased the product.