



DVD PLAYER

OWNER'S MANUAL

MODEL : DS9321P/DS9521P/
DV9721P



Before connecting, operating or adjusting this product,
please read this instruction booklet carefully and completely.





CAUTION
RISK OF ELECTRIC SHOCK
DO NOT OPEN



CAUTION: THESE SERVICING INSTRUCTIONS ARE FOR USE BY QUALIFIED SERVICE PERSONNEL ONLY. TO REDUCE THE RISK OF ELECTRIC SHOCK DO NOT PERFORM ANY SERVICING OTHER THAN THAT CONTAINED IN THE OPERATING INSTRUCTIONS UNLESS YOU ARE QUALIFIED TO DO SO.



Caution: The apparatus should not be exposed to water (dripping or splashing) and no objects filled with liquids, such as vases, should be placed on the apparatus.

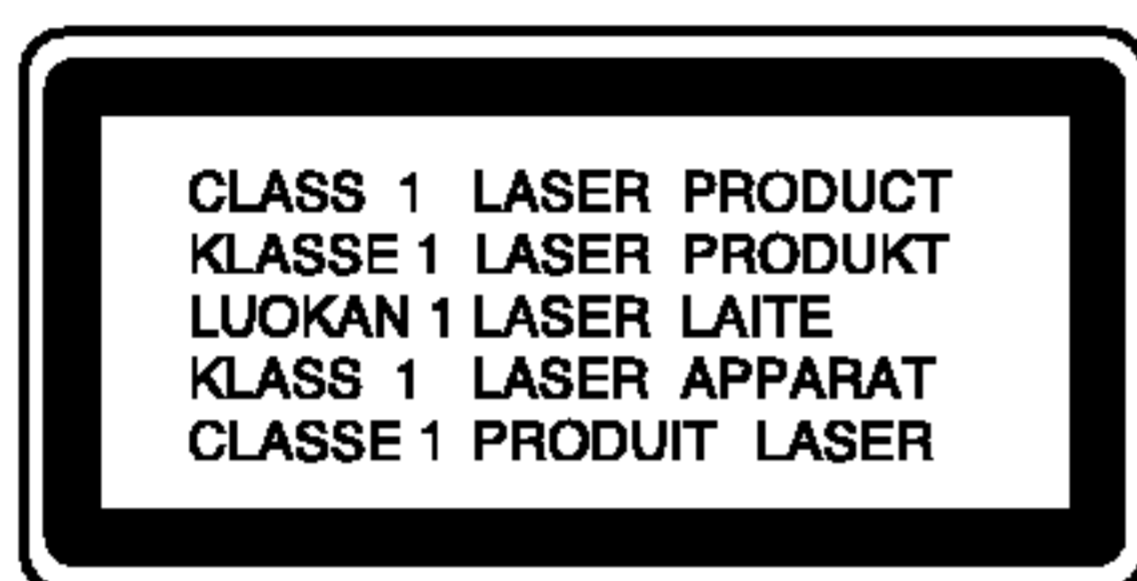

CAUTION: This product employs a Laser System.

To ensure proper use of this product, please read this owner's manual carefully and retain for future reference. Should the unit require maintenance, contact an authorized service center. Use of controls, adjustments, or the performance of procedures other than those specified herein may result in hazardous radiation exposure. To prevent direct exposure to laser beam, do not try to open the enclosure. Visible laser radiation when open. **DO NOT STARE INTO BEAM.**



WARNING: Do not install this equipment in a confined space such as a bookcase or similar unit.

CAUTION concerning the Power Cord

Most appliances recommend they be placed upon a dedicated circuit;

That is, a single outlet circuit which powers only that appliance and has no additional outlets or branch circuits. Check the specification page of this owner's manual to be certain.

Do not overload wall outlets. Overloaded wall outlets, loose or damaged wall outlets, extension cords, frayed power cords, or damaged or cracked wire insulation are dangerous. Any of these conditions could result in electric shock or fire. Periodically examine the cord of your appliance, and if its appearance indicates damage or deterioration, unplug it, discontinue use of the appliance, and have the cord replaced with an exact replacement part by an authorized servicer.

Protect the power cord from physical or mechanical abuse, such as being twisted, kinked, pinched, closed in a door, or walked upon. Pay particular attention to plugs, wall outlets, and the point where the cord exits the appliance.

SERIAL NUMBER:

You can find the serial number on the back of the unit. This number is unique to this unit and not available to others. You should record requested information here and retain this guide as a permanent record of your purchase.

Model No. _____

Serial No. _____

Date of Purchase _____

Contents

Introduction4

Symbol used in this Manual	4
About the  Symbol Display	4
Notes on Discs	4
Handling Discs	4
Storing Discs	4
Cleaning Discs	4
Types of Playable Discs	5
Regional code	5
Disc-related terms	6
Front Panel	7
Remote Control	8
Remote Control Operation	8
Remote Control Battery Installation	8

Installation and Setup9

Setting up the Player	9
DVD Player Connections	9
Video and Audio Connections to Your TV	9
Audio Connection to Your TV	9
Audio Connection to Optional Equipment	10
On-Screen Display	11
Playback Status/Restrictions	11
Initial Settings	12
General Operation	12
LANGUAGE	12
• Menu Language	12
• Disc Audio / Subtitle / Menu	12
DISPLAY	12
• TV Aspect	12
• Display Mode	12
• Progressive Scan	13
AUDIO	13
• Dolby Digital / DTS / MPEG	13
• Sample Freq. (Frequency)	13
• Dynamic Range Control (DRC)	14
• Vocal	14
OTHERS	14
• PBC	14
• Auto Play	14
• B.L.E.	14
LOCK (Parental Control)	15
• Rating	15
• Password (Security Code)	15
• Area Code	15

Operation16

Playing a DVD or Video CD	16
Playback Setup	16
General Features	16
Moving to another TITLE	16
Moving to another CHAPTER/TRACK	16
Search	16
Changing the Audio Channel	16
Still Picture and Frame-by-Frame Playback	17
Slow Motion	17
Random	17

Repeat A-B	17
Repeat	17
3D Surround	17
Time Search	17
Zoom	18
Marker Search	18
Special DVD Features	18
Checking the contents of DVD discs: Menus	18
Title Menu	18
Disc Menu	18
Camera Angle	18
Changing the Audio Language	18
Subtitles	18
Playing an Audio CD or MP3/WMA Disc	19
Audio CD and MP3 / WMA Disc Features	20
Pause	20
Moving to another Track	20
Repeat Track/All/Off	20
Search	20
Random	20
Repeat A-B	20
3D Surround	20
Programmed Playback	21
Repeat Programmed Tracks	21
Erasing a Track from Program List	21
Erasing the Complete Program List	21
Viewing a JPEG Disc	22
Slide Show	22
Still Picture	22
Moving to another File	22
Zoom	22
To rotate picture	22
To listen to MP3/WMA music watching picture	22
Maintenance and Service	23
Additional Features	24
Last Scene Memory	24
Screen Saver	24
Video Mode Setting	24
Controlling other TVs with the remote control	24
System Select	24

Reference25

Language Codes	25
Area Codes	25
Troubleshooting	26
Specifications	26

Introduction

To ensure proper use of this product, please read this owner's manual carefully and retain for future reference.

This manual provides information on the operation and maintenance of your DVD player. Should the unit require service, contact an authorized service location.

Symbol Used in this Manual



The lightning flash symbol alerts you to the presence of dangerous voltage within the product enclosure that may constitute a risk of electric shock.



The exclamation point alerts you to the presence of important operating and maintenance / servicing instructions.



Indicates hazards likely to cause harm to the unit itself or other material damage.





Note:

Indicates special notes and operating features.

Tip:

Indicates tips and hints for making the task easier.

A section whose title has one of the following symbols is applicable only to the disc represented by the symbol.

-  DVD and finalized DVD±R/RW
-  Video CDs
-  Audio CDs
-  MP3 Discs
-  WMA Discs
-  JPEG Discs

About the Symbol Display

"" may appear on your TV display during operation and indicates that the function explained in this owner's manual is not available on that specific DVD video disc.

Notes on Discs

Handling Discs

Do not touch the playback side of the disc. Hold the disc by the edges so that fingerprints do not get on the surface. Never stick paper or tape on the disc.



Storing Discs

After playing, store the disc in its case. Do not expose the disc to direct sunlight or sources of heat and never leave it in a parked car exposed to direct sunlight.

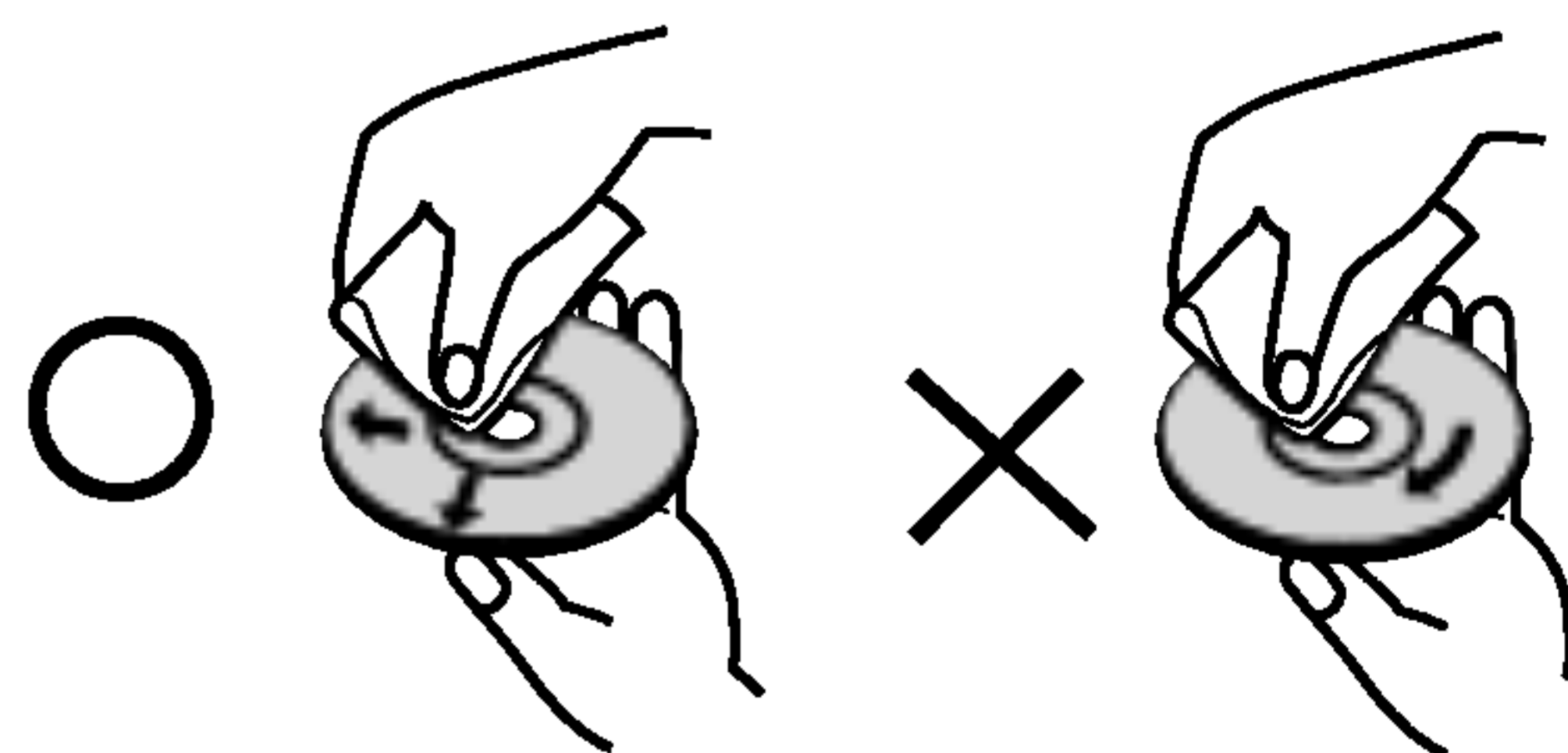

Cleaning Discs

Fingerprints and dust on the disc can cause poor picture quality and sound distortion. Before playing, clean the disc with a clean cloth. Wipe the disc from the center out.



Do not use strong solvents such as alcohol, benzine, thinner, commercially available cleaners, or anti-static spray intended for older vinyl records.

Types of Playable Discs

	DVD (8 cm / 12 cm disc)
	Video CD (VCD) (8 cm / 12 cm disc)
	Audio CD (8 cm / 12 cm disc)

In addition, this unit plays DVD -R, DVD +R, DVD -RW, DVD +RW, SVCD, and CD-R / CD-RW that contains audio titles, MP3, WMA, and/or JPEG files.

Notes:

- Depending on the conditions of the recording equipment or the CD-R/RW (or DVD -R, DVD +R, DVD -RW, DVD +RW) disc itself, some CD-R/RW (or DVD -R, DVD +R, DVD -RW, DVD +RW) discs cannot be played on the unit.
- Do not attach any seal or label to either side (the labeled side or the recorded side) of a disc.
- Do not use irregularly shaped CDs (e.g., heart-shaped or octagonal) since they may result in malfunctions.

Notes on DVDs and Video CDs

Some playback operations of DVDs and Video CDs may be intentionally programmed by software manufacturers. This unit plays DVDs and Video CDs according to disc content designed by the software manufacturer, therefore some playback features may not be available or other functions may be added.

Manufactured under license from Dolby Laboratories. "Dolby", "Pro Logic", and the double-D symbol are trademarks of Dolby Laboratories.

DTS and DTS Digital Out are trademarks of Digital Theater Systems, Inc.

Regional code

This DVD player is designed and manufactured for playback of region "3" encoded DVD software. This unit can play only DVD discs labeled "3" or "ALL".



Notes on Regional Codes

- Most DVD discs have a globe with one or more numbers in it clearly visible on the cover. This number must match your DVD player's regional code or the disc cannot play.
- If you try to play a DVD with a different region code from your player, the message "Check Regional Code" appears on the TV screen.

Notes on Copyrights:

It is forbidden by law to copy, broadcast, show, broadcast via cable, play in public, or rent copyrighted material without permission. This product features the copy protection function developed by Macrovision. Copy protection signals are recorded on some discs. When recording and playing the pictures of these discs picture noise will appear. This product incorporates copyright protection technology that is protected by method claims of certain U.S. patents and other intellectual property rights owned by Macrovision Corporation and other rights owners. Use of this copyright protection technology must be authorized by Macrovision Corporation, and is intended for home and other limited viewing uses only unless otherwise authorized by Macrovision Corporation. Reverse engineering or disassembly is prohibited.

CONSUMERS SHOULD NOTE THAT NOT ALL HIGH DEFINITION TELEVISION SETS ARE FULLY COMPATIBLE WITH THIS PRODUCT AND MAY CAUSE ARTIFACTS TO BE DISPLAYED IN THE PICTURE. IN CASE OF 525 OR 625 PROGRESSIVE SCAN PICTURE PROBLEMS, IT IS RECOMMENDED THAT THE USER SWITCH THE CONNECTION TO THE 'STANDARD DEFINITION' OUTPUT. IF THERE ARE QUESTIONS REGARDING OUR TV SET COMPATIBILITY WITH THIS MODEL 525p AND 625p DVD PLAYER, PLEASE CONTACT OUR CUSTOMER SERVICE CENTER.

Disc-related terms

DVD ±R / DVD ±RW

DVD -R and DVD +R are two different standards for recordable DVD drives and discs. This format allows information to be recorded onto the DVD disc only once. DVD +RW and DVD -RW are two standards for re-writable media, meaning the DVD content can be erased and re-recorded.

VCD (Video CD)

A VCD holds up to 74 minutes (650 MB disc) or 80 minutes (700 MB disc) of MPEG-1 full-motion video along with quality stereo sound.

MPEG

MPEG is an international standard for video and audio compression. MPEG-1 is used in encoding video for VCD and provides for multichannel surround sound coding such as PCM, Dolby Digital, DTS and MPEG audio.

MP3

MP3 is a popular compression format used for digital audio files that yields very high near-CD quality.

WMA

Windows media audio file. A type of coding / decoding developed by Microsoft Corp.

JPEG

Joint Pictures Expert Group. JPEG is a compressed file format that allows you to save images with no limit on the number of colors.

PBC: Playback Control (Video CD only)

Playback control is available for Video CD (VCD) version 2.0 disc formats. PBC allows you to interact with the system via menus, search functions, or other typical computer-like operations. Moreover, still pictures of high resolution can be played if they are included in the disc. Video CDs not equipped with PBC (Version 1.1) operate in the same way as audio CDs.

Title (DVD video discs only)

A title is generally a distinct section of a DVD disc. For example the main feature could be title 1, a documentary describing how the film was made could be title 2, and cast interviews could be title 3. Each title is assigned a reference number enabling you to locate it easily.

Chapter (DVD video discs only)

A chapter is a segment of a title such as a scene in a film or one interview in a series. Each chapter is assigned a chapter number, enabling you to locate the chapter you want. Depending on the disc, chapters may not be recorded.

Scene (VCD)

On a video CD with PBC (playback control) functions, moving pictures and still pictures are divided into sections called "scenes". Each scene is displayed in the menu screen and assigned a scene number, enabling you to locate the scene you want. A scene is composed of one or several tracks.

Track

A distinct element of audiovisual information, such as the picture or sound track for a specific language (DVD), or a musical piece on a video or audio CD. Each track is assigned a track number, enabling you to locate the track you want. DVD discs allow one track of video (with multiple angles) and several tracks of audio.

Front Panel

DS9321P

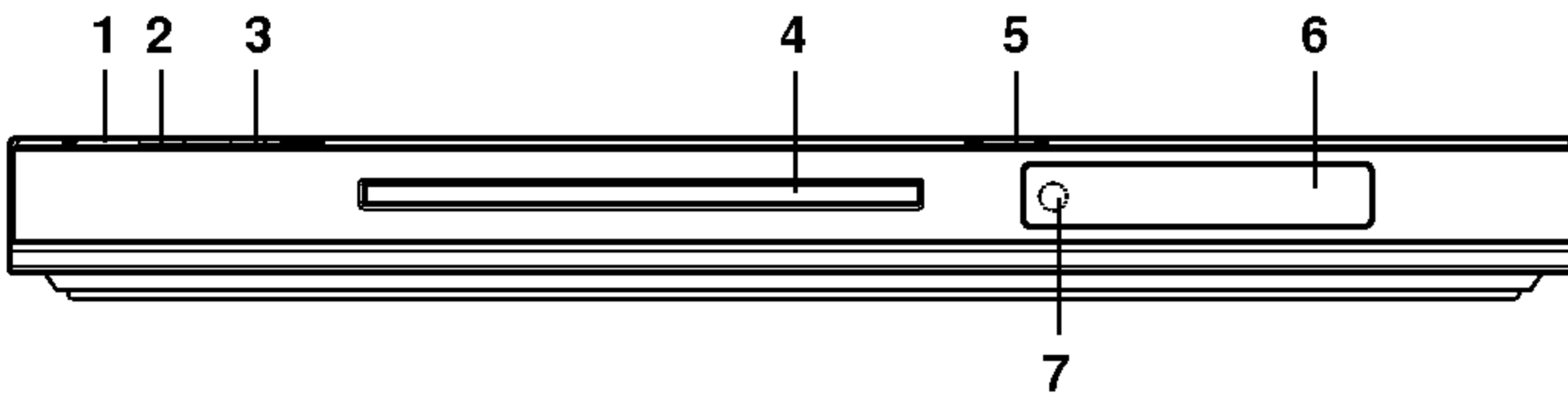

DS9521P

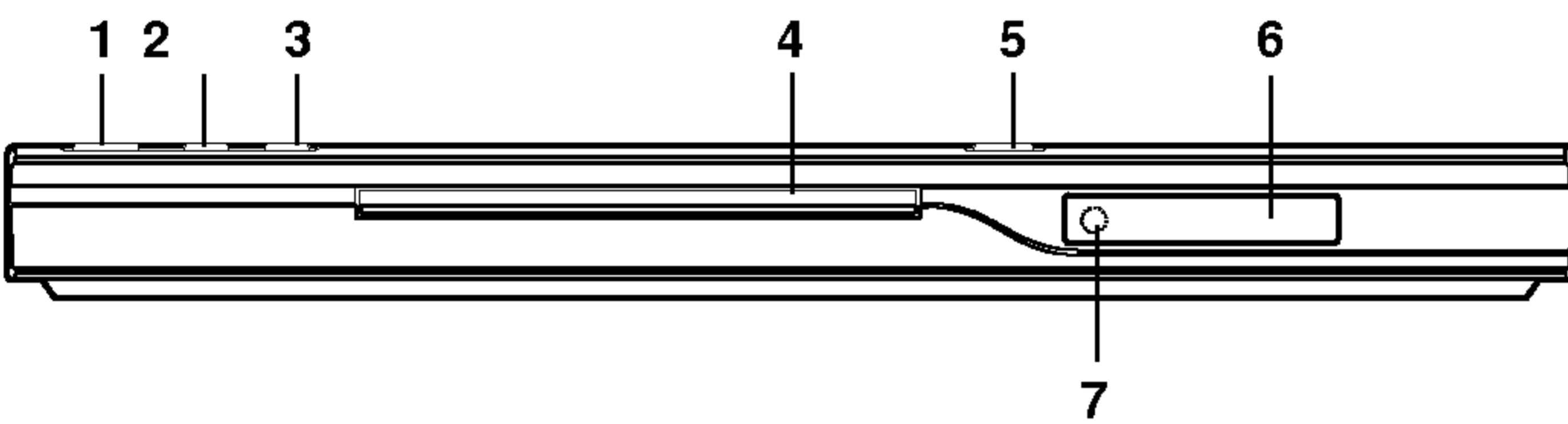

DV9721P

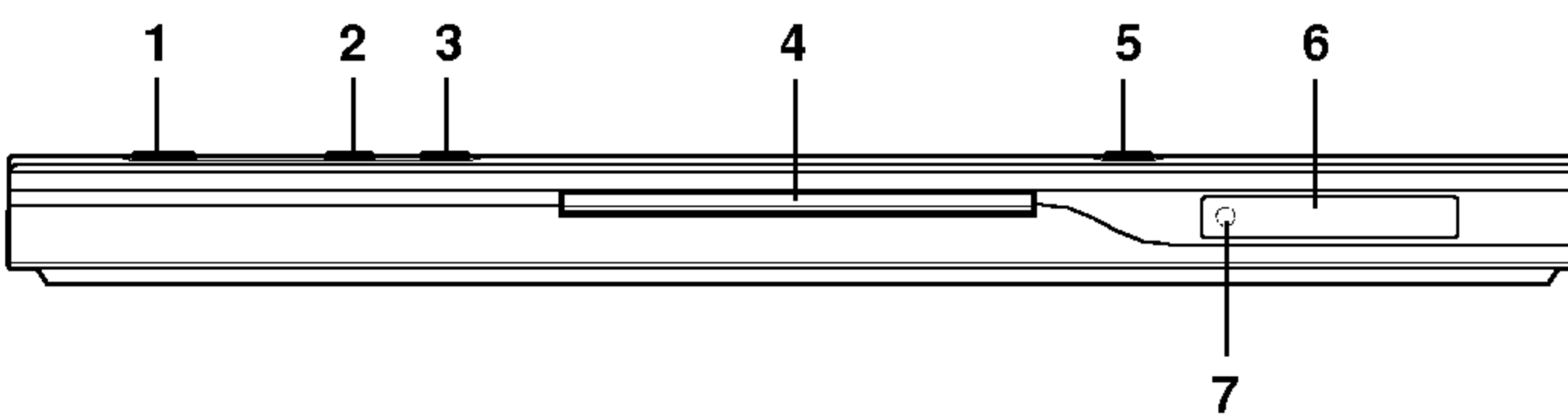

1. **POWER**
Switches the player ON and OFF.
2. **PLAY (▶)**
Starts playback.
3. **STOP (■)**
Stops playback.
4. **Disc Tray**
Insert a disc here.
5. **OPEN / CLOSE (▲)**
Opens or closes the disc tray.
6. **Display window**
Shows the current status of the player.
7. **Remote Sensor**
Point the DVD Player remote control here.

Remote Control

OPEN / CLOSE
Opens and closes the disc tray.

POWER
Switches DVD Player ON and OFF.

0-9 number buttons
Selects numbered items in a menu.

CLEAR
Removes a track number on the program list or a mark on the MARKER SEARCH menu.

SCAN (◀◀ / ▶▶)
Search backward or forward.

PAUSE / STEP (⏸)
Pauses playback temporarily/ press repeatedly for frame-by-frame playback.

PLAY (▶)
Starts playback.

DVD MENU
Accesses menu on a DVD disc.

◀▶▲▼ (left/right/up/down)
Selects an item in the menu.

ENTER
Confirms menu selection.

DISPLAY
Accesses On-Screen display.

AUDIO
Selects an audio language (DVD).

SUBTITLE
Selects a subtitle language.

ANGLE
Selects a DVD camera angle if available

SETUP
Accesses or removes setup menu.

TV Control Buttons

TV POWER:
Turns the TV on or off.

TV PR/CH +/-:
Selects TV's channel.

TV VOL +/-:
Adjusts TV's volume.

AV:
Selects the TV's source.

SKIP (◀◀ / ▶▶)
Go to next chapter or track.
Returns to beginning of current chapter or track or go to previous chapter or track.

STOP (■)
Stops playback.

TITLE
Displays title menu, if available.

RETURN
Removes the setup menu, displays the video CD with PBC.

- **MARKER**
Marks any point during playback.
- **SEARCH**
Displays MARKER SEARCH menu.
- **PROGRAM**
Places a track on the program list.
- **ZOOM**
Enlarges video image.
- **REPEAT**
Repeat chapter, track, title all.
- **A-B**
Repeat sequence.
- **RANDOM**
Plays tracks in random order.
- * This button is not available.

Remote Control Operation

Point the remote control at the remote sensor and press the buttons.



Do not mix old and new batteries and never mix different types of batteries such as standard, alkaline, etc.

Remote Control Battery installation

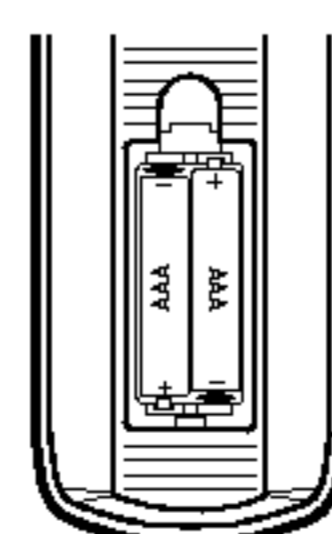

Detach the battery cover on the rear of the remote control, and insert two batteries (size AAA) with **+** and **-** aligned correctly.

Installation and Setup

Setting up the Player

The picture and sound of a nearby TV, VCR, or radio may be distorted during playback. If this occurs, position the player away from the TV, VCR, or radio, or turn off the unit after removing the disc.

DVD Player Connections

Depending on your TV and other equipment there are various ways you can connect the player. Please refer to the manuals of your TV, stereo system or other devices as necessary for additional connection information.

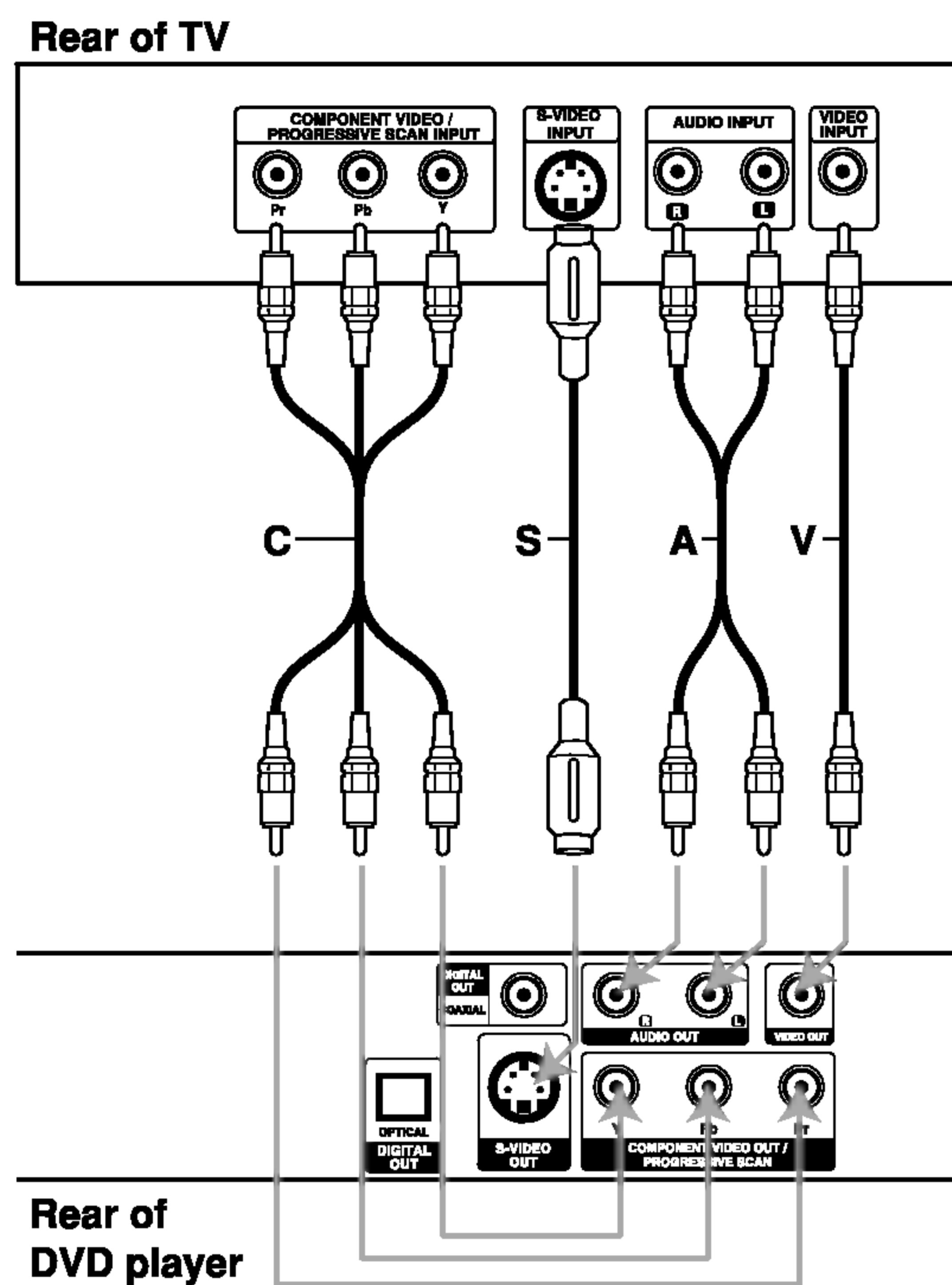

Video and Audio Connections to Your TV

Make sure the DVD player is connected directly to the TV and not to a VCR, otherwise the DVD image could be distorted by the copy protection system.

Video: Connect the VIDEO OUT jack on the DVD player to the video in jack on the TV using the video cable (V).

S-Video: Connect the S-VIDEO OUT jack on the DVD Player to the S-Video in jack on the TV using the S-Video cable (S).

Component Video (Color Stream®): Connect the COMPONENT VIDEO OUT/PROGRESSIVE SCAN jacks on the DVD Player to the corresponding in jacks on the TV using an Y Pb Pr cable (C).

Progressive Scan (ColorStream® pro):

- If your television is a high-definition or “digital ready” television, you may take advantage of the DVD Player’s progressive scan output for the highest video resolution possible.
- If your TV does not accept the Progressive Scan format, the picture will appear scrambled if you try Progressive Scan on the DVD Player.

Notes:

- Set the Progressive to “On” on the setup menu for progressive signal, see page 13.
- Set the progressive to “Off” by removing any disc from the unit and close the disc tray. see that “no disc” is displayed on the display window. Then press STOP and hold it for five seconds before releasing it.
- Progressive scan does not work with the analog video connections (yellow VIDEO OUT jack).

Audio Connection to Your TV:

Connect the left and right AUDIO OUT jacks of the DVD Player to the audio left and right IN jacks on the TV (A) using the audio cables. Do not connect the DVD Player’s AUDIO OUT jack to the phono in jack (record deck) of your audio system.

Audio Connection to Optional Equipment

Connect the DVD player to your optional equipment for audio output.

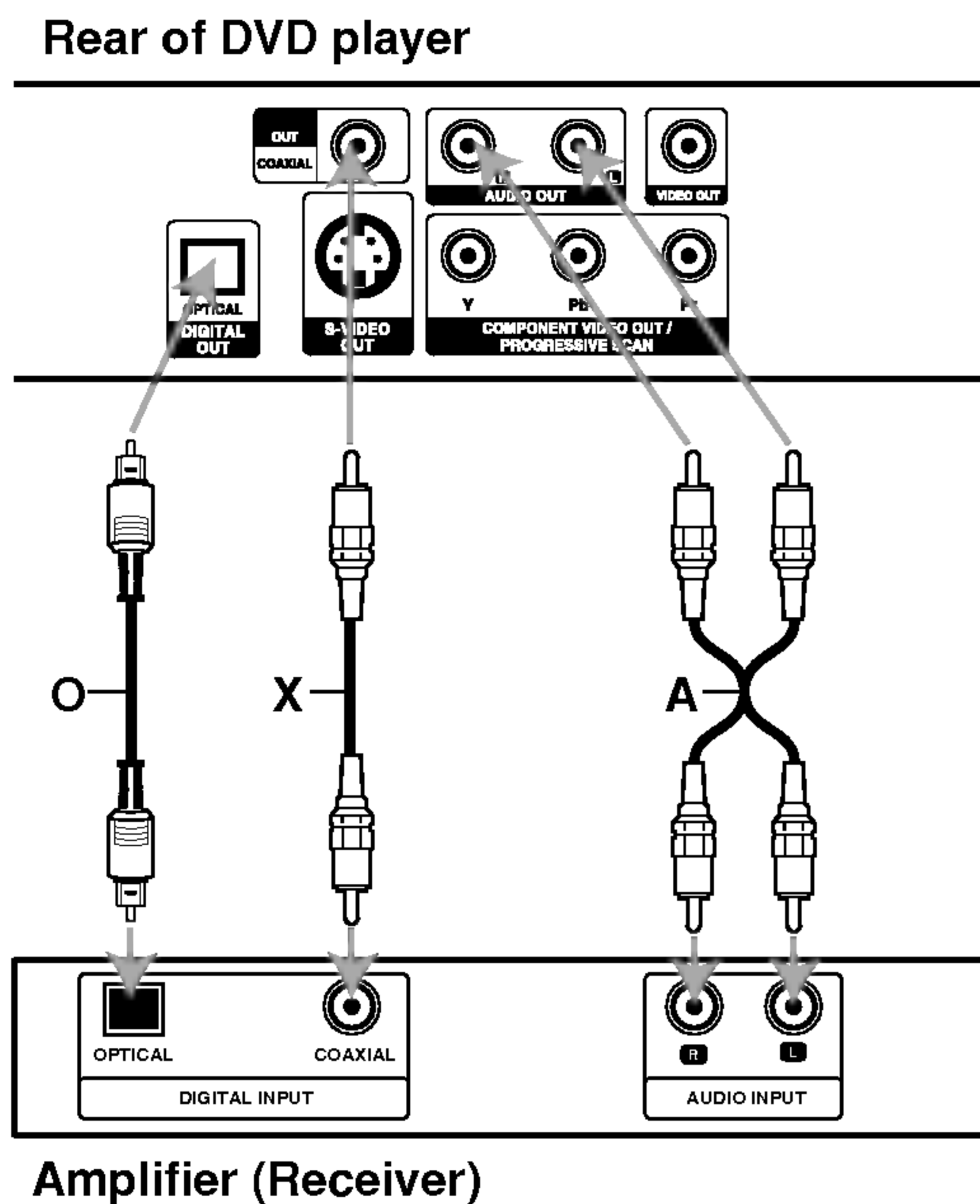

Amplifier equipped with 2-channel analog stereo or Dolby Pro Logic II / Pro Logic: Connect the left and right AUDIO OUT jacks on the DVD player to the audio left and right IN jacks on your amplifier, receiver, or stereo system, using the audio cables (A).

Amplifier equipped with 2-channel digital stereo (PCM) or audio / video receiver equipped with a multi-channel decoder (Dolby Digital™, MPEG 2, or DTS): Connect one of the DVD Player's DIGITAL AUDIO OUT jacks (OPTICAL O or COAXIAL X) to the corresponding in jack on your amplifier. Use an optional digital (optical O or coaxial X) audio cable.

Digital Multi-channel sound

A digital multi-channel connection provides the best sound quality. For this you need a multi-channel audio / video receiver that supports one or more of the audio formats supported by your DVD player such as MPEG 2, Dolby Digital and DTS. Check the receiver manual and the logos on the front of the receiver.

Notes:

- If the audio format of the digital output does not match the capabilities of your receiver, the receiver produces a strong, distorted sound or no sound at all.
- Six Channel Digital Surround Sound via a digital connection can only be obtained if your receiver is equipped with a Digital Multi-channel decoder.
- To see the audio format of the current DVD in the on-screen display, press AUDIO.

On-Screen Display





You can display the general playback status on the TV screen. Some items can be changed using the menu. To use the on-screen display:

1. Press DISPLAY during playback.
2. Press ▲ / ▼ to select an item. The selected item is highlighted.
3. Press ◀ / ▶ to change the setting. You can also use the number buttons if appropriate (e.g. inputting the title number). For some functions, press ENTER to execute the setting.



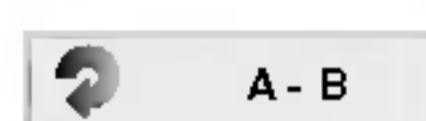
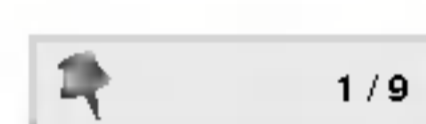

Notes:

- Some discs may not provide all of the features shown below.
- If no button is pressed for 10 seconds, the on-screen display disappears.

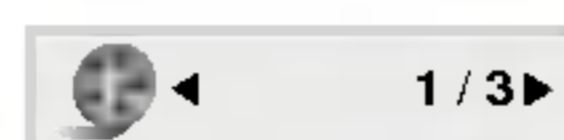
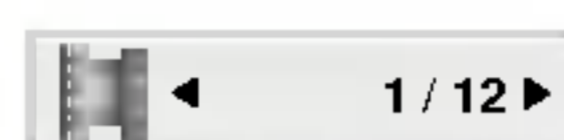
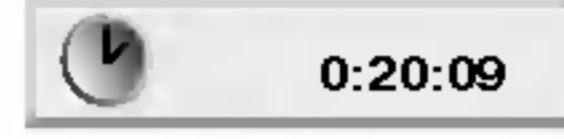

Playback Status/Restrictions

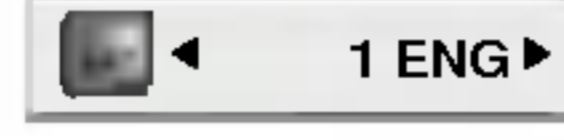
-  Title Repeat title
-  A - B Repeat sequence
-  1 / 9 Enter a Marker
-  MARKER SEARCH Marker Search menu
-  Resume play from this point
-  Action prohibited or not available

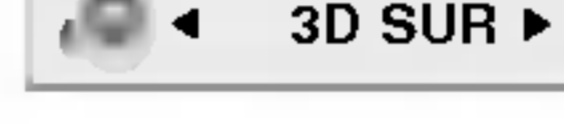
Example: On-Screen Display during playing DVD Video

Items	Selection Method
Title Number 	◀ / ▶, Numbers ENTER
Chapter Number 	◀ / ▶, Numbers ENTER
Time search 	Numbers, ENTER
Audio language and Digital Audio Output mode 	◀ / ▶ or AUDIO
Subtitle language 	◀ / ▶ or SUBTITLE
Angle 	◀ / ▶ or ANGLE
Sound 	◀ / ▶

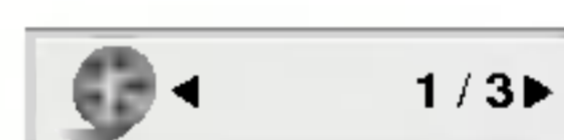
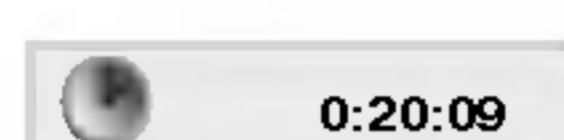
Example: On-Screen Display during playing VCD

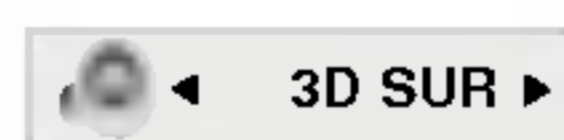
Items	Selection Method
Track Number (or PBC mode) 	◀ / ▶, Numbers ENTER
Time search 	Numbers ENTER
Audio Channel 	◀ / ▶ or AUDIO
Sound 	◀ / ▶

Initial Settings

By using the Setup menu, you can make various adjustments to items such as picture and sound. You can also set a language for the subtitles and the Setup menu, among other things. For details on each Setup menu item, see pages 12 to 15.

To display and exit the Menu:

Press SETUP to display the menu. A second press of SETUP will take you back to initial screen.

To go to the next level:

Press ► on the remote control.

To go back to the previous level:

Press ◀ on the remote control.

General Operation

1. Press SETUP. The Setup menu appears.
2. Use ▲ / ▼ to select the desired option then press ► to move to the second level. The screen shows the current setting for the selected item, as well as alternate setting(s).
3. Use ▲ / ▼ to select the second desired option then press ► to move to the third level.
4. Use ▲ / ▼ to select the desired setting then press ENTER to confirm your selection. Some items require additional steps.
5. Press SETUP or PLAY to exit the Setup menu.

LANGUAGE



Menu Language

Select a language for the Setup menu and on-screen display.

Disc Audio / Subtitle / Menu **DVD**

Select the language you prefer for the audio track (disc audio), subtitles, and the disc menu.

Original: Refers to the original language in which the disc was recorded.

Other: To select another language, press number buttons then ENTER to enter the corresponding 4-digit number according to the language code list in the reference chapter. If you enter the wrong language code, press CLEAR.

DISPLAY



TV Aspect **DVD**

4:3: Select when a standard 4:3 TV is connected.

16:9 Wide: Select when a 16:9 wide TV is connected.

Display Mode **DVD**

Display Mode setting works only when the TV Aspect mode is set to "4:3".

Letterbox: Displays a wide picture with bands on the upper and lower portions of the screen.

Panscan: Automatically displays the wide picture on the entire screen and cuts off the portions that do not fit.

Progressive Scan

Progressive Scan Video provides the highest quality pictures with less flickering.

If you are using the Component Video jacks for connection to a TV or monitor that is compatible with a progressive scan signal, set Progressive Scan to On.

To Turn ON progressive scan:

Connect component out of the DVD to the input of your monitor/television, set your television or monitor to Component Input.

1. Select "Progressive Scan" on the DISPLAY menu then press ►.



2. Select "On" using the ▲ / ▼ buttons.
3. Press ENTER to confirm your selection. The confirm menu will appear.

Note:

If your TV does not accept the Progressive Scan format, the picture will appear scrambled if you try Progressive Scan on the DVD Player.

4. When the confirm menu appears on your screen Cancel is highlighted as default. Use the ◀ / ▶ buttons to highlight Enter.
5. Pressing ENTER will set the player to Progressive scan mode.

Caution:

Once the setting for progressive scan output is entered, an image will only be visible on a progressive scan compatible TV or monitor. If you set Progressive Scan to On in error, you must reset the unit. First, remove the disc in the DVD Player. Next, press STOP (■) and hold it for five seconds before releasing it. The video output will be restored to the standard setting, and a picture will once again be visible on a conventional analog TV or monitor.

AUDIO

Each DVD disc has a variety of audio output options. Set the player's AUDIO options according to the type of audio system you use.



Dolby Digital / DTS / MPEG **DVD**

Bitstream: Select "Bitstream" if you connect the DVD Player's DIGITAL OUT jack to an amplifier or other equipment with a Dolby Digital, DTS or MPEG decoder.

PCM (for Dolby Digital / MPEG): Select when connected to a two-channel digital stereo amplifier. DVDs encoded in Dolby Digital or MPEG will be automatically downmixed to two-channel PCM audio.

Off (for DTS): If you select "Off", the DTS signal is not output through the DIGITAL OUT jack.

Sample Freq. (Frequency) **DVD**

If your receiver or amplifier is NOT capable of handling 96 kHz signals, select 48 kHz. When this choice is made, this unit automatically converts any 96 kHz signals to 48 kHz so your system can decode them.

If your receiver or amplifier is capable of handling 96 kHz signals, select 96 kHz. When this choice is made, this unit passes each type of signal through without any further processing.

Check the documentation for your amplifier to verify its capabilities.

Dynamic Range Control (DRC) **DVD**

With the DVD format, you can hear a program's soundtrack in the most accurate and realistic presentation possible, thanks to digital audio technology. However, you may wish to compress the dynamic range of the audio output (the difference between the loudest sounds and the quietest ones). This allows you to listen to a movie at a lower volume without losing clarity of sound. Set DRC to On for this effect.

Vocal **DVD**

Set to On only when a multi-channel karaoke DVD is playing. The karaoke channels on the disc mix into normal stereo sound.

OTHERS

The PBC, Auto Play and B.L.E. settings can be changed.



PBC **VCD**

Set Playback Control (PBC) to On or Off.

On: Video CDs with PBC are played according to the PBC.

Off: Video CDs with PBC are played the same way as Audio CDs.

Auto Play **DVD**

You can set up the DVD Player so a DVD disc automatically starts playing whenever the DVD is inserted.

If Auto Play mode is set to On, this DVD player will search for title that has the longest playback time and then play back the title automatically.

On: Auto Play function is active.

Off: Auto Play function is not active.

Note:

The Auto Play function may not work for some DVDs.

B.L.E. (Black Level Expansion)

To select the black level of playback pictures. Set your preference and monitor's ability.

On: Expanded grey scale. (0 IRE cut off)

Off: Standard grey scale. (7.5 IRE cut off)

Note:

The B.L.E. function works NTSC system only.

LOCK (Parental Control)



Rating **DVD**

Some movies contain scenes that may not be suitable for children to view. Many of these discs contain parental control information that applies to the complete disc or to certain scenes on the disc. Movies and scenes are rated from 1 to 8, depending on the country. Some discs offer more suitable scenes as an alternative.

The parental control feature allows you to block access to scenes below the rating you input, thereby preventing your children from being able to view material you believe is unsuitable.

1. Select "Rating" on the LOCK menu then press ►.
2. To access the Rating, Password and Area Code features, you must input the 4-digit security code you created. If you have not yet entered a security code you are prompted to do so.

Input a 4-digit code and press ENTER. Enter it again and press ENTER to verify. If you make a mistake before pressing ENTER, press CLEAR.

3. Select a rating from 1 to 8 using the ▲ / ▼ buttons.

Rating 1-8: Rating one (1) has the most restrictions and rating eight (8) is the least restrictive.

Unlock

If you select unlock, parental control is not active and the disc plays in full.

Note:

If you set a rating for the player, all disc scenes with the same rating or lower are played. Higher rated scenes are not played unless an alternate scene is available on the disc. The alternative must have the same rating or a lower one. If no suitable alternative is found, playback stops. You must enter the 4-digit password or change the rating level in order to play the disc.

4. Press ENTER to confirm your rating selection, then press SETUP to exit the menu.

Password (Security Code)

You can enter or change password.

1. Select Password on the LOCK menu then press ►.
2. Follow step 2 as shown left (Rating). "Change" or "New" is highlighted.
3. Enter the new 4-digit code, then press ENTER. Input it again to verify.
4. Press SETUP to exit the menu.

If you forget your Security Code

If you forget your security code you can clear it using the following steps:

1. Press SETUP to display the Setup menu.
2. Input the 6-digit number "210499" and the security code is cleared.
3. Enter a new code as described above.

Area Code **DVD**

Enter the code of the area whose standards were used to rate the DVD video disc, based on the list in the reference chapter.

1. Select "Area Code" on the LOCK menu then press ►.
2. Follow step 2 as shown left (Rating).
3. Select the first character using ▲ / ▼ buttons.
4. Press ENTER and select the second character using ▲ / ▼ buttons.
5. Press ENTER to confirm your area code selection.

Operation

Playing a DVD or Video CD

Playback Setup

1. Turn on the TV and select the video input source connected to the DVD player.
2. Turn on the audio system (if applicable) and select the input source connected to the DVD player.
3. Press OPEN/CLOSE to open the disc tray and load your chosen disc in the tray, with the playback side down.
4. Press OPEN/CLOSE to close the tray. Press PLAY.

In some cases, the disc menu might appear instead:

DVD

Use the ◀ ▶ ▲ ▼ buttons to select the title/chapter you want to view, then press ENTER to start. Press TITLE or DVD MENU to return to the menu screen.

VCD

Use the number buttons to select the track you want to view and press RETURN to return to the menu screen. Menu settings and operating procedures may differ. Follow the instructions on the each menu screen. You also may set PBC to Off (See "PBC" on page 14).

Notes:

- If parental control is set and the disc is not within the rating settings you must input the password. (See "Lock Menu" on page 15.)
- DVDs may have a region code. Your player does not play discs that have a region code different from your player. The region code for this player is 3 (three).

General Features

Note:

Unless stated otherwise, all operations described use the remote control. Some features may also be available on the Setup menu.

Moving to another TITLE **DVD**

When a disc has more than one title, you can move to another title. Press DISPLAY while playback is stopped then the appropriate number (0-9) or use ◀ / ▶ to move to another title.

You can play any title by inputting its number while playback is stopped.

Moving to another CHAPTER/TRACK

DVD VCD

When a title on a disc has more than one chapter or a disc has more than one track, you can move to another chapter/track as follows:

- Press SKIP ◀◀ or ▶▶ briefly during playback to select the next chapter/track or to return to the beginning of the current chapter/track.
- Press SKIP ◀◀ twice briefly to step back to the previous chapter/track.
- To go directly to any chapter during DVD playback, press DISPLAY and press ▲ / ▼ to select the chapter/track icon. Then, input the chapter/track number or use ◀ / ▶.

Search **DVD VCD**

1. Press SCAN (◀◀ or ▶▶) during playback.
2. Press SCAN (◀◀ or ▶▶) repeatedly to select the required speed.
DVD; X2, X4, X16 or X100
Video CD; X2, X4 or X8
3. To exit SEARCH mode, press PLAY.

Changing the Audio Channel **VCD**

Press AUDIO repeatedly during playback to hear a different audio channel (Stereo, Left, or Right).

Still Picture and Frame-by-Frame Playback

DVD VCD

1. Press PAUSE/STEP on the remote control during playback. Advance the picture frame-by-frame by pressing PAUSE/STEP repeatedly.
2. To exit still motion mode, press PLAY.

Slow Motion **DVD VCD**

1. Press PAUSE/STEP (II) during playback.
The DVD player will now go into PAUSE mode.
2. Use the SCAN (◀◀ or ▶▶) to select the required speed: ◀◀ 1/16, ◀◀ 1/8, ◀◀ 1/4, or ◀◀ 1/2 (backward), or ▶▶ 1/16, ▶▶ 1/8, ▶▶ 1/4, or ▶▶ 1/2 (forward).

With a Video CD, the Slow speed changes: ▶▶ 1/16, ▶▶ 1/8, ▶▶ 1/4 or ▶▶ 1/2 (forward).

3. To exit Slow Motion mode, press PLAY (▶).

Note:

Slow motion playback in reverse is not possible with Video CDs.

Random **VCD Karaoke DVD**

1. Press RANDOM during playback. The unit automatically begins random playback and RANDOM appears on the TV screen.
2. Press RANDOM again to normal.

Tip:

By pressing SKIP ▶▶I during random playback, the unit selects another title (track) and resumes random playback.

Note:

On a Video CD with PBC, You must set PBC to Off on the setup menu to use the random function (See "PBC" on page 14).

Repeat A-B **DVD VCD**

To repeat a sequence.

1. Press A-B at your chosen starting point. "A * " appears briefly on the TV screen.
2. Press A-B again at your chosen end point. "A B" appears briefly on the TV screen and the repeat sequence begins.
3. Press A-B again to cancel.

Repeat **DVD VCD1.1**

You can play a title/chapter/all/track on a disc. Press REPEAT during playback to select a desired repeat mode.

DVD Video Discs - Repeat Chapter/Title/Off

- Chapter: repeats the current chapter.
- Title: repeats the current title.
- Off : does not play repeatedly.

Video CDs - Repeat Track/All/Off

- Track : repeats the current track
- All : repeats all the tracks on a disc.
- Off : does not play repeatedly.

Notes:

- On a Video CD with PBC, you must set PBC to Off on the setup menu to use the repeat function (See "PBC" on page 14).
- If you press SKIP (▶▶I) once during Repeat Chapter (Track) playback, the repeat playback cancels.

3D Surround **DVD VCD**

To produce a 3D surround effect that simulates multi-channel audio from two stereo speakers (instead of the five+ speakers normally required for multi-channel audio from a home theater system).

1. Press DISPLAY during playback.
2. Use ▲ or ▼ to select the sound option.
The sound option will be highlighted.
3. Use ◀ or ▶ to to select "3D SUR".
To turn off the 3D Surround effect, select "Normal".

Time Search **DVD VCD**

To start playing at any chosen time on the disc:

1. Press DISPLAY during playback. The time search box shows the elapsed playing time.
2. Press ▲ / ▼ to select the time clock icon and "-:--:--" appears.
3. Input the required start time in hours, minutes, and seconds from left to right. If you enter the wrong numbers, press CLEAR to remove the numbers you entered. Then input the correct numbers.
4. Press ENTER to confirm. Playback starts from the selected time.

Zoom **DVD** **VCD**

Use zoom to enlarge the video image.

1. Press ZOOM during playback or still playback to activate the Zoom function. The square frame appears briefly in the right bottom of the picture.
2. Each press of the ZOOM button changes the TV screen in the sequence: 100% size → 400% size → 1600% size → screen fit mode → 100% size

Screen fit mode:

You can change the way the image appears on the screen when you're playing a DVD movie. Press ▲/▼ to select between Normal, Enhanced, and Maximum.

3. Use the ◀▶▲▼ buttons to move through the zoomed picture.
4. To resume normal playback, press CLEAR.

Notes:

- Zoom may not work on some DVDs.
- Screen fit mode is available for playing the DVD disc and movie file.

Marker Search **DVD** **VCD**

To enter a Marker

You can start playback from up to nine memorized points. To enter a marker, press MARKER at the desired point on the disc. The Marker icon appears on the TV screen briefly. Repeat to enter up to nine markers.

To Recall or Clear a Marked Scene

1. During disc playback, press SEARCH. The marker search menu appears on the screen.
2. Within 10 seconds, press ◀/▶ to select a marker number that you want to recall or clear.
3. Press ENTER and playback starts from the marked scene. Or, Press CLEAR and the marker number is erased from the list.
4. You can play any marker by inputting its number on the marker search menu.

Special DVD Features

Checking the contents of DVD discs: Menus

DVDs may offer menus that allow you to access special features. To use the disc menu, press DVD MENU. Input the corresponding number or use the ◀▶▲▼ buttons to highlight your selection. Then press ENTER.

Title Menu **DVD**

1. Press TITLE. If the current title has a menu, the menu appears on the screen. Otherwise, the disc menu may appear.
2. The menu offers features such as camera angles, spoken language and subtitle options, and chapters for the title.
3. Press TITLE to exit.

Disc Menu **DVD**

Press DVD MENU and the disc menu is displayed. Press DVD MENU again to exit.

Camera Angle **DVD**

If the disc contains scenes recorded at different camera angles, you can change to a different camera angle during playback. Press ANGLE repeatedly during playback to select a desired angle. Note that the number of the current angle appears on the display.

Tip:

The angle indicator will blink on the TV screen during scenes recorded at different angles as an indication that angle switching is possible.

Changing the Audio Language **DVD**

Press AUDIO repeatedly during playback to hear a different audio language or audio track.

Subtitles **DVD**

Press SUBTITLE repeatedly during playback to see the different subtitle languages.

Playing an Audio CD or MP3/WMA Disc

The DVD player can play MP3/WMA formatted recordings on CD-ROM, CD-R, or CD-RW discs.

Audio CD

Once you insert an audio CD a menu appears on the TV screen. Press ▲ / ▼ to select a track then press PLAY or ENTER and playback starts.



MP3 / WMA

1. Press ▲ / ▼ to select a folder, and press ENTER to see the folder contents.
2. Press ▲ / ▼ to select a track then press PLAY or ENTER. Playback starts.



ID3 TAG

- When playing a file containing information such as track titles, you can see the information by pressing DISPLAY.
[Title, Artist, Album, Year, Comment]
- If there is no information, "NO ID3 TAG" appear on the display.

Tips:

- If you are in a file list on the MUSIC menu and want to return to the Folder list, use the ▲ / ▼ to highlight  and press ENTER.
- Press DVD MENU to move to the next page.
- On a CD with MP3/WMA and JPEG you can switch MP3/WMA and JPEG. Press TITLE and MUSIC or PHOTO word on top of the menu is highlighted.

MP3 / WMA disc compatibility with this player is limited as follows:

- Sampling frequency: within 8 - 48 kHz (MP3), within 32 - 48kHz (WMA)
- Bit rate: within 8 - 320kbps (MP3), 32 - 192kbps (WMA)
- The player cannot read an MP3/WMA file that has a file extension other than ".mp3" / ".wma".
- CD-R physical format should be ISO 9660
- If you record MP3 / WMA files using software that cannot create a file system (eg. Direct-CD) it is impossible to playback MP3 / WMA files. We recommend that you use Easy-CD Creator, which creates an ISO 9660 file system.
- File names should have a maximum of 8 letters and must incorporate an .mp3 or .wma extension.
- They should not contain special letters such as / ? * : " < > | etc.
- The total number of files on the disc should be less than 650.

This DVD player requires discs and recordings to meet certain technical standards in order to achieve optimal playback quality. Pre-recorded DVDs are automatically set to these standards. There are many different types of recordable disc formats (including CD-R containing MP3 or WMA files) and these require certain pre-existing conditions (see above) to ensure compatible playback.

Customers should note that permission is required in order to download MP3 / WMA files and music from the Internet. Our company has no right to grant such permission. Permission should always be sought from the copyright owner.

Audio CD and MP3 / WMA Disc Features

Pause **CD** **MP3** **WMA**

1. Press PAUSE/STEP during playback.
2. To return to playback, press PLAY, ENTER or press PAUSE/STEP again.

Moving to another Track **CD** **MP3** **WMA**

1. Press SKIP (I◀◀ or ▶▶I) briefly during playback to go to the next track or to return to the beginning of the current track.
2. Press SKIP I◀◀ twice briefly to go back to the previous track.
3. You can play any track by inputting its number.

Repeat Track/All/Off **CD** **MP3** **WMA**

You can play a track/all on a disc.

1. Press REPEAT when playing a disc. The repeat icon appears.
2. Press REPEAT to select a desired repeat mode.
 - Track: repeats the current track
 - All: repeats all the tracks on a disc.
 - Off(No display): does not play repeatedly.

Note:

If you press SKIP (▶▶I) once during Repeat Track playback, the repeat playback cancels.

Search **CD** **MP3** **WMA**

1. Press SCAN (◀◀ or ▶▶) during playback.
2. Press SCAN (◀◀ or ▶▶) repeatedly to select the required speed: X2, X4, X8 backward or forward.
3. To exit SEARCH mode, press PLAY.

Random **CD** **MP3** **WMA**

1. Press RANDOM during playback. Random Playback begins immediately and RANDOM appears on the menu screen.
2. To return to normal playback, press RANDOM repeatedly until RANDOM disappears from the menu screen.

Tip:

By pressing SKIP ▶▶I during random playback, the unit selects another track and resumes random playback.

Repeat A-B **CD**

1. To repeat a sequence during disc playback press A-B at your chosen starting point. The Repeat icon and "A" appear on the menu screen.
2. Press A-B again at your chosen end point. The Repeat icon and "A-B" appear on the menu screen, and the sequence begins to play repeatedly.
3. To exit the sequence and return to normal play, press A-B again. The Repeat icon disappears from the menu screen.

3D Surround **CD**

To produce a 3D surround effect that simulates multi-channel audio from two stereo speakers (instead of the five+ speakers normally required for multi-channel audio from a home theater system).

1. Press AUDIO during playback. "3D SUR." appears on the menu screen.
2. To return to normal playback, press AUDIO repeatedly until "3D SUR." disappears from the menu screen.

Programmed Playback

The program function enables you to store your favorite tracks from any disc in the player memory. A program can contain 30 tracks.

1. Insert a disc.

Audio CD or MP3/WMA Discs:

AUDIO CD or MUSIC menu appears.

2. Press PROGRAM

The  mark will appear to the right of the word "Program" on the right side of the menu screen.

Note:

Press PROGRAM again, then the  mark will disappear to exit the Program Edit mode.



Audio CD Menu

MP3/WMA Menu

Video CD: Press PROGRAM. while playback is stopped. The program menu appears. Press PROGRAM again and hold it down for a few seconds to exit the menu.

Note:

On a Video CD with PBC, you must set PBC to Off on the setup menu to use the programmed playback (See "PBC" on page 14).

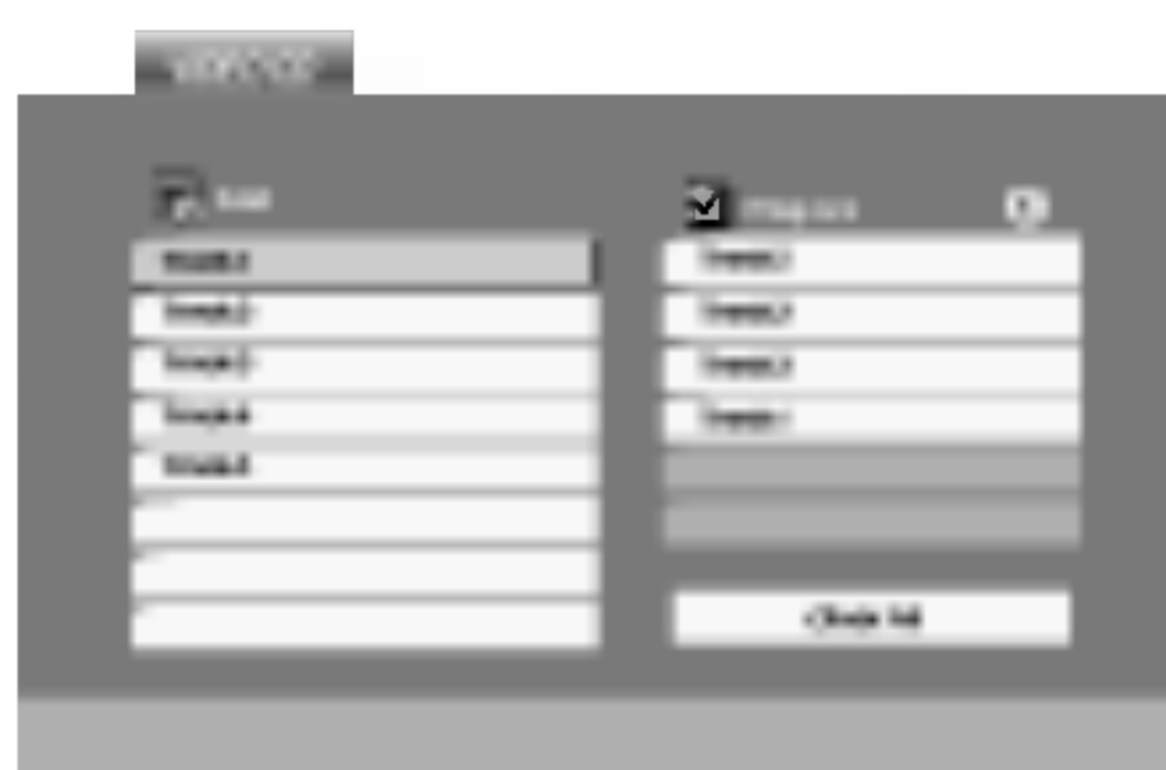

Video CD Menu

3. Select a track on the "List", then press ENTER to place the selected track on the "Program" list. Repeat to place additional tracks on the list.
4. Press . Select the track you want to start playing on the "Program" list.

5. Press PLAY or ENTER to start. Playback begins in the order in which you programmed the tracks. Playback stops after all of the tracks on the "Program" list have played once.
6. To resume normal playback from programmed playback, select a track of AUDIO CD (or MUSIC) list and then press PLAY.



Repeat Programmed Tracks

1. Press REPEAT when playing a disc. The repeat icon appears.
2. Press REPEAT to select a desired repeat mode.
 - Track: repeats the current track
 - All: repeats all the tracks on programmed list.
 - Off(No display): does not play repeatedly.



Note:

If you press  once during Repeat Track playback, the repeat playback cancels.

Erasing a Track from "Program" List

1. Use    to select the track that you wish to erase from the Program list.
2. Press CLEAR. Repeat to erase additional tracks on the list.

Erasing the Complete Program List

1. Press  to move to the "Program" list.
2. Use  /  to select "Clear All", then press ENTER.

Note:

The programs are also cleared when the disc is removed.

Viewing a JPEG Disc

Using this DVD Player you can view discs with JPEG files.

1. Insert a disc and close the tray. The PHOTO menu appears on the TV screen.

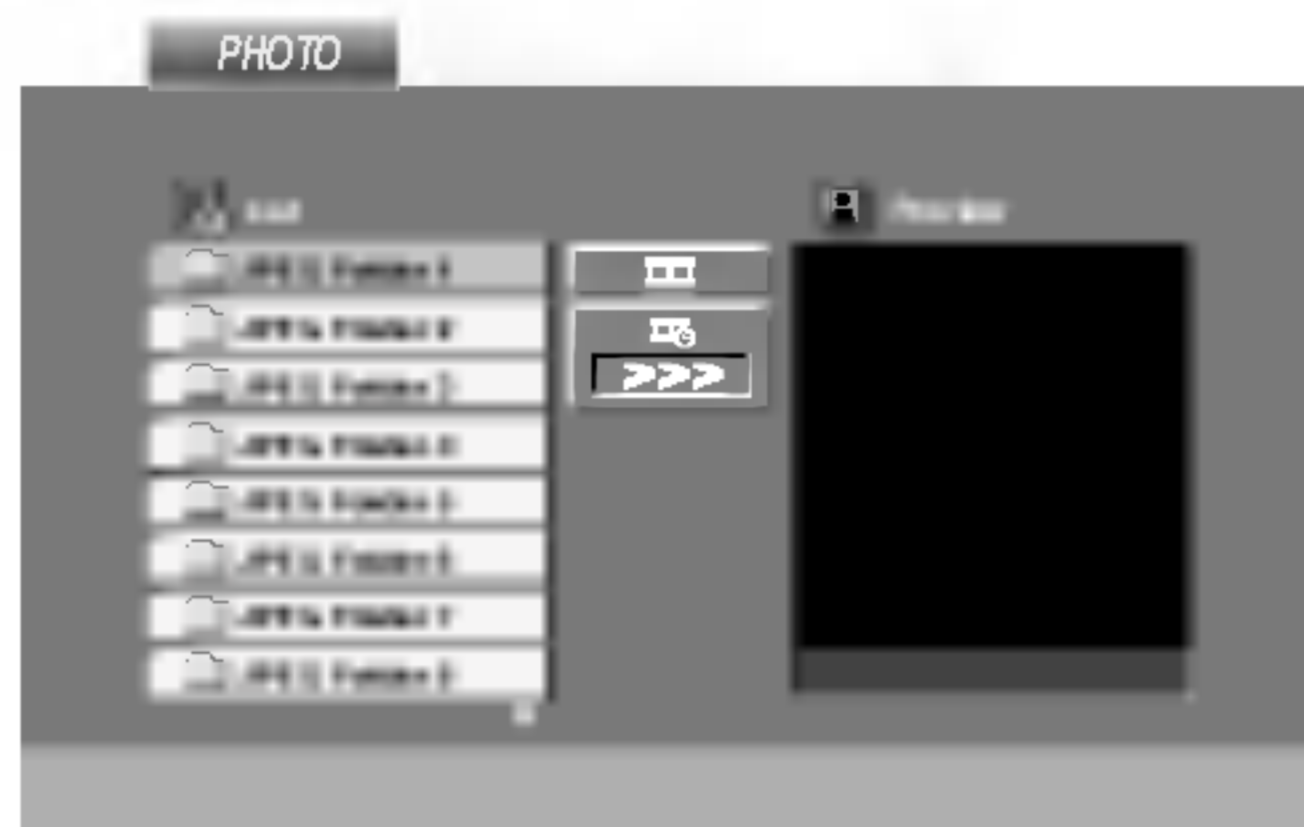

2. Press ▲ / ▼ to select a folder, and press ENTER. A list of files in the folder appears. If you are in a file list and want to return to the previous Folder list, use the ▲ / ▼ buttons on the remote to highlight and press ENTER.
3. If you want to view a particular file, press ▲ / ▼ to highlight a file and press ENTER or PLAY. Viewing the file proceeding starts. While viewing a file, you can press STOP to move to the previous menu (PHOTO menu).

Tips:

- Press DVD MENU to move to the next page.
- There are three Slide Speed options : >>> (Fast), >> (Normal) and > (Slow). Use ▲ ▼ ◀ ▶ to highlight the Speed. Then, use ◀ / ▶ to select the option you want to use then press ENTER.
- On a disc with MP3/WMA and JPEG you can switch MP3/WMA and JPEG. Press TITLE and MUSIC or PHOTO word on top of the menu is highlighted.
- Press RETURN, information of file is hidden.

Slide Show **JPEG**

Use ▲ ▼ ◀ ▶ to highlight the (Slide Show) then press ENTER.

Still Picture **JPEG**

1. Press PAUSE/STEP during slide show. The player will now go into PAUSE mode.
2. To return to the slide show, press PLAY or press PAUSE/STEP again.

Moving to another File **JPEG**

Press SKIP (◀◀ or ▶▶) or cursor (◀ or ▶) once while viewing a picture to advance to the next or previous file.

Zoom **JPEG**

Use zoom to enlarge the photo image. (see 18 page)

To rotate picture

Press ▲ / ▼ during showing a picture to rotate the picture clockwise or counter clockwise.

To listen to MP3/WMA music watching picture

JPEG

You can display files while listening to MP3/WMA music files recorded on the same disc.

1. Insert the disc containing the two types of file in the player.
2. Press TITLE to display PHOTO menu.
3. Press ▲ / ▼ to select a photo file.
4. Use ▶ to select icon then press ENTER. Playback starts. The playback will continue until STOP is pressed.

Tip:

To listen to only the desired music watching picture, programmed the desired tracks from the "MUSIC" menu and then proceed as above.

JPEG disc compatibility with this player is limited as follows:

- Depending upon the size and number of JPEG files, it could take a long time for the DVD player to read the disc's contents. If you don't see an on-screen display after several minutes, some of the files may be too large — reduce the resolution of the JPEG files to less than 2M pixels as 2760 x 2048 pixels and burn another disc.
- The total number of files and folders on the disc should be less than 650.
- Some discs may be incompatible due to a different recording format or the condition of disc.
- Ensure that all the selected files have the ".jpg" extensions when copying into the CD layout.
- If the files have ".jpe" or ".jpeg" extensions, please rename them as ".jpg" file.
- File names without ".jpg" extension will not be able to be read by this DVD player. Even though the files are shown as JPEG image files in Windows Explorer.

Maintenance and Service

Refer to the information in this chapter before contacting a service technician.

Handling the Unit

When shipping the unit

Please save the original shipping carton and packing materials. If you need to ship the unit, for maximum protection, re-pack the unit as it was originally packed at the factory.

Keeping the exterior surfaces clean

- Do not use volatile liquids such as insecticide spray near the unit.
- Do not leave rubber or plastic products in contact with the unit for a long period of time. since they leave marks on the surface.

Cleaning the unit

To clean the player, use a soft, dry cloth. If the surfaces are extremely dirty, use a soft cloth lightly moistened with a mild detergent solution.

Do not use strong solvents such as alcohol, benzine, or thinner, as these might damage the surface of the unit.

Maintaining the Unit

The DVD player is a high-tech, precision device. If the optical pick-up lens and disc drive parts are dirty or worn, the picture quality could be diminished.

Depending on the operating environment, regular inspection and maintenance are recommended after every 1,000 hours of use.

For details, please contact your nearest authorized service center.

Additional Features

Last Scene Memory

DVD **CD** **VCD1.1**

This player memorizes last scene from the last disc that is viewed. The last scene remains in memory even if you remove the disc from the player or switch off the player. If you load a disc that has the scene memorized, the scene is automatically recalled.

Note:

This player does not memorize the scene of a disc if you switch off the player before commencing to play the disc.

Screen Saver

The screen saver appears when you leave the DVD player in Stop mode for about five minutes. If the Screen Saver is displayed for five minutes, the DVD Player automatically turns itself off.

Video Mode Setting

- With certain discs, the playback picture may be flickering or Dot Crawl is shown on straight lines. That means Vertical interpolation or De-interlace is not perfectly matched with the disc. In this case, the picture quality may be improved by changing the video mode.
- To change the video mode, press and hold DISPLAY about 3 seconds during disc playback. The new video mode number selected is displayed on the TV screen. Check whether the video quality has improved. If not, repeat the above procedure until picture quality is improved.
- Video mode change sequence:
MODE1 → MODE2 → MODE3 → MODE1
- If you turn off the power, the video mode will be back to initial state (MODE1).

Tip:

Detailed Descriptions for Video Modes

MODE1: The source material of the DVD video (film material or video material) is determined from disc information.

MODE2: Suitable for playing film based content or video based material recorded by the progressive scan method.

MODE3: Suitable for playing video based content with comparatively little motion.

Note:

The video mode setting only works when the Progressive Scan mode is set to "On" in the Setup menu.

Controlling other TVs with the remote control

You can control the sound level, input source, and power switch of your LG TV with the supplied remote control.

You can control the sound level, input source, and power switch of non-LG TVs as well. If your TV is listed in the table below, set the appropriate manufacturer code.

1. While holding down TV POWER button, press the number buttons to select the manufacturer code for your TV (see the table below).
2. Release TV POWER button.

Code numbers of controllable TVs

If more than one code number is listed, try entering them one at a time until you find the one that works with your TV.

Manufacturer	Code Number
LG / GoldStar	1 (Default), 2
Zenith	1, 3, 4
Samsung	6, 7
Sony	8, 9
Hitachi	4

Notes:

- Depending on your TV, some or all buttons may not function on the TV, even after entering the correct manufacturer code.
- If you enter a new code number, the code number previously entered will be erased.
- When you replace the batteries of the remote, the code number you have set may be reset to the default setting. Set the appropriate code number again.

System Select

You must select the appropriate system mode for your TV system. If NO DISC appears in the display window, press and hold PAUSE/STEP for more than 5 seconds to be able to select a system (PAL, NTSC, or AUTO).

Reference

Language Codes

Use this list to input your desired language for the following initial settings:
Disc Audio, Disc Subtitle, Disc Menu.

Language	Code	Language	Code	Language	Code	Language	Code
Abkhazian	6566	Fiji	7074	Lingala	7678	Singhalese	8373
Afar	6565	Finnish	7073	Lithuanian	7684	Slovak	8375
Afrikaans	6570	French	7082	Macedonian	7775	Slovenian	8376
Albanian	8381	Frisian	7089	Malagasy	7771	Somali	8379
Ameharic	6577	Galician	7176	Malay	7783	Spanish	6983
Arabic	6582	Georgian	7565	Malayalam	7776	Sudanese	8385
Armenian	7289	German	6869	Maltese	7784	Swahili	8387
Assamese	6583	Greek	6976	Maori	7773	Swedish	8386
Aymara	6588	Greenlandic	7576	Marathi	7782	Tagalog	8476
Azerbaijani	6590	Guarani	7178	Moldavian	7779	Tajik	8471
Bashkir	6665	Gujarati	7185	Mongolian	7778	Tamil	8465
Basque	6985	Hausa	7265	Nauru	7865	Tatar	8484
Bengali; Bangla	6678	Hebrew	7387	Nepali	7869	Telugu	8469
Bhutani	6890	Hindi	7273	Norwegian	7879	Thai	8472
Bihari	6672	Hungarian	7285	Oriya	7982	Tibetan	6679
Breton	6682	Icelandic	7383	Panjabi	8065	Tigrinya	8473
Bulgarian	6671	Indonesian	7378	Pashto, Pushto	8083	Tonga	8479
Burmese	7789	Interlingua	7365	Persian	7065	Turkish	8482
Byelorussian	6669	Irish	7165	Polish	8076	Turkmen	8475
Cambodian	7577	Italian	7384	Portuguese	8084	Twi	8487
Catalan	6765	Japanese	7465	Quechua	8185	Ukrainian	8575
Chinese	9072	Javanese	7487	Rhaeto-Romance	8277	Urdu	8582
Corsican	6779	Kannada	7578	Rumanian	8279	Uzbek	8590
Croatian	7282	Kashmiri	7583	Russian	8285	Vietnamese	8673
Czech	6783	Kazakh	7575	Samoan	8377	Volapük	8679
Danish	6865	Kirghiz	7589	Sanskrit	8365	Welsh	6789
Dutch	7876	Korean	7579	Scots Gaelic	7168	Wolof	8779
English	6978	Kurdish	7585	Serbian	8382	Xhosa	8872
Esperanto	6979	Laothian	7679	Serbo-Croatian	8372	Yiddish	7473
Estonian	6984	Latin	7665	Shona	8378	Yoruba	8979
Faroese	7079	Latvian, Lettish	7686	Sindhi	8368	Zulu	9085

Area Codes

Choose an area code from this list.

Area	Code	Area	Code	Area	Code	Area	Code
Afghanistan	AF	Ethiopia	ET	Malaysia	MY	Saudi Arabia	SA
Argentina	AR	Fiji	FJ	Maldives	MV	Senegal	SN
Australia	AU	Finland	FI	Mexico	MX	Singapore	SG
Austria	AT	France	FR	Monaco	MC	Slovak Republic	SK
Belgium	BE	Germany	DE	Mongolia	MN	Slovenia	SI
Bhutan	BT	Great Britain	GB	Morocco	MA	South Africa	ZA
Bolivia	BO	Greece	GR	Nepal	NP	South Korea	KR
Brazil	BR	Greenland	GL	Netherlands	NL	Spain	ES
Cambodia	KH	Islands	HM	Netherlands Antilles	AN	Sri Lanka	LK
Canada	CA	Hong Kong	HK	New Zealand	NZ	Sweden	SE
Chile	CL	Hungary	HU	Nigeria	NG	Switzerland	CH
China	CN	India	IN	Norway	NO	Taiwan	TW
Colombia	CO	Indonesia	ID	Oman	OM	Thailand	TH
Congo	CG	Israel	IL	Pakistan	PK	Turkey	TR
Costa Rica	CR	Italy	IT	Panama	PA	Uganda	UG
Croatia	HR	Jamaica	JM	Paraguay	PY	Ukraine	UA
Czech Republic	CZ	Japan	JP	Philippines	PH	United States	US
Denmark	DK	Kenya	KE	Poland	PL	Uruguay	UY
Ecuador	EC	Kuwait	KW	Portugal	PT	Uzbekistan	UZ
Egypt	EG	Libya	LY	Romania	RO	Vietnam	VN
El Salvador	SV	Luxembourg	LU	Russian Federation	RU	Zimbabwe	ZW

Troubleshooting

Symptom	Possible Cause	Correction
No power.	<ul style="list-style-type: none"> The power cord is disconnected. 	<ul style="list-style-type: none"> Plug the power cord into the wall outlet securely.
The power is on, but the DVD player does not work.	<ul style="list-style-type: none"> No disc is inserted. 	<ul style="list-style-type: none"> Insert a disc. (Check that the DVD or audio CD indicator in the display window is lit.)
No picture.	<ul style="list-style-type: none"> The TV is not set to receive DVD signal output. 	<ul style="list-style-type: none"> Select the appropriate video input mode on the TV.
	<ul style="list-style-type: none"> The video cable is not connected securely. 	<ul style="list-style-type: none"> Connect the video cable securely.
No sound.	<ul style="list-style-type: none"> The equipment connected with the audio cable is not set to receive DVD signal output. 	<ul style="list-style-type: none"> Select the correct input mode of the audio receiver so you can listen to the sound from the DVD player.
	<ul style="list-style-type: none"> The power of the equipment connected with the audio cable is turned off. 	<ul style="list-style-type: none"> Turn on the equipment connected with the audio cable.
	<ul style="list-style-type: none"> The AUDIO options are set to the wrong position. 	<ul style="list-style-type: none"> Set the Digital Audio Output to the correct position, then turn on the DVD player again by pressing POWER.
The DVD player does not start playback.	<ul style="list-style-type: none"> An unplayable disc is inserted. 	<ul style="list-style-type: none"> Insert a playable disc. (Check the disc type, color system, and regional code.)
	<ul style="list-style-type: none"> The rating level is set. 	<ul style="list-style-type: none"> Cancel the rating function or change the rating level.
The remote control does not work properly.	<ul style="list-style-type: none"> The remote control is not pointed at the remote sensor on the DVD player. 	<ul style="list-style-type: none"> Point the remote control at the remote sensor of the DVD player.
	<ul style="list-style-type: none"> The remote control is too far from the DVD player. 	<ul style="list-style-type: none"> Operate the remote control closer to the DVD player.

Specifications

General

Power requirements: AC 110-240 V , 50/60 Hz

Power consumption: 8W

Dimensions (Approx.):

DS9321P / DS9521P:

360 x 35 x 242 mm (W x H x D) without foot

DV9721P:

430 x 35 x 242 mm (W x H x D) without foot

Weight (Approx.):

DS9321P / DS9521P: 1.7 kg

DV9721P: 1.9 kg

Operating temperature:

5 °C to 35 °C (41 °F to 95 °F)

Operating humidity: 5 % to 90 %

Outputs

VIDEO OUT:

1 V_{p-p} 75 Ω, sync negative, RCA jack x 1

S-VIDEO OUT:

(Y) 1.0 V (p-p), 75 Ω, negative sync, Mini DIN 4-pin x 1

(C) 0.3 V (p-p) 75 Ω

COMPONENT VIDEO OUT:

(Y) 1.0 V (p-p), 75 Ω, negative sync, RCA jack x 1

(Pb)/(Pr) 0.7 V (p-p), 75 Ω, RCA jack x 2

AUDIO OUT:

2.0 V_{rms} (1 KHz, 0 dB), 600 Ω, RCA jack (L, R) x 1

DIGITAL OUT (COAXIAL):

0.5 V (p-p), 75 Ω, RCA jack x 1

DIGITAL OUT (OPTICAL):

3 V (p-p), 75 Ω, Optical connector x 1

System

Laser:

Semiconductor laser, wavelength 650 nm

Signal system: PAL / NTSC

Frequency response:

DVD (PCM 96 kHz): 8 Hz to 44 kHz

DVD (PCM 48 kHz): 8 Hz to 22 kHz

CD: 8 Hz to 20 kHz

Signal-to-noise ratio:

More than 100 dB (ANALOG OUT connectors only)

Harmonic distortion: Less than 0.008%

Dynamic range:

More than 95 dB (DVD/CD)

Accessories:

Video cable (1), Audio cable (1), Remote control (1),

Batteries (2)

Note: Design and specifications are subject to change prior notice.



P/NO : 3834RD0049A