

ENGLISH

M4410 User Guide

Please read this manual carefully before operating
your mobile phone. Retain it for future reference.

CE 0700



M4410 User Guide



ISSUE 1.0
PRINTED IN KOREA

P/N : MMBB0162312 ■



ENGLISH



M4410 User Guide

We would like to inform the users that this manual may have some differences from phone depending on phone S/W and service provider.

Contents

M4410 features	10	Caller groups [Menu 2-4]	30
Part of the phone	10	Own number [Menu 2-5]	30
Display Information	13	Settings [Menu 2-6]	31
On-Screen Icons	14		
Installation	15	Organiser [Menu 3]	33
Installing the SIM card and the handset battery	15	Calendar [Menu 3-1]	33
Charging the Battery	17	Memo [Menu 3-2]	34
Disconnecting the charger	17		
Memory card	18	Multimedia [Menu 4]	35
Inserting the memory card	18	Take photo [Menu 4-1]	35
Removing the memory card	18	Fun frames [Menu 4-2]	36
		Take silent movie [Menu 4-3]	36
General Functions	19	Voice recorder [Menu 4-4]	36
Making a Call	19	MP3 [Menu 4-5]	37
Adjusting the Volume	19	My photos [Menu 4-6]	39
Answering a Call	20	Silent movie [Menu 4-7]	39
Entering Text	20		
		Messages [Menu 5]	41
Selecting Functions and Options	23	New message [Menu 5-1]	41
In-Call Menu	24	Inbox [Menu 5-2]	43
During a Call	24	Outbox [Menu 5-3]	44
Conference Calls	25	Sent [Menu 5-4]	44
		Drafts [Menu 5-5]	44
Menu Tree	26	Listen to voice mail [Menu 5-6]	45
Games & more [Menu 1]	28	Info message [Menu 5-7]	45
Games & more [Menu 1-1]	28	Templates [Menu 5-8]	46
Settings [Menu 1-2]	28	Settings [Menu 5-9]	46
Contacts [Menu 2]	29	My stuff [Menu 6]	48
Add new [Menu 2-1]	29	Photos [Menu 6-1]	48
Search [Menu 2-2]	29	Pictures [Menu 6-2]	48
Speed dial [Menu 2-3]	30	Silent movie [Menu 6-3]	48
		Sounds [Menu 6-4]	48
		Music [Menu 6-5]	49

Others [Menu 6-6]	49	Received calls [Menu 0-2]	58
External Memory [Menu 6-7]	49	Dialled calls [Menu 0-3]	58
Display [Menu 7]	50	All calls [Menu 0-4]	58
Wallpaper [Menu 7-1]	50	Delete recent calls [Menu 0-5]	58
Menu colour [Menu 7-2]	50	Call charges [Menu 0-6]	59
Greeting note [Menu 7-3]	50	GPRS information [Menu 0-7]	59
Backlight [Menu 7-4]	50	Settings [Menu #]	60
Information window [Menu 7-5]	50	Date & Time [Menu #-1]	60
Profiles [Menu 8]	51	Languages [Menu #-2]	60
Activate [Menu 8-X-1]	51	Call settings [Menu #-3]	60
Personalise [Menu 8-X-2]	51	Security settings [Menu #-4]	62
Rename [Menu 8-X-3]	51	Network settings [Menu #-5]	63
Tools [Menu 9]	52	GPRS settings [Menu #-6]	64
Favourites [Menu 9-1]	52	Memory status [Menu #-7]	64
Alarm clock [Menu 9-2]	52	Reset settings [Menu #-8]	64
Bluetooth [Menu 9-3]	52	Accessories	65
SyncML [Menu 9-4]	53	Technical Data	66
Calculator [Menu 9-5]	54		
Unit converter [Menu 9-6]	54		
World time [Menu 9-7]	54		
SIM-Menu [Menu 9-8]	54		
Browser [Menu *]	55		
Home [Menu *-1]	55		
Bookmarks [Menu *-2]	55		
Go to URL [Menu *-3]	56		
Settings [Menu *-4]	56		
Browser version [Menu *-5]	57		
Call register [Menu 0]	58		
Missed calls [Menu 0-1]	58		

Congratulations on your purchase of the advanced and compact M4410 cellular phone, designed to operate with the latest digital mobile communication technology.



This user's guide contains important information on the use and operation of this phone. Please read all the information carefully for optimal performance and to prevent any damage to or misuse of the phone. Any changes or modifications not expressly approved in this user's guide could void your warranty for this equipment.

Using the magnetic lock case for folder type phones will cause some problems such as self power off, absence of network and warranty will be void in this case.

Read these simple guidelines. Breaking the rules may be dangerous or illegal. Further detailed information is given in this manual.

Warning

- Mobile Phones must be switched off at all times in an aircraft.
- Do not hold the phone in your hand while driving.
- Do not use your phone near petrol stations, fuel depots, chemical plants or blasting operations.
- For your safety, use ONLY specified ORIGINAL batteries and chargers.
- Do not handle the phone with wet hands while it is being charged. It may cause an electric shock or seriously damage your phone.
- Keep the phone in a safe place out of children's reach. It includes small parts which if detached may cause a choking hazard.

Caution

- Switch off the phone in any area where required by special regulations. For example, do not use your phone in hospitals or it may affect sensitive medical equipment.
- Emergency call may not be available under all cellular networks. Therefore, you should never depend solely on the phone for emergency calls.
- Only use ORIGINAL accessories to avoid damage to your phone.
- All radio transmitters carry risks of interference with electronics in close proximity. Minor interference may affect TVs, radios, PCs, etc.
- Batteries should be disposed of in accordance with relevant legislation.
- Do not dismantle the phone or battery.

Guidelines for safe and efficient use

Radio wave exposure and Specific Absorption Rate (SAR) information

This mobile phone model M4410 has been designed to comply with applicable safety requirement for exposure to radio waves. This requirement is based on scientific guidelines that include safety margins designed to assure this safety of all persons, regardless of age and health.

- The radio wave exposure guidelines employ a unit of measurement known as the Specific Absorption Rate, or SAR. Tests for SAR are conducted using standardized method with the phone transmitting at its highest certified power level in all used frequency bands.
- While there may be differences between the SAR levels of various LG phone models, they are all designed to meet the relevant guidelines for exposure to radio waves.
- The SAR limit recommended by the international Commission on Non-Ionizing Radiation Protection (ICNIRP), which is 2W/kg averaged over ten (10) gram of tissue.
- The highest SAR value for this model phone tested by DASy4 for use at the ear is 0.497 W/kg (10g).
- SAR data information for residents in countries/regions that have adopted the SAR limit

recommended by the Institute of Electrical and Electronics Engineers (IEEE), which is 1.6 W/kg averaged over one (1) gram of tissue.

Product care and maintenance

⚠ Warning

Use only batteries, charger and accessories approved for use with this particular phone model. The use of any other types may invalidate any approval or warranty applying to the phone, and may be dangerous.

- Do not disassemble this unit. Take it to a qualified service technician when repair work is required.
- Keep away from electrical appliance such as a TV, radio or personal computer.
- The unit should be kept away from heat sources such as radiators or cookers.
- Do not drop.
- Do not subject this unit to mechanical vibration or shock.
- The coating of the phone may be damaged if covered with wrap or vinyl wrapper.
- Do not use harsh chemicals (such as alcohol, benzene, thinners, etc.) or detergents to clean your phone. There is a risk of this causing a fire.
- Do not subject this unit to excessive smoke or dust.
- Do not keep the phone next to credit cards or transport tickets; it can affect the information on the

magnetic strips.

- Do not tap the screen with a sharp object, as it may damage the phone.
- Do not expose the phone to liquid or moisture.
- Use the accessories like an earphone cautiously.
- If you put your phone in a pocket or bag without covering the receptacle of the phone (power plug pin), metallic articles (such as a coin, paperclip or pen) may short-circuit the phone. Always cover the receptacle when not in use.
- Never place your phone in a microwave oven as it will cause the battery to explode.
- Only authorized personnel should service the phone and its accessories. Faulty installation or service may result in accidents and consequently invalidate the warranty.
- Do not use the phone if the antenna is damaged. If a damaged antenna contacts skin, it may cause a slight burn. Please contact an LG Authorized Service Center to replace the damaged antenna.
- The label of the phone contains important information for customer support purposes. Do not remove it.

Efficient phone operation

To enjoy optimum performance with minimum power consumption please:

- Hold the phone as you speak to any other telephone. While speaking directly into the microphone, angle the antenna in a direction up and over your shoulder. If the antenna is extendable/ retractable, it should be extended during a call.
- Do not hold the antenna when the phone is in use. If you hold it, it can affect call quality, it also may cause the phone to operate at a higher power level than needed and shorten talk and standby times.
- If your mobile phone supports infrared, never direct the infrared ray at anyone's eye.

Electronics devices

All mobile phones may get interference, which could affect performance.

- Do not use your mobile phone near medical equipment without requesting permission. Avoid placing the phone over the pacemaker, i.e. in your breast pocket.
- Some hearing aids might be disturbed by mobile phones.
- Minor interference may affect TVs, radios, PCs, etc.
- Do not bend, scratch, or expose to static electricity.

Guidelines for safe and efficient use

Road safety

Check the laws and regulations on the use of mobile phones in the areas when you drive.

- Do not use a hand-held phone while driving.
- Give full attention to driving.
- Use a hands-free kit, if available.
- Pull off the road and park before making or answering a call if driving conditions so require.
- RF energy may affect some electronic systems in your motor vehicle such as car stereo, safety equipment.
- When riding in a car, do not leave your phone or set up the hands-free kit near to the air bag. If wireless equipment is improperly installed and the air bag is activated, you may be seriously injured.

Blasting area

Do not use the phone where blasting is in progress. Observe restrictions, and follow any regulations or rules.

Potentially explosive atmospheres

- Do not use the phone at a refueling point. Don't use near fuel or chemicals.
- Do not transport or store flammable gas, liquid, or explosives in the compartment of your vehicle, which contains your mobile phone and accessories.

In aircraft

Wireless devices can cause interference in aircraft.

- Turn off your mobile phone before boarding any aircraft.
- Do not use it on the ground without crew permission.

Battery information and care

- You do not need to completely discharge the battery before recharging. Unlike other battery systems, there is no memory effect that could compromise the battery's performance.
- Use only LG batteries and chargers. LG chargers are designed to maximize the battery life.
- Do not disassemble or short-circuit the battery pack.
- Keep the metal contacts of the battery pack clean.
- Replace the battery when it no longer provides acceptable performance. The battery pack may be recharged hundreds of times until it needs replacing.
- Recharge the battery if it has not been used for a long time to maximize usability.
- Do not expose the battery charger to direct sunlight or use it in high humidity, such as the bathroom.
- Do not leave the battery in hot or cold places, this may deteriorate the battery performance.

Memory card information and care

- Always insert/ remove the memory card while the handset power is off. If you remove it on writing application, it may be damaged.
- If a damage cannot be fixed, format the memory card.
- The memory card cannot be used for recording copyright- protected data.

- Do not write forcefully on the memo area.
- Carry and store the memory card in its case.
- Do not allow the memory card to get wet.
- Do not leave the memory card in extremely hot location.
- Do not disassemble or modify the memory card.

Network service

- Some services and functions described in this user's guide are dependent on network or subscription. Therefore, all menus may not be available in your phone. Please consult network operator for more information about your subscription.

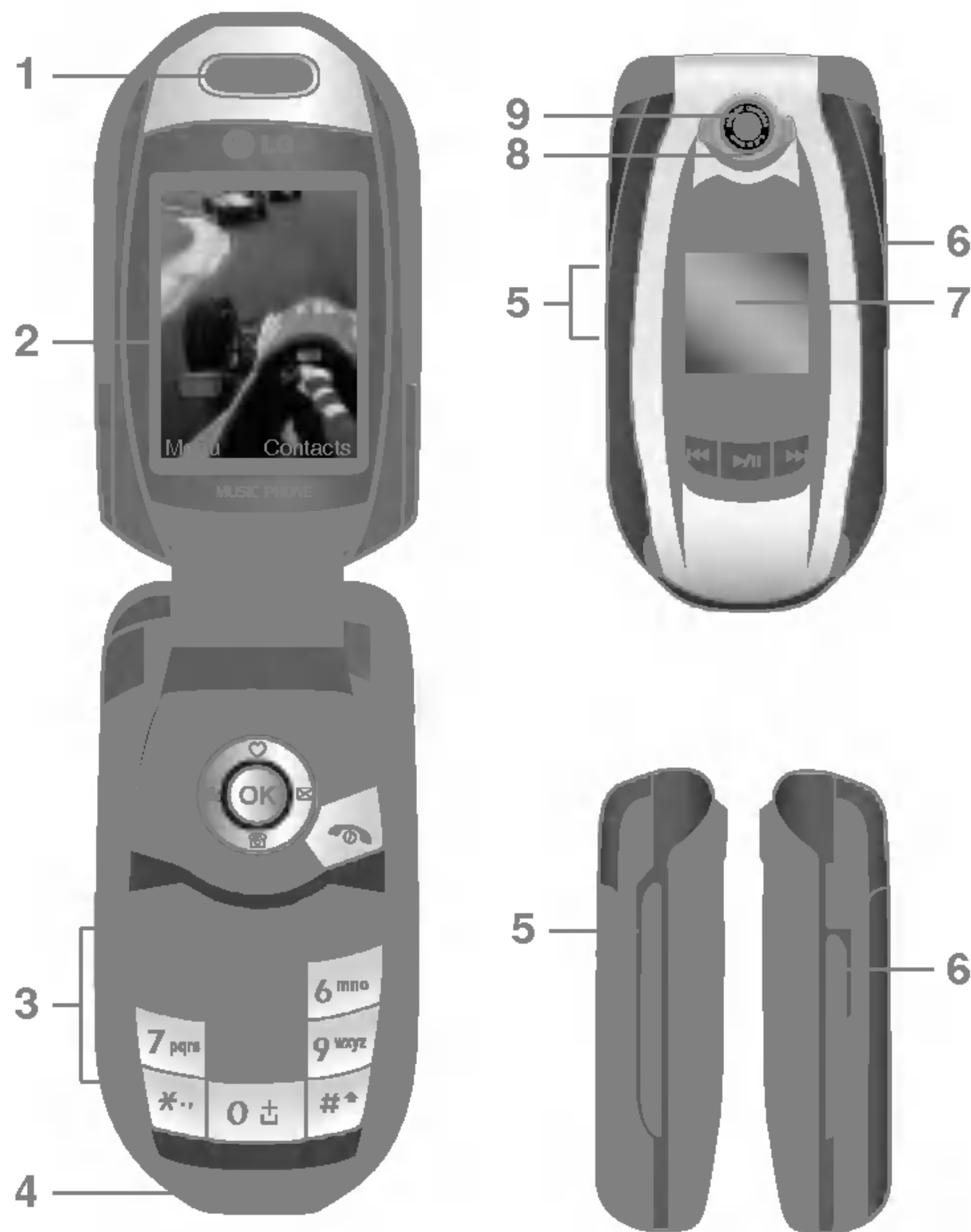

Part of the phone

1. Earpiece

2. Main LCD

- **Top:** Signal strength, battery level and various function
- **Bottom:** Soft key indications

3. Alpha numeric keys

- **In standby mode:** Input numbers to dial Hold down
 - - International calls
 - - Activate Voice mail centre menu
 - to ■ - Speed dials

- **In editing mode:** Enter numbers & characters

4. Microphone

5. Side keys

- **In standby mode (opened):** Volume of key tone
- **In standby mode (closed):** Switch the flash light on. (hold down)
- **In menu:** scroll up & down
- **During a call:** volume of the earpiece

6. Side camera key

7. Sub LCD

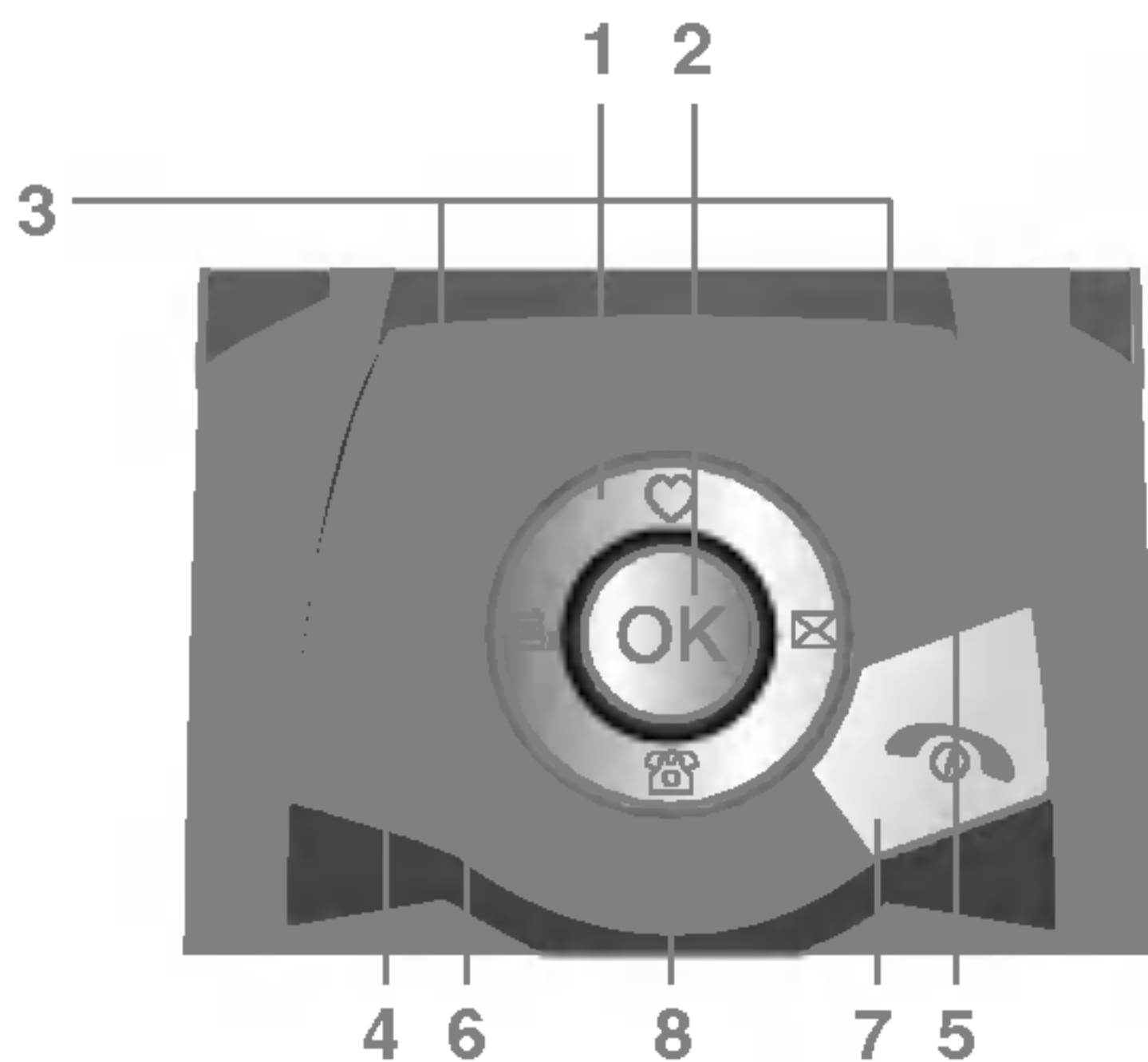

8. Flash

9. Camera lens



1. Navigation key

- **In standby mode:**

-  **Briefly:** List of Favourites
-  **Briefly:** List of Contacts
-  **Briefly:** List of Messages
-  **Briefly:** List of Profiles
-  **Hold down:** Activate/Deactivate Vibrate mode

- **In menu:** scroll up & down

2. Confirm key

3. Soft keys

- These keys perform the function indicated in the bottom of the display.

4. MP3 hot key

- Activate the MP3 menu directly.

5. Camera hot key

- Activates the camera menu directly.

6. Send key

- Dial a phone number and answer a call.
- **In standby mode:** shows recently dialed, received and missed call.

7. End key

- Switched on/off (hold down)
- End or reject a call.

8. Clear key

Rear view

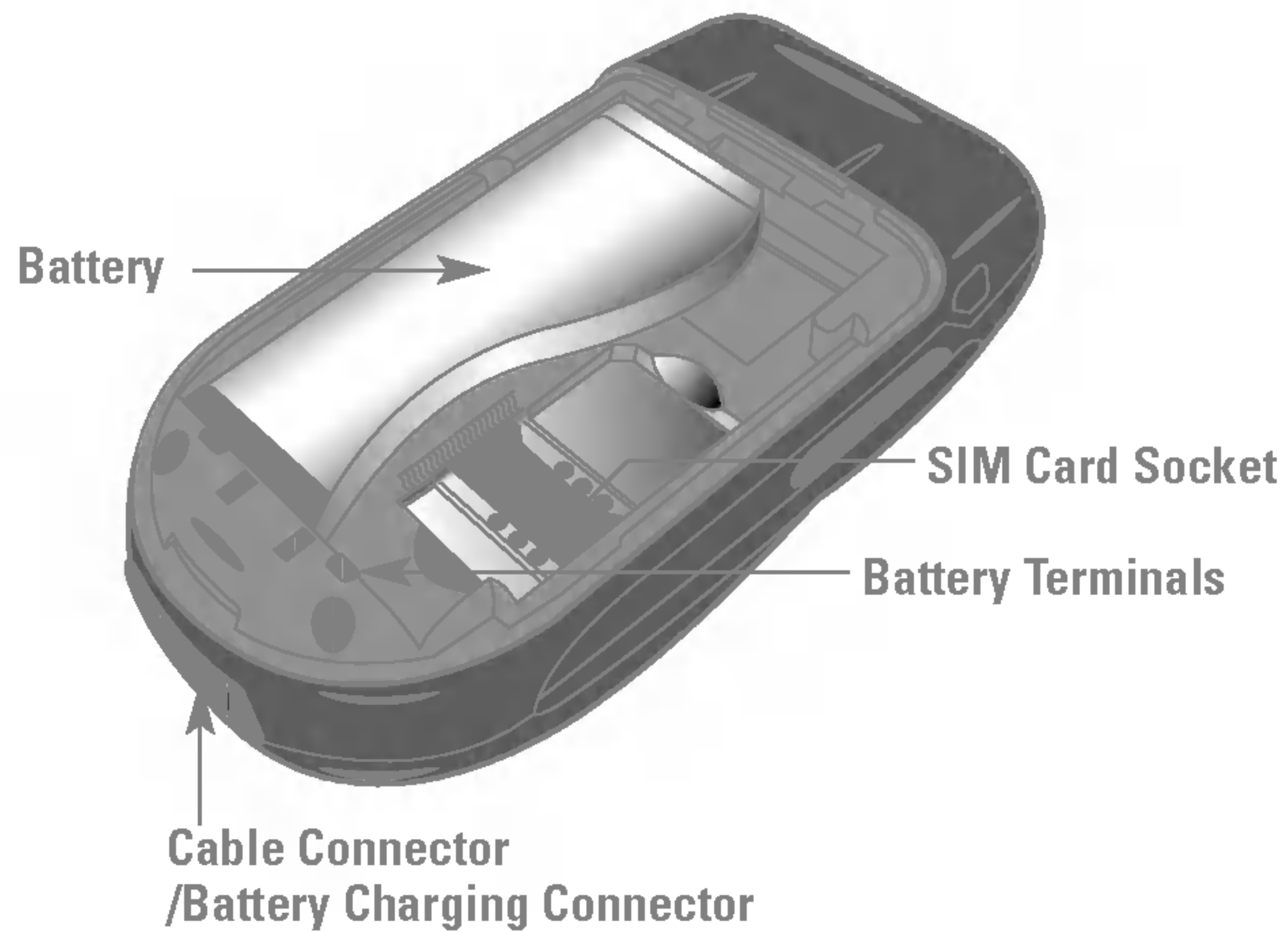



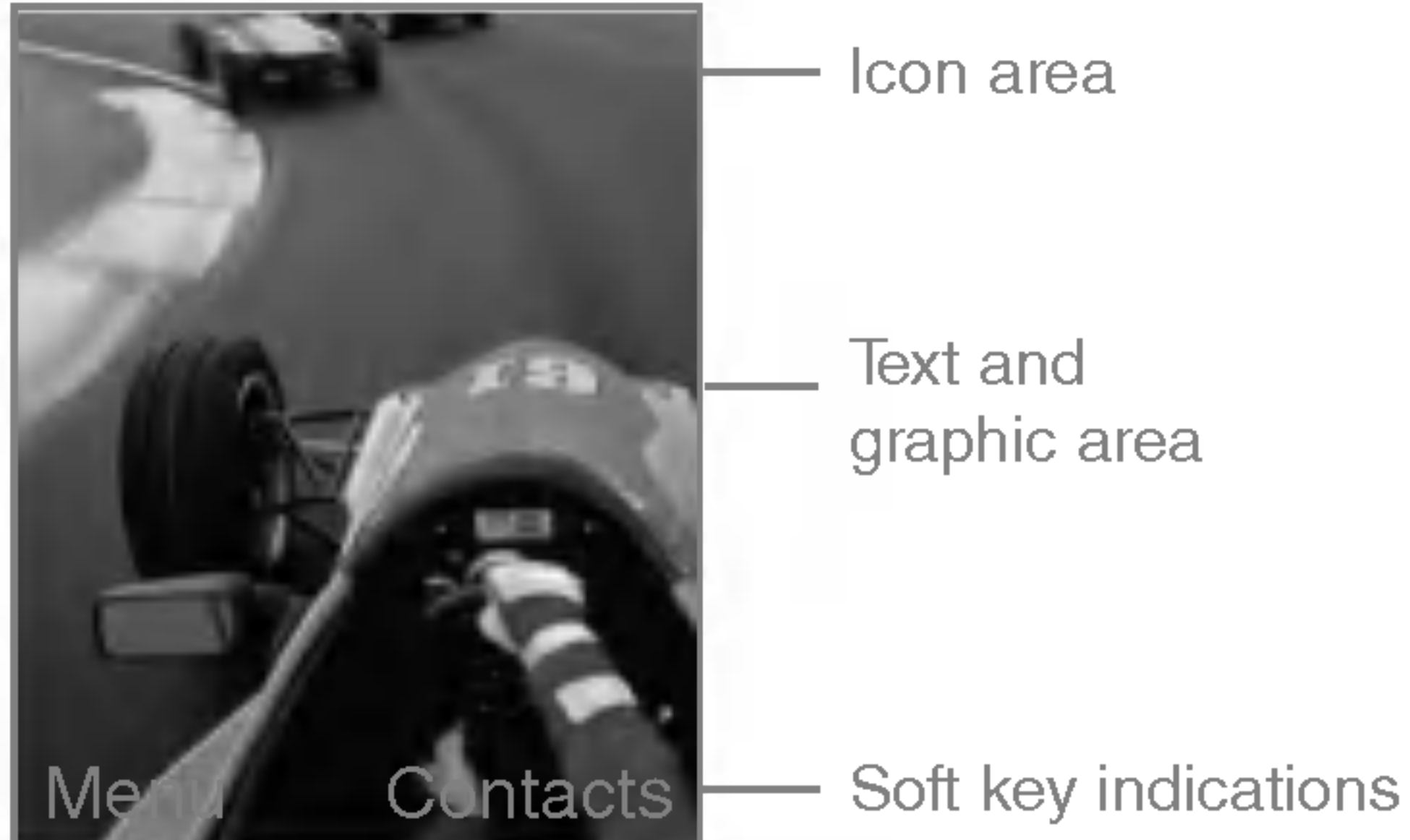



Display Information











Display Information	
First line	Displays various icons. See page 14.
Middle lines	Display messages, instructions and any information that you enter, such as number to be dialed.
Last line	Shows the functions currently assigned to the two soft keys.

The screen displays several icons. There are described below.

On-Screen Icons

Icon/Indicator	Description
	Tells you the strength of the network signal.
	Call is connected.
	Shows that you are using a roaming service.
	The alarm has been set and is on.
	Tells you the status of the battery.
	You have received a text message.
	You have received a voice message.

Note The quality of the conversation may change depending on network coverage. When the signal strength is below 2 bars, you may experience muting, call drop and bad audio. Please take the network bars as indicator for your calls. When there are no bars, that means that there is no network coverage: in this case, you won't be able to access the network for any service (call, messages and so on).

Icon/Indicator	Description
	Vibrate only menu in profile.
	General menu in profile.
	Loud menu in profile.
	Silent menu in profile.
	Headset menu in profile.
	You can divert a call.
	Indicates that the phone is accessing the WAP.
	Indicates that you are using GPRS.
	You have activated bluetooth menu.
E	Shows the EDGE service is available. Connection to the EDGE service allows you to transfer data at a speed of 200Kb/s (depending on network availability). Check with your operator for network coverage and service availability.

Installing the SIM card and the handset battery

Make sure the power is off before you remove the battery.

1. Remove the battery cover.

Press the battery release latch and slide the battery cover toward the bottom of the phone. And remove the battery cover.

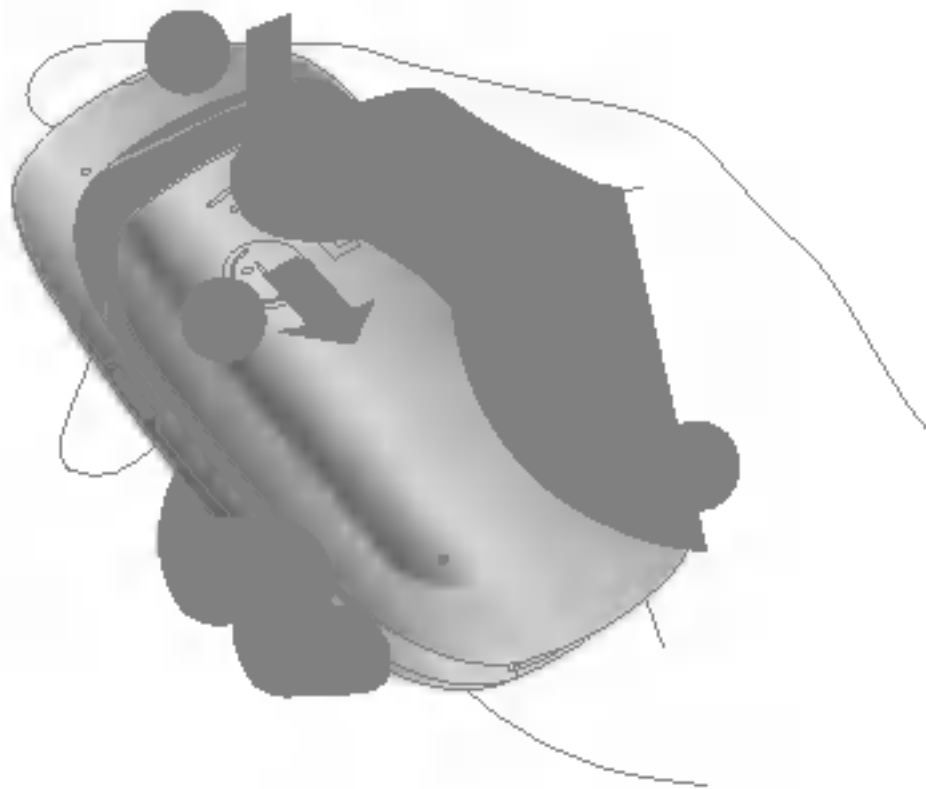

Note Removing the battery from the phone when the power is on may cause the phone to malfunction.

2. Remove the battery.

Hold the top edge of the battery and lift the battery from the battery compartment.

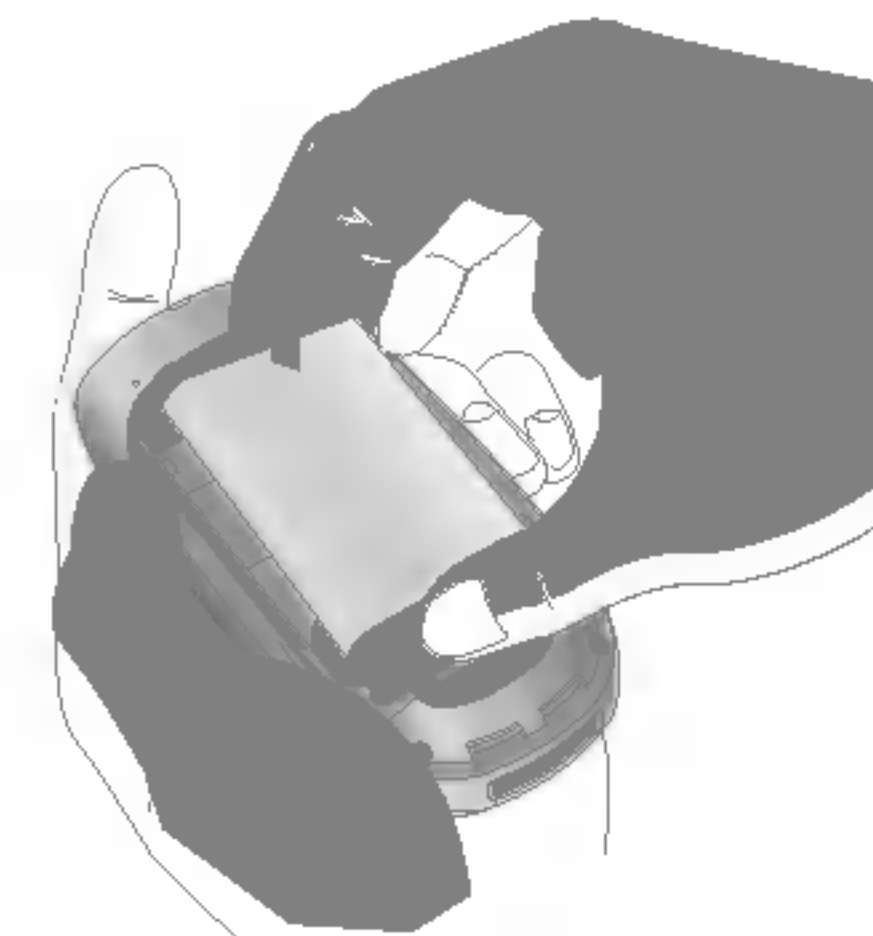

3. Install the SIM card.

Insert the SIM card into the holder. Slide the SIM card into the SIM card holder. Make sure that the SIM card is inserted properly and that the gold contact area on the card is facing downwards. To remove the SIM card, press down lightly and pull it in the reverse direction.



To insert the SIM card

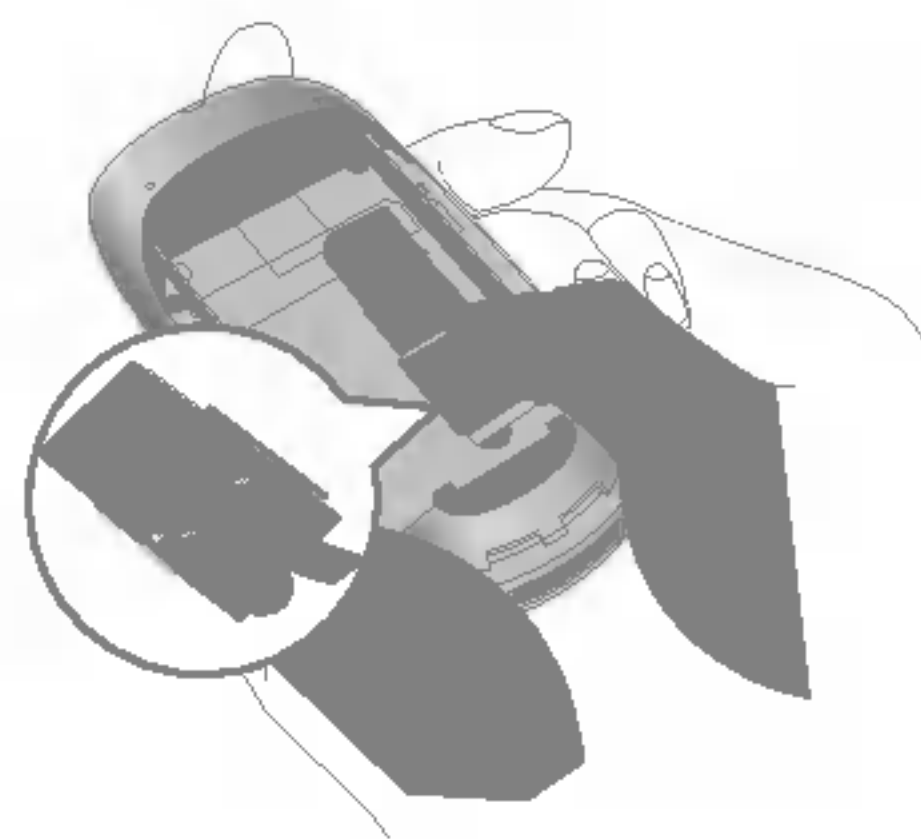

To remove the SIM card

Note The metal contact of the SIM card can be easily damaged by scratches. Pay special attention to the SIM card while handling. Follow the instructions supplied with the SIM card.

4. Install the battery.

Insert the bottom of the battery first into the bottom edge of the battery compartment. Push down the top of the battery until it snaps into space.



5. Replace the battery cover.

Lay the battery cover in place of the phone and slide it until the latch clicks.

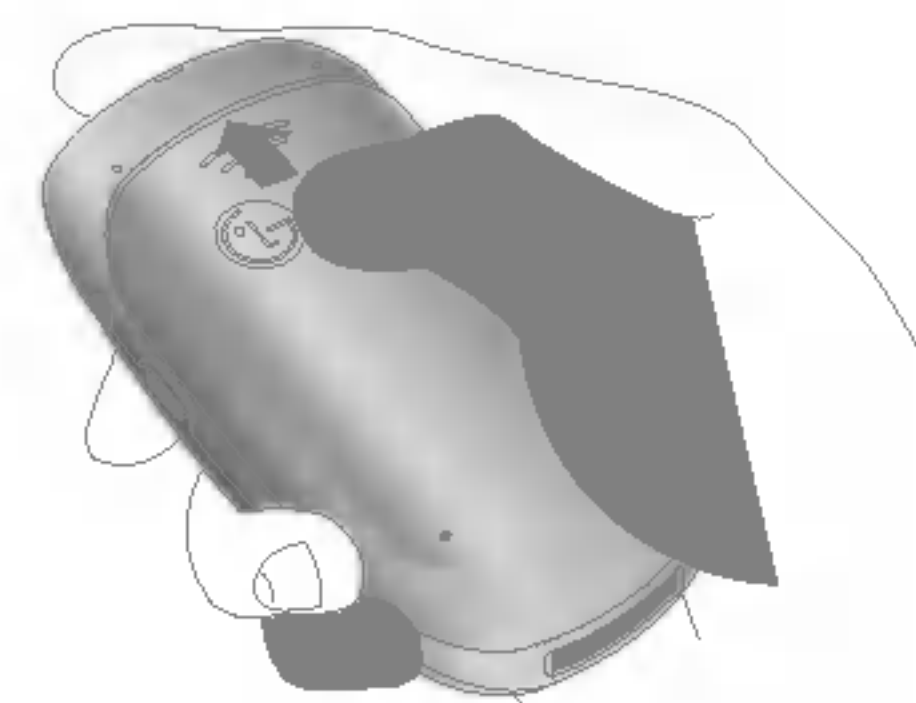

Charging the Battery

To connect the travel adapter to the phone, you must have installed the battery.

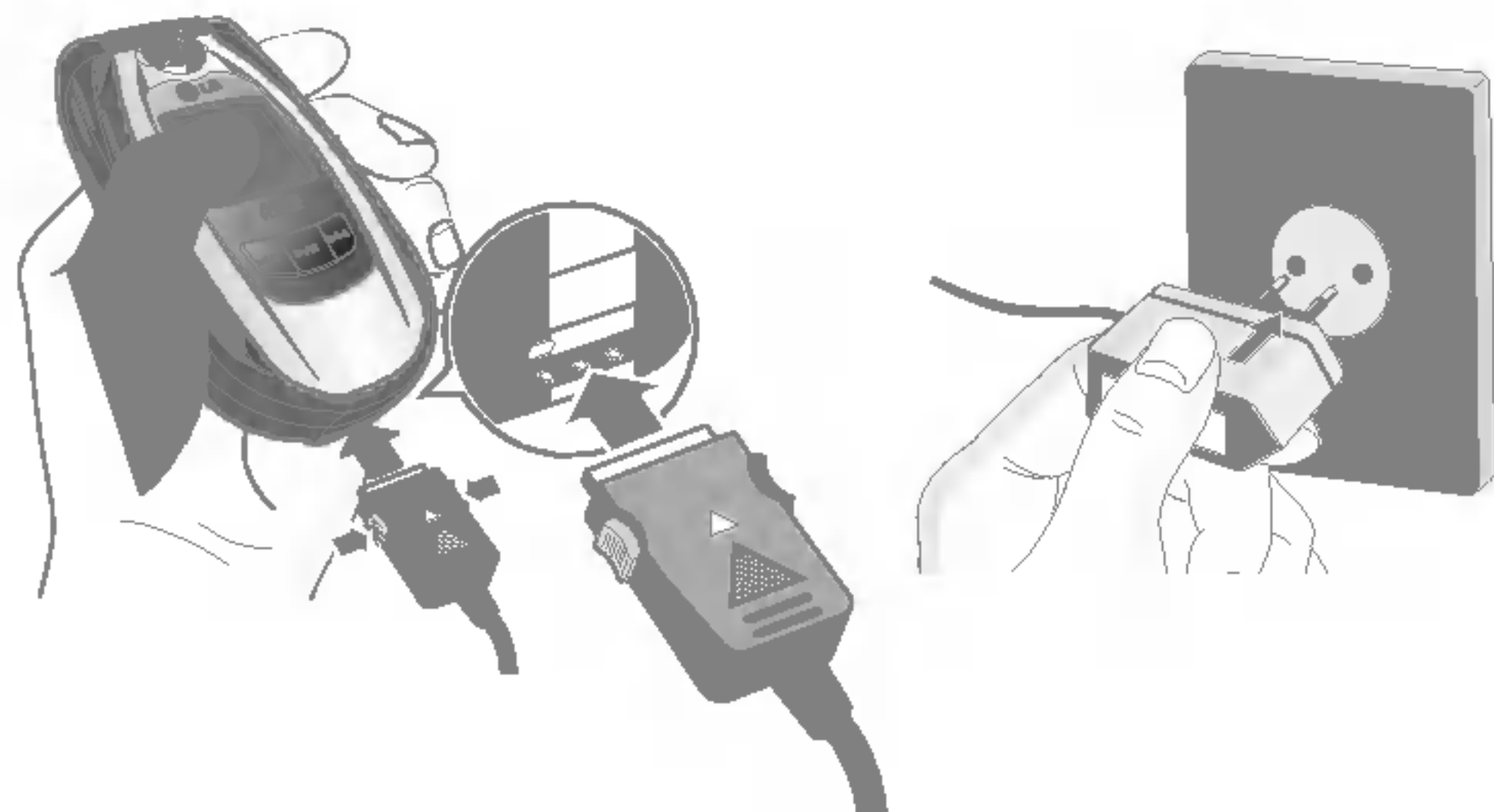

1. Ensure the battery is fully charged before using the phone.
2. With the arrow facing you as shown in the diagram push the plug on the battery adapter into the socket on the bottom of the phone until it clicks into place.
3. Connect the other end of the travel adapter to the mains socket. Use only the included charger.
4. The moving bars of battery icon will stop after charging is complete.

- ⚠ **Caution**
 - Do not force the connector as this may damage the phone and/or the travel adapter.
 - Insert the battery pack charger vertically to wall power outlet.
 - If you use the battery pack charger out of your own country, use an attachment plug adaptor for the proper configuration.
 - Do not remove your battery or the SIM card while charging.
- ⚠ **Warning**
 - Unplug the power cord and charger during lightning, storms to avoid electric shock or fire.
 - Make sure that no sharp-edged items such as animal teeth, nails, come into contact with the battery. There is a risk of this causing a fire.
 - Do not place or answer calls while charging the phone as it may cause a shock.

Disconnecting the charger

Disconnect the travel adapter from the phone by pressing its side buttons as shown in the diagram.

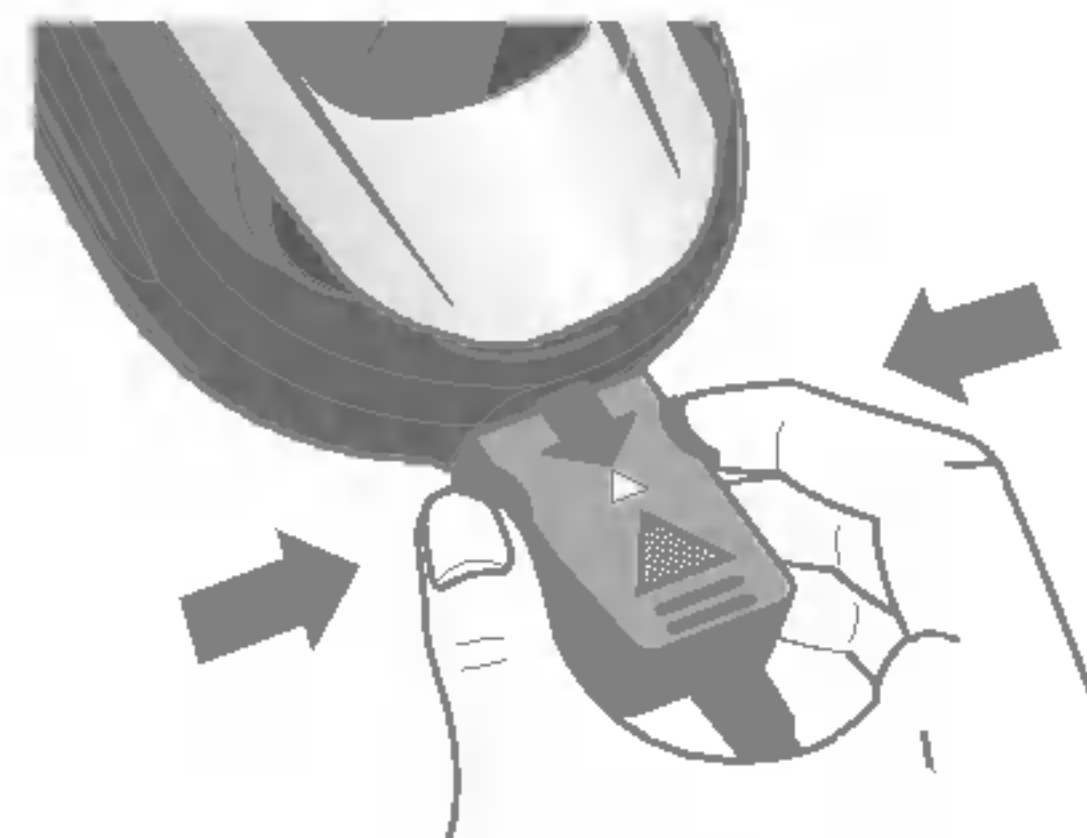

Memory card

M4410 is equipped on the side with Mini SD memory card with a maximum of 128MB capacity. You can use this card to save data files such as photos, video, audio, contact point, schedule.

Note Always insert/remove the memory card with the handset power off.

Inserting the memory card

Insert the memory card into the slot until the memory card is fully inserted into the slot, as shown in the figure below:



Open the memory card slot

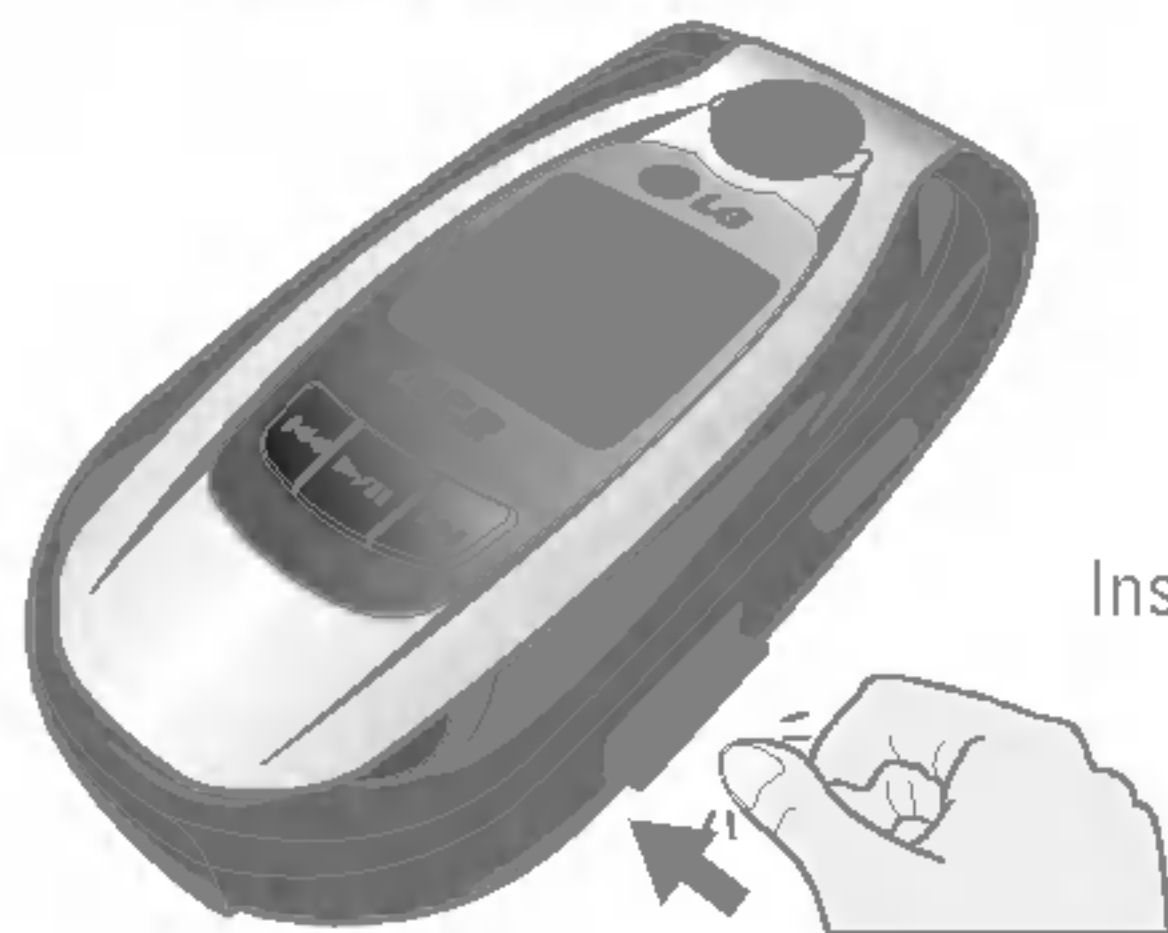

Insert the memory card



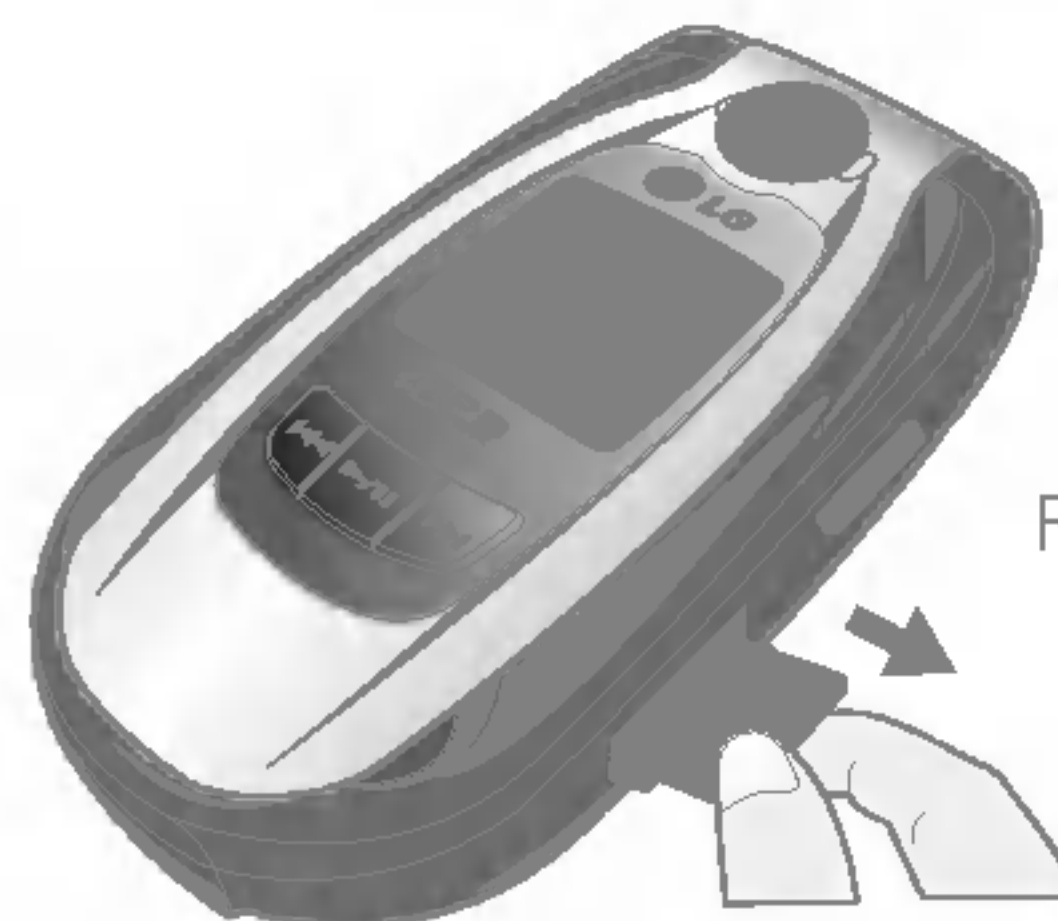

Removing the memory card

1. Push in memory card with the tip of your finger into the slot.
2. Carefully pull the memory card out of slot.





Remove the memory card



Making a Call

1. Make sure your phone is powered on.
2. Enter a phone number including the area code. To edit a number on the display screen, simply press the  key to erase one digit at a time.
 - ▶ Press and hold the  key to erase the entire number.
3. Press the  key to call.
4. When you want to finish, press the  key.

Making a Call by Send Key

1. Press the  key, and the most recent incoming, outgoing and missed phone numbers will be displayed.
2. Select the desired number by using the navigation key.
3. Press the  key.

Making International Calls

1. Press and hold the  key for the international prefix. The '+' character can be replaced with the international access code.
2. Enter the country code, area code, and the phone number.
3. Press the  key.

Ending a Call

When you have finished a call, press the  key.

Making a Call From the Contact list

You can store names and phone numbers, dialled frequently in the SIM card as well as the phone memory known as the Contact list.

You can dial a number by simply looking up a name in the contact list. For more details on the Contacts feature, please refer to page 29.



Adjusting the Volume

During a call, if you want to adjust the earpiece volume, use the side keys of the phone.

In idle mode, you can adjust the key volume using the side keys.

Answering a Call

When you receive a call, the phone rings and the flashing phone icon appears on the screen. If the caller can be identified, the caller's phone number (or name if stored in your Address Book) is displayed.

1. Open the flip and press the  key or the left soft key to answer an incoming call. If the Any Key menu option (Menu #-3-2) has been set to any key press will answer a call except for the  key or the right soft key.

Note To reject an incoming call, press and hold the side keys on the left side of the phone.

2. End the call by closing the phone or pressing the  key.

Note You can answer a call while using the Address Book or other menu features.

Vibrate Mode (Quick)

Vibrate Mode can be activated by pressing and holding the left side of navigation key.

Signal Strength

If you are inside a building, being near a window may give you better reception. You can see the strength of your signal by the signal indicator () on your phone's display screen.

Entering Text

You can enter alphanumeric characters by using the phone's keypad. For example, storing names in the Address Book, writing a message, creating scheduling events in the calendar all require entering text. The following text input methods are available in the phone.

Note Some fields may allow only one text input mode (e.g. telephone number in address book fields).

T9 Mode

This mode allows you to enter words with only one keystroke per letter. Each key on the keypad has more than one letter. The T9 mode automatically compares your keystrokes with an internal linguistic dictionary to determine the correct word, thus requiring far fewer keystrokes than the traditional ABC mode.

ABC Mode

This mode allows you to enter letters by pressing the key labeled with the required letter once, twice, three or four times until the letter is displayed.

123 Mode (Numbers Mode)

Type numbers using one keystroke per number. To change to 123 mode in a text entry field, press  key until 123 mode is displayed.

Symbolic Mode

This mode allows you to enter special characters.



Changing the Text Input Mode

1. When you are in a field that allows characters to be entered, you will notice the text input mode indicator in the upper right corner of the display.
2. If you want to change modes, press .
The available modes are changed.





Using the T9 Mode

The T9 predictive text input mode allows you to enter words easily with a minimum number of key presses. As you press each key, the phone begins to display the characters that it thinks you are typing based on a built-in dictionary. As new letters are added, the word changes to reflect the most likely candidate from the dictionary.

- **Note** You can select a different T9 language from the menu option or press hold down the key . The default setting on the phone is T9 disable mode.



1. When you are in the T9 predictive text input mode, start entering a word by pressing keys  to . Press one key per letter.
 - ▶ The word changes as letters are typed - ignore what's on the screen until the word is typed completely.
 - ▶ If the word is still incorrect after typing completely, press the down navigation key once or more to cycle through the other word options.

Example: Press     to type **Good**.











- ▶ If the desired word is missing from the word choices list, add it by using the ABC mode.
2. Enter the whole word before editing or deleting any keystrokes.
 3. Complete each word with a space by pressing the key  or  key.
To delete letters, press . Press and hold down  to erase the letters continuously.
- **Note** To exit the text input mode without saving your input, press . The phone returns to the idle screen.

Using the ABC Mode

Use the keys to enter the text.

1. Press the key labeled with the required letter:
 - ▶ Once for the first letter.
 - ▶ Twice for the second letter.
 - ▶ And so on.
2. To insert a space, press the  key once. To delete letters, press the  key. Press and hold down the  key to erase the letters continuously.

Note Refer the table below for more information on the characters available using the keys.

Key	Characters in the Order Display	
	Upper Case	Lower Case
	.,/?!-:!' " 1	.,/?!-:!' " 1
	A B C 2	a b c 2
	D E F 3	d e f 3
	G H I 4	g h i 4
	J K L 5	j k l 5
	M N O 6	m n o 6
	P Q R S 7	p q r s 7
	T U V 8	t u v 8
	W X Y Z 9	w x y z 9
	Space 0	Space 0

Using the 123 (Numbers) Mode



The 123 Mode enables you to enter numbers in a text message (a telephone number, for example).

Press the keys corresponding to the required digits before manually switching back to the appropriate text entry mode.

Using the Symbol Mode

The Symbol Mode enables you to enter various symbols or special characters.

To enter a symbol, press the  key. Use the navigation keys to select the desired symbol and press the [OK] key.

Your phone offers a set of functions that allow you to customize the phone. These functions are arranged in menus and sub-menus, accessed via the two soft keys marked  and . Each menu and sub-menu allows you to view and alter the settings of a particular function.

The roles of the soft keys vary according to the current context; the label on the bottom line of the display just above each key indicates its current role.

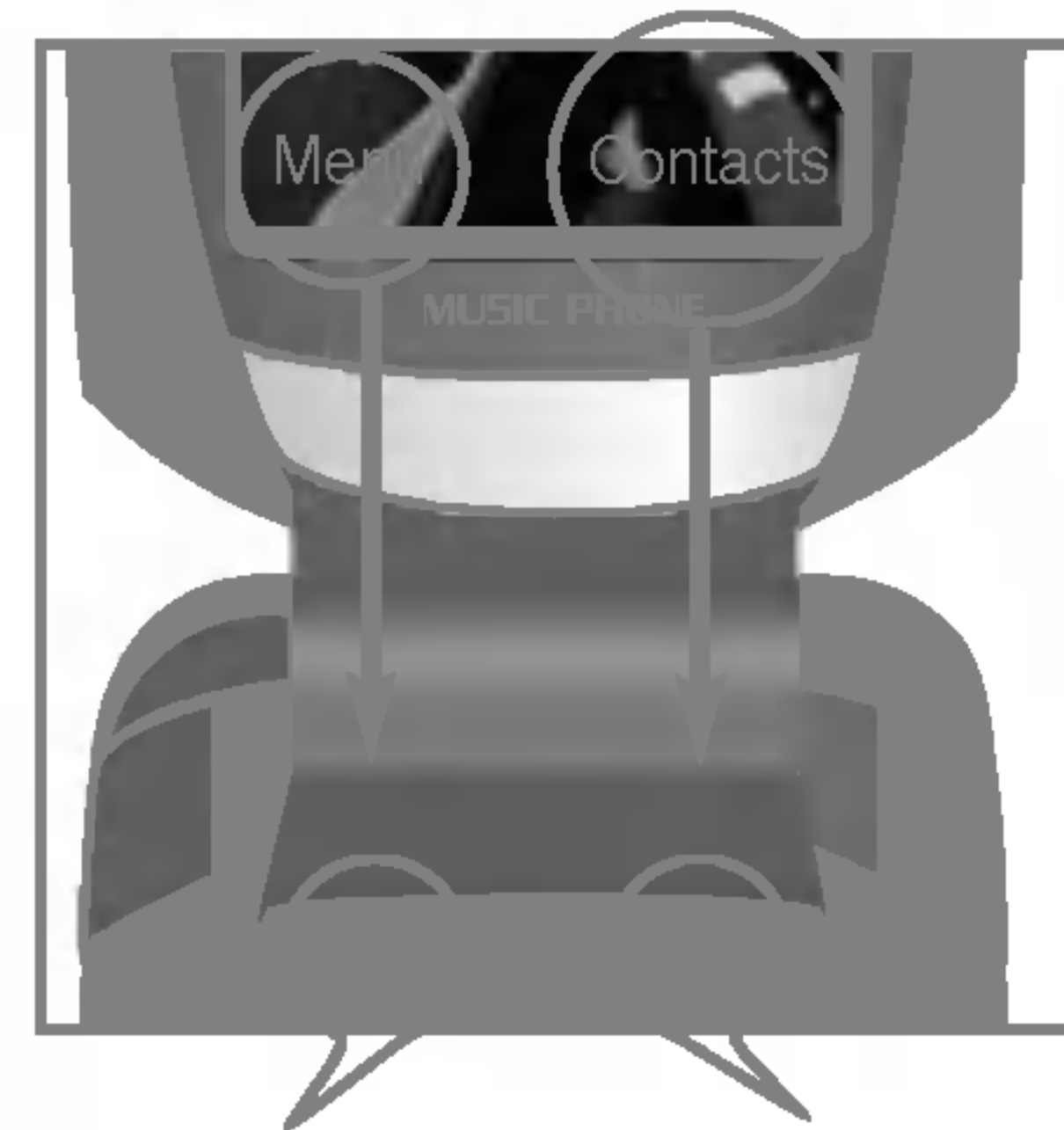

Press the left soft key to access the available Menu.

Press the right soft key to access the available Contacts.

Your phone provides a number of control functions that you can use during a call. To access these functions during a call, press the left soft key [Options].

During a Call

The menu displayed on the handset screen during a call is different than the default main menu displayed when in idle screen, and the options are described below.

Making a Second Call (Network Dependent)

You can get a number you wish to dial from the Address Book to make a second call. Press the Right soft key then select Contacts.

Swapping Between Two Calls

To switch between two calls, press  key or the left soft key, and then select Swap.

Answering an Incoming Call

To answer an incoming call when the handset is ringing, simply press the  key. The handset is also able to warn you of an incoming call while you are already on a call. A tone sounds in the earpiece, and the display will show that a second call is waiting. This feature, known as **Call Waiting**, is only available if your network supports it.

For details of how to activate and deactivate it see **Call Waiting** (Menu #-3-4).

If Call Waiting is on, you can put the first call on hold and answer the second, by pressing .

Rejecting an Incoming Call

You can reject an incoming call without answering by simply pressing the  key.

During a call, you can reject an incoming call by pressing the  key.

Muting the Microphone

You can mute the microphone during a call by pressing the [Options] key then selecting [Mute]. The handset can be unmuted by pressing the [Unmute]. When the handset is muted, the caller cannot hear you, but you can still hear him.



DTMF tones while calling

To switch on DTMF tones while calling (e.g. to use the phone with an automatic switchboard) press the key [Options] followed by Send DTMF – DTMF on. Select DTMF off to disable DTMF tones. DTMF tones are normally on.

Conference Calls

The conference service provides you with the ability to have a simultaneous conversation with more than one caller, if your network service provider supports this feature. A conference call can only be set up when you have one active call and one call on hold, both calls having been answered. Once a conference call is set up, calls may be added, disconnected or separated (that is, removed from the conference call but still connected to you) by the person who set up the conference call. These options are all available from the In-Call menu. The maximum callers in a conference call are five. Once started, you are in control of the conference call, and only you can add calls to the conference call.

Making a Second Call

You can make a second call while currently on a call. Enter the second number and press the . When the second call is connected, the first call is automatically placed on hold. You can swap between calls, by pressing the  key.

Setting Up a Conference Call

To set up a conference call, place one call on hold and while the active call is on, press the left soft key and then select the Join menu of Conference call.

Activate the Conference Call on Hold

To activate a conference call on hold, press the  key. Alternatively press the left soft key [Options] and select Conference/Hold all calls. Other users on hold will stay connected. To return to conference call mode, press the left soft key [Options] followed by Conference call.

Adding Calls to the Conference Call

To add a call to an existing conference call, press the left soft key, and then select the Join menu of Conference call.

Private Call in a Conference Call

To have a private call with one caller from a conference call, display the number of the caller you wish to talk to on the screen, then press the left soft key. Select the Private menu of Conference call to put all the other callers on hold.

Ending a Conference Call

Currently displayed caller from a conference call can be disconnected by pressing the  key.

1 Games & more



- 1 Games & more
- 2 Settings

2 Contacts



- 1 Add new
- 2 Search
- 3 Speed dial
- 4 Caller groups
- 5 Own number
- 6 Settings

3 Organiser



- 1 Calendar
- 2 Memo

4 Multimedia



- 1 Take photo
- 2 Fun frames
- 3 Take silent movie
- 4 Voice recorder
- 5 MP3
- 6 My photos
- 7 Silent movie
- 8 Settings

5 Messages



- 1 New message
- 2 Inbox
- 3 Outbox
- 4 Sent
- 5 Drafts
- 6 Listen to voice mail
- 7 Info message
- 8 Templates
- 9 Settings

6 My stuff



- 1 Photos
- 2 Pictures
- 3 Silent movie
- 4 Sounds
- 5 Music
- 6 Others
- 7 External memory

7 Display



- 1 Wallpaper
- 2 Menu colour
- 3 Greeting note
- 4 Backlight
- 5 Information window

8 Profiles



- 1 General
- 2 Silent
- 3 Vibrate only
- 4 Loud
- 5 Headset
- 6 Car

9 Tools



- 1 Favorites
- 2 Alarm clock
- 3 Bluetooth
- 4 SyncML
- 5 Calculator
- 6 Unit converter
- 7 World time
- 8 SIM-Menu

* Browser



- 1 Home
- 2 Bookmarks
- 3 Go to URL
- 4 Settings
- 5 Browser version

0 Call register



- 1 Missed calls
- 2 Received calls
- 3 Dialed calls
- 4 All calls
- 5 Delete recent calls
- 6 Call charges
- 7 GPRS information

Settings



- 1 Date & Time
- 2 Languages
- 3 Call settings
- 4 Security settings
- 5 Network settings
- 6 GPRS settings
- 7 Memory status
- 8 Reset settings

Games & more

[Menu 1-1]

- **Default Games:** In this menu, you can manage the Java applications installed in your phone. You can play or delete downloaded applications, or set the connect option. The downloaded applications are organised in folders. Press the left soft key  [Menu] to open the selected folder or launch the selected midlet.
 - ▶ **Launch:** Start the selected application.
 - ▶ **Info:** Shows the information of the application.
 - ▶ **Options:** Some Java applications may require a data connection to be made.
 - **Note** You cannot remove or rename the preinstalled folder or a game in the folder.

Settings

[Menu 1-2]

You can set the network settings to download the game.

- ▶ **Activate:** You can activate the selected internet.
- ▶ **Settings:** You can set the value of bearer, proxy and DNS.
- ▶ **Rename:** You can change the name of internet.









Java™, is a technology developed by Sun Microsystems. Similar to the way you would download the Java Applet using the standard Netscape or MS Internet Explorer browsers, Java MIDlet can be downloaded using the WAP enabled phone. Depending on the service provider, all Java based programs such as Java games can be downloaded and run on a phone. Once downloaded, the Java program can be viewed in the **My games & more** menu where you can select, execute, or delete. The Java program files saved in the phone are in .JAD or .JAR format.

- **Note**
 - The JAR file is a compressed format of the Java program and the JAD file is a description file that includes all detailed information. From the network, prior to download, you can view all detailed file descriptions from the JAD file.
 - While being based on a standard language (J2ME), not all Java applications are compatible with all handsets on sale insofar as specific libraries may be used for a telephone model. The software may be blocked or switch itself on when Java applications not specifically developed for the phone this manual refers to are downloaded, making it necessary to “restart” the handset. We would like to point out that these problems are caused by incompatible applications and are not a product fault.
- **Caution** Only J2ME(Java 2 Micro Edition) based programs will run in a phone environment. The J2SE(Java 2 Standard Edition) based programs will only run in a PC environment.

Add new

[Menu 2-1]

You can add phonebook entry by using this function. Phone memory capacity is 250 entries. SIM card memory capacity depends on the cellular service provider. You can also save 20 characters of name in the Phone memory, and save characters in the SIM card. The number of character is SIM dependent feature.

1. Select **Add new** by press left soft key  [Select] or [OK].
2. Select the memory you want to save: **SIM** or **Phone**. If you set to Phone, you need to select which number you want as a main number.
 - a. Press  [Save] to input a name.
 - b. Press  [Save], then you can input a number.
 - c. Press  [Save] to input e-mail address.
 - d. You can set a group for the entry by pressing , .
 - e. You can set a character and a picture for the entry by pressing , .

Search



[Menu 2-2]



1. Select **Search** by press the left soft key  [Select] or [OK].
2. Enter the name that you want to search.
 - **Note** Instant searching is available by inputting the initial letter of the name or number you want to search.
3. If you want to edit, delete, copy an entry, or to add the voice to one, select left soft key [Options]. The following menu will be displayed.
 - ▶ **View detail:** You can view the entry saved in SIM or phone memory in details.
 - ▶ **Delete:** You can delete an entry.
 - ▶ **Write messages:** After you have found the number you want, you can send a text/multimedia message to the selected number.
 - ▶ **Send via bluetooth:** After setting **On** in bluetooth, you can send the phonebook list via bluetooth.
 - ▶ **Edit:** You can edit the name, number, group, character and picture by using the navigation key.
 - ▶ **Copy to handset/ SIM:** You can move the entry from SIM to phone or phone to SIM.
 - ▶ **Assign speed dial:** You can assign the entry as a speed dial.
 - ▶ **View caller groups:** You can view the entry which is assigned in each caller group.

Contacts [Menu 2]

Speed dial

[Menu 2-3]

You can assign any of the keys  to  with a Name list entry. You can call directly by pressing this key.

1. Open the phonebook first by pressing the right soft key  [Contacts] in standby mode.
2. Scroll to **Speed dial**, then press the left soft key  [Select].
3. If you want to add speed dial, select **(empty)**. Then, you can search the name in phonebook.
4. After assigning the number as speed dial, you can change and delete the entry. You can also make a call or send a message by this number.

Caller groups

[Menu 2-4]

You can list up to the 20 members per each group. There are 7 groups you can make lists to.

- ▶ **Member list:** Shows the group members you have selected.
- ▶ **Group ring tone:** Allows you to specify ring tone for the group members' call.
- ▶ **Group icon:** Allows you to select the icon dependent on Group.
- ▶ **Add member:** You can add group members. Each group member shouldn't be exceeded 20.
- ▶ **Remove member:** You can remove the member from the Group member list. But the name and the number will be remained in phonebook.
- ▶ **Rename:** You can change a group name.
- ▶ **Remove all:** You can remove all entries from the phonebook.

Own number (SIM dependent) [Menu 2-5]

You can save and check your own number in SIM card.

Settings

[Menu 2-6]

1. Press the right soft key  [Contacts] in standby mode.
2. Scroll to **Settings**, then press the left soft key  [Select].



► **View options**

Scroll to highlight **View options**, and then press the left soft key

- **Name only:** Set the phonebook list with displaying only name.
- **Name and number:** Set the phonebook list with displaying name and number.
- **With picture:** Set the phonebook list with the information of character and picture.

► **Copy all**

You can copy/move entries from SIM card memory to Phone memory and vice versa.

1. Open the Phonebook first by pressing the right soft key  [Contacts] in standby mode.
2. Scroll to **Copy all**, and then press the left soft key  [Select] to enter this menu.

- **SIM to handset:** You can copy the entry from SIM Card to Phone memory.
- **Handset to SIM:** You can copy the entry from Phone memory to SIM Card.



► **Move all:** You can move all entries from SIM to phone or phone to SIM.

► **Default memory**

Scroll to highlight **Default memory**, and then press the left soft key  [Select]. If you select **SIM** or **Phone**, the phone will store an entry to SIM or phone.





► **Memory in use**

This feature allows you to see how many free and in-use are in your phonebook.

1. Open the phonebook first by pressing the right soft key  [Contacts] in standby mode.
2. Scroll to **Memory in use**, then press the left soft key  [OK].

► **Clear contacts**





You can delete all entries in SIM and Handset. This function requires Security code.

- Press the right soft key  [Contacts] in standby mode and select **Clear contacts**, press  [Select].
- Then select a memory to erase.
- Enter security code and press the left soft key  [OK] or the right soft key  [Back].

► **Business card:** You can create business card.

► **Service dial number**

Use this function to access a particular list of services provided by your network operator (if supported by the SIM card).





1. Open the phonebook first by pressing the right soft key  [Contacts] in standby mode and select **Settings**.
2. Scroll to **Service dial number**, then press the left soft key  [Select] to enter.
3. The names of the available services will be shown.
4. Use  and  to select a service. Press  [Send].

Calendar

[Menu 3-1]

When you enter this menu a calendar will show up. On top of the screen there are sections for date. Whenever you change the date, the calendar will be updated according to the date. And square cursor will be used to locate the certain day. If you see under bar on the calendar, it means that there is a schedule or memo that day. This function helps to remind you of your schedule and memo. The phone will sound an alarm tone if you set this for the note.

To change the day, month, and year.

	Description		Description
	Yearly		Weekly
	Monthly		Daily

In the scheduler mode, press left soft key  [Options] as follows;



Add new



[Menu 3-1-1]

Allows you to add new schedule and memo for the chosen day. You can store up to 20 notes. Input the subject and then press left soft key  [OK]. You enter the appropriate information in the follow section; **Time, Repeat** and Alarm.

View daily schedules

[Menu 3-1-2]

View all schedules and memo for the chosen day. Use ,  to browse through the note lists. If you set alarm for the note, the alarm icon is displayed.

If you want to view the note in detail, press left soft key  [Select]. Press left soft key  [Options] to delete, edit the note you selected.

Delete past [Menu 3-1-3]

You can delete the past schedule that has been already notified you.

Delete all [Menu 3-1-4]

You can delete all the notes.



Go to date [Menu 3-1-5]

You can go to the chosen date directly.

Set alarm tone [Menu 3-1-6]

You can set an alarm tone of each chosen date.

Memo [Menu 3-2]





1. Select the **Memo** by pressing the left soft key  [Select].
2. If the entry is empty, press the left soft key  [Write].
3. Input the memo and then press left soft key  [OK].

● **Note** If you want to change the text input mode, press the  in order.





You can enjoy your multimedia function such as camera, voice recorder, MP3 for your fun and convenience.







Take photo [Menu 4-1]

• To take a picture with Folder opened

1. Select **Take photo**, and then press . If you want to reach this menu directly, press  for a long time.
2. Focus on the subject to capture the image, and then press the  key.
3. If you want to save it, press the left soft key  or the  key.



❗ **Note** You can control the image size, brightness, colour and zooming by pressing the navigation key ( or ).

- ▶ **Resolution** []: Allows you to set the image size to one of Hi (1280X960), Med (640x480), Low (320x240) main screen, contact, and front screen.
- ▶ **Picture quality** []: Allows you to set the image quality to Standard, Superfine or Fine.
- ▶ **Flash** []: Allow you to set the flash when you take a photo in dark place.
- ▶ **Multishot** []: Allows to take a multishot photos successively.
- ▶ **Zoom** []: Allows you to set the zooming value from x1 to x2 depends on resolution.

- ▶ **Brightness** []: Use the right/left navigation keys to adjust brightness. 9 lighting levels are available: -2.0, -1.5, -1.0, -0.5, 0.0, +0.5, +1.0, +1.5, +2.0.
- ▶ **Lighting settings** []: Allows you to change the settings according to the environment.
- ▶ **Night time** []: Allows you to take a picture by using this menu at night.
- ▶ **Autoshoot** []: Allows you to select the delay time (None, 3 Seconds, 5 Seconds, 10 seconds). Then the phone takes a photo after the specified time.
- ▶ **Colour** []: 3 settings are available: Color, Sepia, Black/White.
- ▶ **Memory status** []: Check the available memory to take new pictures.

• To take a picture with Folder closed



You can see yourself by sub LCD, when you take your self-portrait.

1. Press [] for a long time.
 2. Focus on the subject to capture the image, and then press []. This time, the picture is saved automatically.
- **Camera:** Activate the Take photo mode.
 - **Slide show:** View the pictures in Album as slide show.
 - **Torch:** Activate the flash light.
 - **Back:** Go back to the previous menu.

After finishing all the setting, focus on the subject to capture and press the Camera key or OK key. With a click, the image is captured and the following menu bar appears.



Fun frames [Menu 4-2]

You can take a picture on the various of back-grounds. Furthermore, you can select a frame by pressing the navigation key  or .

Note In this mode, you can't change the settings of resolution.

• Options

- ▶ **Full view:** You can view full photo.
- ▶ **Set as wallpaper:** You can set a picture as a wallpaper.
- ▶ **Send via multimedia message:** You can send a picture thru MMS.
- ▶ **Send via bluetooth:** You can send the photo by bluetooth.
- ▶ **Copy/Move to external memory:** You can copy or move between phone and the SD memory.
- ▶ **Rename:** You can edit the title of picture.
- ▶ **Delete:** You can delete a photo.
- ▶ **Information:** You can view the information about

Title, Size, Date and Time of the picture you've taken.

Take silent movie [Menu 4-3]

You can record video streaming for 20 seconds.

1. Select **Take silent movie** menu.
2. If you want to record the movie, press the left soft key [Record].
3. You can check the remaining time by time bar.



Voice recorder [Menu 4-4]

The voice memo feature you to record up to 10 voice messages and each memo is up to 60 Seconds.

Note The default setting for recording time is 30 seconds, but you can select 30 secs or 1 min in settings menu.

Record [Menu 4-4-1]

You can record voice memo in Voice recorder menu.

1. Once recording is started, the message Recording and the remaining time is displayed.
2. If you want to finish recording, press the left soft key  [Save].
3. Key in Voice memo title, press the left soft key  [OK].

View list

[Menu 4-4-2]

The phone shows voice memo list. You can playback and delete the recorded voice memo.

- ▶ **Play:** Allows to listen to the recorded voice memo.
- ▶ **Record new:** Allows to record new voice memo.
- ▶ **Send via message:** Allows to send the multimedia message or bluetooth with voice memo.
- ▶ **Delete:** Allows to delete voice memo.
- ▶ **Delete all:** Allows to delete all voice memos.

MP3

[Menu 4-5]

The M4410 has an integrated MP3 player built-in. You can enjoy listening to MP3 music files on a memory in your phone using a compatible headset or via the internal loudspeaker.

- **Note** Because of the small dimension of the speaker, in some cases the audio could be distorted, especially at maximum volume and when there are lots of bass sounds. Therefore, we recommend you to use the stereo headset in order to appreciate the high quality of your music.

The music player supports:

- **MPEG-1 Layer III:** Sampling frequency up to 48KHz, Bit rate from 32Kbps up to 192Kbps, stereo
- **MPEG-2 Layer III:** Sampling frequency up to 24KHz, Bit rate from 32Kbps up to 160Kbps, stereo
- **AAC:** ADIF, ADTS formats (Sampling frequency up to 48KHz)
- **Note** M4410 doesn't support the variable rate of MP3 and AAC file. Therefore, you can't change the file from VBR MP3 format to AAC.

You can transfer MP3 files from a compatible PC to the memory in your phone using the LG Contents Bank on the CD-ROM in the sales package.

When you connect the phone to a PC using the USB cable(supplied in the same package), you need to install a driver. For further details, refer to the CD-ROM manual.

Multimedia [Menu 4]

- **Note** • The PC should run Windows 98 SE, Windows ME, Windows 2000, Windows XP operating system.
- Besides downloading the MP3 files to the phone, you can upload the pictures taken on the phone to the PC using the USB cable. And you can also manage the phonebook, scheduler, and Memo on the PC. Consult with the authorised dealer for availability of accessories.
- To download MP3 file in Windows 2000, you should set folder option in PC as follow: View WEB -> Use Windows default folder (I).

MP3 player

[Menu 4-5-1]

1. Press MP3 menu, and then select MP3 player.
 2. Press the left soft key  [Options] to access the following menus.
- ▶ **Main LCD skin:** This menu allows to change the backgroud of main LCD on playing MP3 file.
 - ▶ **Front LCD skin:** This menu allows to change the backgroud of front LCD on playing MP3 file with closing a folder.
 - ▶ **Equalizer**
This menu helps you to adjust various of environment on listening to the music. This phone supports four preset menus. When you enter this menu, you can view current value of equalizer.

▶ Flip setting:

• Continue playing

Although you close the flip on playing, the play mode is continued without a pause.

• Stop playing

When you close the flip, you can stop the play mode.

▶ View play list

You can view the play list on listening to the music.

▶ Playmode

This menu allows to set the play mode: Play all, Repeat all, Random all, Play one and Repeat one.

▶ Set as ring tone

This menu allows to set the MP3 file as a ring tone. You can also set it as a ring tone in Profile.

Play list

[Menu 4-5-2]

This menu allows to view the whole play list. You can move the track by pressing the navigation key. In addition, if you select option menu, you can delete the file or view its information .

My photos

[Menu 4-6]

You can view and send a picture. In addition, you can set the picture as a background.

All photos

[Menu 4-6-1]

You can view all pictures in order.

General photos

[Menu 4-6-2]

You can view all pictures except of frame and phone book ones.

Mode photos

[Menu 4-6-3]

You can view all frame pictures.

Contacts photos

[Menu 4-6-4]

You can view all contacts photos.

- ▶ **Full view:** You can view full photo.
- ▶ **Set as wallpaper:** You can set a picture as a wallpaper.
- ▶ **Send via multimedia message:** You can send a picture thru MMS.
- ▶ **Send via bluetooth:** You can send the photo by bluetooth.
- ▶ **Copy/ Move to external memory:** You can copy or move any picture between phone and the SD memory.

- ▶ **Rename:** You can edit the title of picture.
- ▶ **Delete:** You can delete the photo.
- ▶ **Information:** You can view the information about Title, Size, Date and Time of the picture you've taken.

Silent movie

[Menu 4-7]

This menu allows to play or delete the video file. You can change the name of file, and check information related to size and time.

- ▶ **Play:** You can play the streaming file.
- ▶ **Delete:** You can delete the streaming file.
- ▶ **Delete all:** You can delete all the streaming files.
- ▶ **Rename:** You can change the name of streaming file.
- ▶ **Information:** You can view information of file.

Settings

[Menu 4-8]

Camera

[Menu 4-8-1]

- ▶ **Auto save:** If you set this option **On**, the images will be saved automatically without displaying menu bar to save.
- ▶ **Shutter tone:** You can change the shutter tone to take a picture.

Multimedia [Menu 4]

- ▶ **Delete all photos:** This menu allows to delete all photos after asking your confirmation.

Voice recorder [Menu 4-8-2]

- ▶ **Duration:** You can set the duration to record for 30 seconds or 1 minute for recording.

Memory in use [Menu 4-8-3]

You can check the capacity of memory in use.

New message

[Menu 5-1]

This menu includes functions related to SMS (Short Message Service), MMS (Multimedia Message Service), voice mail, as well as the network's service messages.

Text message

[Menu 5-1-1]

You can write and edit text messages, checking the number of message pages.



1. Enter the **Messages** menu by pressing the left soft key  [Select].
2. If you want to write a new message, select **Text message**.
3. To make text input easier, use T9.
4. Press [Insert] to attach the followings.

Insert

- ▶ **Picture:** You can insert the Default graphics or graphics in My pictures that are available for short messages.
- ▶ **Sound:** You can insert sounds that are available for short messages.
- ▶ **Text templates:** You can use Text templates already set in the phone.
- ▶ **Contacts:** You can add phone numbers or e-mail addresses in address book.

- ▶ **Symbol:** You can add special characters.
 - ▶ **Business card:** You can add your signature to the message.
 - ▶ **Schedule:** You can insert your own schedule on writing the message.
5. If you want to set option for your text, or to finish your writing, press the left soft key  [Options].

Options

- ▶ **Send:** Sends text messages.
 1. Enter numbers of recipient.
 2. Press  key to add more recipients.
 3. You can add phone numbers in the address book.
 4. Press the left soft key  after entering numbers.
All messages will be automatically saved in the outbox folder, even after a sending failure.
- ▶ **Save to drafts:** Saves messages in Drafts.
- ▶ **Font & Alignment:** You can select **Size** and **Style** of fonts, and the alignment of text.
- ▶ **Colour:** You can select **Colour** of foreground and background.
- ▶ **T9 dictionary:** You can add your own word. This menu can be shown only when edit mode is Predictive (T9Abc/T9abc/T9ABC).
- ▶ **Exit:** If you press **Exit** while writing a message, you can end the writing message and back to the Message

Messages [Menu 5]

menu. The message you have written is not saved.

- **Note** The phone which supports EMS release 5 is available to send colour pictures, sounds, text styles, etc.. The other party may not receive pictures, sounds or text styles you sent properly if the phone does not support such options.

Multimedia message [Menu 5-1-2]

You can write and edit multimedia messages, checking message size.

1. Enter the **Message** menu by pressing the left soft key  [Select].
2. If you want to write a new message, select **Multimedia message**.
3. You can create a new message or choose one of the multimedia message templates already made.
4. Press **Insert** to add photos, pictures, sounds, record voice, text templates, contacts, symbol, business card, and schedule.

Options

- ▶ **Send:** You can send multimedia messages to multiple recipients, prioritize your message, and make it sent later as well.
- **Note** All messages will be automatically saved in the outbox folder, even after a sending failure.
- ▶ **Preview:** You can preview multimedia messages







you wrote.

- ▶ **Save:** You can save multimedia messages **To drafts** or **As template**.
- ▶ **Edit subject:** You can edit the subject of each message.
- ▶ **Add slide:** You can add a slide before or after current slide.
- ▶ **Move to slide:** You can move to previous or next slide.
- ▶ **Delete slide:** You can delete current slides.
- ▶ **Set slide format**
 - **Set timer:** You can set timer for slide, text, picture and sound.
 - **Set colour:** You can set the color of foreground or background.
- ▶ **T9 dictionary:** You can add your own word. This menu can be shown only when edit mode is Predictive (T9Abc/T9abc/T9ABC).
- ▶ **Exit:** You can get back to the Message menu.
- **Note** If you select the picture (15K) on writing multimedia message, loading duration will take around 15 seconds at least. Furthermore, you can't activate any key during loading time. After 15 seconds, it is available to write multimedia message.

Inbox

[Menu 5-2]

You will be alerted when you have received messages. They will be stored in Inbox. In Inbox, you can identify each message by icons. For detail, see the icon directive.

	Icon directive
	Multimedia message
	Short message
	SIM message
	Read multimedia message
	Read text message
	Push message
	Notified multimedia message

If the phone shows 'No space for SIM message', you have to delete only SIM messages from Inbox. If the phone displays 'No space for message', you can make space of each repository as deleting messages, media and applications.

* SIM message

SIM message means the message exceptionally stored in SIM card. You can move this message to the phone.

For notified multimedia message, you have to wait for downloading and processing of the message.





To read a message, select one of the messages by pressing the left soft key .

- ▶ **View:** You can view the received messages.
- ▶ **Reply:** You can reply to the sender.
- ▶ **Forward:** You can forward the selected message to another party.
- ▶ **Return call:** You can call back to the sender.
- ▶ **Delete:** You can delete the current message.
- ▶ **Information:** You can view information about received messages; Sender's address, Subject (only for Multimedia message), Message date & time, Message type, Message size.
- ▶ **Delete all:** You can delete all messages.

Outbox

[Menu 5-3]

This menu allows to view the message which is about to send or is failed sending. After sending the message successfully, the message will be moved to sent menu.



	Icon directive
	MMS Unsent
	MMS delivery confirmed
	SMS unsent
	SMS delivery confirmed

- ▶ **View:** You can view the message.
- ▶ **Edit:** You can edit the message.
- ▶ **Send:** You can send the message. After sending the message, this will be moved to sent menu.
- ▶ **Delete:** You can delete the message.
- ▶ **Information:** You can check information of each message.
- ▶ **Send all:** You can send all messages from outbox.
- ▶ **Delete all:** You can delete all messages from outbox.

Sent

[Menu 5-4]

You can view the message which is already sent.

	Icon directive
	MMS Sent
	SMS sent

- ▶ **View:** You can view the sent messages.
- ▶ **Forward:** You can forward the current message to other recipients.
- ▶ **Delete:** You can delete the current message.
- ▶ **Information:** You can view information about outbox messages; Recipient's address, Subject (only for Multimedia message), Message date & time, Message type, Message size.
- ▶ **Delete all:** You can delete all the earlier sent messages.

Drafts

[Menu 5-5]



Using this menu, you can preset up to five multimedia messages that you use most frequently. This menu shows the preset multimedia message list.

The following options are available.

- ▶ **View:** You can see the multimedia messages.
- ▶ **Edit:** Modifies the message you choose.

- ▶ **Delete:** Deletes the message you choose.
- ▶ **Information:** To view the information of the message.
- ▶ **Delete all:** Deletes all of the messages in the folder.

Listen to voice mail [Menu 5-6]

Once this menu has been selected, simply press the left soft key  [OK] to listen to voice mail. You can also hold down the  key in standby mode to listen to voice mail.



- **Note** When you receive a voice mail, your phone displays the icon and you hear an alert. Please check with your network provider for details of their service in order to configure the handset correctly.

Info message [Menu 5-7]

(Dependent to network and subscription)

Info service messages are text messages delivered by the network to GSM. They provide general information such as weather reports, traffic news, taxis, pharmacies, and stock prices. Each type has the number; therefore, you can contact service provider as long as you have input the certain number for the information. When you have received an info service message, you can see the popup message to show you that you have received a message or the info service message is directly displayed. To view the message again or not in standby mode, follow the sequence shown below;

Read [Menu 5-7-1]

1. When you have received an info service message and select Read to view the message, it will be displayed on the screen. You can read another message by scrolling , , or  [Next].
2. The message will be shown until another message is reached.

Topics [Menu 5-7-2]

(Dependent to network and subscription)

- ▶ **Add new:** You can add Info service message numbers in the Phone memory with its nickname.
- ▶ **View list:** You can see Info service message numbers which you added. If you press  [Options], you can edit and delete info message category which you added.
- ▶ **Active list:** You can select info service message numbers in the active list. if you activate an info service number, you can receive messages sent from that number.

Messages [Menu 5]

Templates

[Menu 5-8]

Text template

[Menu 5-8-1]

You have 6 text templates as below;

- **Please call me back**
- **I'm late. I will be there at**
- **Where are you now?**
- **I am on the way.**
- **Top urgent. Please contact.**
- **I love you.**

Multimedia template

[Menu 5-8-2]

After saving new template, you can use the following options.

- ▶ **View:** You can see multimedia templates.
- ▶ **Delete:** You can delete multimedia templates.
- ▶ **Add new:** Allows you to add new multimedia templates.
- ▶ **Send via multimedia message:** You can write and send multimedia messages.
- ▶ **Edit:** You can edit multimedia templates.
- ▶ **Delete all:** Allows you to delete all multimedia messages.

Settings

[Menu 5-9]

Text message

[Menu 5-9-1]

▶ **Message types:**

Text, Voice, Fax, Natl. paging, X.400, E-mail, ERMES

Usually, the type of message is set to **Text**. You can convert your text into alternative formats. Contact your service provider for the availability of this function.

- ▶ **Validity period:** This network service allows you to set how long your text messages will be stored at the message centre.

- ▶ **Delivery report:** If you set to **Yes**, you can check whether your message is sent successfully.

- ▶ **Reply charging:** When a message is sent, it allows the recipients to reply and charge the cost of the reply to your telephone bill.

- ▶ **SMS centre:** If you want to send the text message, you can receive the address of SMS centre through this menu.

Multimedia message

[Menu 5-9-2]

- ▶ **Priority:** You can set the priority of the message you choose.
- ▶ **Validity period:** This network service allows you to set how long your text messages will be stored at the message centre.
- ▶ **Subject:** You can insert the subject of each template.

- ▶ **Delivery report:** If it is set to **Yes** in this menu, you can check whether your message is sent successfully.
- ▶ **Read reply:** You can send the reply for the confirmation whether you read the message or not.
- ▶ **Auto download:** If you select **On**, you receive multimedia messages automatically. If you select **Off**, you receive only notification message in the inbox and then you can check this notification. If you select **Home network only**, you receive multimedia messages depends on Homenetwork.
- ▶ **Network settings:** If you select multimedia message server, you can set URL for multimedia message server.
- ▶ **Permitted types**
 - Personal:** Personal message.
 - Advertisements:** Commercial message.
 - Information:** Necessary information.

Voice mail centre [Menu 5-9-3]

You can receive the voicemail if your network service provider supports this feature. When a new voicemail is arrived, the symbol will be displayed on the screen. Please check with your network service provider for details of their service in order to configure the phone accordingly.

- ▶ **Home:** You can listen to voice mails by selecting Home.
- ▶ **Roaming:** Even when you are in abroad, you can listen

to voice mails if roaming service is supported.

Info message [Menu 5-9-4]

- ▶ **Receive**
 - Yes:** If you select this menu, your phone will receive Info service messages.
 - No:** If you select this menu, your phone will not receive Info service messages any more.
- ▶ **Alert**
 - Yes:** Your phone will beep when you have received Info service message numbers.
 - No:** Your phone will not beep even though you have received info service messages.
- ▶ **Languages**

You can select the language you want by pressing [On/Off]. Then, the info service message will be shown in the language that you selected.

Push message [Menu 5-9-5]

You have the following options :

1. Receive on / off
2. Autodownload on / off

My stuff [Menu 6]

Photos

[Menu 6-1]

After taking a picture, you can view or send it by MMS and bluetooth. Press the left key [Options] to enter the options.

- ▶ **Full view:** You can view full photo.
- ▶ **Multi view:** You can view the maximum of 9 thumbnails in a screen.
- ▶ **Set as wallpaper:** You can set a picture as a wallpaper.
- ▶ **Send via multimedia message:** You can send a picture through MMS.
- ▶ **Send via bluetooth:** You can send the photo by bluetooth.
- ▶ **Copy/ Move to external memory:** You can copy or move between phone and the SD memory.
- ▶ **Rename:** You can edit the title of picture.
- ▶ **Delete:** You can delete the photo.
- ▶ **Information:** You can view the information about Title, Size, Date and Time you've taken.

Pictures

[Menu 6-2]

After selecting a picture, press the left key [View]. You can check the options as follow:

- ▶ **Set as wallpaper:** Currently selected picture can be set as a wallpaper.

- ▶ **Send via multimedia message:** The picture downloaded from network can be sent by MMS service.
- ▶ **Send via bluetooth:** The picture downloaded from network can be sent by Bluetooth.
- ▶ **Copy to external memory:** The picture can be moved to Mini SD memory card.

Silent movie

[Menu 6-3]

You have the following options :

- ▶ **Play:** You can play the streaming file.
- ▶ **Delete:** You can delete the streaming file.
- ▶ **Delete all:** You can delete all the streaming files.
- ▶ **Rename:** You can change the name of streaming file.
- ▶ **Information:** You can view information of file.

Sounds

[Menu 6-4]

After selecting a sound, press the left key [Options]. You can check the options as follow:

- ▶ **Set as ringtone:** Currently selected sound can be set as a ringtone.
- ▶ **Send via text/ multimedia message:** The sound downloaded from network can be sent by SMS or MMS service.
- ▶ **Send via bluetooth:** The sound downloaded from

network can be sent by Bluetooth.

- ▶ **Copy to external memory:** The sound can be moved to Mini SD memory card.

Music

[Menu 6-5]

You can download MP3 file from network, and then you can enjoy the music. In addition, you have the following options :

- ▶ **Play:** You can play MP3 file.
- ▶ **Play list:** You can view the play list of music.
- ▶ **Set as ringtone:** You can set the MP3 file as ringtone.
- ▶ **Delete:** You can delete the file.

Others

[Menu 6-6]

This menu provides a space to store the external files which are not opened on this phone.

External Memory

[Menu 6-7]

This menu allows you to view Photos, Pictures, Sounds and Music in Mini SD memory card. If the external memory is not available, a pop up message "Please insert external memory" is displayed.

You can set functions relating to the phone.



Wallpaper [Menu 7-1]

You can select the background pictures in standby mode.

Main LCD [Menu 7-1-1]

Front LCD [Menu 7-1-2]

Preinstalled

You can select a picture or an animation of wallpaper by pressing  or .

My pictures

You can select a picture or an animation as wallpaper.

Menu colour [Menu 7-2]

Your phone provides you with 4 menu colour themes. Set the menu colour by scrolling and pressing the left soft key [Select].

Greeting note [Menu 7-3]

If you select **On**, you can edit the text which is displayed in standby mode.

Backlight [Menu 7-4]

You can set the light-up duration of the display.

Information window [Menu 7-5]

You can preview the current state of the selected menu before open the menu. The state is shown at bottom of the display.

In Profiles, you can adjust and customise the phone tones for different events, environments or caller groups. There are six preset profiles: **General**, **Silent**, **Vibrate only**, **Loud**, **Headset** and **Car**. Each profile can be personalised. Press the left soft key [Menu] and select **Profiles** using up/down navigation keys.

Activate [Menu 8-X-1]

1. A list of profiles is displayed.
2. In the Profiles list, scroll to the profile you want to activate and press the left soft key  [Select] or OK key.
3. Then, select Activate.

Personalise [Menu 8-X-2]

Scroll to the desired profile in the Profile list. After pressing the left soft key  or the OK key, select **Personalise**. The profile setting option opens. Set the option as required.



- ▶ **Call alert type:** Set the alert type for incoming calls.
- ▶ **Ring tone:** Select the desired ring tone from the list.
- ▶ **Ring volume:** Set the volume of the ringing tone.
- ▶ **Message alert type:** Set the alert type for messages.
- ▶ **Message tone:** Select the alert tone for messages.
- ▶ **Keypad tone:** Select the desired keypad tone.
- ▶ **Flip tone:** Allows to set the flip tone for adjusting environment.

- ▶ **Keypad volume:** Set the volume of keypad tone.
- ▶ **Sound effects volume:** Set the volume of effect sound.
- ▶ **Power on/off volume:** Set the volume of the ringing tone when switching the phone on/off.
- ▶ **Auto answer:** This function will be activated only when your phone is connected to the handsfree kit.
 - **Off:** The phone will not answer automatically.
 - **After 5 secs:** After 5 seconds, the phone will answer automatically.
 - **After 10 secs:** After 10 seconds, the phone will answer automatically.

Rename [Menu 8-X-3]

You can rename a profile and give it any name you want.

❶ **Note** **Vibrate only**, **Silent** and **Headset** profiles cannot be renamed.

1. To change the name of a profile, scroll to the profile in the profile list and after pressing the left soft key  or the OK key, select **Rename**.
2. Key in the desired name and press the OK key or the left soft key  [OK].

Tools [Menu 9]

Favourites



[Menu 9-1]

This option allows you to add your own favourites to the list already provided. Once you create your own menu, you can access the desired function quickly in the idle screen by pressing the up navigation key.

Alarm clock

[Menu 9-2]

You can set up to 5 alarm clocks to go off at a specified time.

1. Select **On** and enter the alarm time you want.
2. Select the repeat period: **Once, Mon~Fri, Mon~Sat, Everyday.**
3. Select the alarm tone you want and press  [OK].
4. Edit the alarm name and press  [OK].

Bluetooth

[Menu 9-3]

Bluetooth enables compatible mobile devices, peripherals and computers that are in close proximity to communicate directly with each other without wires. This handset supports built-in Bluetooth connectivity, which makes it possible to connect them with compatible Bluetooth headsets, computer applications and so on.

📌 **Note** You can exchange the data within only phonebook via bluetooth.

My devices

[Menu 9-3-1]

You can view all devices which are compatible with bluetooth phone.

Handsfree devices

[Menu 9-3-2]

You can view the list of handsfree devices which is compatible with bluetooth phone.

If you enter My devices or Handsfree devices menu, you access the options as follow.

- ▶ **Connect/ Disconnect:** Allows to connect the other bluetooth devices.
- ▶ **Add new:** Allows to search new bluetooth device.
- ▶ **Assign name:** Allows to change the name of bluetooth.
- ▶ **Set as authorised/Set as unauthorised:** Allows to set the authorised connection between each bluetooth devices.
- ▶ **All service:** Allows to view all services which are supported by bluetooth device.
- ▶ **Delete :** Allows to delete the bluetooth device.
- ▶ **Delete all:** Allows to delete all bluetooth devices.

Settings

[Menu 9-3-3]

You can register new device which is compatible with bluetooth. If you already have added the device, you can search it after entering a password.

▶ Set bluetooth

You can activate or cancel bluetooth function.

▶ Handset's visibility

You can set the function that your phone is shown on the other bluetooth devices.

▶ Handset's name

You can set the name of bluetooth device. The default name is M4410.

SyncML

[Menu 9-4]

The SyncML function synchronises the data in a phone and the data on a server such as contact address information, schedule items, etc. via a wireless network.

• Connect

Select SyncML from the Connectivity menu and then press the **OK** key.

Select the Connect item and then press the **OK** key. Connect to the server with the selected server profile and the synchronization animation is displayed while the synchronization is performed.

• Server settings

This menu allows you to configure the profile for a SyncML.

▶ Adding a new profile

- Input and choose the Profile name, Host address, Username, Password, Contacts, Contact name, Calendar, Calendar name, To do, To do name and Access point.
- Press the **OK** key to save the new profile.
- In the Settings screen, press the left soft key [Options] key and select Add new to add a new profile.

▶ Editing a profile

- Select a profile to edit.
- Press the left soft key [Options], select Edit, and edit the selected profile.

▶ Deleting profiles

- Press the left soft key [Options] and select Delete.
- Select Yes to delete the selected profile.

▶ Selecting a server

- Select a desired server profile to synchronise in the Settings screen and then press the **OK** key.

• Logs





Select a SyncML item in the Connectivity menu and then press the **OK** key.

Select Logs item and then press the **OK** key to view the log for the last synchronisation operation performed.

Calculator

[Menu 9-5]



This contains the standard functions such as +, −, ×, ÷ : **Addition, Subtraction, Multiplication, and Division.** Furthermore, you can use the various function of calculator such as **sin, cos, log.**

1. Input the numbers by pressing numeric keys.
2. Use a navigation key to select a sign for calculation.
3. Then input the numbers.
4. Press  key to view the result.
5. If you press the left soft key  [Function], you can use the various of calculation.
6. To input the decimal number, press  key. If you press  key, you can enter ().
7. To end **Calculator**, press the right soft key  [Back].

Unit converter

[Menu 9-6]

This converts any measurement into a unit you want. There are 7 types that can be converted into units: **Currency, Surface, Length, Weight, Temperature, Volume and Velocity.**



1. You can select one of four unit types by pressing  [Unit] key.
2. Select the unit you want to convert by pressing  and .

3. Select the standard value by using , .

World time

[Menu 9-7]

You can view clocks of the world's major cities.

1. Select the city belonged to the time zone by pressing ,  key.
2. You can set the current time to the city time you select by pressing the left soft key  [Set].

SIM-Menu

[Menu 9-8]

This menu depends on SIM and the network services.

You can access various WAP (Wireless Application Protocol) services such as banking, news, weather reports and flight information. These services are specially designed for mobile phones and they are maintained by WAP service providers.

Check the availability of WAP services, pricing and tariffs with your network operator and/or the service provider whose service you wish to use. Service providers will also give you instructions on how to use their services.



Once connected, the homepage is displayed. The content depends on the service provider. To exit the browser at any time, press the () key. The phone will return to the previous menu.

Navigating with the WAP browser

You can surf the Internet using either the phone keys or the WAP browser menu.

Using the phone keys

When surfing the Internet, the phone keys function differently to phone mode.

	Description
	Scrolls each line of the content area
	Returns to the previous page
	Selects options and confirms actions

Using the WAP browser menu

There are various menu options available when surfing the Mobile Web.

Note The WAP browser menus may vary, depending on your browser version.

Home

[Menu *-1]

Connects to a homepage. The homepage will be the site which is defined in the activated profile. It will be defined by the service provider if you have not defined it in the activated profile.

Bookmarks

[Menu *-2]

This menu allows you to store the URL of favourite web pages for easy access at a later time. Your phone has several pre-installed bookmarks. These pre-installed bookmarks cannot be deleted.

To create a bookmark

1. Press the left soft key  [Options].
2. Select Add new and press the OK key.
3. After entering the desired URL and title, press the OK key.

Browser [Menu *]

After selecting a desired bookmark, the following options are available.

- ▶ **Connect:** Connects to the selected bookmark.
- ▶ **Add new:** Select this to create a new bookmark.
- ▶ **Edit:** You can edit the URL and/or the title of the selected bookmark.
- ▶ **Delete:** Deletes the selected bookmark.
- ▶ **Delete all:** Deletes all the bookmarks.

Go to URL [Menu *-3]

You can connect directly to the site you want. After entering a specific URL, press the OK key.

Settings [Menu *-4]

You can set the profile, cache, cookie and security related to internet service.

Profiles [Menu *-4-1]

A profile is the network information used to connect to the Internet.

Each profile has submenus as follows:

- ▶ **Activate:** Activates the selected profile.
- ▶ **Settings:** Use this to edit and change WAP settings for the selected profile.
- **Homepage:** This setting allows you to enter the address (URL) of a site you want to use as homepage.

You do not need to type http:// at the front of each URL as the WAP Browser will automatically add it.

- **Bearer:** You can set the bearer data service.
1 Data / 2 GPRS
- **Data settings:** Appears only if you select Data Settings as a Bearer / service.
Dial number: Enter the telephone number to dial to access your WAP gateway.
User ID: The users identity for your dial-up server (and NOT the WAP gateway).
Password: The password required by your dial-up server (and NOT the WAP gateway) to identify you.
Call type: Select the type of data call : Analogue or Digital (ISDN).
Linger time: You need to enter timeout period. After entering that, the WAP navigation service will be unavailable if any data is not input or transferred.
- **GPRS settings:** The service settings are only available when GPRS is chosen as a bearer service.
APN: Input the APN of the GPRS.
User ID: The users identify for your APN server.
Password: The password required by your APN server.
- **Proxy settings**
Proxy: Activates or cancels proxy.
IP address: Input the IP address of the Proxy server you access.
Port number: Input the Proxy Port.

- DNS settings

Primary server: Input the IP address of the primary DNS server you access.

Secondary server: Input the IP address of the secondary DNS server you access.

▶ **Rename:** You can change the profile name.

▶ **Add new:** You can add a new profile.

▶ **Delete:** Deletes the selected profile from the list.

Cache

[Menu *-4-2]

The information or services you have accessed are saved in the cache memory of the phone.

Cookie

[Menu *-4-3]

The information or services you have accessed are saved in the cache memory of the phone.

Clear cache

[Menu *-4-4]

Removes all context saved in cache.

📌 **Note** A cache is a buffer memory, which is used to save data temporarily.

Clear cookie

[Menu *-4-5]

Removes all context saved in cookie.

Security

[Menu *-4-6]

A list of the available certification is shown.

▶ **Authority:** You can see the list of authority certificates that have been stored in your phone.

▶ **Personal:** You can see the list of personal certificates that have been stored in your phone.

Browser version

[Menu *-5]

The WAP browser version is displayed.

Call register [Menu 0]

You can check the record of missed, received, and dialled calls only if the network supports the Calling Line Identification (CLI) within the service area. The number and name (if available) are displayed together with the date and time at which the call was made. You can also view call times.

Missed calls [Menu 0-1]

This option lets you view the last 10 unanswered calls. You can also:

- View the number if available and call it, or save it in the Address Book
- Enter a new name for the number and save both in the Address Book
- Send a message by this number
- Delete the call from the list

Received calls [Menu 0-2]

This option lets you view the last 10 incoming calls. You can also:

- View the number if available and call it or save it in the Address Book
- Enter new name for the number and save both in the Address Book
- Send a message by this number
- Delete the call from the list

Dialled calls [Menu 0-3]

This option lets you view the last 20 outgoing calls (called or attempted). You can also view details, save, write messages, delete, Add to existing contacts and call these numbers.

- View the number if available and call it or save it in the Address Book
- Enter new name for the number and save both in the Address Book
- Send a message by this number
- Delete the call from the list

All calls [Menu 0-4]

This option allows you to view all records of call. You can also:

- View the number if available and call it, or save it in the Address Book
- Enter a new name for the number and save both in the Address Book
- Send a message by this number
- Delete the call from the list.

Delete recent calls [Menu 0-5]

Allows you to delete Missed calls and Received calls lists. You can delete Dialled calls and All calls lists at one time.

Call charges [Menu 0-6]

Call duration [Menu 0-6-1]

Allows you to view the duration of your incoming and outgoing calls. You can also reset the call times. The following timers are available:

- ▶ **Last call:** Length of the last call.
- ▶ **All calls:** Total length of all calls made and incoming calls since the timer was last reset.
- ▶ **Received calls:** Length of the incoming calls.
- ▶ **Dialled calls:** Length of the outgoing calls.
- ▶ **Reset all:** Allows you to clear the length of all calls by pressing the left soft key  [Yes].

Call costs [Menu 0-6-2]

Allows you to check the cost of your last call, all calls, remaining and reset the cost. To reset the cost, you need to PIN2 code.

Settings [Menu 0-6-3]

(SIM Dependent)

- ▶ **Set tariff:** You can set the currency type and the unit price. Contact your service providers to obtain charging unit prices. To select the currency or unit in this menu, you need the PIN2 code.
- ▶ **Set credit:** This network allows you to limit the cost

of your calls by selected charging units. If you select **Read**, the number of remaining unit is shown. If you select **Change**, you can change your change limit.

- ▶ **Auto display:** This network service allows you to see automatically the cost of your last calls. If set to **On**, you can see the last cost when the call is released.

GPRS information [Menu 0-7]

You can check the amount of data transferred over the network through the GPRS information option. In addition, you can also view how much time you are online.

Call duration [Menu 0-7-1]

You can check the duration of **Last call** and **All calls**. You can also reset the call timers.

Data volume [Menu 0-7-2]

You can check the **Sent**, **Received** or **All** data volumes and **Reset all**.

Settings [Menu #]

Date & Time

[Menu #-1]

You can set functions relating to the date and time.

Set date

[Menu #-1-1]

► Set date

You can enter the current date.

► Date format

You can set the Date format such as DD/MM/YYYY, MM/DD/YYYY, YYYY/MM/DD.
(D: Day / M: Month / Y: Year)

Set time

[Menu #-1-2]

► Set time

You can enter the current time.

► Time format

Your can set the time format between 24-hour and 12-hour.

Languages

[Menu #-2]

You can change the language for the display texts in your phone. This change will also affect the Language Input mode.

Call settings

[Menu #-3]

You can set the menu relevant to a call by pressing [Select] in the Setting menu.

Call divert

[Menu #-3-1]

The Call divert service allows you to divert incoming voice calls, fax calls, and data calls to another number. For details, contact your service provider.

► All voice calls

Diverts voice calls unconditionally.

► If busy

Diverts voice calls when the phone is in use.

► If no reply

Diverts voice calls which you do not answer.

► If out of reach

Diverts voice calls when the phone is switched off or out of coverage.

► All data calls

Diverts to a number with a PC connection unconditionally.

► All fax calls

Diverts to a number with a fax connection unconditionally.

► Cancel all

Cancels all call divert service.

The submenus

Call divert menus have the submenus shown below.

- **Activate**

Activate the corresponding service.

- To voice mail centre**

Forwards to message centre. This function is not shown at All data calls and All fax calls menus.

- To other number**

Inputs the number for diverting.

- To favourite number**

You can check recent 5 diverted numbers.

- **Cancel**

Deactivate the corresponding service.

- **View status**

View the status of the corresponding service.

Answer mode

[Menu #-3-2]

- ▶ **Flip open**

If you select this menu, you can receive an incoming call when only opening flip.

- ▶ **Any key**

If you select this menu, you can receive a call by pressing any key except  [End] key.

- ▶ **SEND key only**

If you select this menu, you can receive a call by only pressing  [Send] key.

Send my number

[Menu #-3-3]

(network and subscription dependent)

- ▶ **On**

You can send your phone number to another party. Your phone number will be shown on the receiver's phone.

- ▶ **Off**

Your phone number will not be shown.

- ▶ **Set by network**

If you select this, you can send your phone number depending on two line service such as line 1 or line 2.

Call waiting

[Menu #-3-4]

(network dependent)

- ▶ **Activate**

If you select Activate, you can accept a waiting (receiving) call.

- ▶ **Cancel**

If you select Cancel, you cannot recognize the waiting (receiving) call.

- ▶ **View status**

Shows the status of Call waiting.

Minute minder

[Menu #-3-5]

If you select **On**, you can check the call duration by beep sound every minute during a call.

Settings [Menu #]

Auto redial

[Menu #-3-6]

► On

When this function is activated, the phone will automatically try to redial in the case of failure to connect a call.

► Off

Your phone will not make any attempts to redial when the original call has not connected.

Security settings

[Menu #-4]

PIN code request

[Menu #-4-1]

In this menu, you can set the phone to ask for the PIN code of your SIM card when the phone is switched on. If this function is activated, you'll be requested to enter the PIN code.

1. Select PIN code request in the security settings menu, and then press  [Select].
2. Set **On/Off**.
3. If you want to change the setting, you need to enter PIN code when you switch on the phone.
4. If you enter wrong PIN code more than 3 times, the phone will lock out. If the PIN is blocked, you will need to key in PUK code.
5. You can enter your PUK code up to 10 times. If you put wrong PUK code more than 10 times, you can not unlock your phone. You will need to contact your service provider.

Handset lock

[Menu #-4-2]

You can use security code to avoid unauthorized use of the phone. Whenever you switch on the phone, the phone will request security code if you set phone lock to **On**. If you set phone lock to **Automatic**, your phone will request security code only when you change your SIM card.

Call barring

[Menu #-4-3]

The Call barring service prevents your phone from making or receiving certain category of calls. This function requires the call barring password. You can view the following submenus.

► All outgoing calls

The barring service for all outgoing calls.

► Outgoing international

The barring service for all outgoing international calls.

► Outgoing international except home country

The barring service for all international outgoing calls except home network.

► All incoming

The barring service for all incoming calls.

► Incoming when abroad

The barring service for all incoming calls when roaming.

► Cancel all barrings

You can cancel all barring services.

► **Change password**

You can change the password for Call Barring Service.

The submenus:

- **Activate**

Allows to request the network to set call restriction on.

- **Cancel**

Set the selected call restriction off.

- **View status**

View the status whether the calls are barred or not.

Fixed dial number [Menu #-4-4]

(SIM dependent)

You can restrict your outgoing calls to selected phone numbers. The numbers are protected by your PIN2 code.

► **Enable**

You can restrict your outgoing calls to selected phone numbers.

► **Disable**

You can cancel fixed dialling function.

► **Number list**

You can view the number list saved as Fixed dial number.

Change codes [Menu #-4-5]

PIN is an abbreviation of Personal Identification Number to prevent use by unauthorized person.

You can change the access codes: **PIN1 code, PIN2 code, Security code.**

1. If you want to change the Security code/PIN1/PIN2 code input your original code, and then press  [OK].
2. Input new Security code/PIN1/PIN2 code and verify them.

Network settings [Menu #-5]

You can select a network which will be registered either automatically or manually. Usually, the network selection is set to **Automatic.**

Network selection [Menu #-5-1]

► **Automatic**

If you select Automatic mode, the phone will automatically search for and select a network for you. Once you have selected “Automatic”, the phone will be set to “Automatic” even if the power is off and on.

► **Manual**

The phone will find the list of available networks and show you them. Then you can select the network which you want to use if this network has a roaming agreement with your home network operator. The phone let you select another network if the phone fails to access the selected network.

Settings [Menu #]

► Preferred

You can set a list of preferred networks and the phone attempts to register with first, before attempting to register to any other networks. This list is set from the phone's predefined list of known networks.

Band selection [Menu #-5-2]

Use this to set the network band between two choices, GSM 900/1800 or GSM1900.

GPRS settings [Menu #-6]

You can set GPRS service depending on various situations.

Switch on [Menu #-6-1]

If you select this menu, the phone is automatically registered to a GPRS network when you switch the phone on. Starting a WAP or PC dial-up application created the connection between phone and network and data transfer is possible. When you end the application, GPRS connection is ended but the registration to the GPRS network remains.

When needed [Menu #-6-2]

If you select this menu, the GPRS connection is established when you connect a WAP service and closed when you end the WAP connection.

Memory status [Menu #-7]

You can check free space and memory usage of each repository, SIM memory. You can go to each repository menu.

Reset settings [Menu #-8]

You can initialize all factory defaults. You need Security code to activate this function.

There are various accessories for your mobile phone. You can select these options according to your personal communication requirements.



Travel Adapter

This charger allows you to charge the battery while away from home or your office.

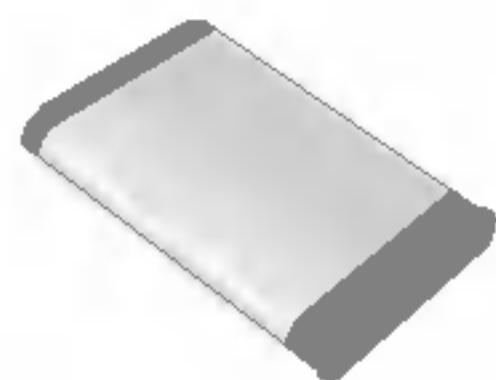

Standard Battery

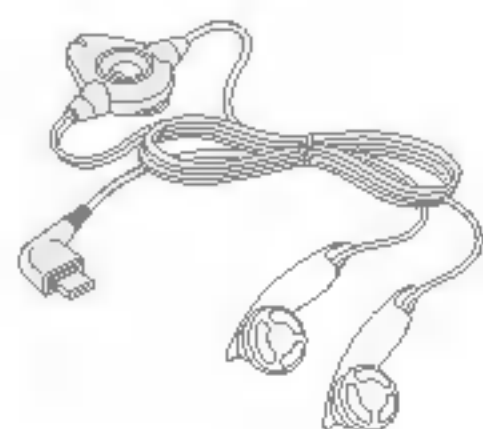

Stereo headset

Allows hands-free operation. Includes earpiece and microphone.

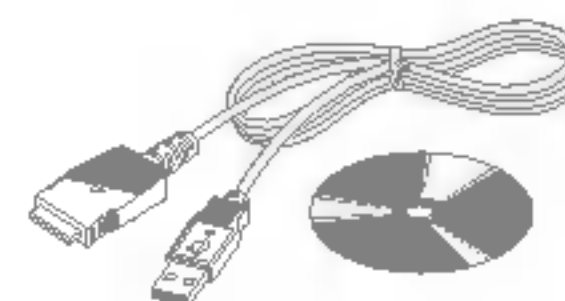

Data cable/CD

You can connect your phone to PC to exchange the data between them.



Memory card adapter/ Memory card

! Note

- Always use genuine LG accessories.
- Failure to do this may invalidate your warranty.
- Accessories may be different in different regions; please check with our regional service company or agent for further enquires.

Technical Data

General

Product name : M4410

System : GSM 900 / DCS 1800 / PCS 1900

Ambient Temperatures

Max. : +55°C

Min : -10°C

Declaration of Conformity LG Electronics

Name

LG Electronics Inc

Address

LG Electronics Inc. LG Twin Towers
20, Yeouido-dong, Yeongdeungpo-gu, Seoul, Korea 150-721

Product Name

E-GSM 900 / DCS 1800 / PCS 1900 Trial Band Terminal Equipment

Model Name

M4410

Trade Name

LG

CE0700

R&TTE Directive 1999/5/EC

EN 301 489-7 : 2002
EN 60950 : 2001
EN 50360 : 2001
3GPP TS 51.010-1,

Selection according to requirements of EN 301 511, v7.0.1

The conformity to above standards is verified by 7Layers and Phoenix with Certificate No.(05-111075) and GSM test report (no.4_LGE_0905_GSM_1), EMC test report(no. HCT-C05-0501), safety test report(no. ITYA0108825M1) and SAR test report(no. TCMA0813254)

I hereby declare under our sole responsibility that the product mentioned above to which this declaration relates complies with the above mentioned standards and Directives

Name

JIn Seog, KIm / Director 10.June.2004

Issued Date



LG Electronics Inc. Amsterdam Office

Veluwezoom 15, 1327 AE Almere, The Netherlands

Tel : +31 - 36- 547 - 8940, e-mail : seokim @ lge.com

Signature of representative