



website <http://www.lgservice.com>
e-mail <http://www.lgservice.com> <http://www.lgservice.com> up.html

LG

LG Ceiling suspended Type Air Conditioner

OWNER'S MANUAL

MODELS: VL, VK, VJ Chassis

Prior to installation, this air-conditioning unit must be submitted for approval by the utility service which provides electricity (EN 61000-2, EN 61000-3 Norm).

IMPORTANT

• Read the manual and thoroughly understand the operating instructions of the air conditioner.
• Refer to the manufacturer's manual for the correct reference after installation.
• ...

P/No.: 3828A20147Q

TABLE OF CONTENTS



FOR YOUR RECORDS

Write the model and serial numbers here:

Model #

Serial #

You can find them on a label on the side of each unit.

Dealer's Name

Date Purchased

- Staple your receipt to this page in the event you need it to prove date of purchase or for warranty issues.



READ THIS MANUAL

Inside you will find many helpful hints on how to use and maintain your air conditioner properly. Just a little preventive care on your part can save you a great deal of time and money over the life of your air conditioner.

You'll find many answers to common problems in the chart of troubleshooting tips. If you review our chart of

Troubleshooting Tips first, you may not need to call for service at all.



PRECAUTION

- Contact the authorized service technician for repair or maintenance of this unit.
- Contact the installer for installation of this unit.
- The air conditioner is not intended for use by young children or invalids without supervision.
- Young children should be supervised to ensure that they do not play with the air conditioner.
- When the power cord is to be replaced, replacement work shall be performed by authorized personnel only using only genuine replacement parts.
- Installation work must be performed in accordance with the National Electric Code by qualified and authorized personnel only.





To prevent injury to the user or other people and property damage, the following instructions must be followed.

■ Incorrect operation due to ignoring instruction will cause harm or damage. The seriousness is classified by the following indications.

⚠ WARNING	This symbol indicates the possibility of death or serious injury.
⚠ CAUTION	This symbol indicates the possibility of injury or damage to properties only.

■ Meanings of symbols used in this manual are as shown below.

	Be sure not to do.
	Be sure to follow the instruction.

⚠ WARNING

■ **Installation**

Do not use a defective or underrated circuit breaker. Use this appliance on a dedicated circuit.

- There is risk of fire or electric shock.

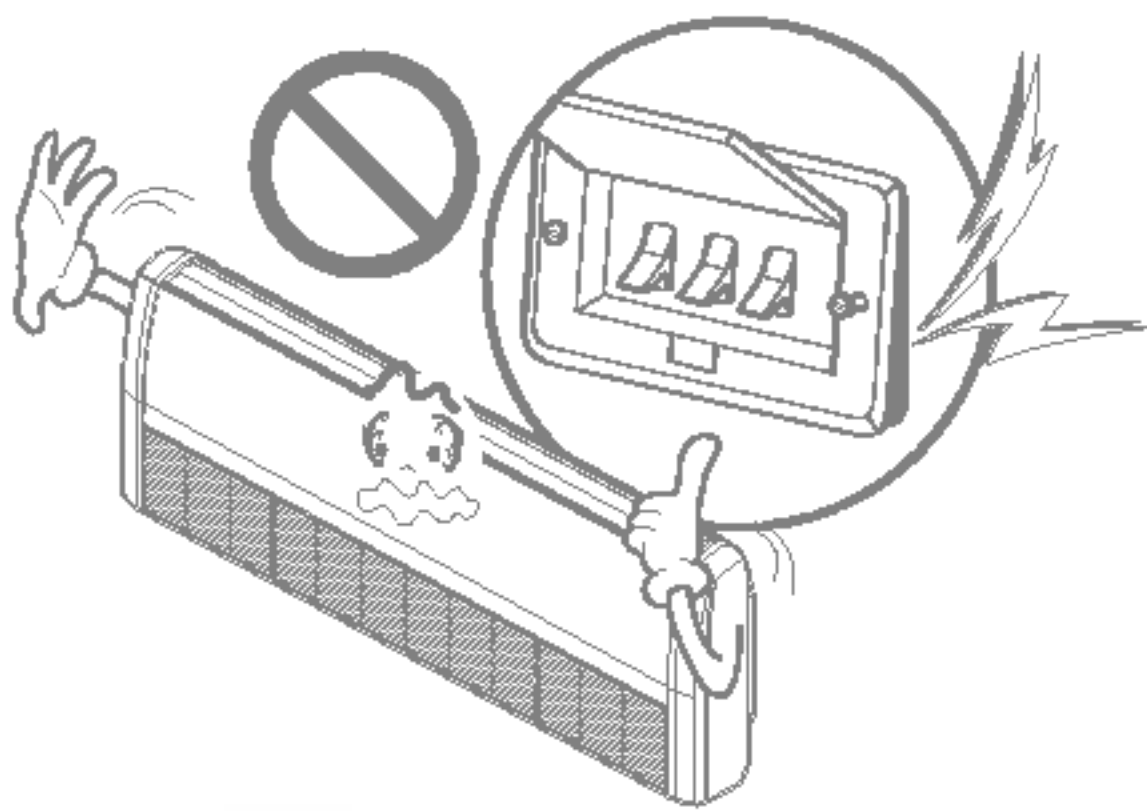

For electrical work, contact the dealer, seller, a qualified electrician, or an Authorized Service Center.

- Do not disassemble or repair the product. There is risk of fire or electric shock.

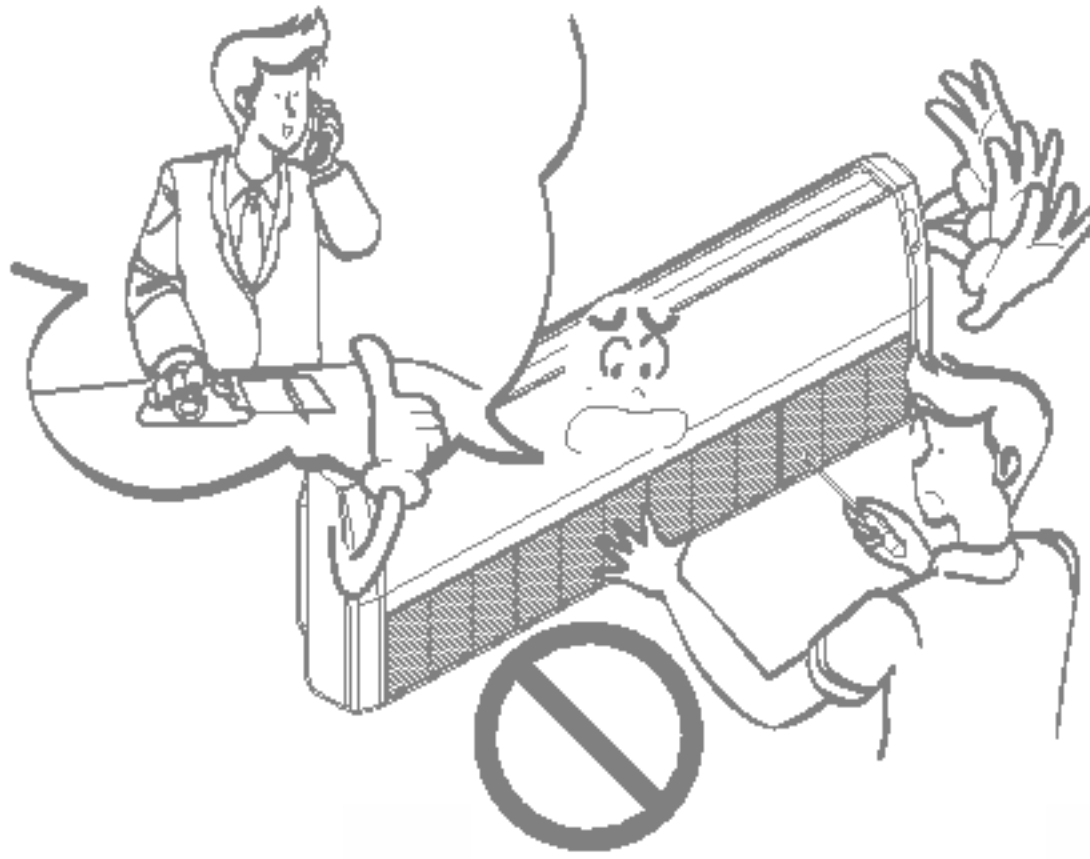

- There is risk of fire or electric shock.

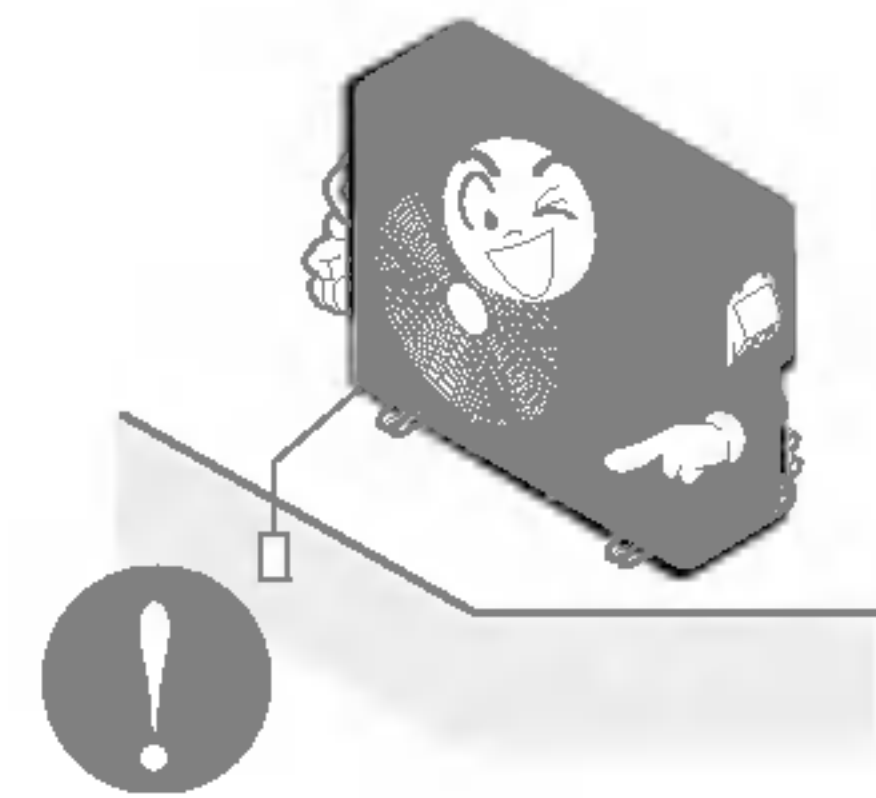

Install the panel and the cover of control box securely.

- There is risk of fire or electric shock.

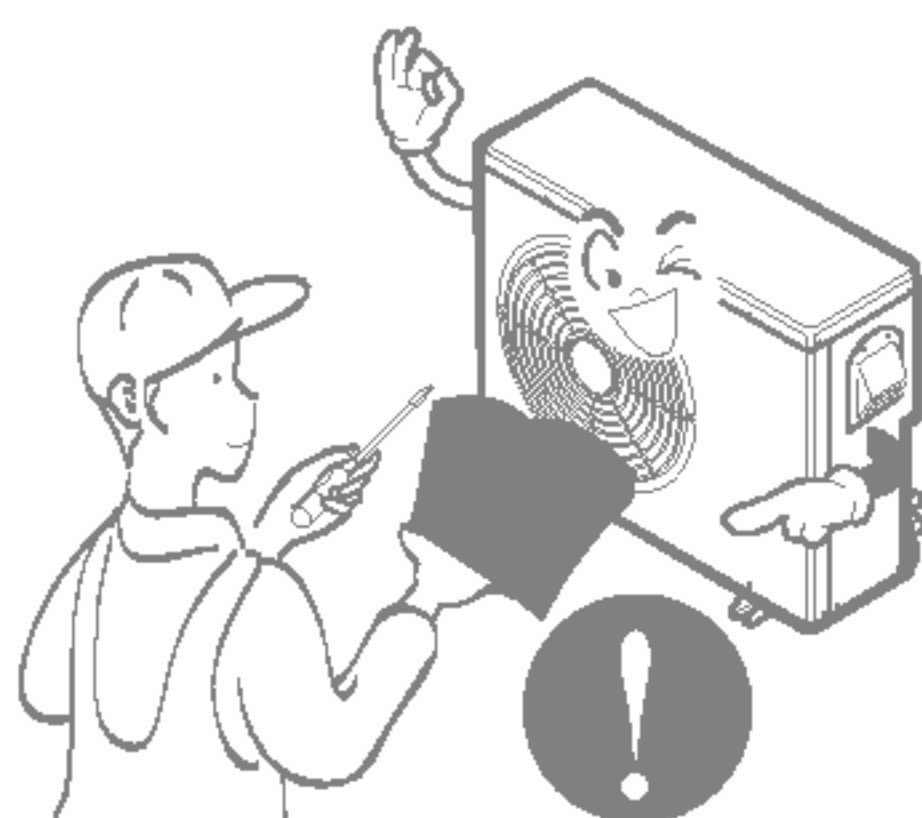

Always install a dedicated circuit and breaker.

- Improper wiring or installation may cause fire or electric shock

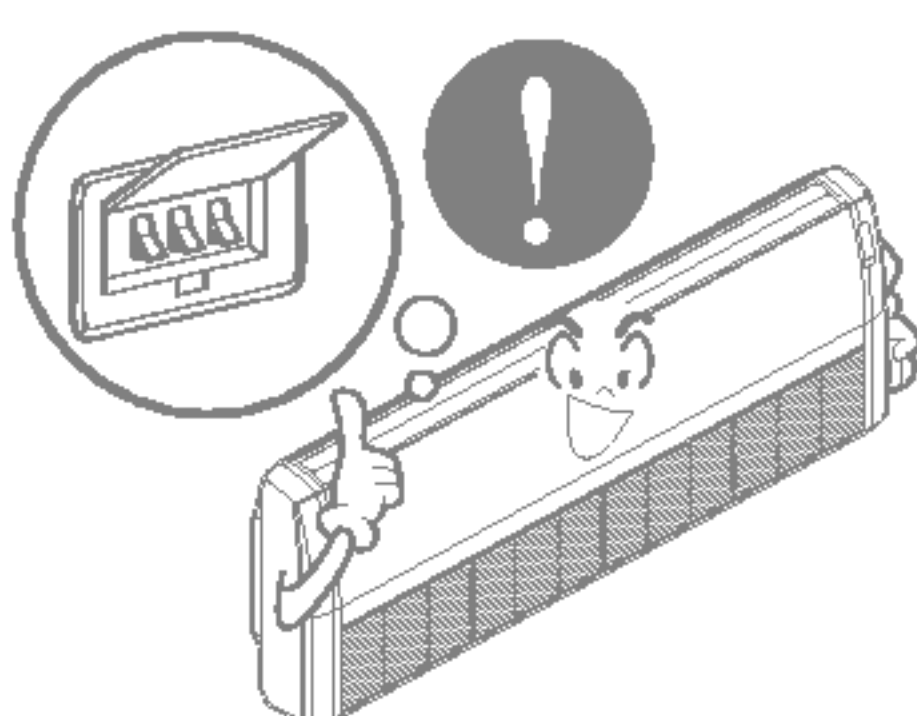

Use the correctly rated breaker or fuse.

- There is risk of fire or electric shock.

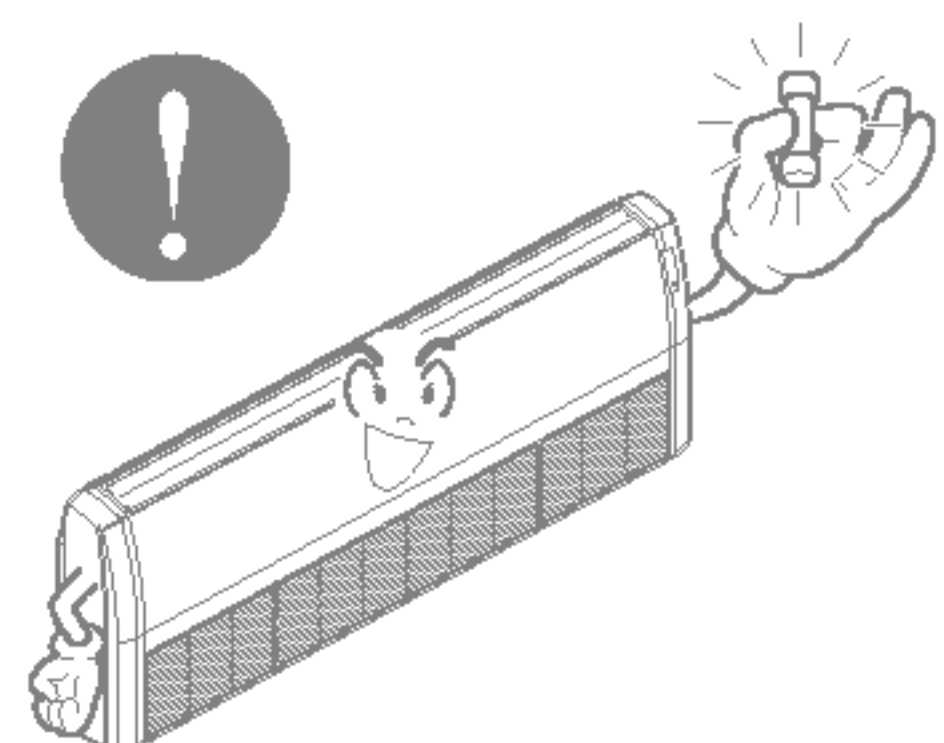

Do not modify or extend the power cable.

- There is risk of fire or electric shock.

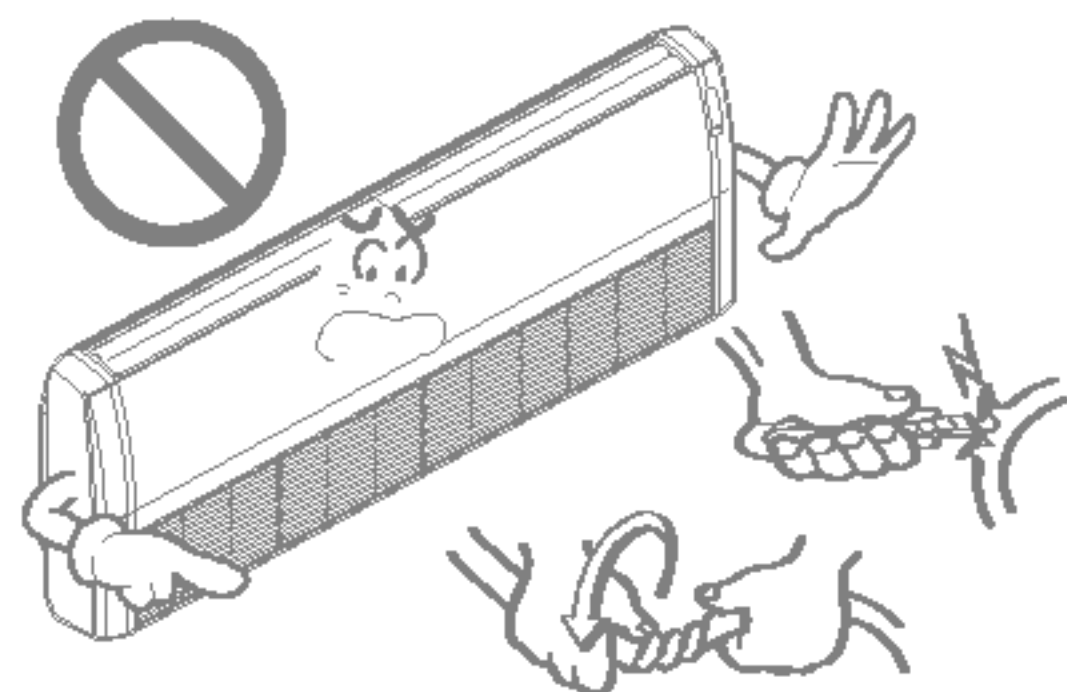

Do not install, remove, or re-install the unit by yourself (customer).

- There is risk of fire, electric shock, explosion, or injury.

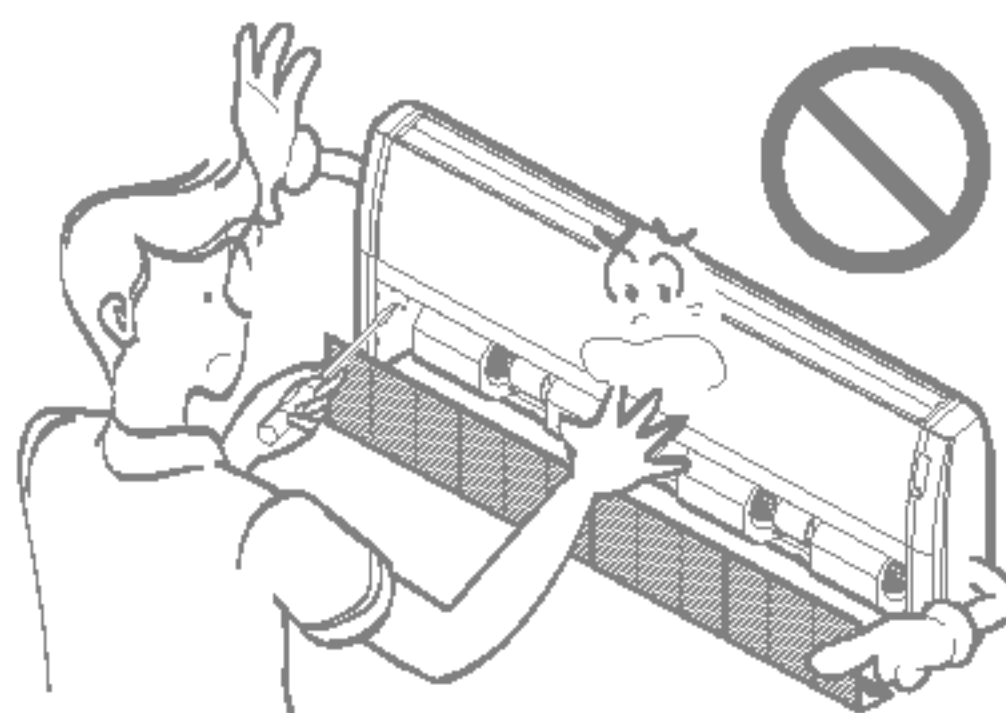

Be cautious when unpacking and installing the product.

- Sharp edges could cause injury. Be especially careful of the case edges and the fins on the condenser and evaporator.

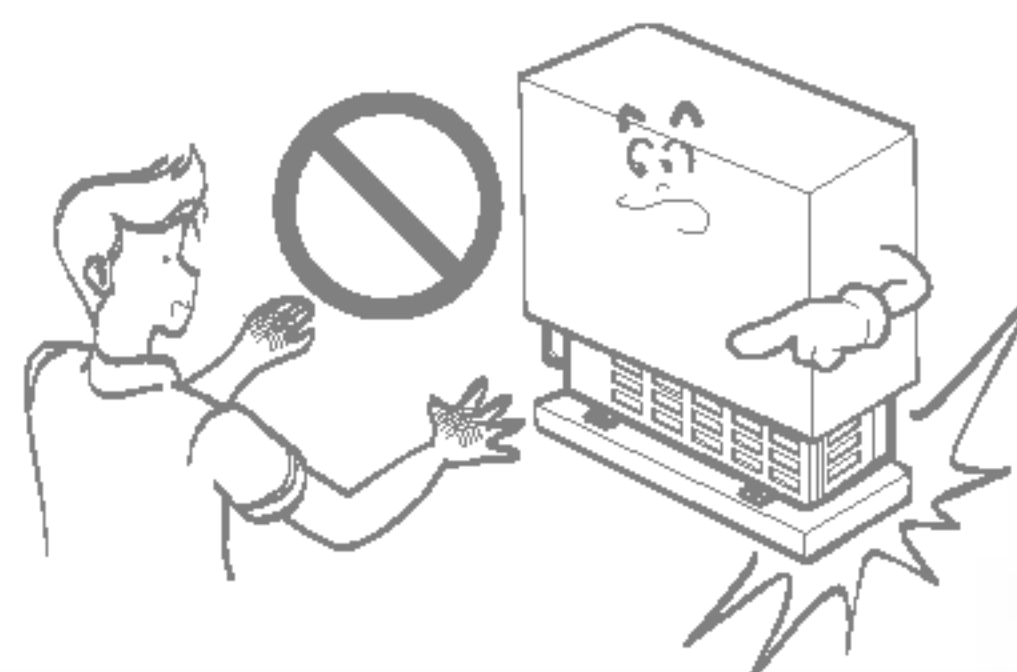

For installation, always contact the dealer or an Authorized Service Center.

- There is risk of fire, electric shock, explosion, or injury.

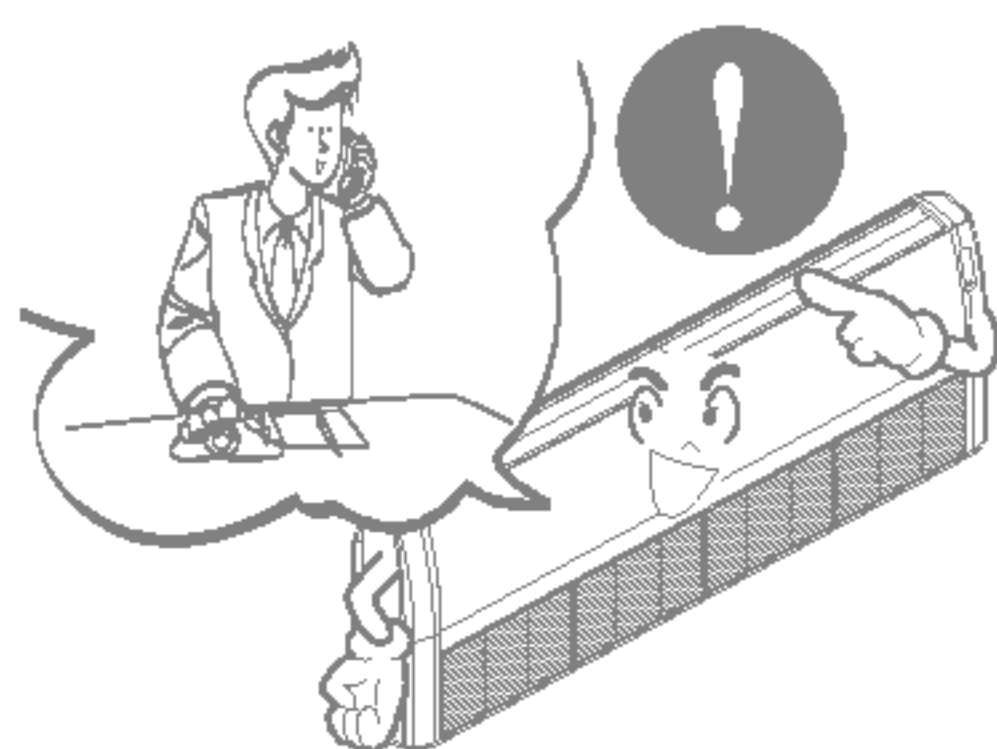

Do not install the product on a defective installation stand.

- It may cause injury, accident, or damage to the product.

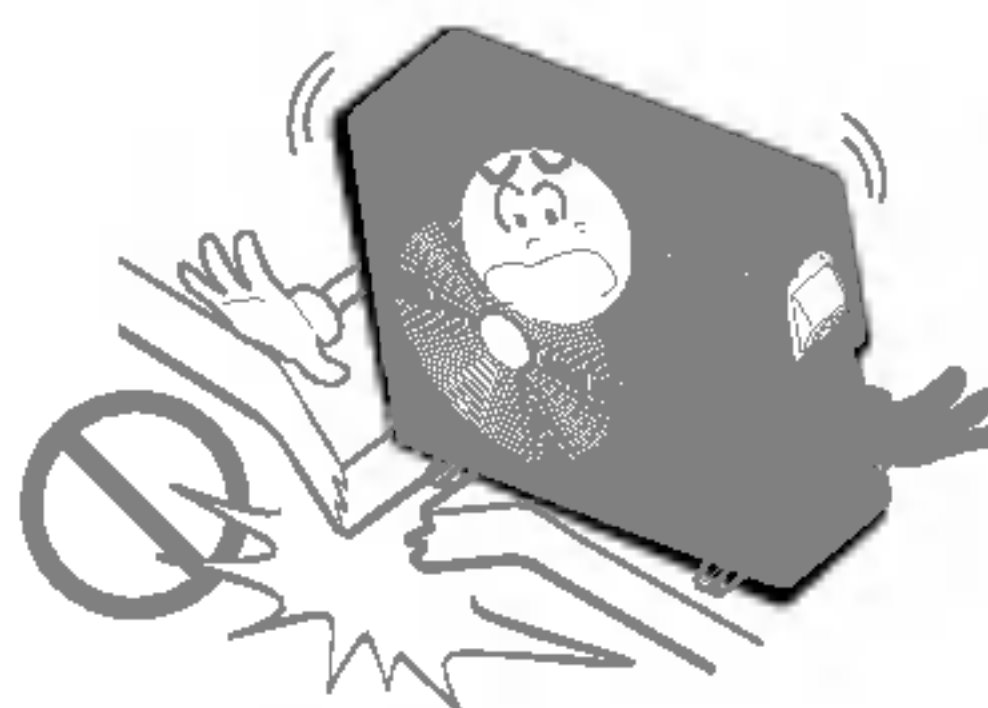

Be sure the installation area does not deteriorate with age.

- If the base collapses, the air conditioner could fall with it, causing property damage, product failure, and personal injury.

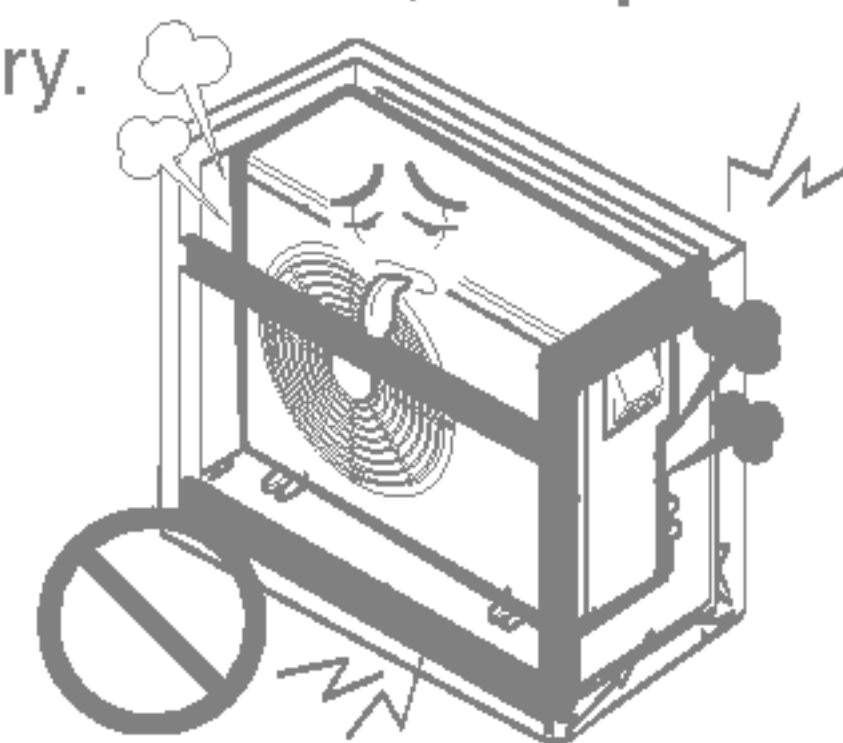

■ Operation

Do not let the air conditioner run for a long time when the humidity is very high and a door or a window is left open.

- Moisture may condense and wet or damage furniture.

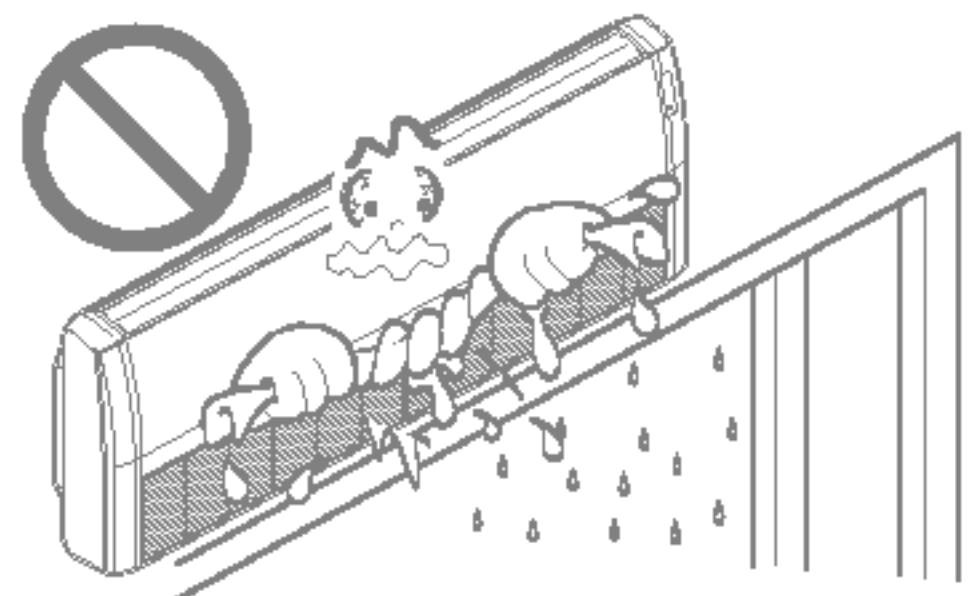

Take care to ensure that power cable could not be pulled out or damaged during operation.

- There is risk of fire or electric shock.

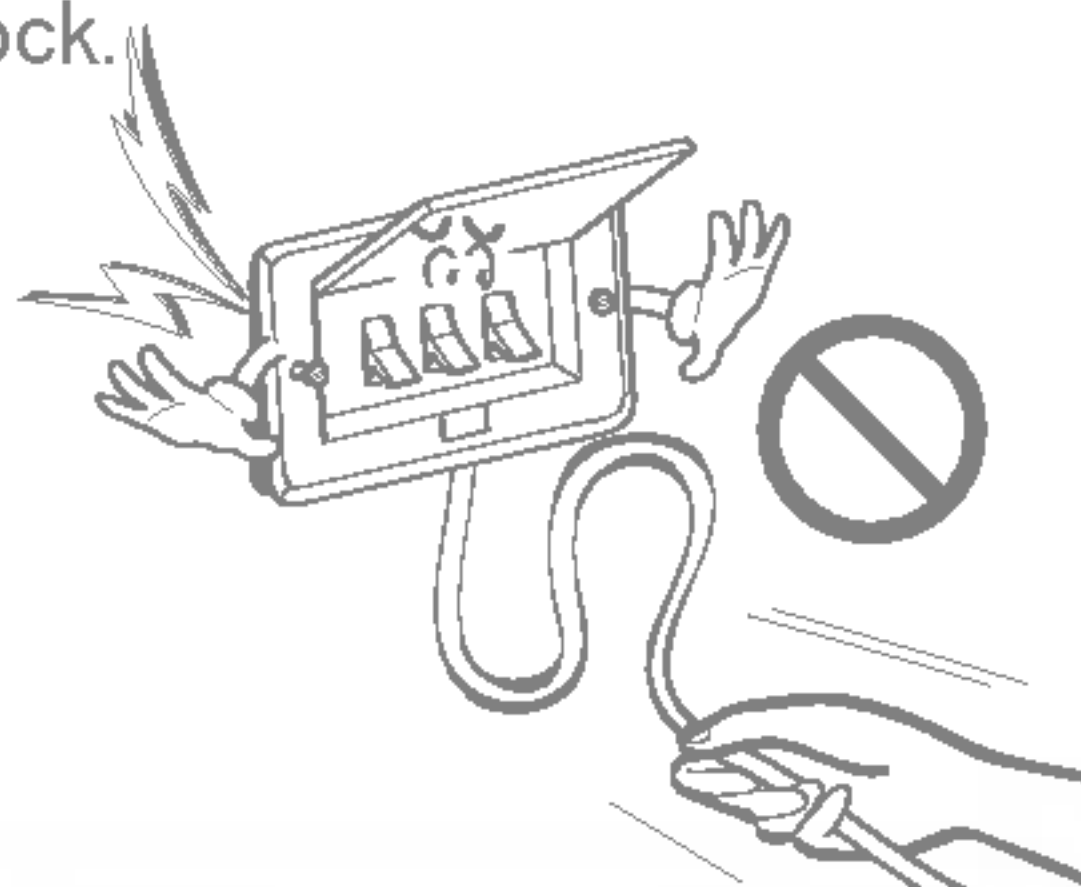

Do not place anything on the power cable.

- There is risk of fire or electric shock.

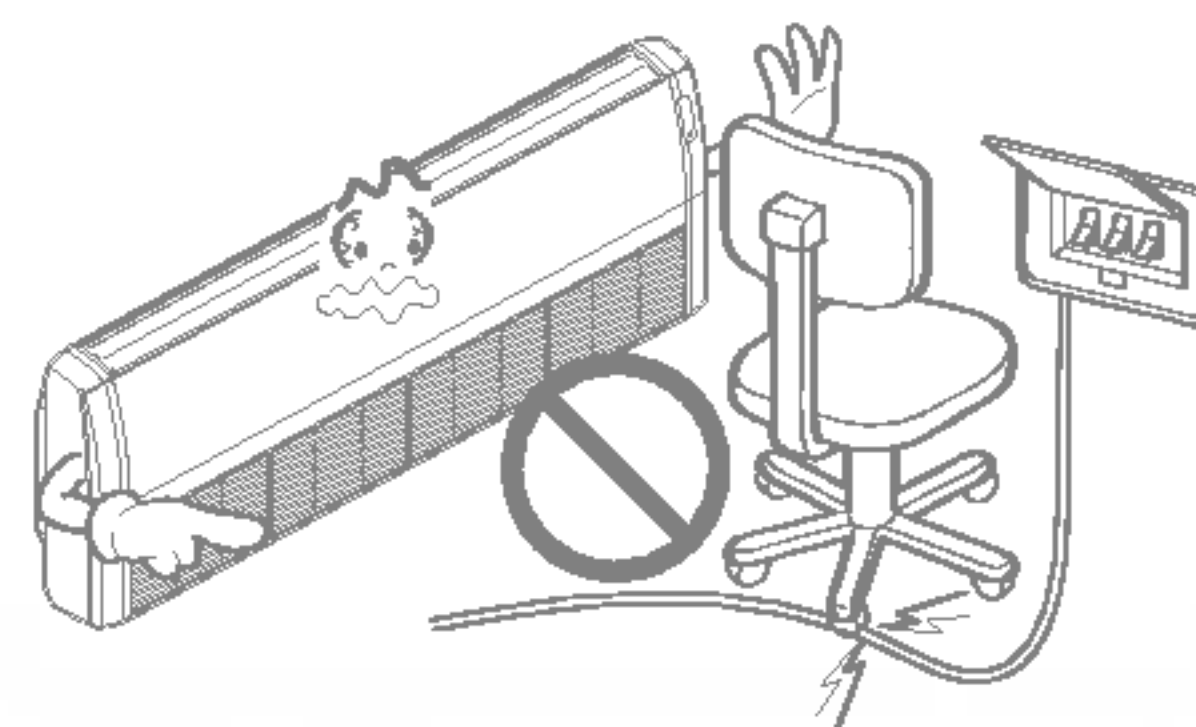

Do not plug or unplug the power supply plug during operation.

- There is risk of fire or electric shock.

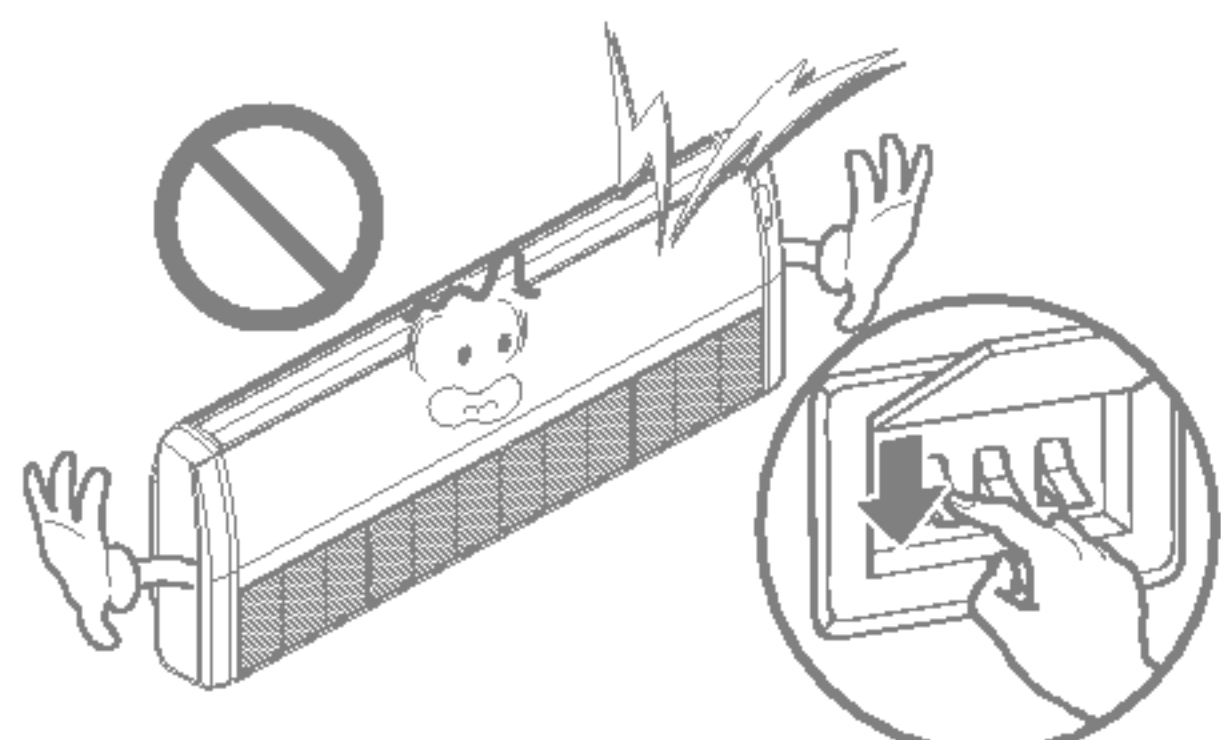

Do not touch(operate) the product with wet hands.

- There is risk of fire or electrical shock.



Do not place a heater or other appliances near the power cable.

- There is risk of fire and electric shock.

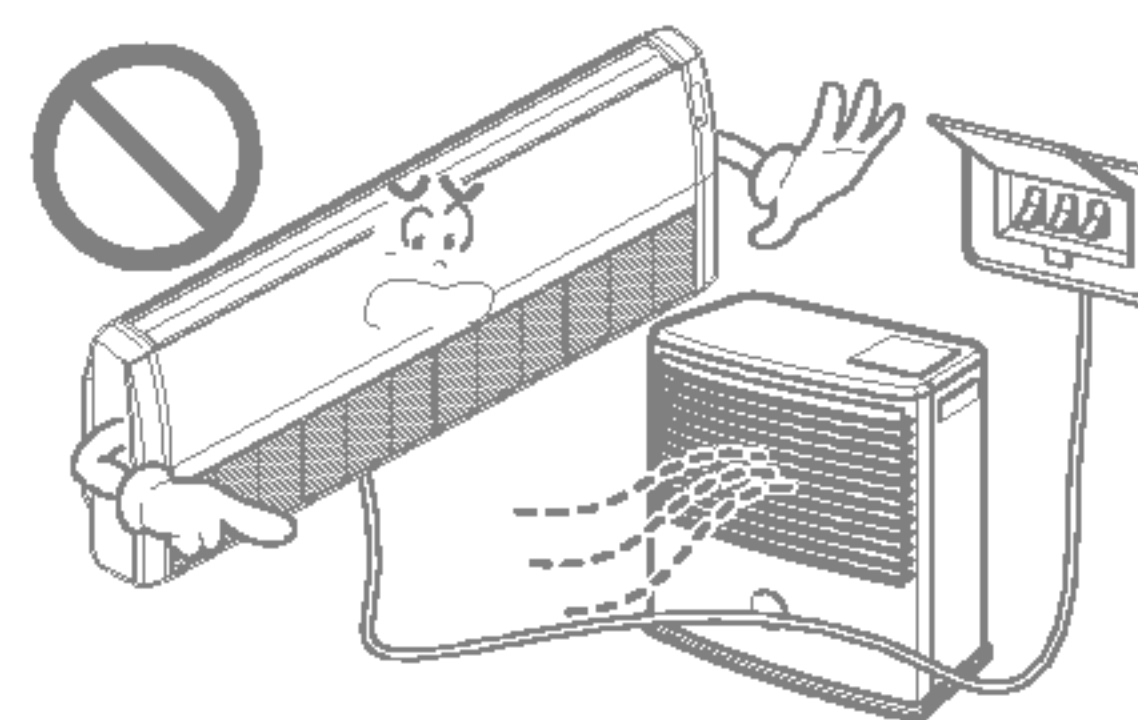

Do not allow water to run into electric parts.

- It may cause There is risk of fire, failure of the product, or electric shock.

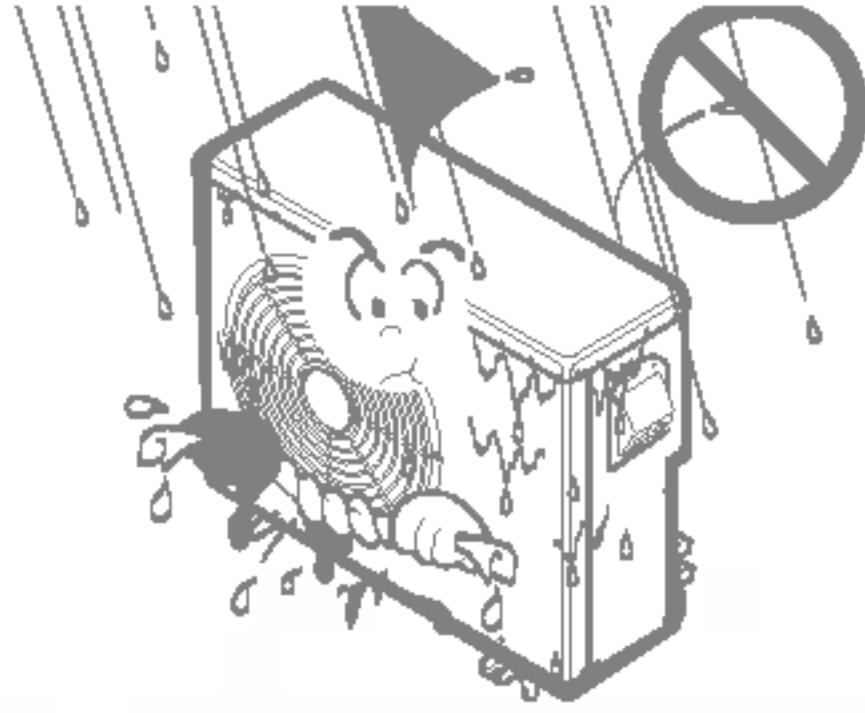

Do not store or use flammable gas or combustibles near the product.

- There is risk of fire or failure of product.

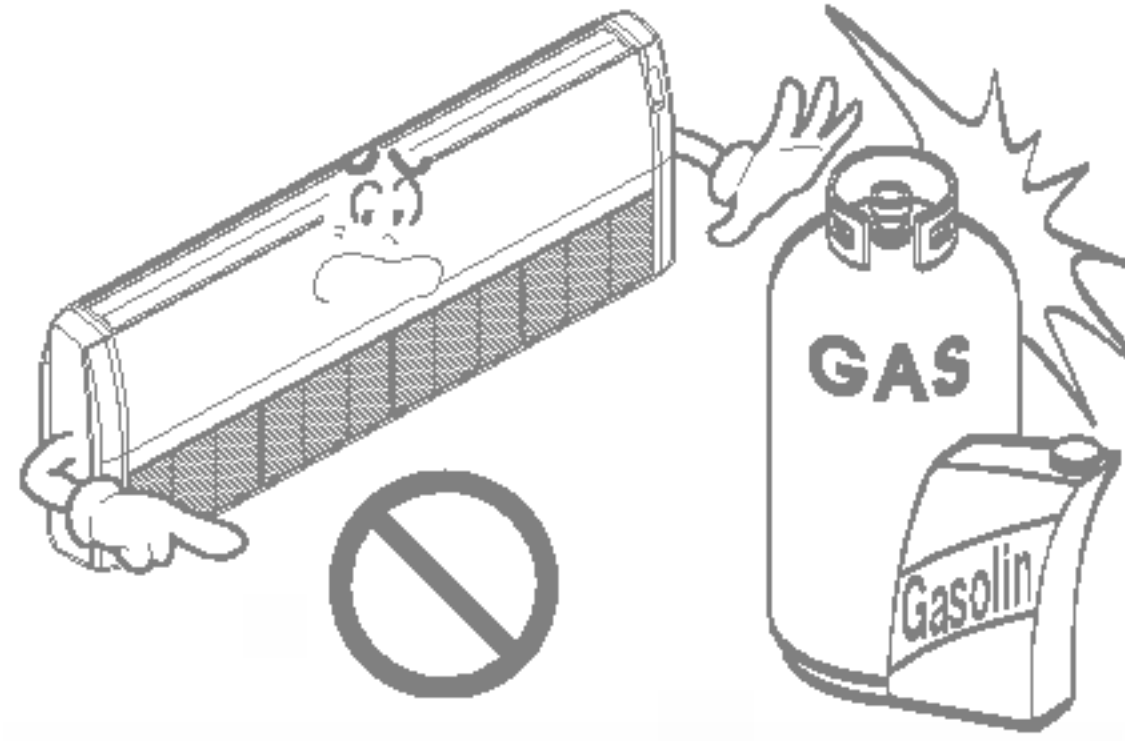

Do not use the product in a tightly closed space for a long time.

- Oxygen deficiency could occur.

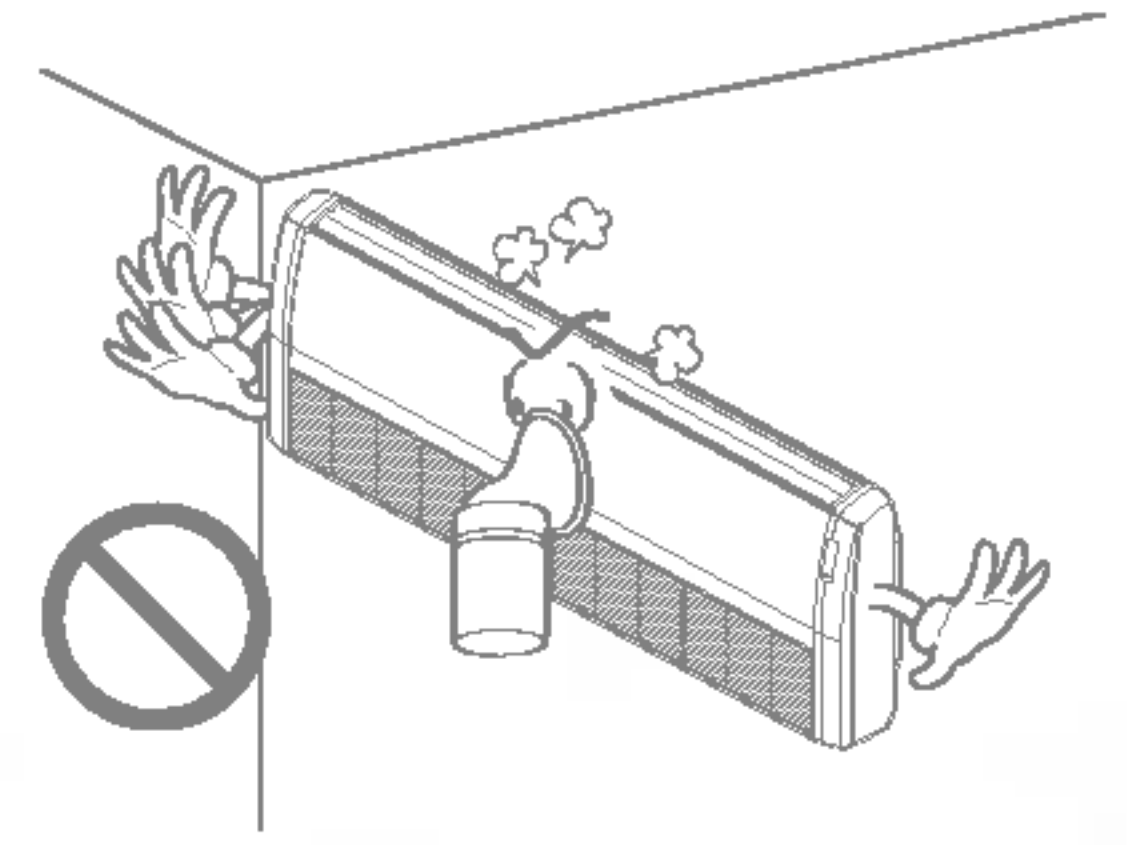

When flammable gas leaks, turn off the gas and open a window for ventilation before turn the product on.

- Do not use the telephone or turn switches on or off. There is risk of explosion or fire

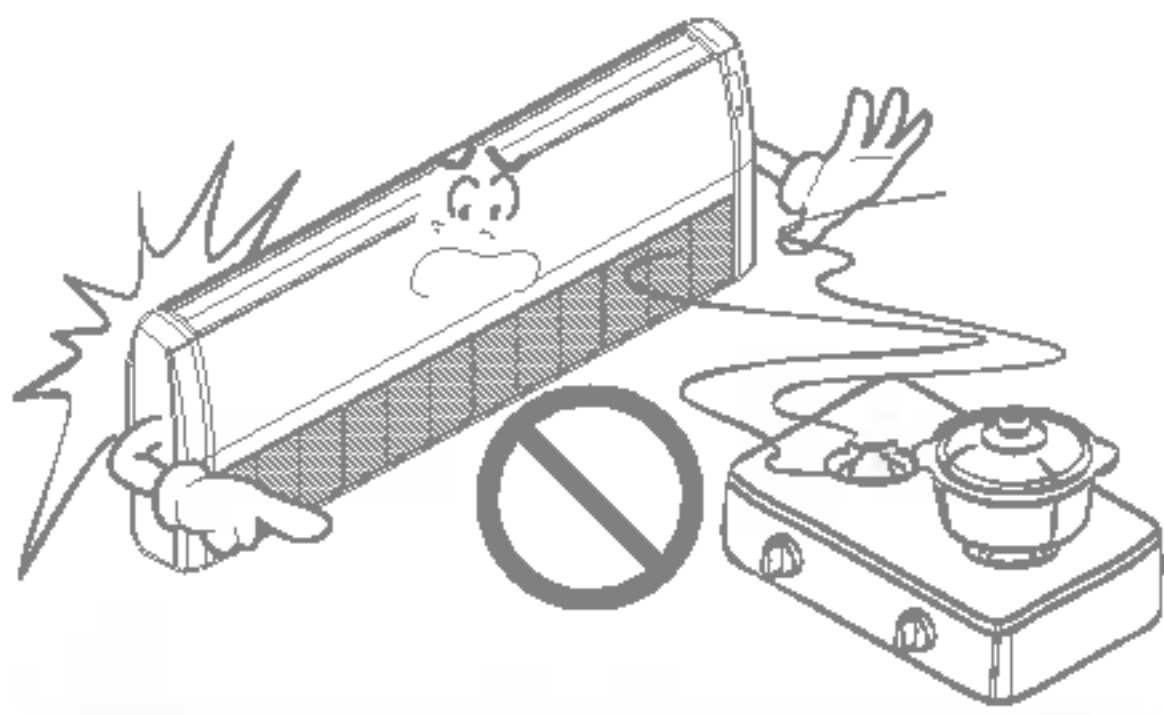

If strange sounds, or small or smoke comes from product. Turn the breaker off or disconnect the power supply cable.

- There is risk of electric shock or fire.

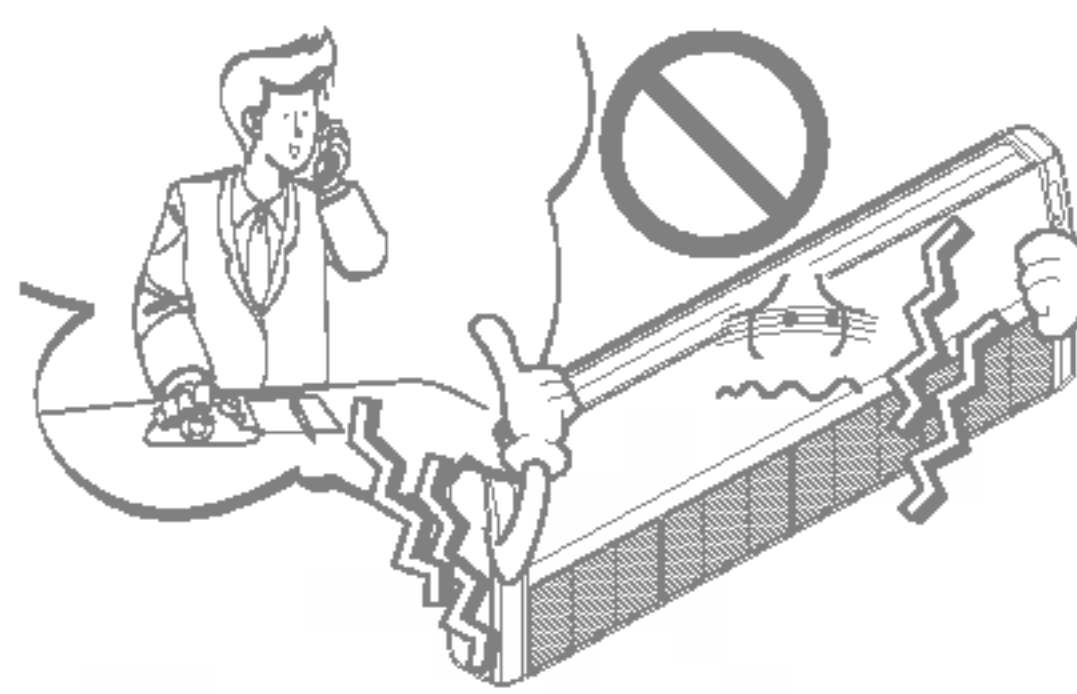

Stop operation and close the window in storm or hurricane. If possible, remove the product from the window before the hurricane arrives.

- There is risk of property damage, failure of product, or electric shock.

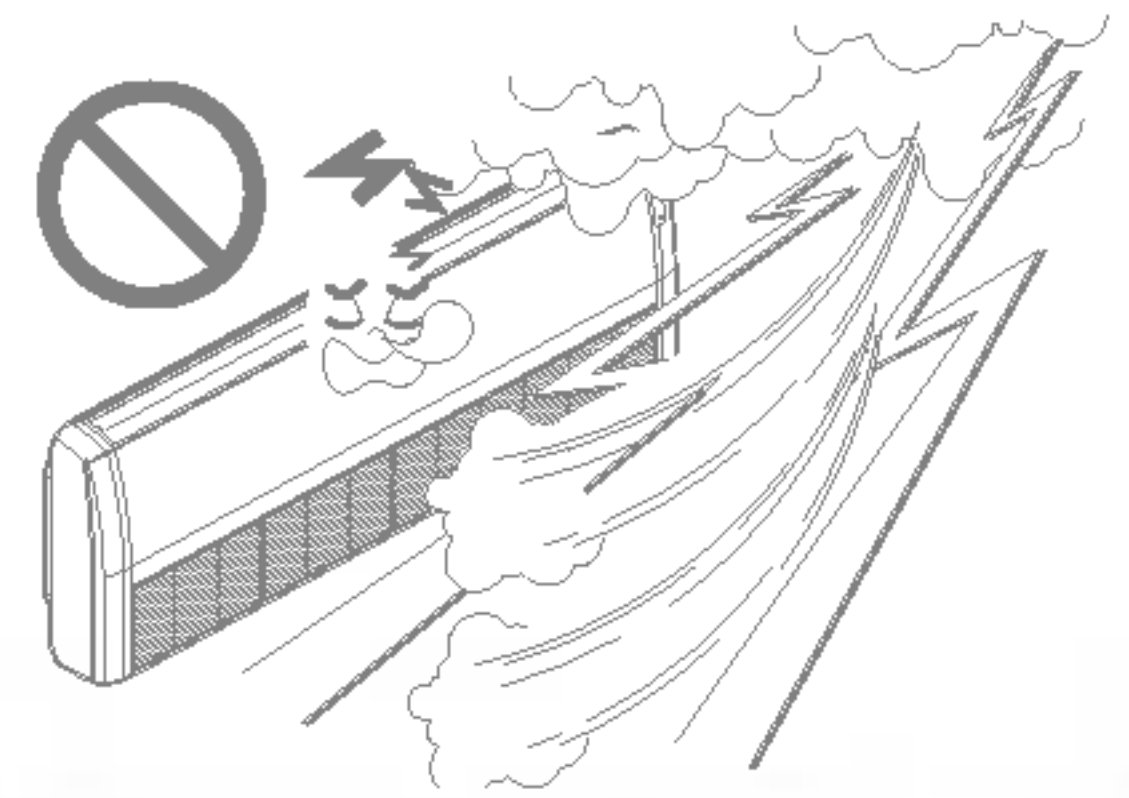

Do not open the inlet grill of the product during operation. (Do not touch the electrostatic filter, if the unit is so equipped.)

- There is risk of physical injury, electric shock, or product failure.

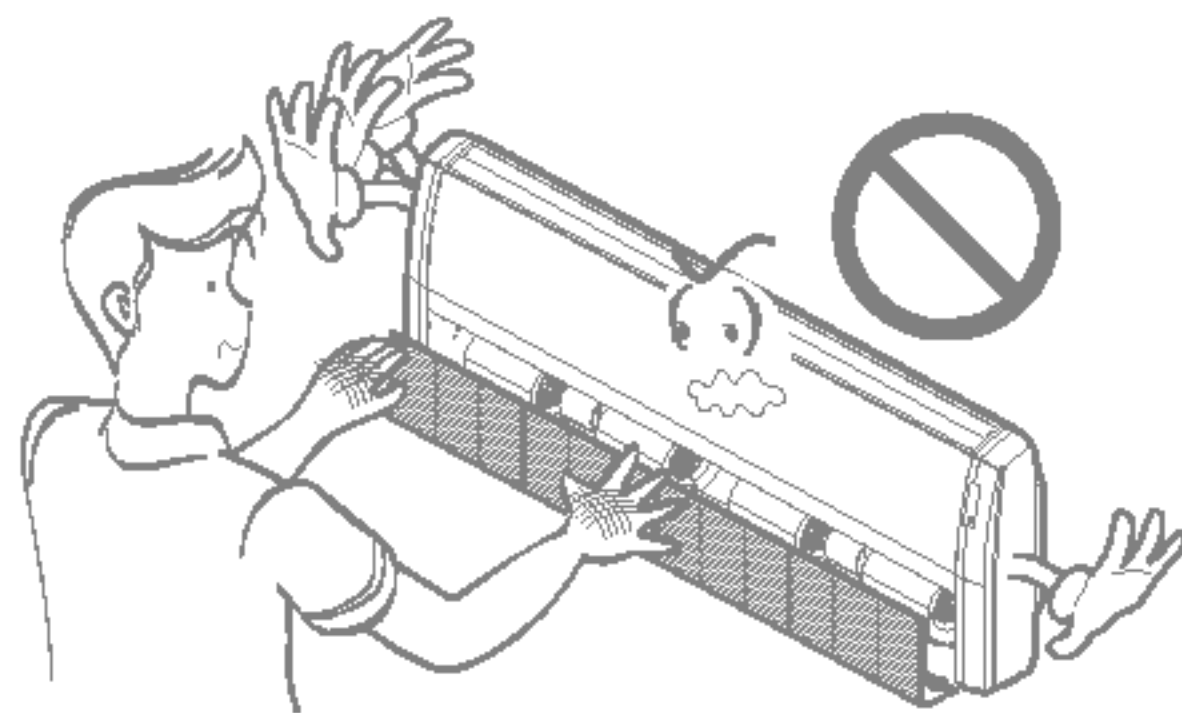

When the product is soaked (flooded or submerged), contact an Authorized Service Center.

- There is risk of fire or electric shock.

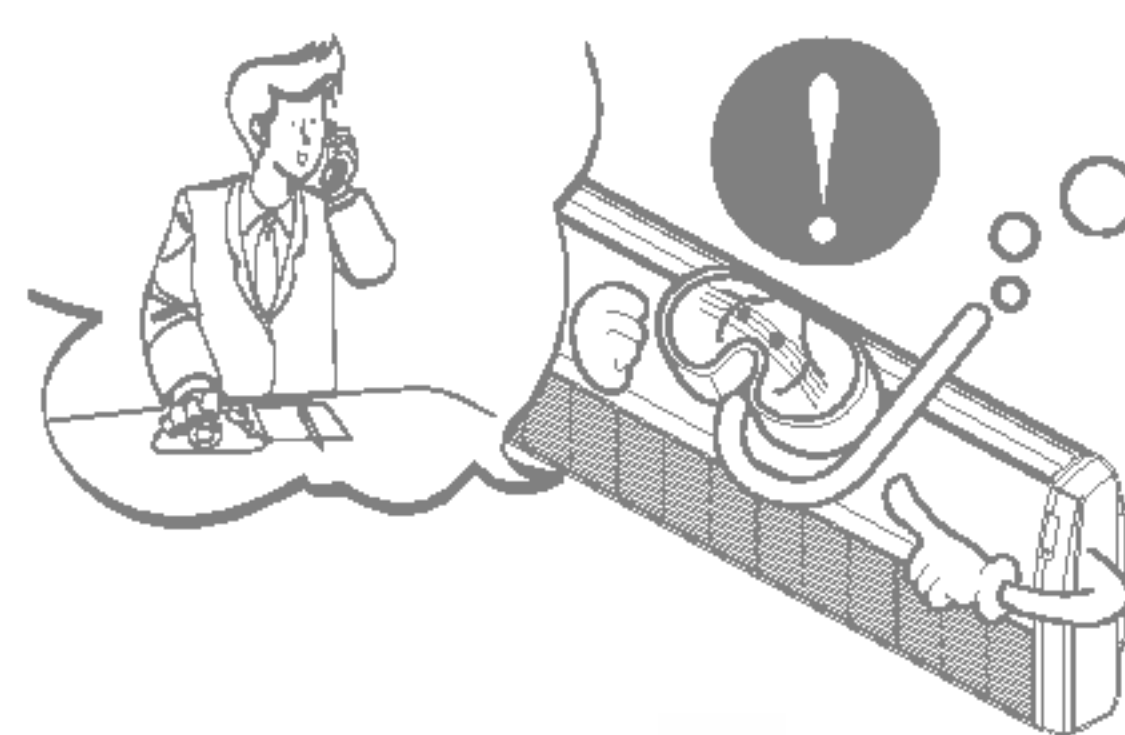

Be cautious that water could not enter the product.

- There is risk of fire, electric shock, or product damage.

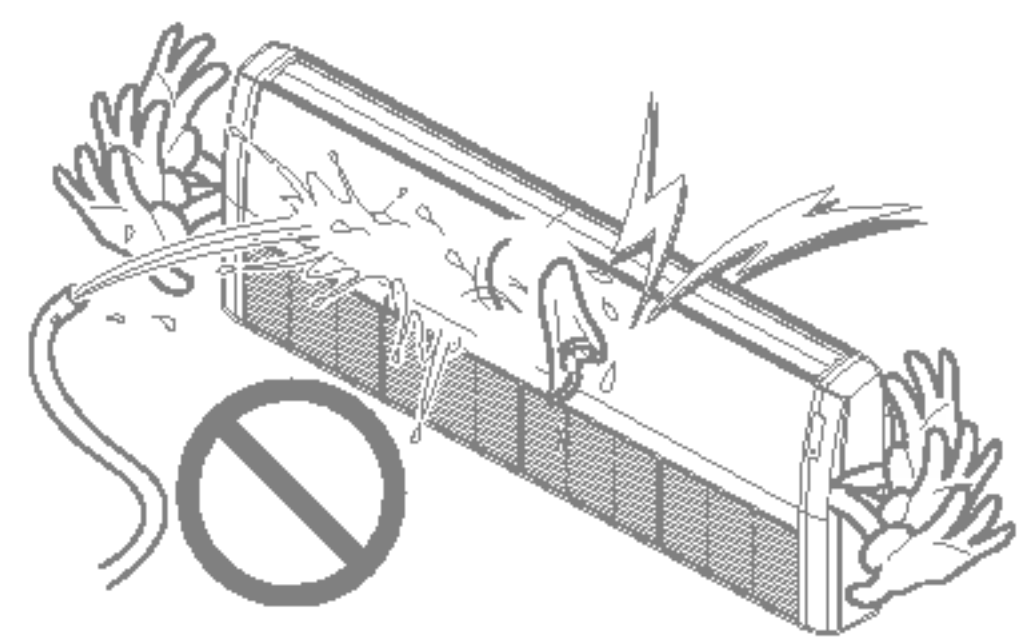

Ventilate the product from time to time when operating it together with a stove, etc.

- There is risk of fire or electric shock.

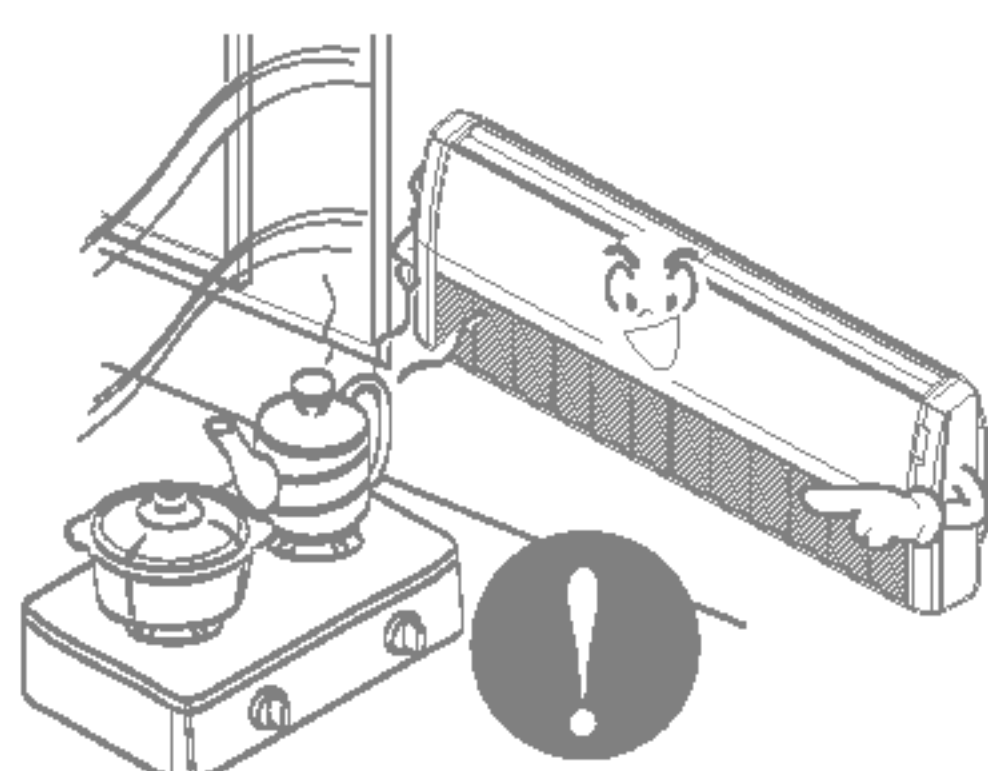

Turn the main power off when cleaning or maintaining the product.

- There is risk of electric shock.

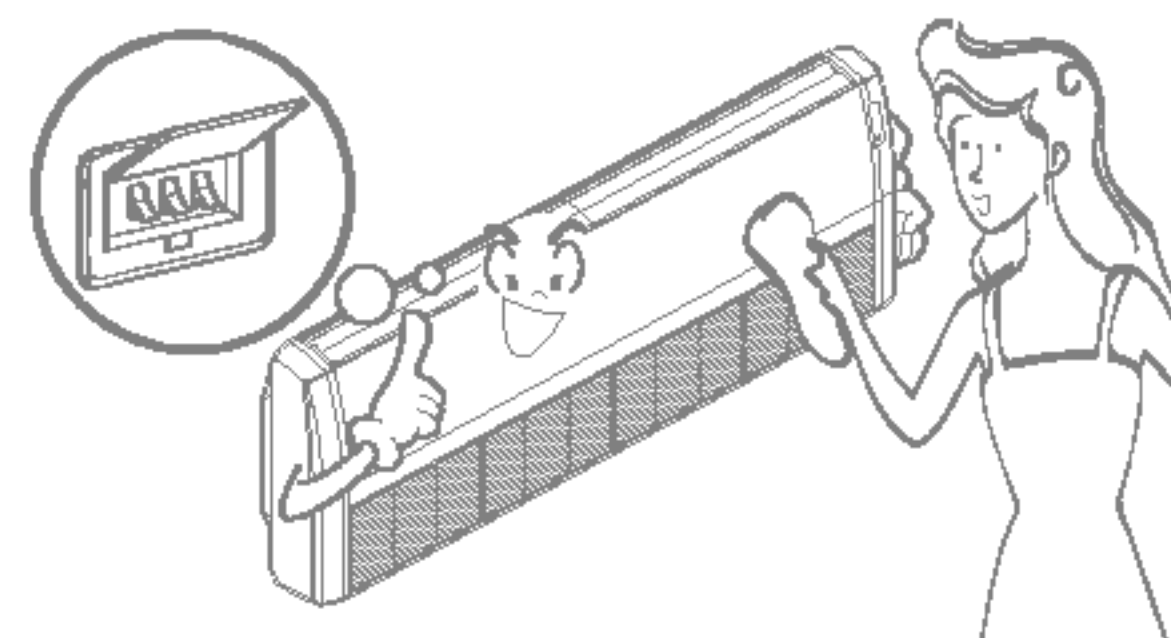

When the product is not be used for a long time, disconnect the power supply plug or turn off the breaker.

- There is risk of product damage or failure, or unintended operation.

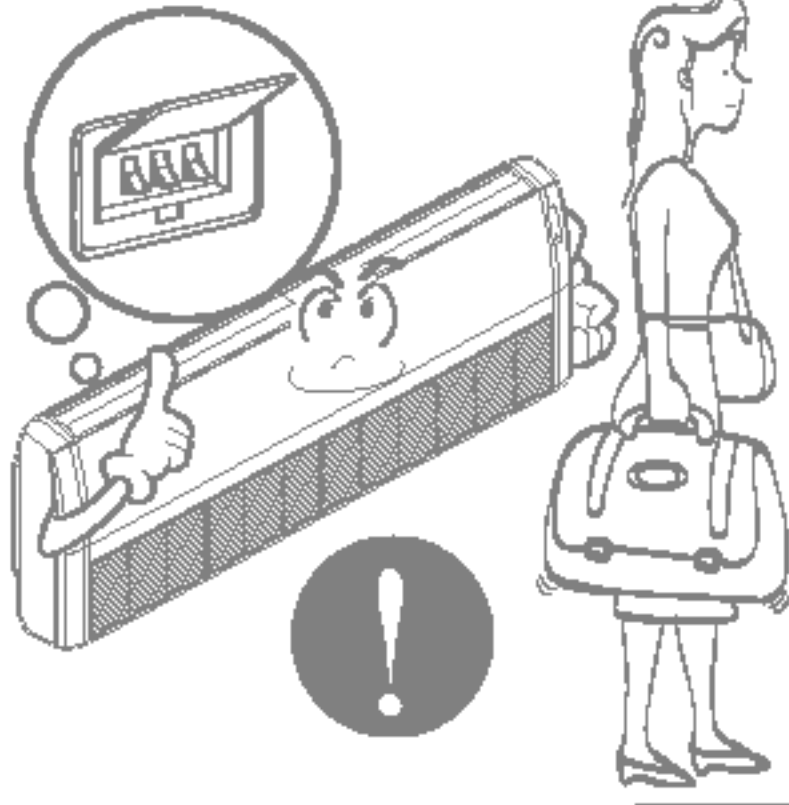

Take care to ensure that nobody could step on or fall onto the outdoor unit.

- This could result in personal injury and product damage.

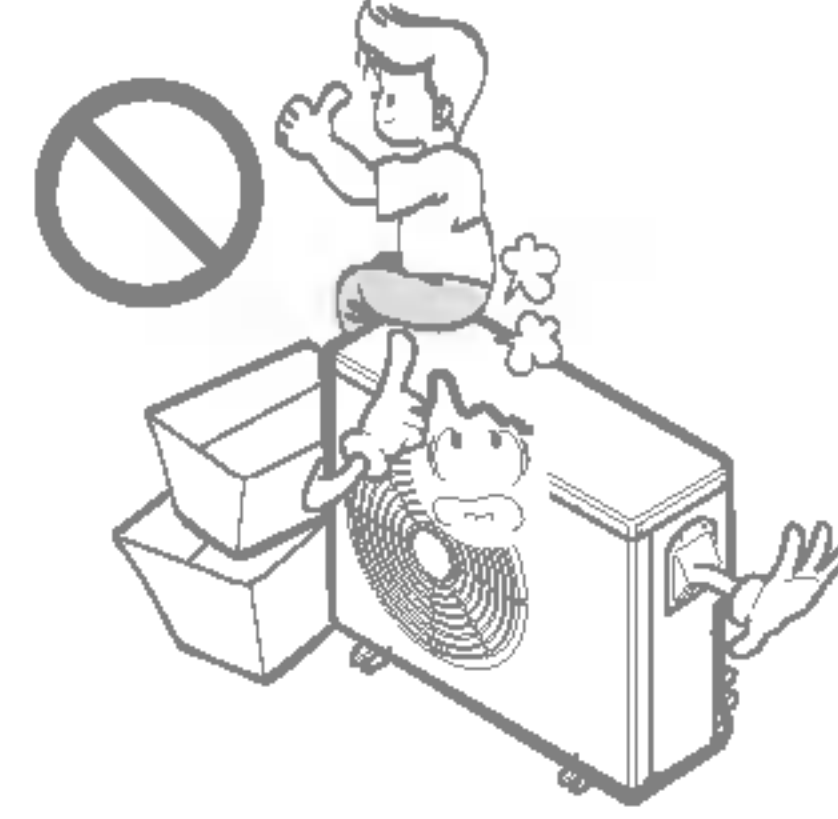

! CAUTION

Installation

Always check for gas (refrigerant) leakage after installation or repair of product.

- Low refrigerant levels may cause failure of product.

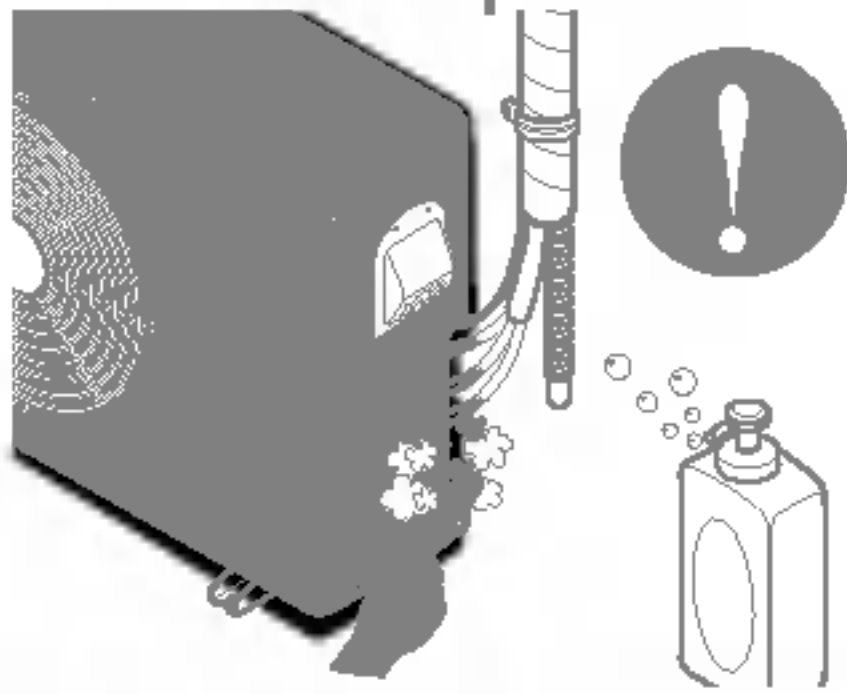

Install the drain hose to ensure that water is drained away properly.

- A bad connection may cause water leakage.

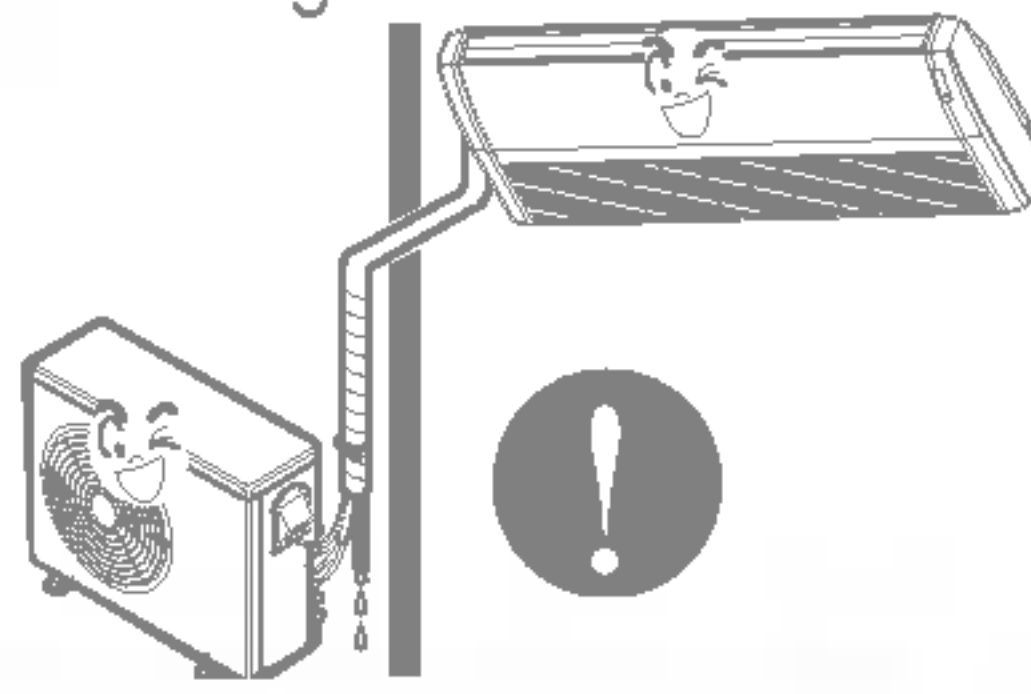

Keep level even when installing the product.

- To avoid vibration or water leakage.

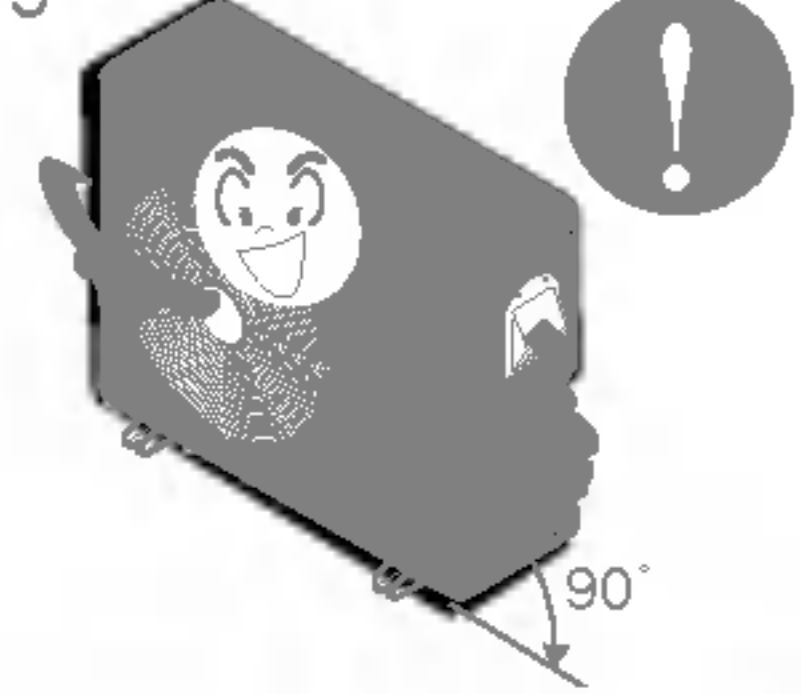

Do not install the product where the noise or hot air from the outdoor unit could damage the neighborhoods.

- It may cause a problem for your neighbors.

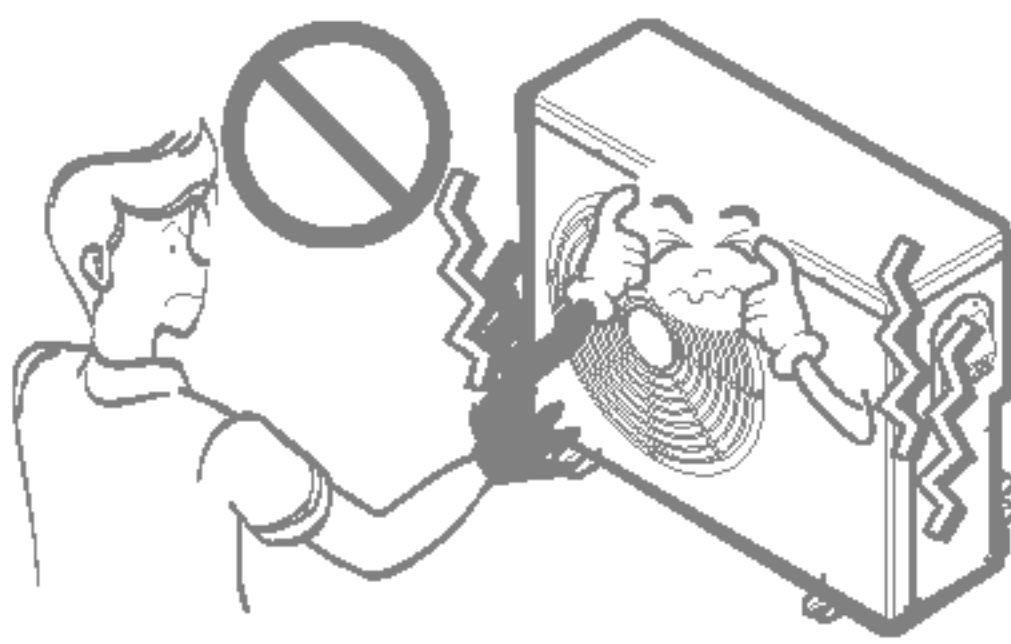

Use two or more people to lift and transport the product.

- Avoid personal injury.

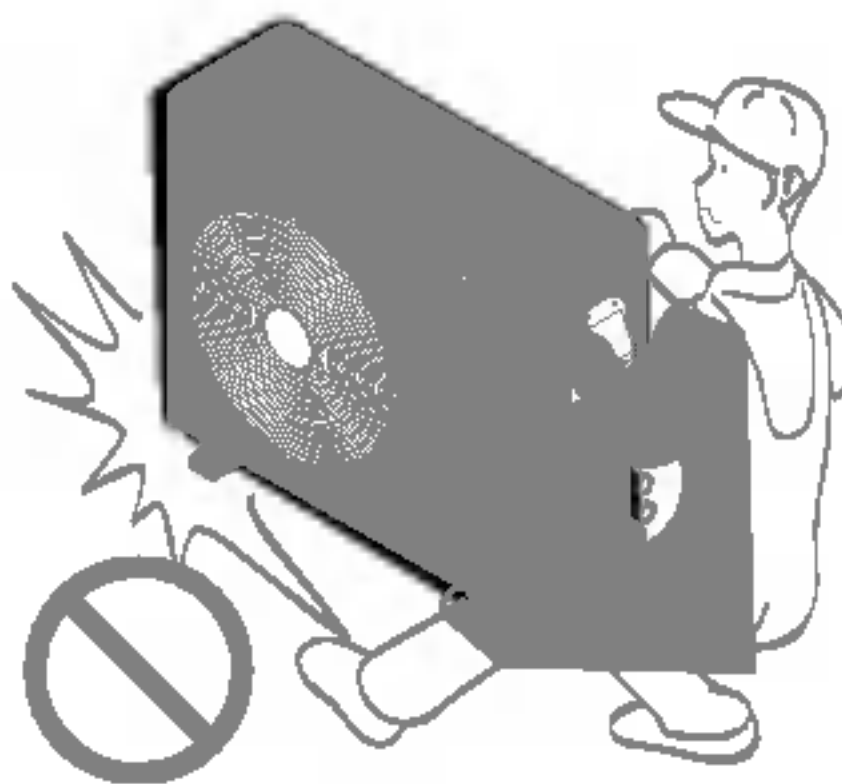

Do not install the product where it will be exposed to sea wind (salt spray) directly.

- It may cause corrosion on the product. Corrosion, particularly on the condenser and evaporator fins, could cause product malfunction or inefficient operation.

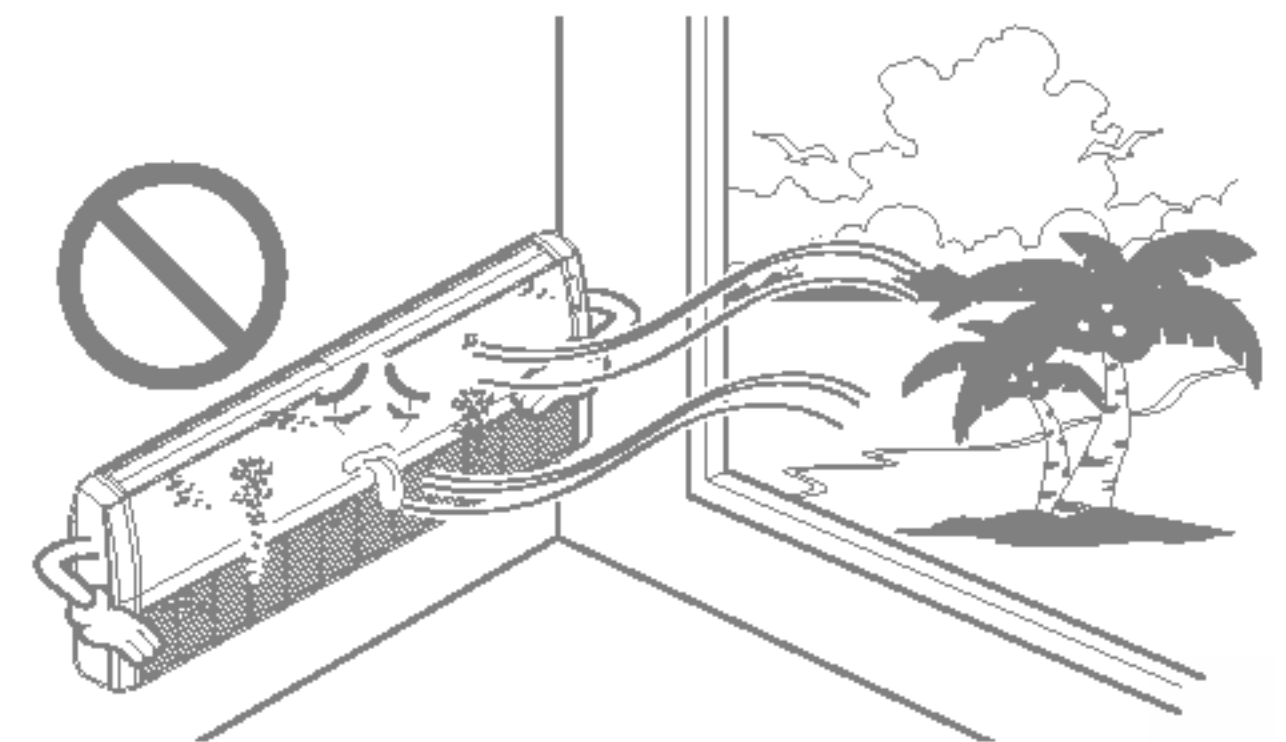

Operation

Do not expose the skin directly to cool air for long periods of time. (Don't sit in the draft.)

- This could harm to your health.

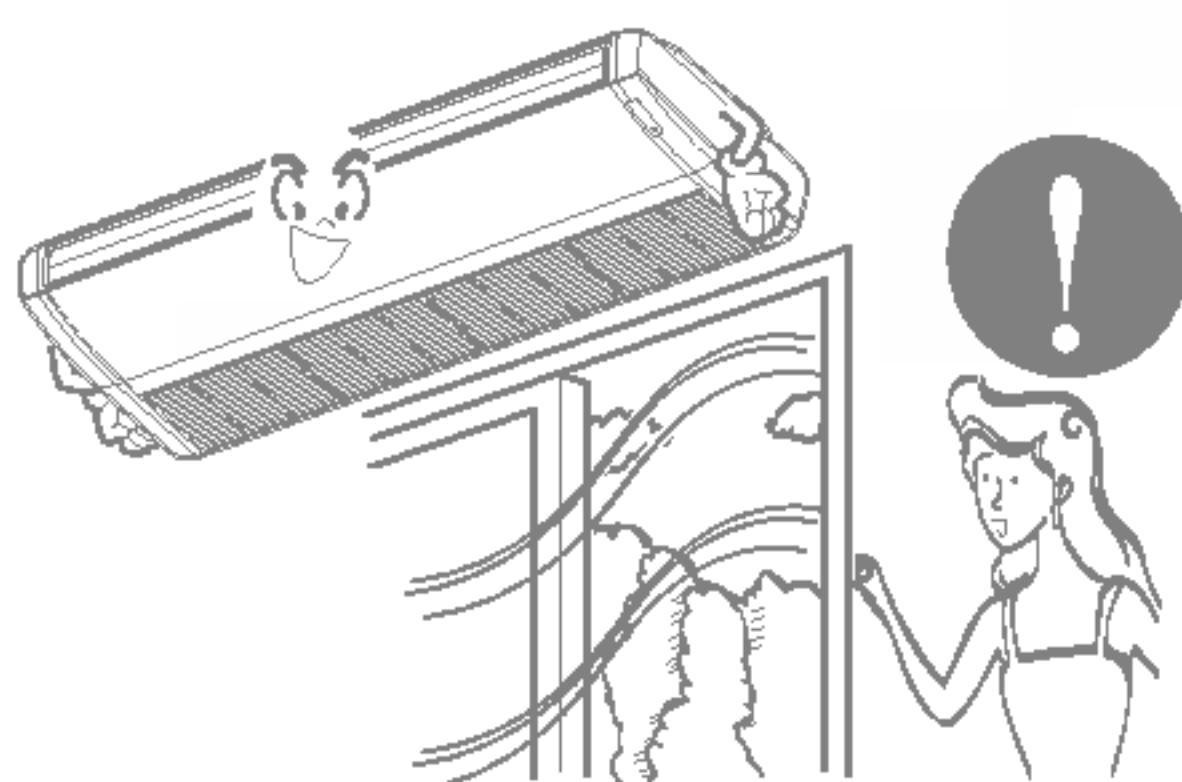

Do not use the product for special purposes, such as preserving foods, works of art, etc. It is a consumer air conditioner, not a precision refrigeration system.

- There is risk of damage or loss of property.

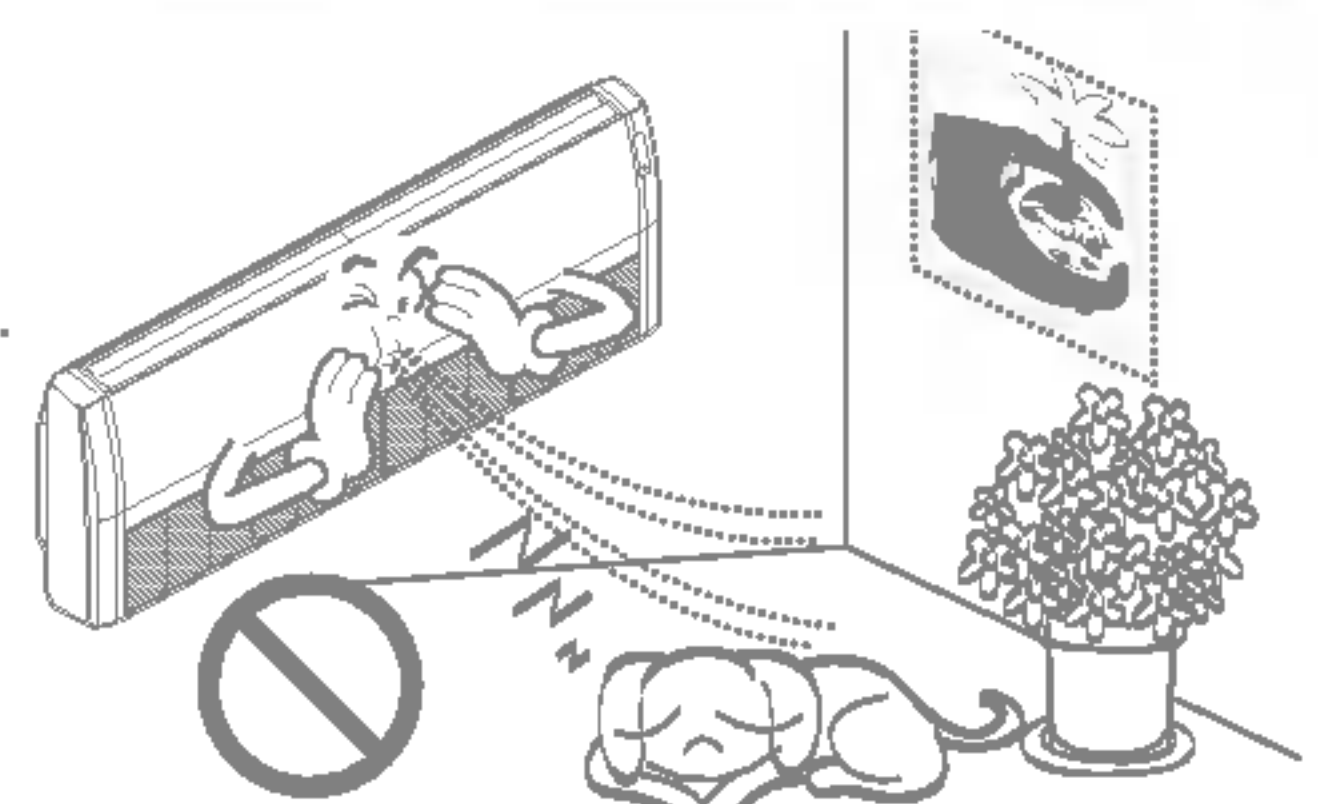

Do not block the inlet or outlet of air flow.

- It may cause product failure.

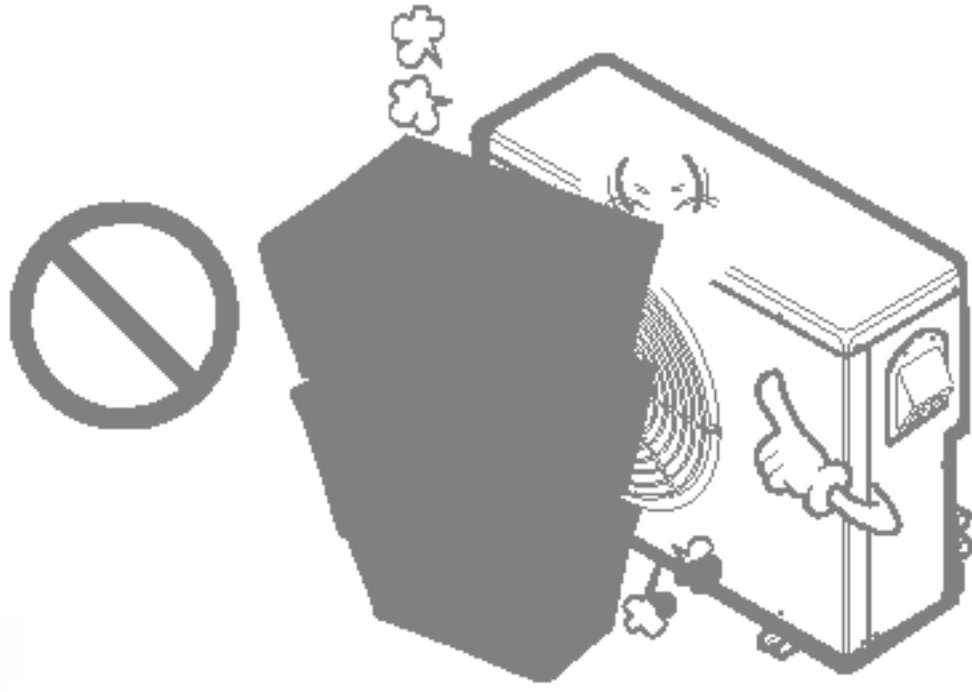

Use a soft cloth to clean. Do not use harsh detergents, solvents, etc.

- There is risk of fire, electric shock, or damage to the plastic parts of the product.

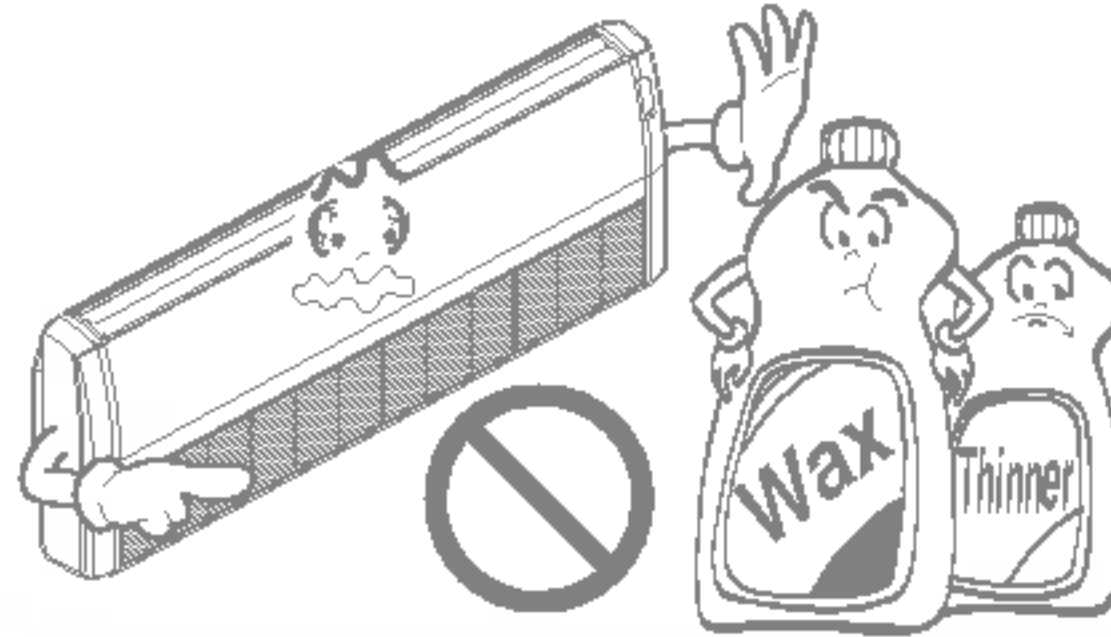

Do not touch the metal parts of the product when removing the air filter. They are very sharp!

- There is risk of personal injury.

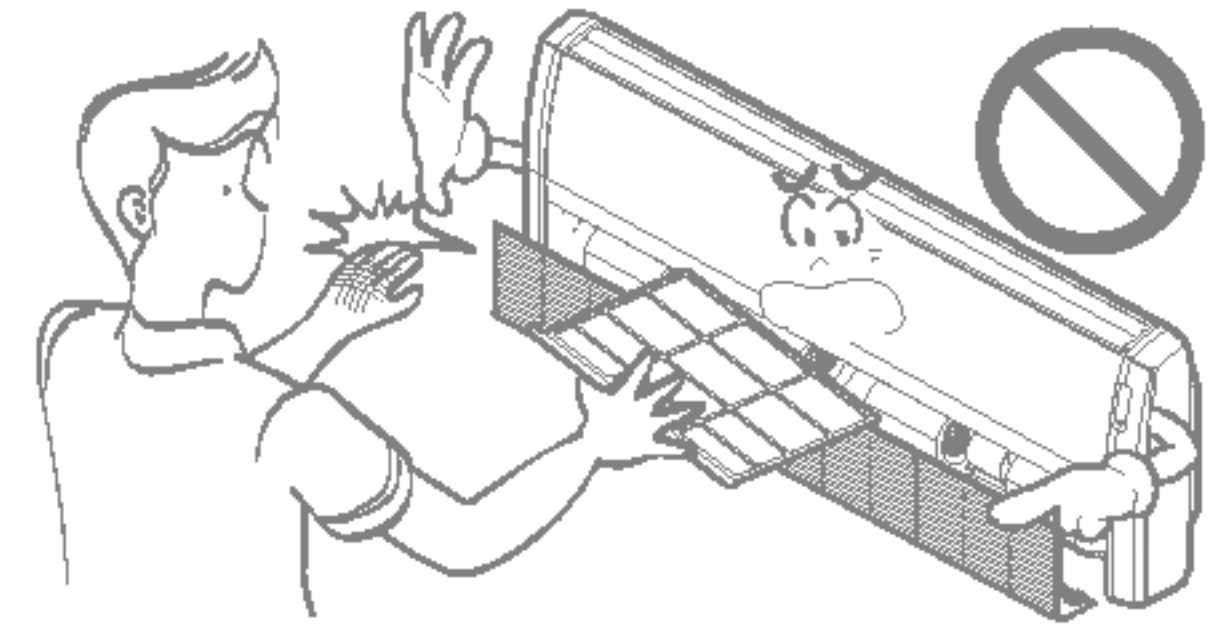

Do not step on or put anything on the product. (outdoor units)

- There is risk of personal injury and failure of product.

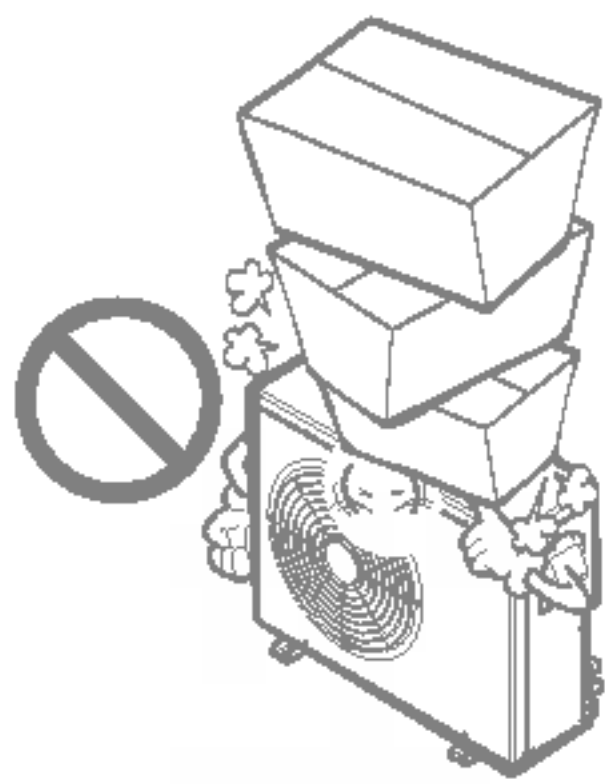

Always insert the filter securely. Clean the filter every two weeks or more often if necessary.

- A dirty filter reduces the efficiency of the air conditioner and could cause product malfunction or damage.

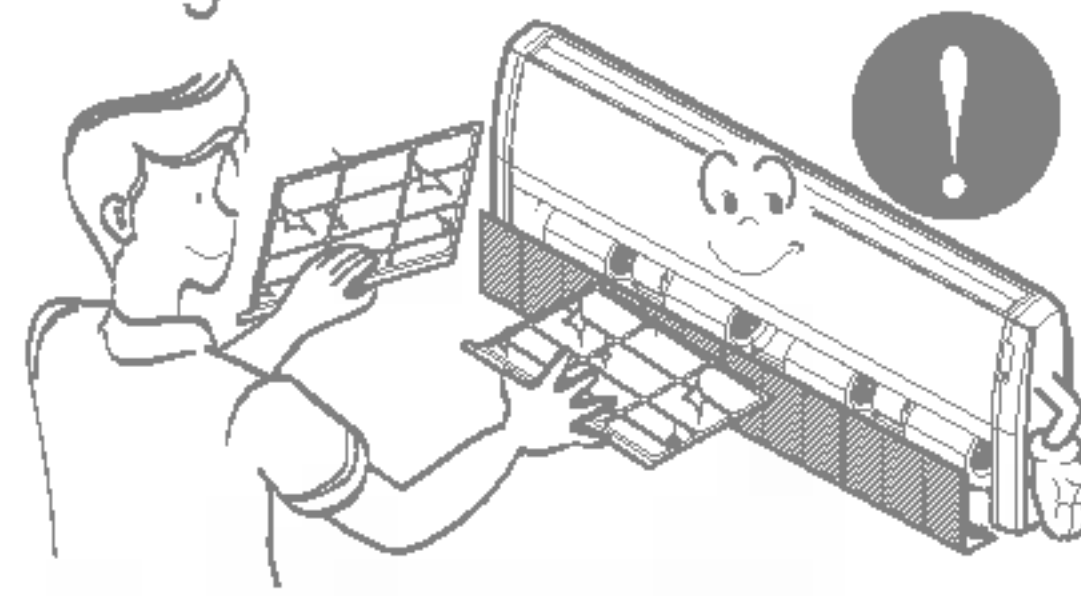

Do not insert hands or other objects through the air inlet or outlet while the product is operated.

- There are sharp and moving parts that could cause personal injury.

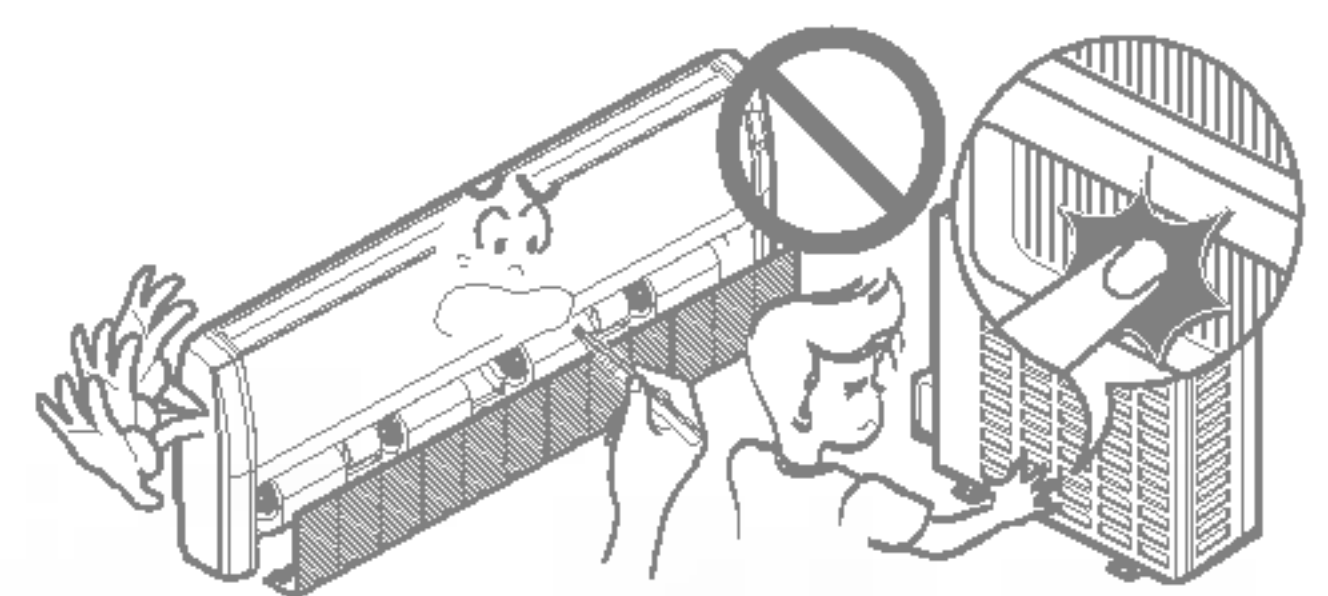

Do not drink the water drained from the product.

- It is not sanitary and could cause serious health issues.

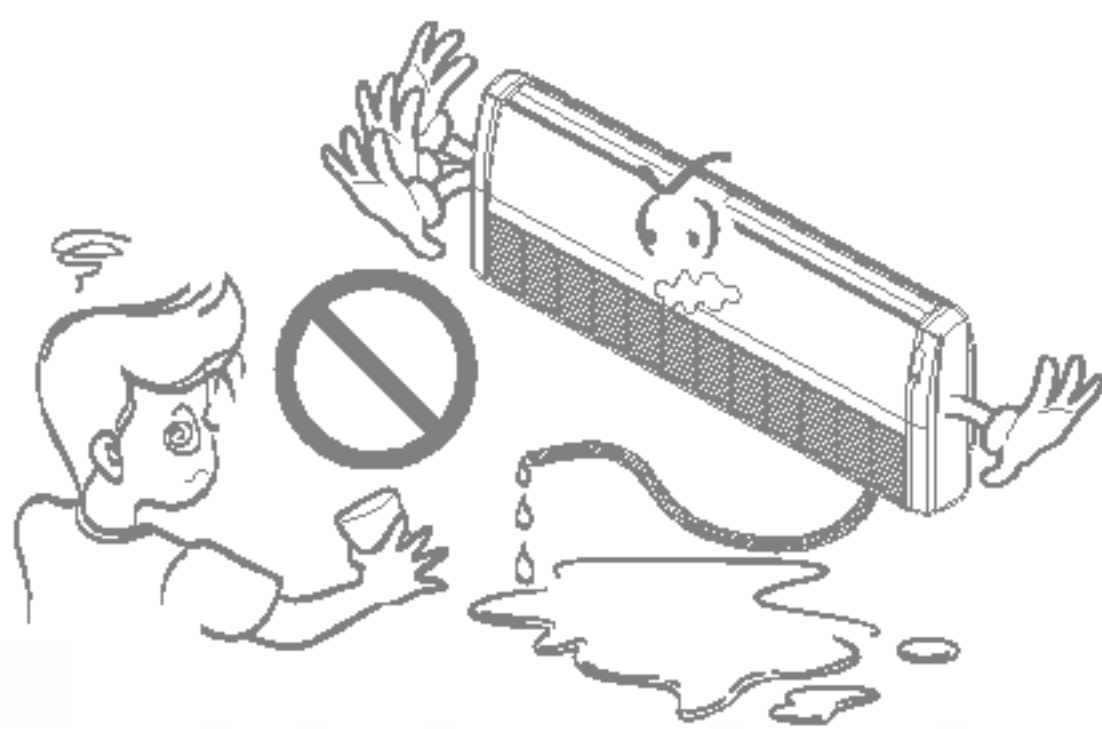

Use a firm stool or ladder when cleaning or maintaining the product.

- Be careful and avoid personal injury.

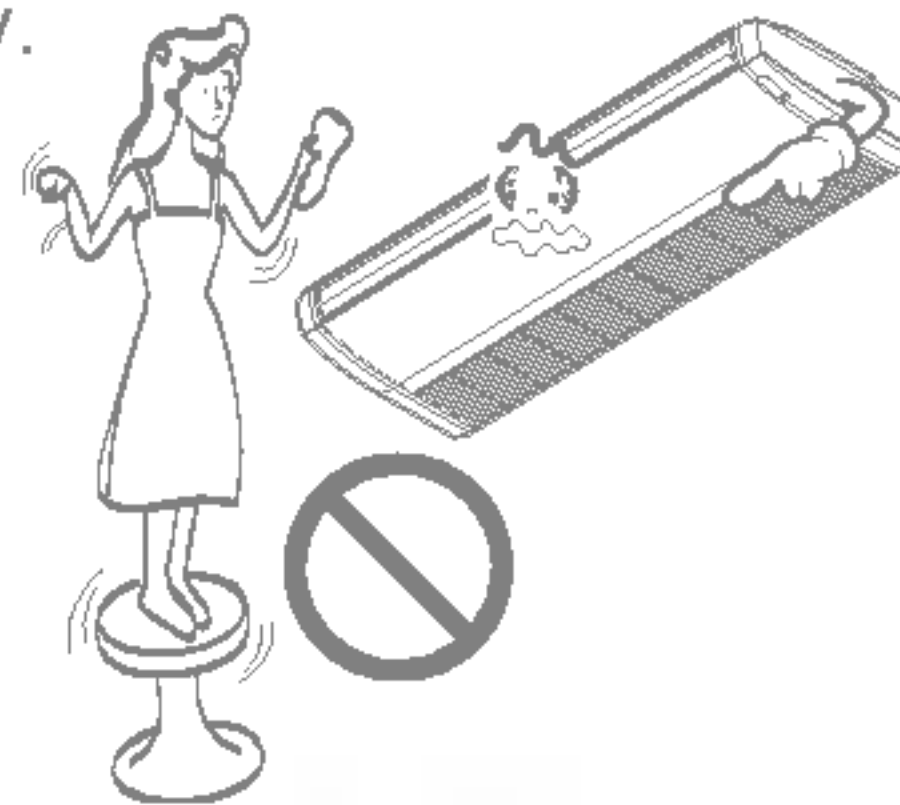

Replace the all batteries in the remote control with new ones of the same type. Do not mix old and new batteries or different types of batteries.

- There is risk of fire or explosion

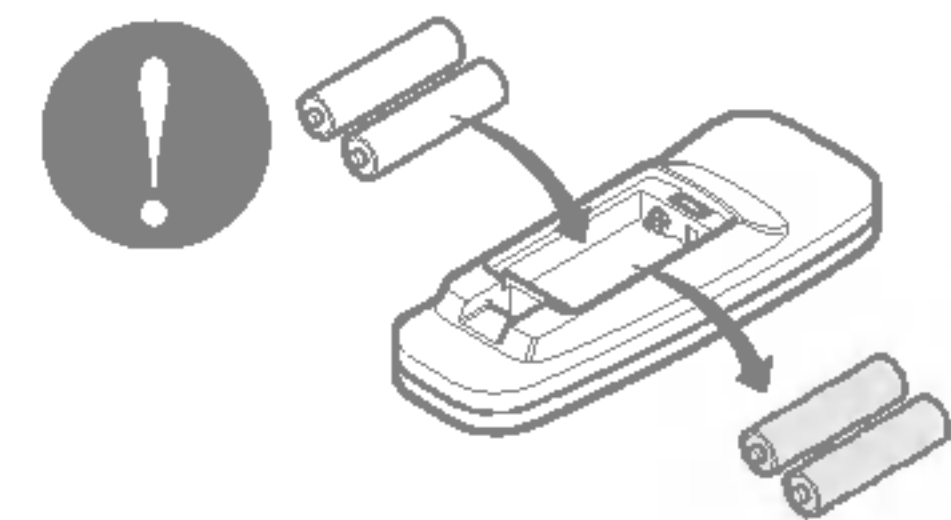

Do not recharge or disassemble the batteries. Do not dispose of batteries in a fire.

- They may burn or explode.

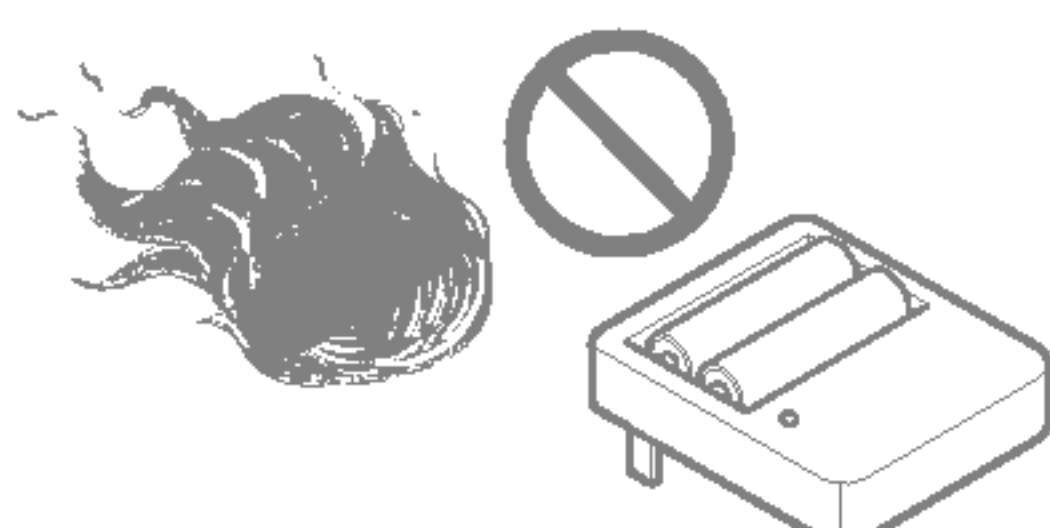

If the liquid from the batteries gets onto your skin or clothes, wash it well with clean water. Do not use the remote if the batteries have leaked.

- The chemicals in batteries could cause burns or other health hazards.

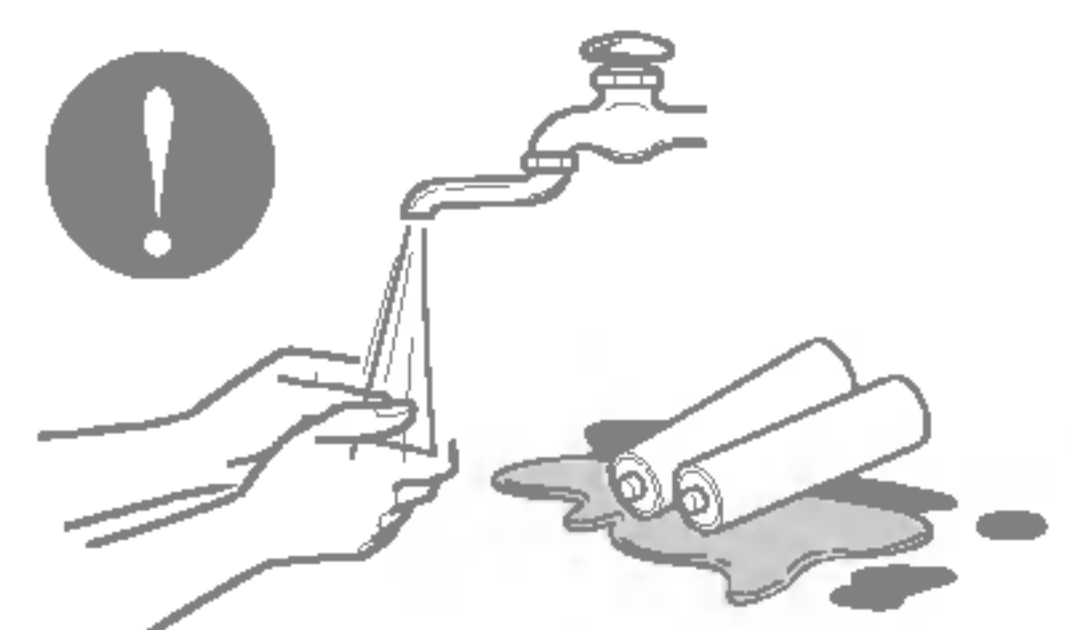

1. Contact an installation specialist for installation.
2. Connect the power cable between indoor unit and outdoor unit properly.
3. Use a dedicated circuit.
4. If the cord/plug is damaged, replace it with only an authorized replacement part.

1. Being exposed to direct airflow for an extended period of time could be hazardous to your health. Do not expose occupants, pets, or plants to direct airflow for extended periods of time.
2. Due to the possibility of oxygen deficiency, ventilate the room when used together with stoves or other heating devices.
3. Do not use this air conditioner for non-specified special purposes (e.g. preserving precision devices, food, pets, plants, and art objects). Such usage could damage the items.

1. Do not touch the metal parts of the unit when removing the filter. Injuries can occur when handling sharp metal edges.
2. Do not use water to clean inside the air conditioner. Exposure to water can destroy the insulation, leading to possible electric shock.
3. When cleaning the unit, first make sure that the power and breaker are turned off. There is a possibility of injury if the unit's power is accidentally triggered on while cleaning inner parts of the unit.

For repair and maintenance, contact your authorized service dealer.



This symbol alerts you to the risk of electric shock.



This symbol alerts you to hazards that could cause harm to the air conditioner.



This symbol indicates special notes.

1. Remove the battery cover by pulling it according to the arrow direction.
2. Insert new batteries making sure that the (+) and (-) of battery are installed correctly.
3. Reattach the cover by sliding it back into position.

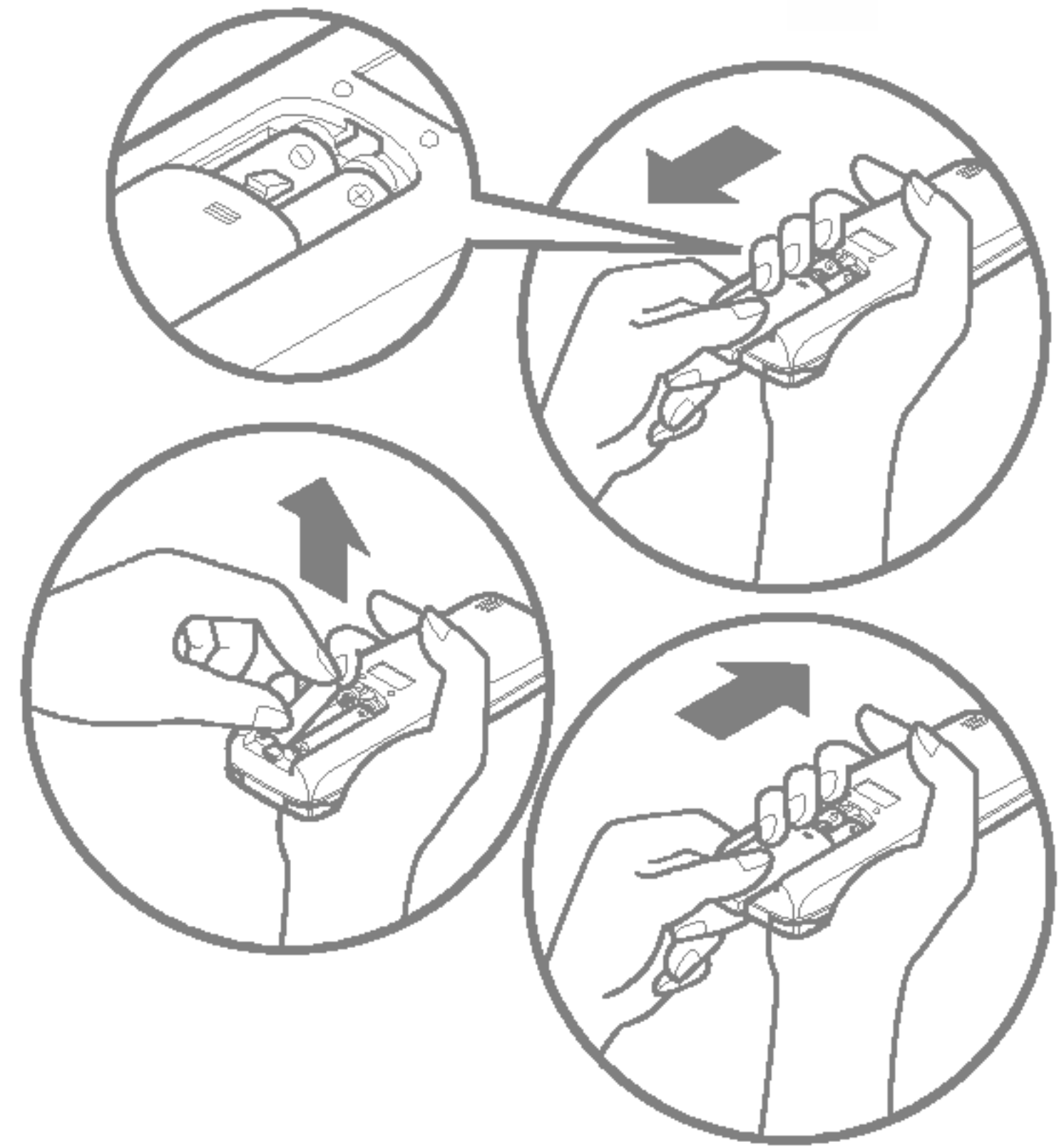

: Use 2 AAA(1.5volt) batteries. Do not use rechargeable batteries.

Storage and Tips For Using the Remote Controller

- The remote controller may be stored by mounting it on a wall.
- To operate the room air conditioner, aim the Remote Controller to the signal receptor.

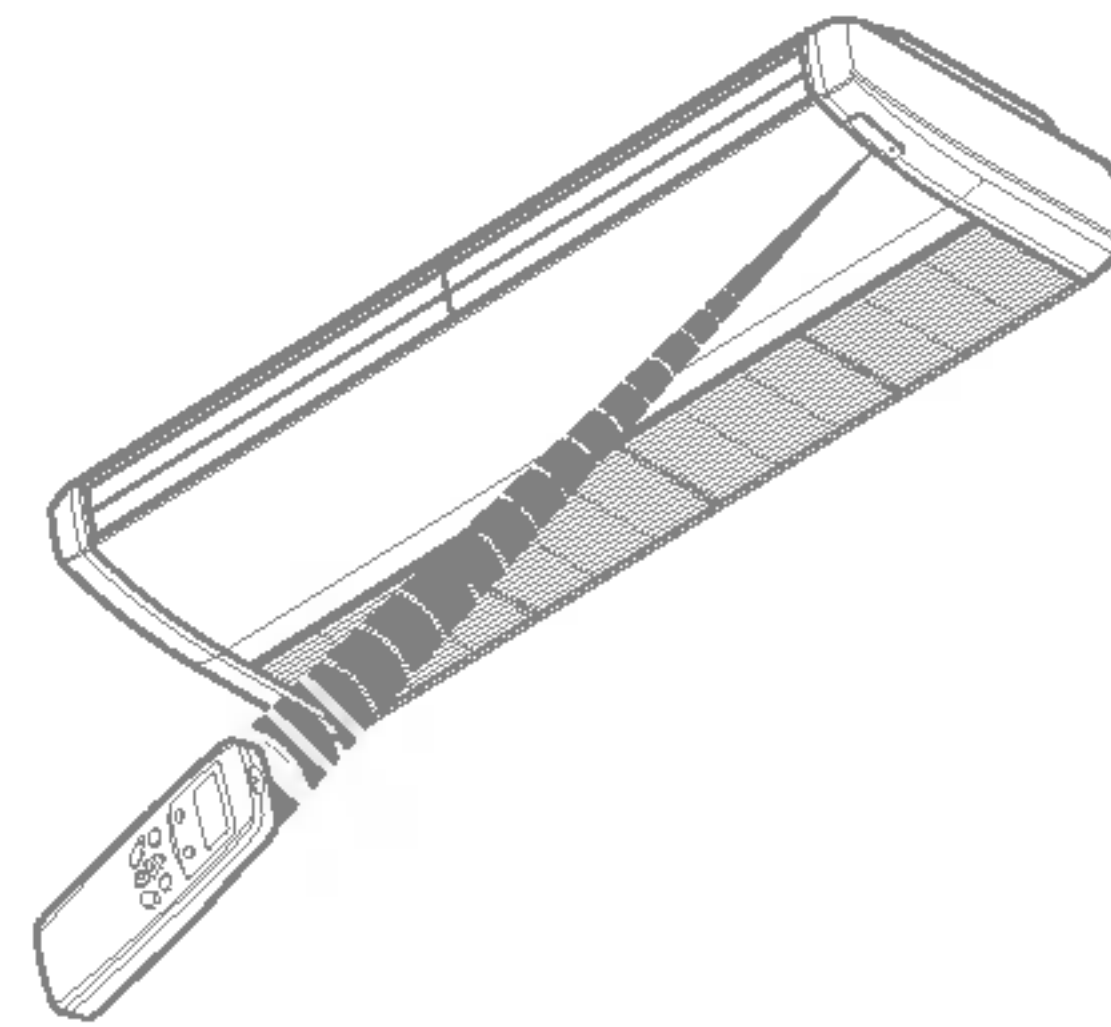
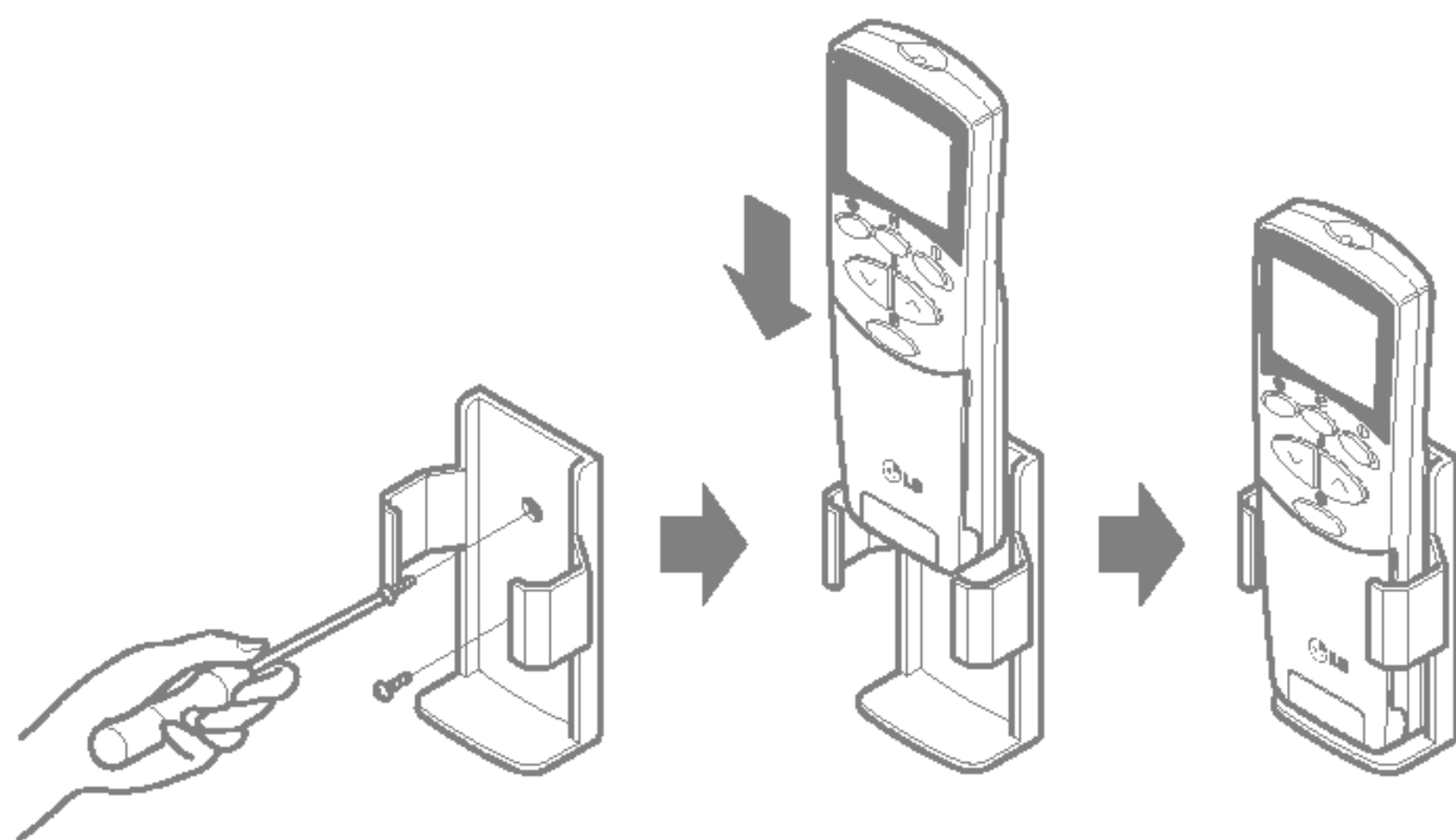

Signal Receptor

Receives the signals from the remote controller.(Signal receiving sound: two short beeps or one long beep.)

Operation Indication Lamps

- | | | |
|--|-------------------------------|---|
| | On/Off | : Lights up during the system operation. |
| | Filter Sign | : Lights up after 2400 hours from the time of first operating unit. |
| | Timer | : Lights up during Timer operation. |
| | Outdoor Unit Operation | : Light up during outdoor unit operation. (Cooling model only) |
| | Defrost Mode | : Lights up during Defrost Mode or Hot Start operation.(Heat pump model only) |

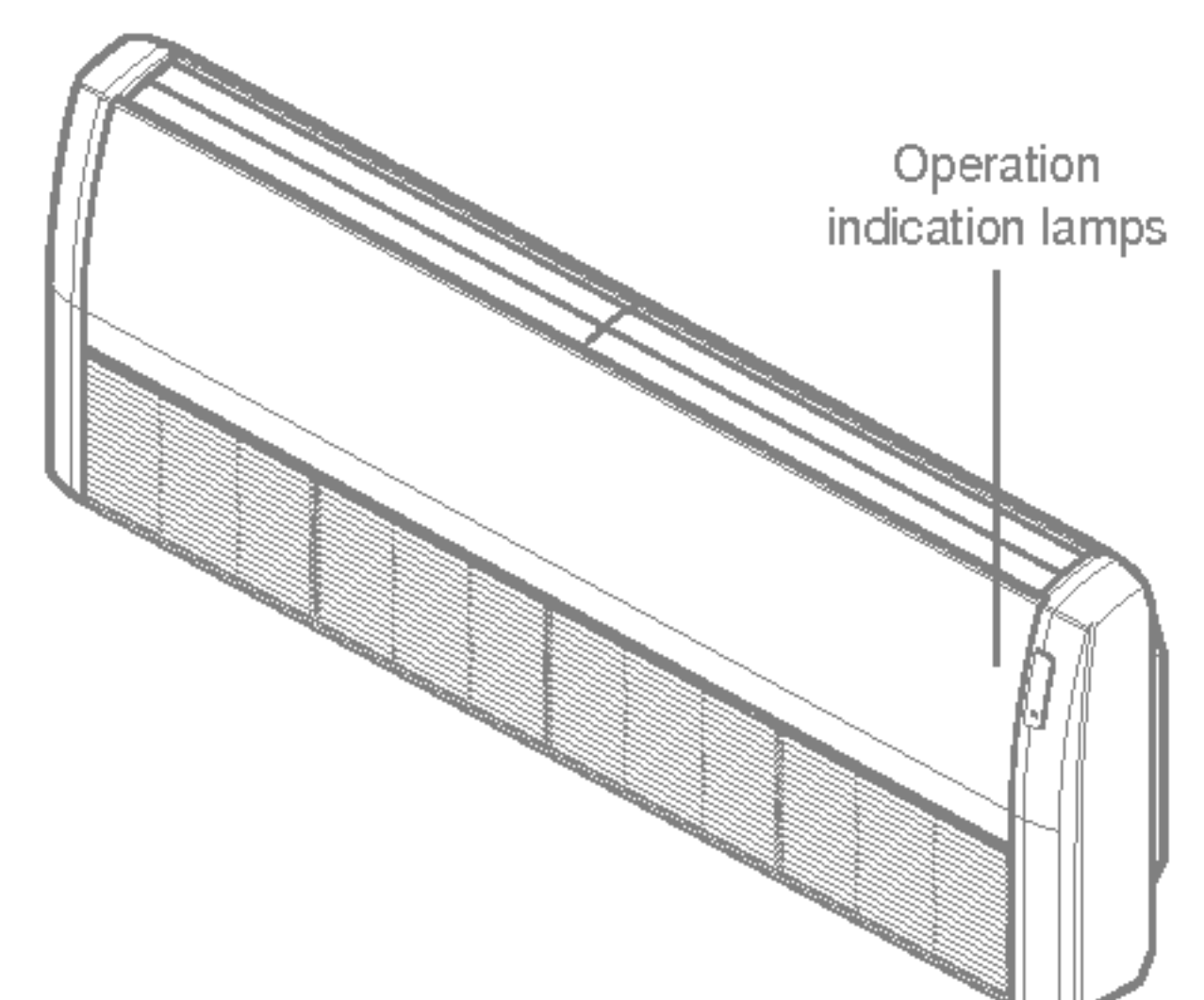

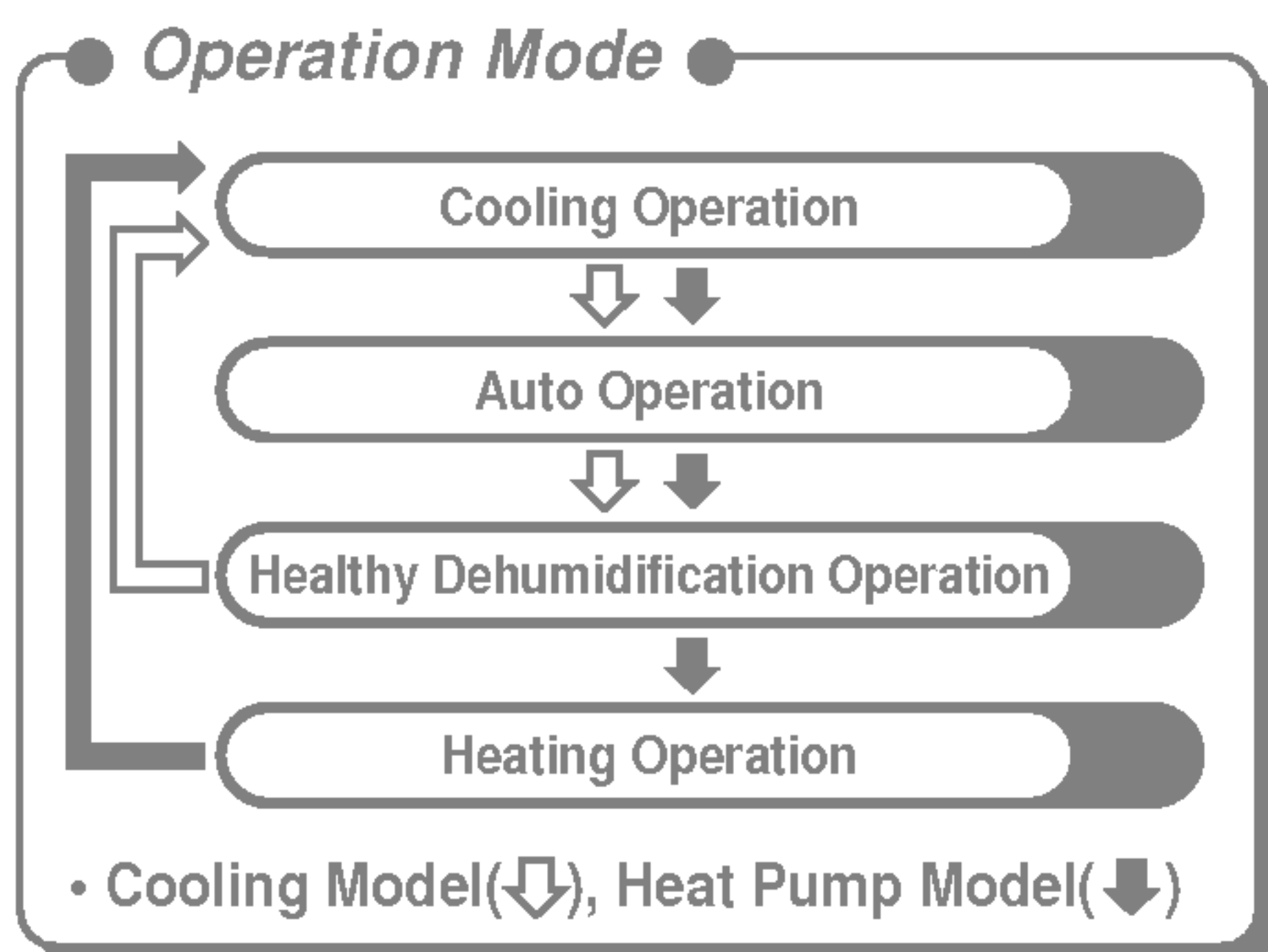
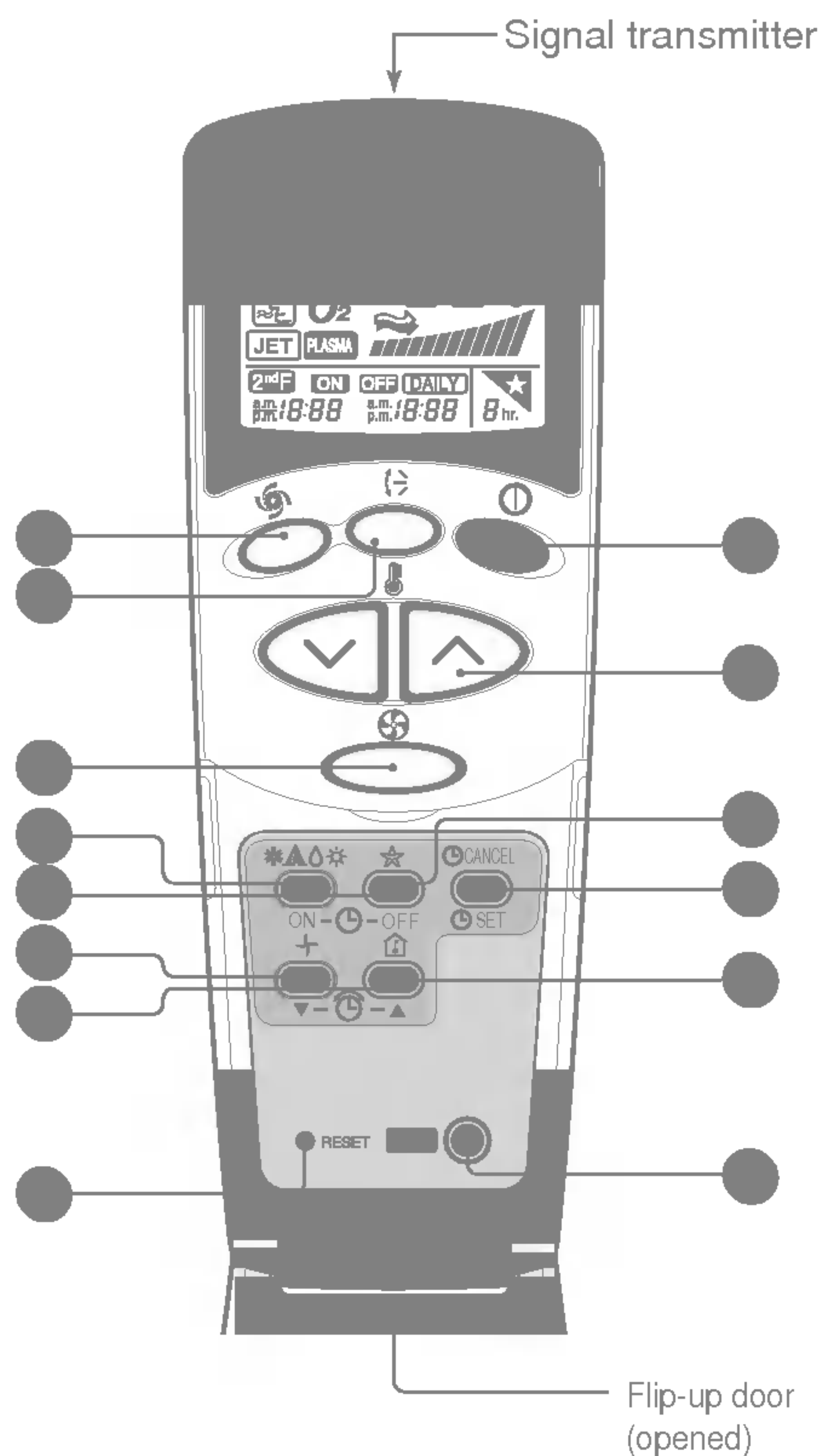

The Remote Controller transmits the signals to the system.



- START/STOP BUTTON**
Operation starts when this button is pressed and stops when the button is pressed again.

- OPERATION MODE SELECTION BUTTON**
Used to select the operation mode.



- ROOM TEMPERATURE SETTING BUTTONS**
Used to select the room temperature.

- INDOOR FAN SPEED SELECTOR**
Used to select fan speed in four steps low, medium, high and CHAOS.



- JET COOL BUTTON**
Used to select jet cool mode.

- CHAOS SWING BUTTON**
Used to stop or start louver movement and set the desired up/down airflow direction.



- ON/OFF TIMER BUTTONS**
Used to set the time of starting and stopping operation.
- TIME SETTING BUTTONS**
Used to adjust the time.
- TIMER SET/CANCEL BUTTON**
Used to set the timer when the desired time is obtained and to cancel the Timer operation.
- SLEEP MODE AUTO BUTTON**
Used to set Sleep Mode Auto operation.
- AIR CIRCULATION BUTTON**
Used to circulate the room air without cooling or heating.
- ROOM TEMPERATURE CHECKING BUTTON**
Used to check the room temperature.
- RESET BUTTON**
Initialize remote controller.
- 2nd F Button**
Used prior to using modes printed in blue at the bottom of buttons.

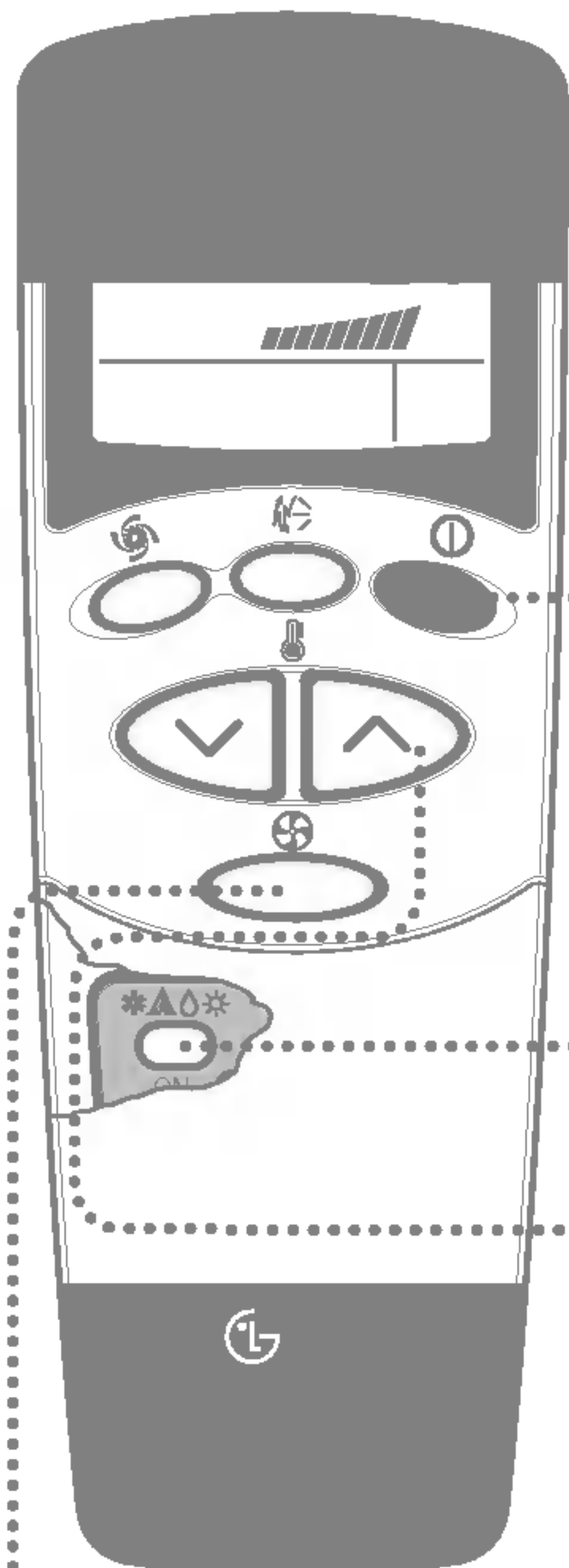

Cooling Operation

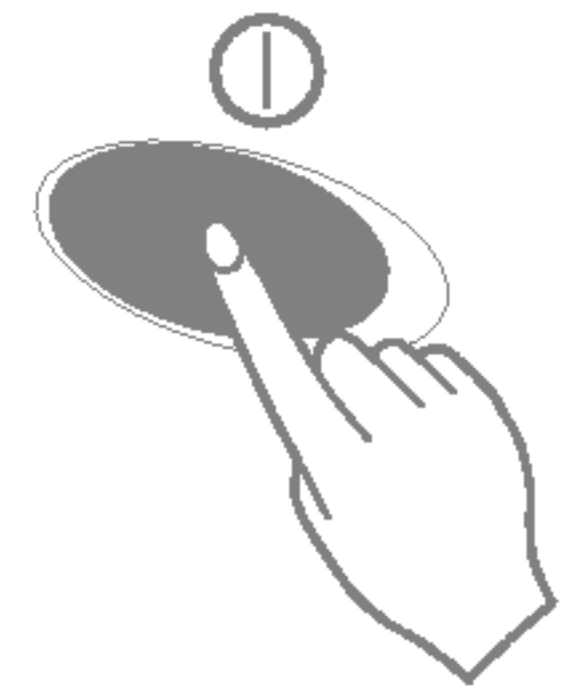

- 1** Press the Start/Stop button. The unit will respond with a beep.



- 2** Open the door on the remote control. To select **Cooling Operation**, press the Operation Mode Selection button. Each time the button is pressed, the operation mode is shifted in the direction of the arrow.

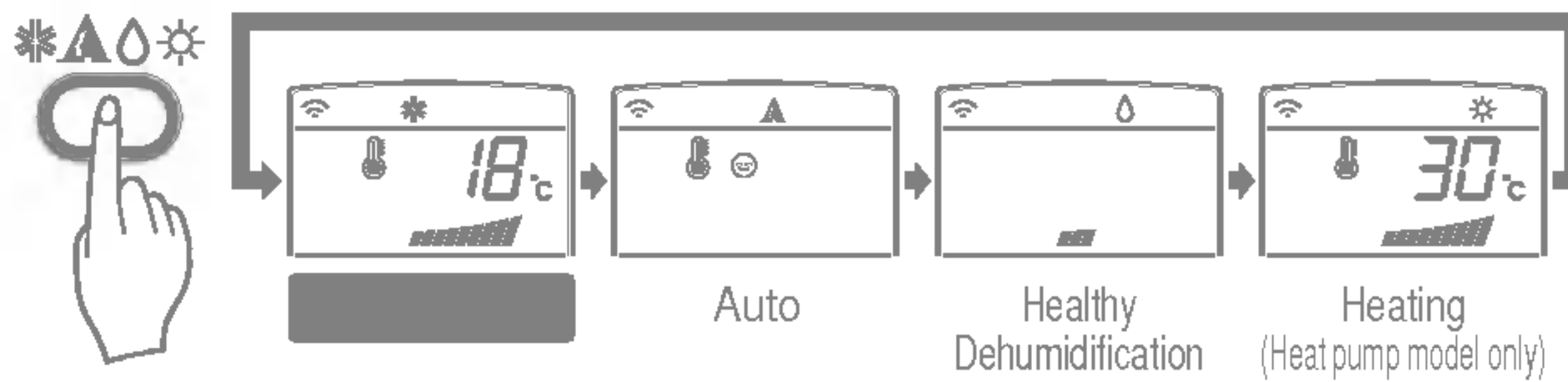

- 3** Close the door on the remote control. Set the temperature lower than the room temperature. The temperature can be set within a range of 18°C~30°C in 1°C increments.

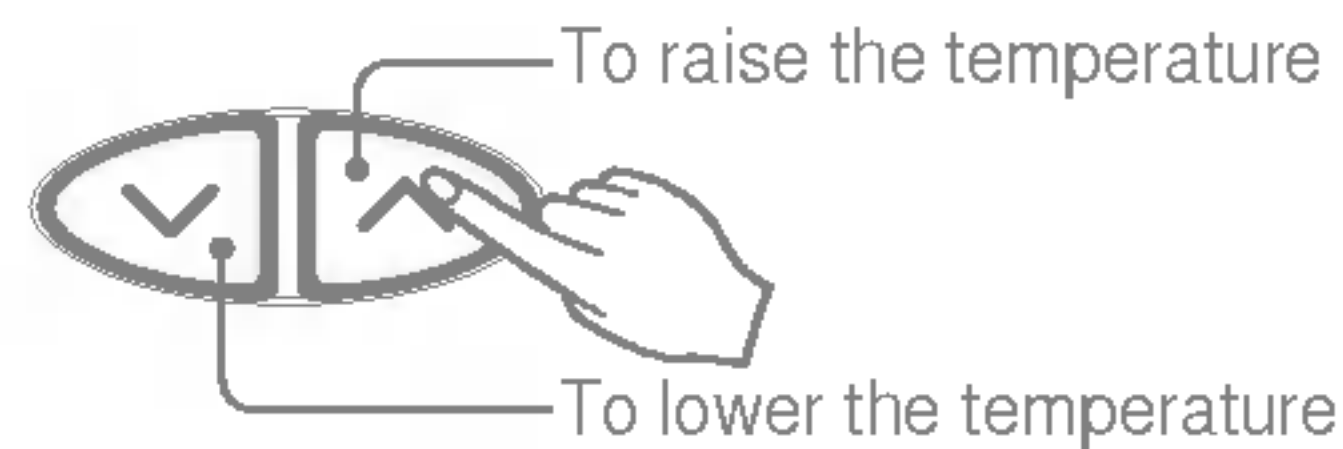

- 4** Set the fan speed again with the door of the remote control still closed. You can select the fan speed in four steps—low, medium, high and CHAOS. Each time the button is pressed, the fan speed mode is shifted.



Natural wind by the CHAOS logic

- For more fresh feeling than other fan speed, press the Indoor Fan Speed Selector and set to CHAOS mode. In this mode, the wind blows like natural breeze by automatically changing fan speed according to the CHAOS logic.



Auto Operation

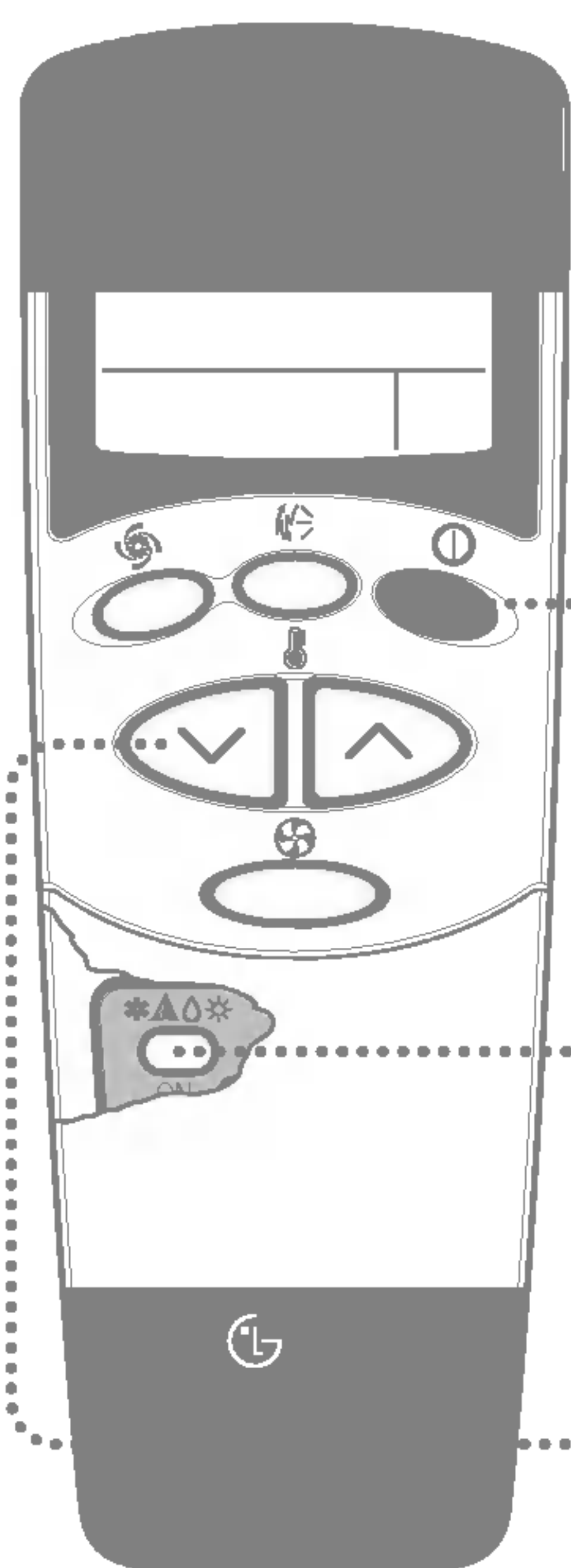

- 1** Press the Start/Stop button. The unit will respond with a beep.



- 2** Open the door on the remote control. To select **Auto Operation**, press the Operation Mode Selection button. Each time the button is pressed, the operation mode is shifted in the direction of the arrow.

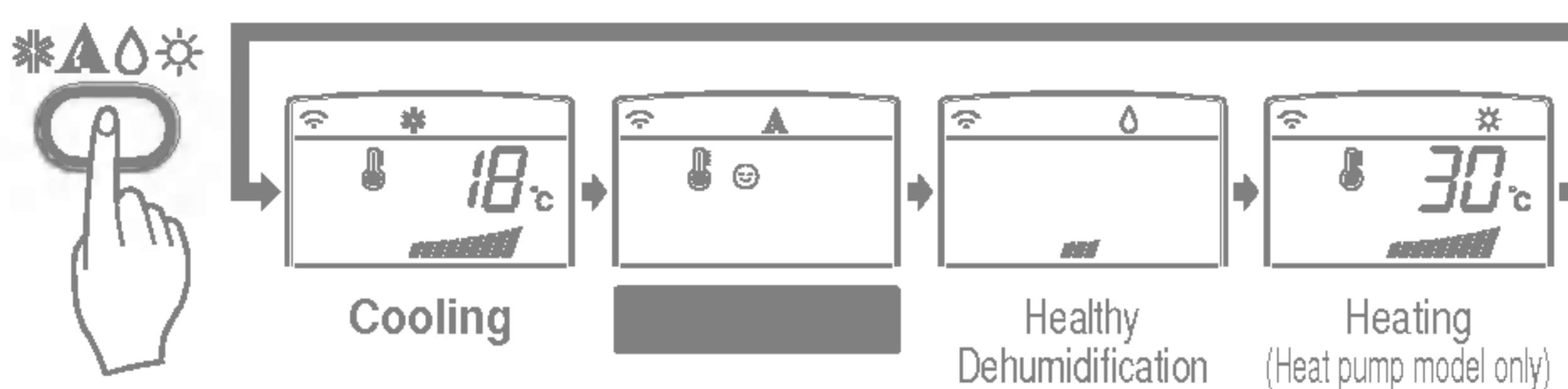

- 3** The temperature and fan speed are automatically set by the electronic controls based on the actual room temperature. If you want to change the set temperature, press the Room Temperature Setting buttons. The cooler or warmer you feel, the more times (up to two times) you should press the button. The set temperature will be changed automatically.

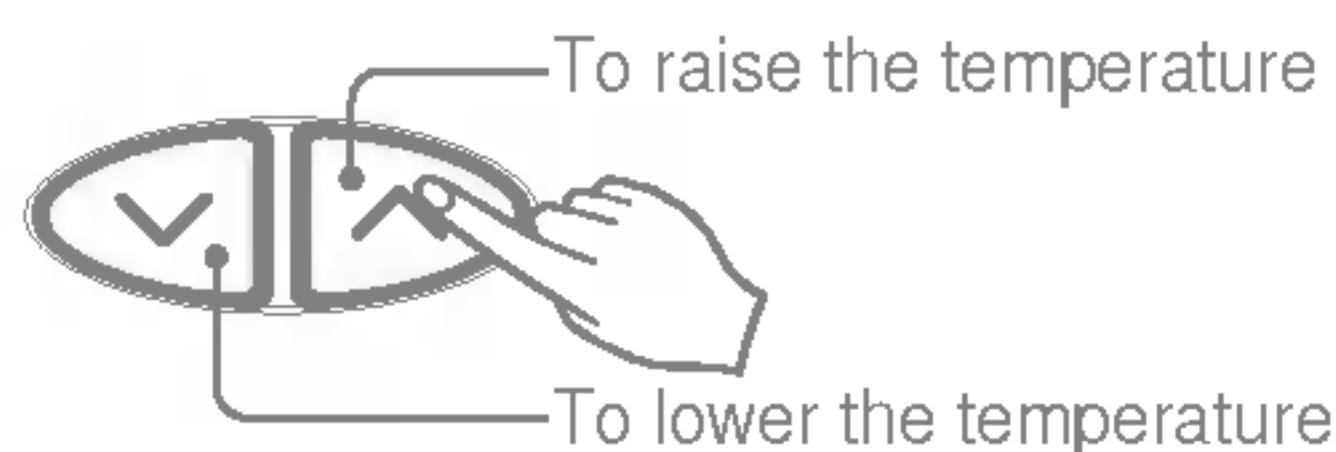

During Auto Operation:

- You cannot switch the indoor fan speed. It has already been set by the Fuzzy rule.
- If the system is not operating as desired, manually switch to another mode. The system will not automatically switch from the cooling mode to the heating mode, or from heating mode to cooling mode, it must be done by manually resetting.
- During Auto Operation, pressing the chaos swing button makes the horizontal louvers swing up and down automatically. If you want to stop auto-swing, press the chaos swing button again.



Healthy Dehumidification Operation

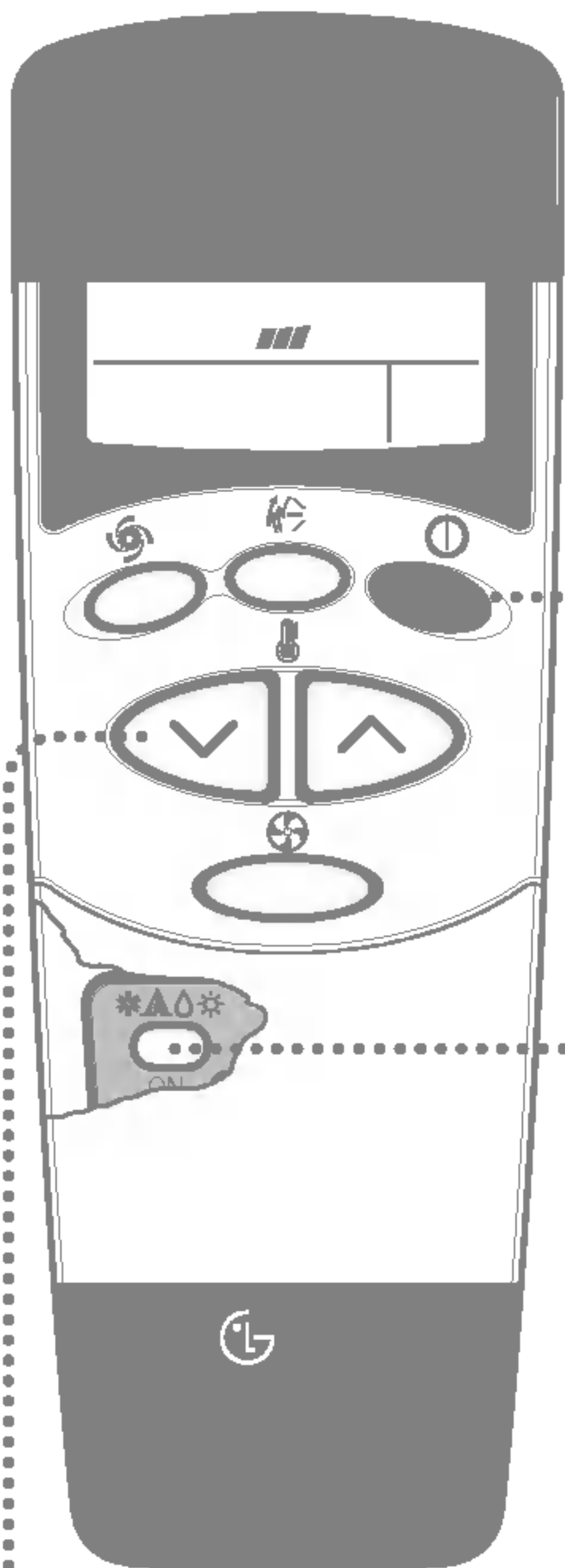

- 1** Press the Start/Stop button. The unit will respond with a beep.

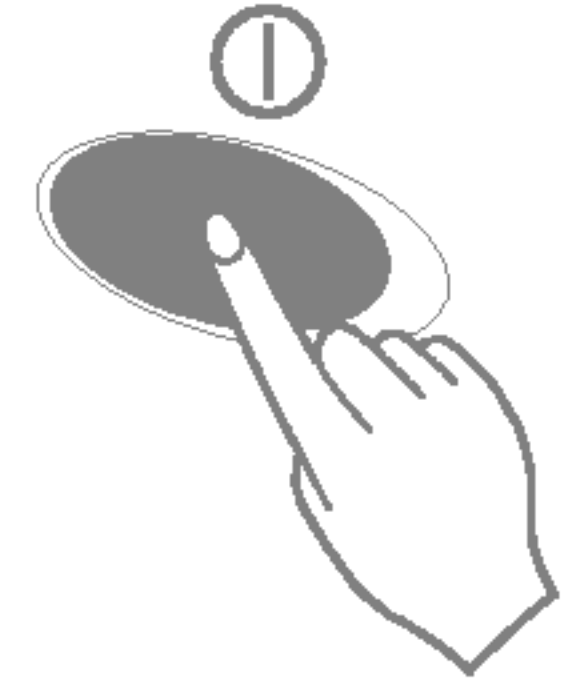

- 2** Open the door on the remote control. To select **Healthy Dehumidification Operation**, press the Operation Mode Selection button. Each time the button is pressed, the operation mode is shifted in the direction of the arrow.

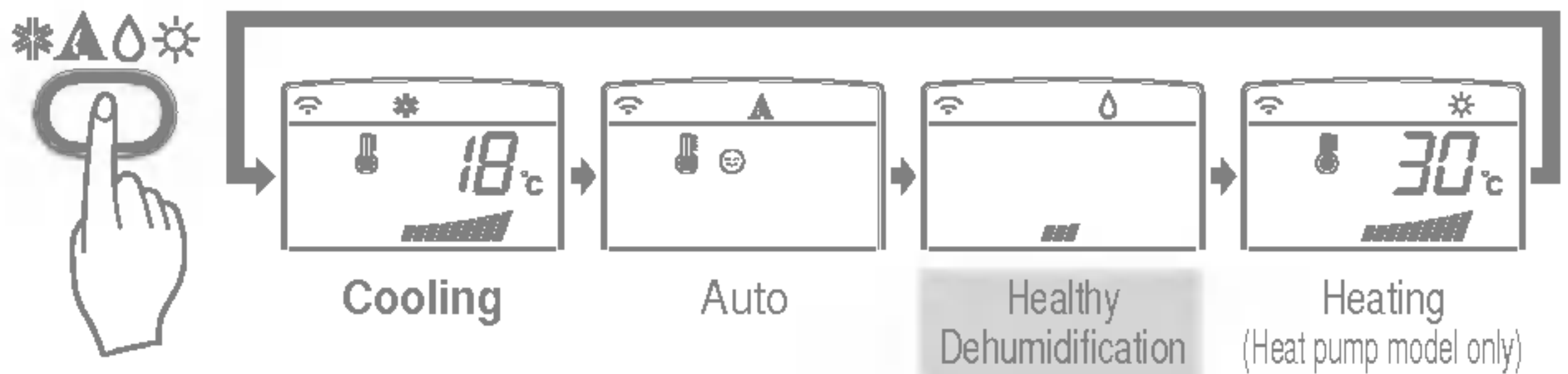

- 3** Set the fan speed again with the door of the remote control still closed. You can select the fan speed in four steps—low, medium, high, or CHAOS. Each time the button is pressed, the fan speed mode is shifted.

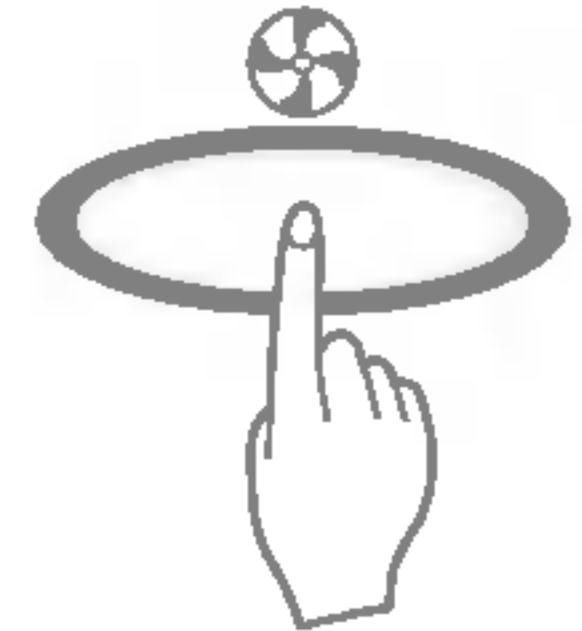

Natural wind by the CHAOS logic

- For more fresh feeling than other fan speed, press the Indoor Fan Speed Selector and set to CHAOS mode. In this mode, the wind blows like natural breeze by automatically changing fan speed according to the CHAOS logic.

During Healthy Dehumidification Operation:

- If you select the dehumidification mode on the operation selection button, the A/C starts to run the dehumidification function. It automatically sets the room temp. and airflow volume to the best condition for dehumidification, based on the sensed current room temp.

In this case, however, the setting temp. is not displayed in the remote control and you are not able to control the room temp. either.

- During the healthy dehumidification function, the airflow volume is automatically set according to the optimization algorithm responding to the current room temp. status which makes the room condition healthy and comfortable even in the high humidity season.



Heating Operation(Heat pump model only)

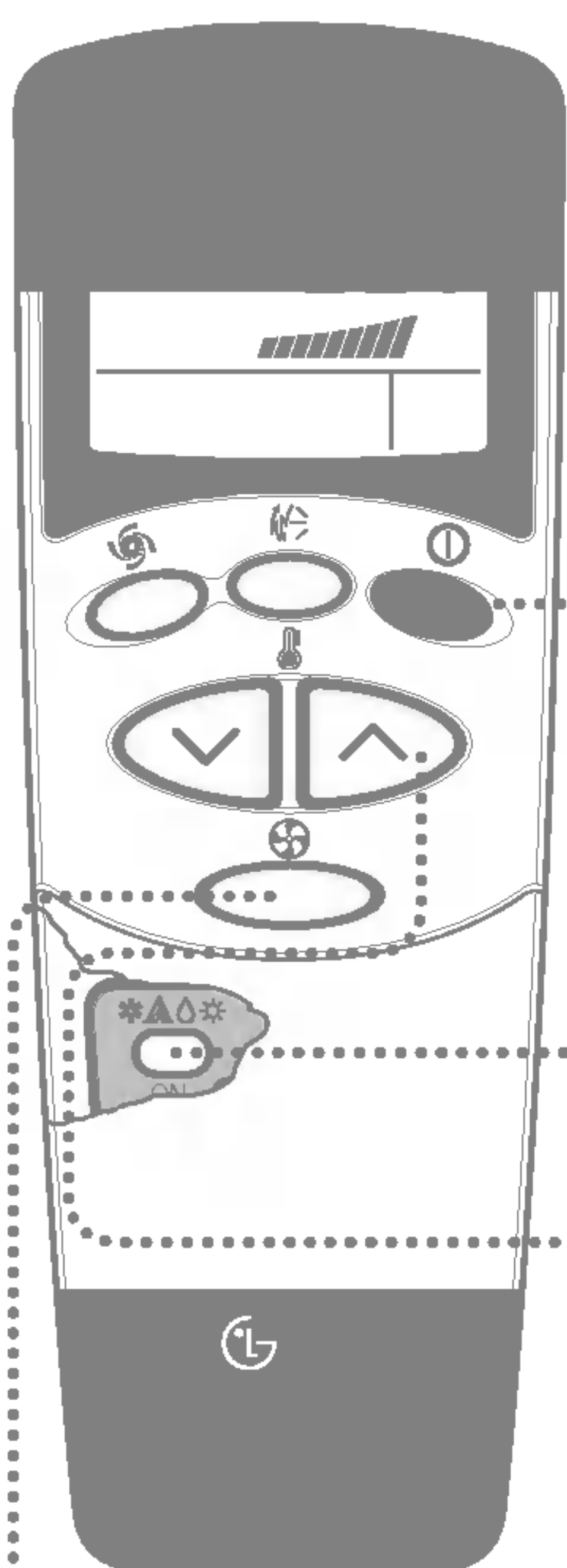

- 1** Press the Start/Stop button.
The unit will respond with a beep.

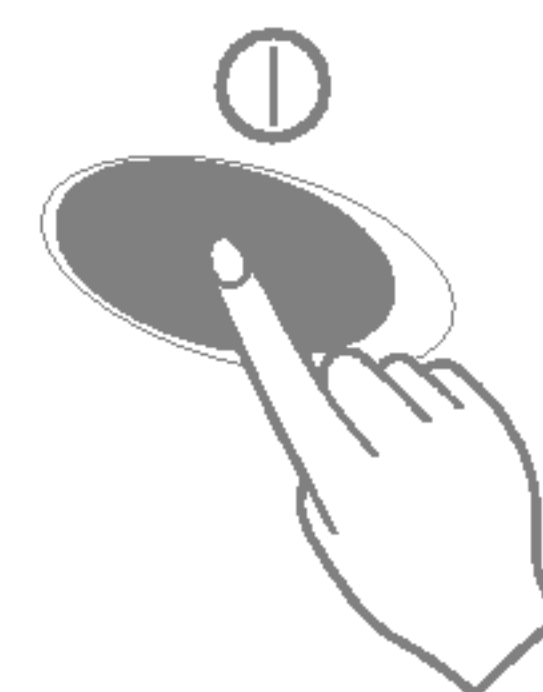

- 2** Open the door on the remote control. To select **Heating Operation**, press the Operation Mode Selection button. Each time the button is pressed, the operation mode is shifted in the direction of the arrow.

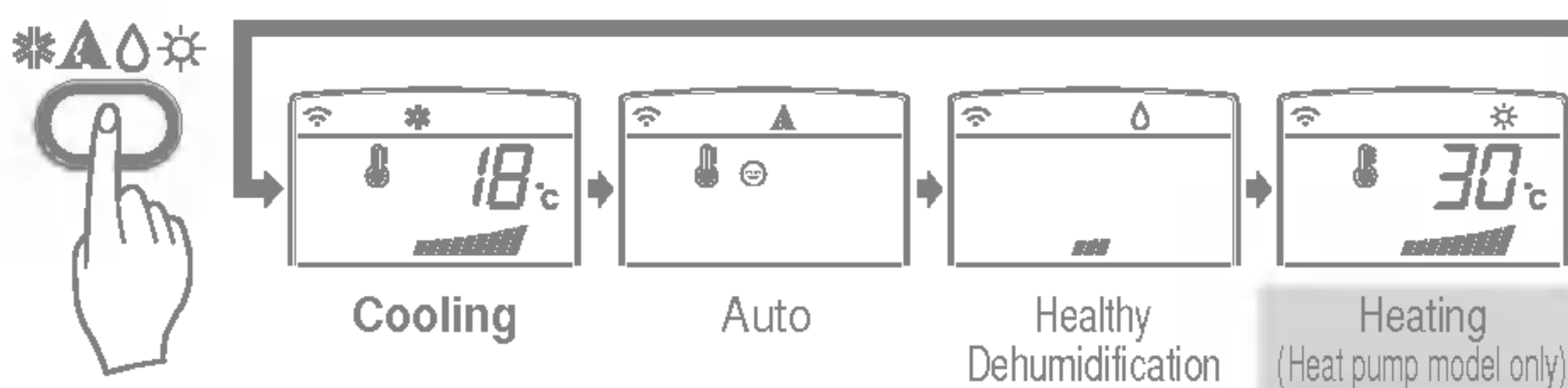

- 3** Close the door on the remote control. Set the temperature higher than the room temperature. The temperature can be set within a range of 16°C~30°C in 1°C increments.

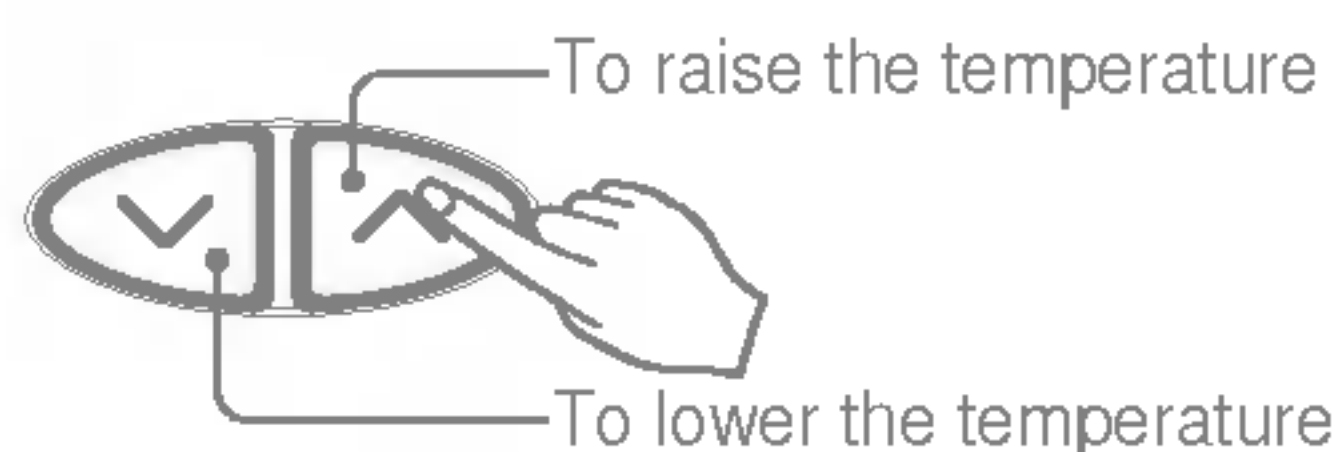

- 4** Set the fan speed again with the door of the remote control still closed. You can select the fan speed in four steps—low, medium, high and CHAOS. Each time the button is pressed, the fan speed mode is shifted.

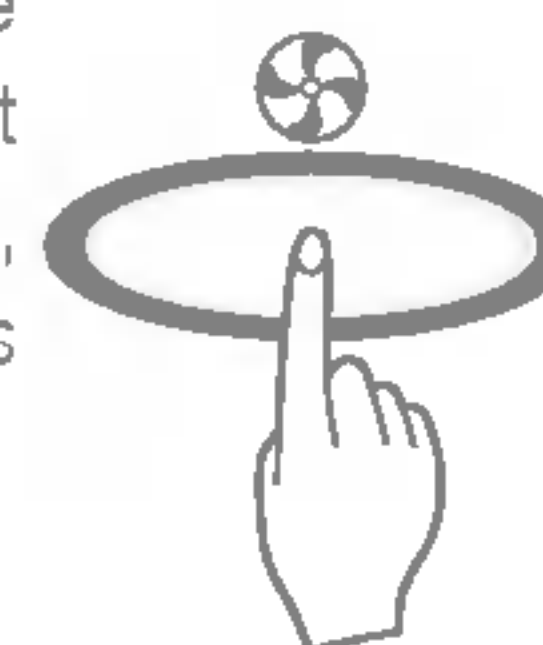

Natural wind by the CHAOS logic

- For more fresh feeling than other fan speed, press the Indoor Fan Speed Selector and set to CHAOS mode. In this mode, the wind blows like natural breeze by automatically changing fan speed according to the CHAOS logic.



Jet Cool Operation

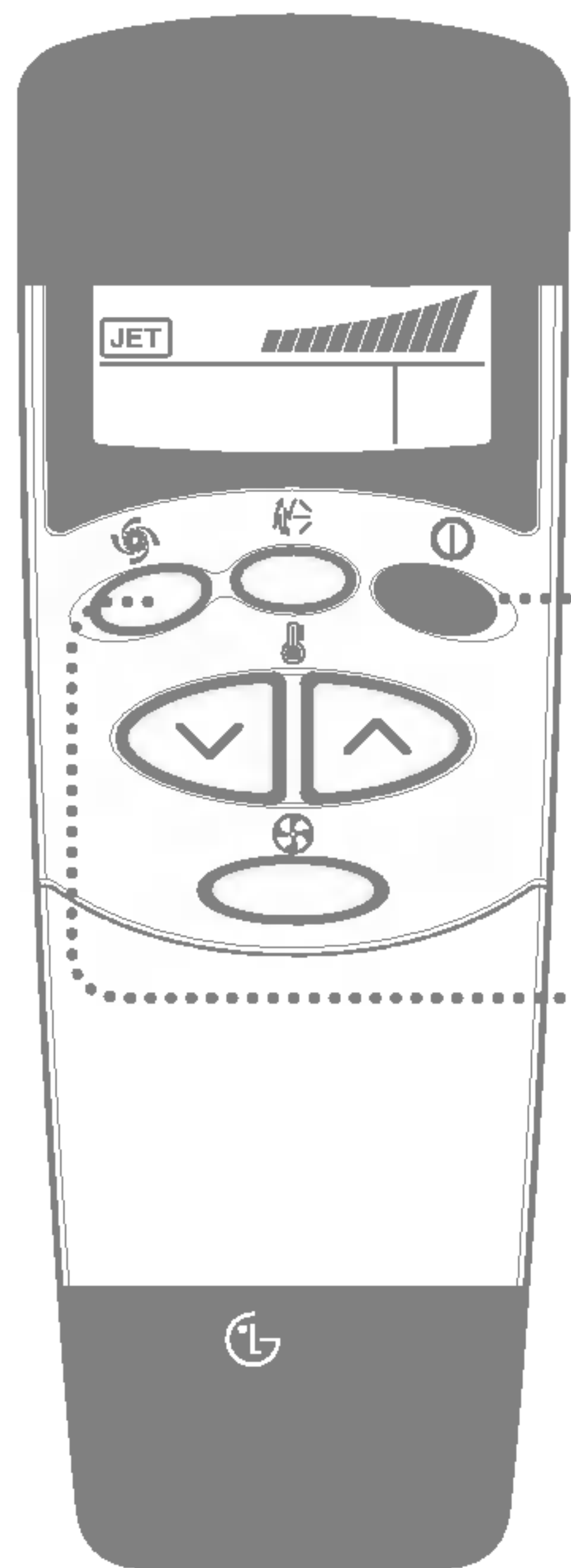

- 1** Press the Start/Stop button. The unit will respond with a beep.

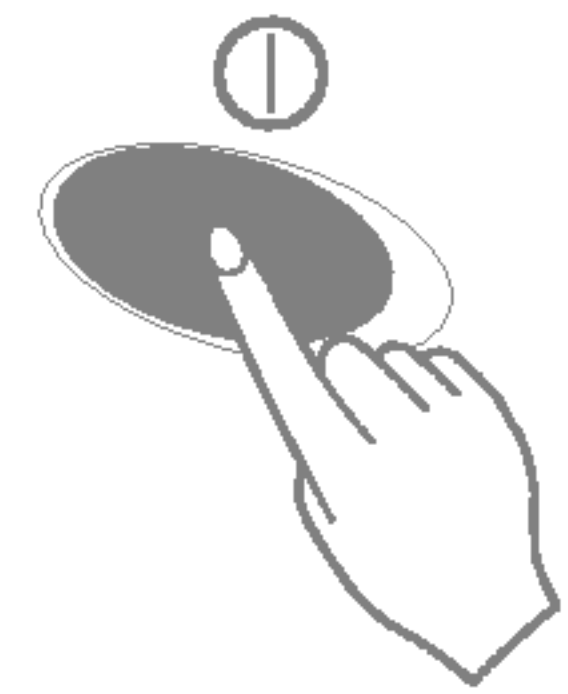

- 2** Press the **Jet Cool** button to operate the speed cooling mode and the unit will operate in super high fan speed on cooling mode for 30 minutes.



- 3** To cancel the **Jet Cool** mode, press the **Jet Cool** button or the fan speed button or the room temperature setting button again and the unit will operate in high fan speed on cooling mode.

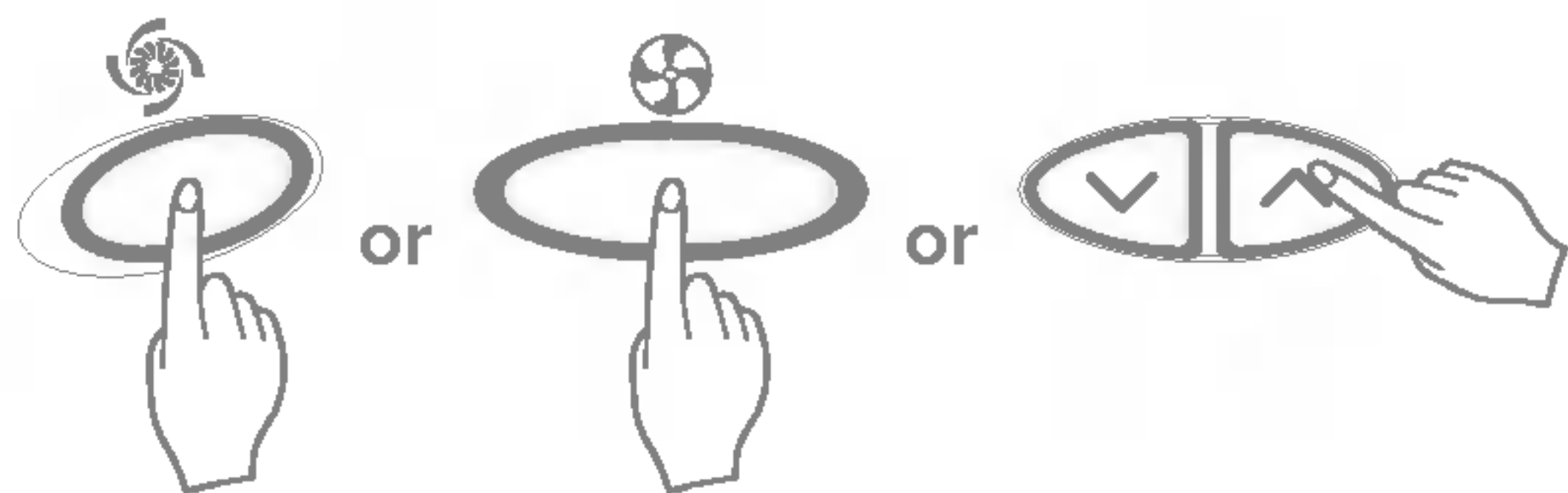

- During the JET COOL function at any moment, the A/C starts to blow the cool air at extremely high speed for 30 minutes setting the room temp. automatically to 18 °C. It is especially used to cool the room temp. in the shortest time in a hot summer. In heat pump mode or neuro fuzzy mode, however, the JET COOL function is not available.

- In order to return to the normal cooling mode from the JET COOL mode, you just press either the operation mode selection button, airflow volume selection or temp. setting button or the JET COOL button again.

2ndF 2nd F Operation

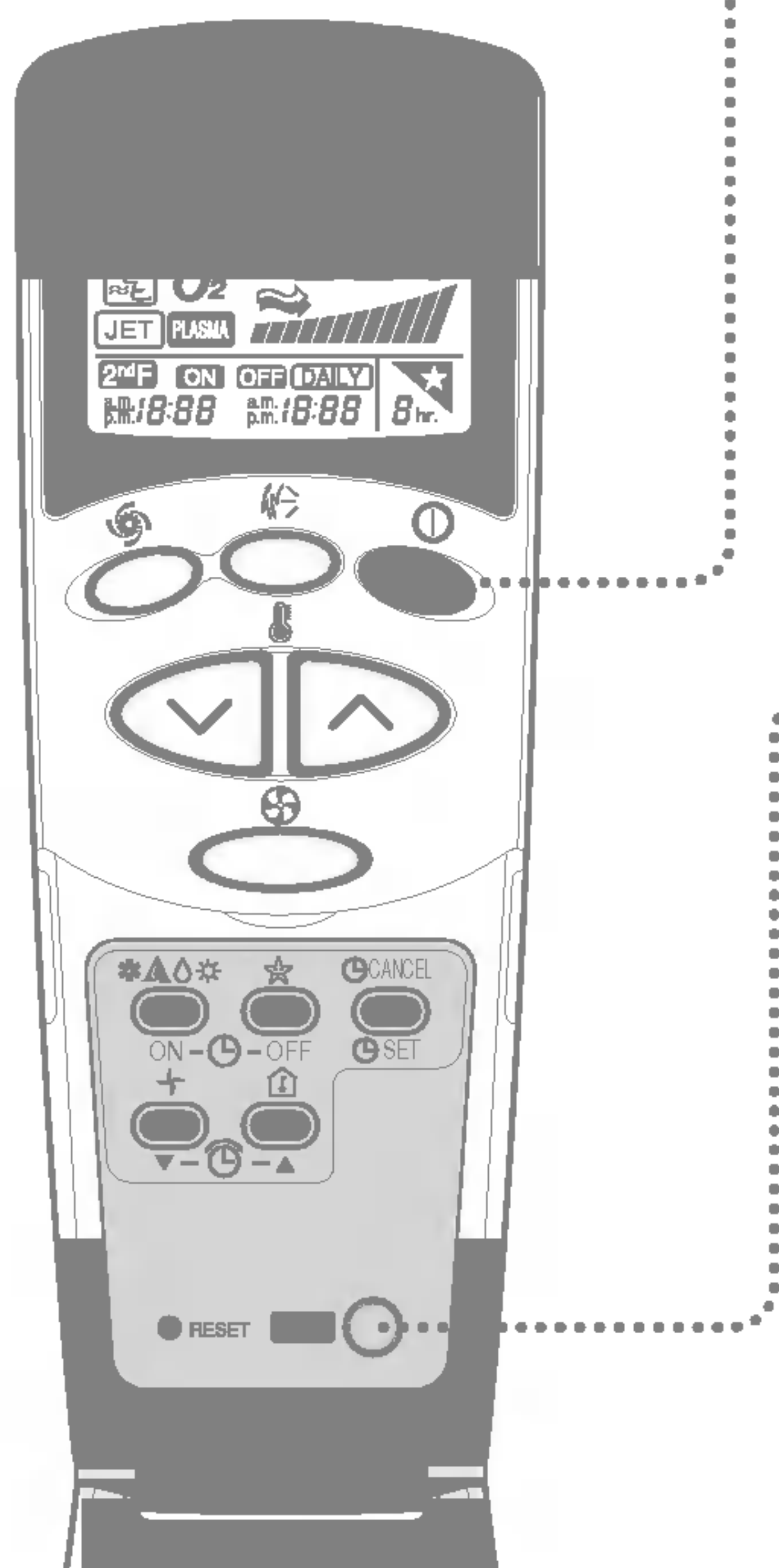

- 1 Press the Start/Stop button.
The unit will respond with a beep.

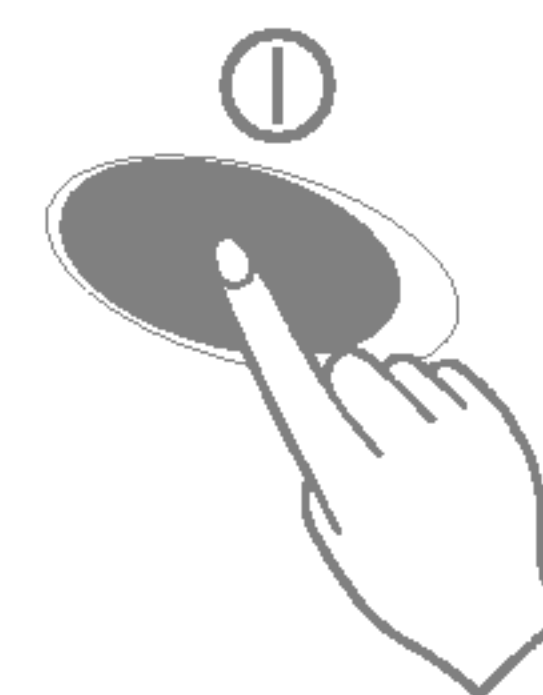

- 2 Open the door of the remote control and press the 2nd Function button to operate functions printed in blue at bottom of buttons.
(Check the indication of 2nd function on remote control display.)
These buttons operate the timer setting as follows:

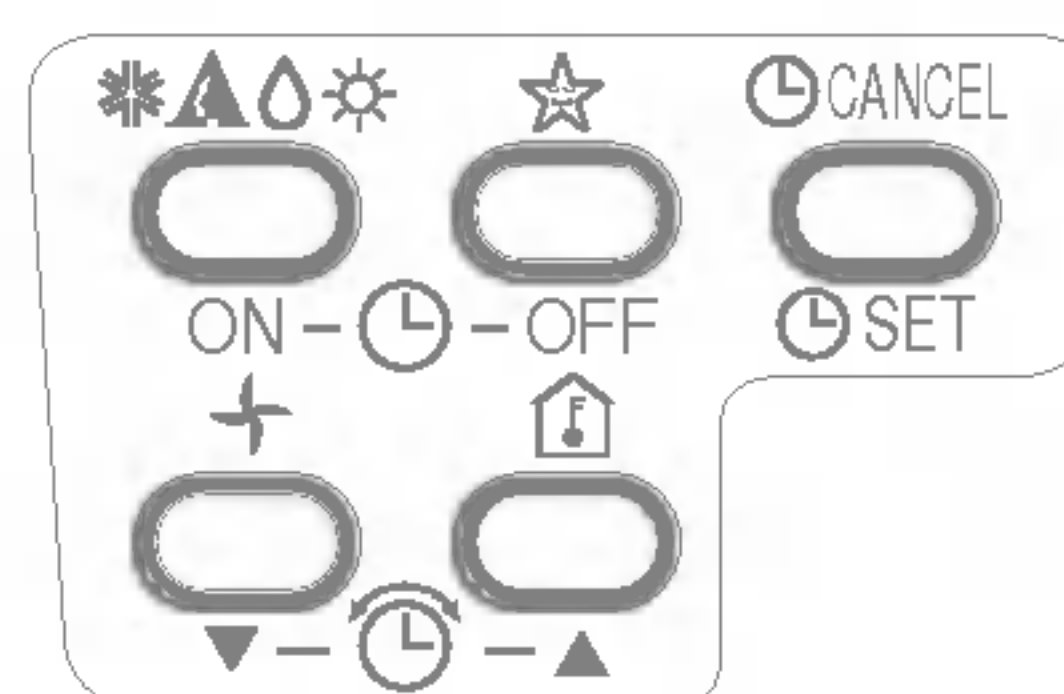

- 3 2nd function goes off in a short time automatically or when the button is pressed again.

For more details, refer to functions next page.

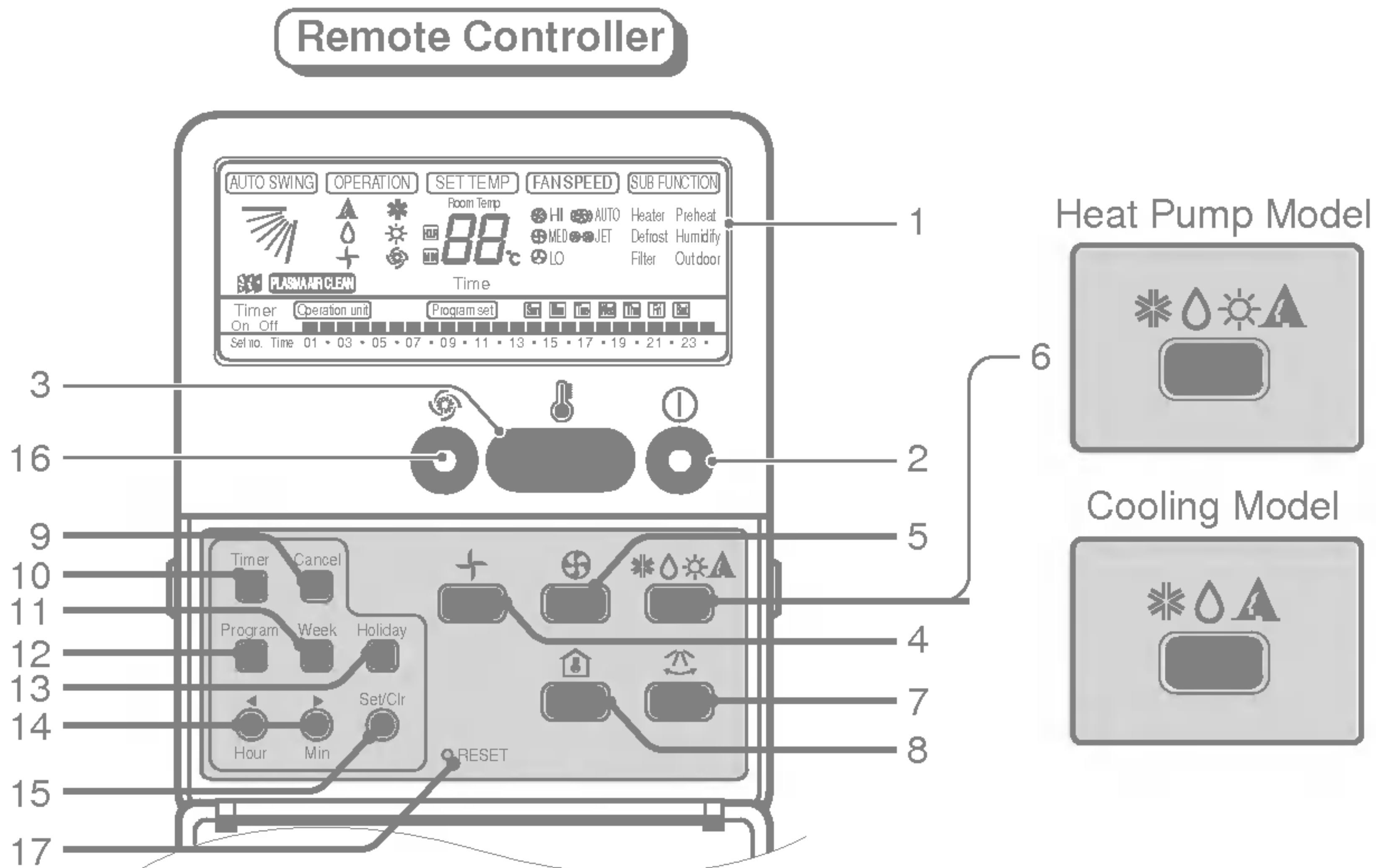

1. Operation display

Displays the operating conditions.

2. On/Off Button

Operation starts when this button is pressed, and stops when the button is pressed again.

3. Set Temperature Button

Used to set the temperature when the desired temperature is obtained.

4. FAN Operation Button

Used to circulate room air without cooling or heating.

5. Fan Speed Button

Used to set the desired fan speed.

6. Operation Mode Selection Button

Used to select the operation mode.

- Auto Operation Mode
- Cooling Operation Mode
- Healthy Dehumidification Operation
- Heating Operation Mode(except cooling model)

7. Auto Swing Button

Used to swing up and down.

8. Room Temperature Checking Button

Used to check the room temperature.

9. Timer Cancel Button

Used to cancel the timer.

10. Timer Set Button

Used to set the timer when the desired time is obtained.

11. Week Button

Used to set a day of the week.

12. Program Button

Used to set the weekly timer.

13. Holiday Button

Used to set a holiday of the week.

14. Time Set Button

Used to set the time of the day and change the time in the weekly timer Function.

15. Set and Clear Button

Used to set and clear the weekly timer.

16. Jet Cool Button

Used to select jet cool mode.

17. Reset Button

Used to set the current time and clear the setting time.



Sleep Mode

1. Press the Sleep Mode Auto button to set the time you want the unit to turn off automatically.



To cancel the Sleep Mode, press the sleep Mode Auto button until the star (★) disappears from the operation display.

1. The Timer is programmed in one-hour increments by pressing the Sleep Mode Auto button 1 to 7 times.

The sleep mode is available for 1 to 7 times.

To alter the time period in steps of 1 hour, press the Sleep Mode Button while aiming at air conditioner.

3. Make sure the Sleep Mode Auto LED lights up.



: The Sleep Mode will be operated at low fan speed (cooling) or medium fan speed (heat pump only) for quiet sleeping.

IN COOLING MODE: The temperature will automatically rise by 1 °C over the next 30 minutes and by 2 °C in 1 hour for comfortable sleeping.



Setting the Time

1. Time can be set only when you have pressed the Reset button. If you have just replaced the batteries, the Reset button should be pressed to reset the time.

Press the Start/Stop button.



2. Press 2nd F button and check if 2nd F icon is on.



3. Press the Time Setting buttons until the desired time is set.



4. Press the Timer SET button.



: Check the indicator for A.M. and P.M.



Delay Start/Pre-Set Stop

1. Make sure the time is set correctly on the Remote Controller display.

2. Press 2nd F button.



3. Press the ON/OFF Timer buttons to turn Timer on or off.



4. Press the Time Setting buttons until the desired time is set.



5. Press the selected on/off setting by pressing the Timer SET button while aiming the Remote Controller at the signal receptor.

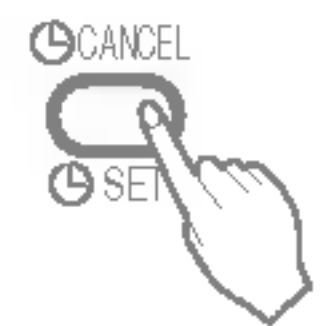

To cancel the setting the timer.



Press the Timer Cancel button while aiming Remote Controller at the signal receptor. (The timer lamp on the air conditioner and the display will go out.)



: Select one of the following four types of operation.

with the unit running



Delay OFF Timer



Delay ON Timer



Delay OFF and ON Timer



Delay ON and OFF Timer



Vertical Airflow Direction Control

The up/down airflow (Vertical Airflow) can be adjusted by using the Remote Controller.

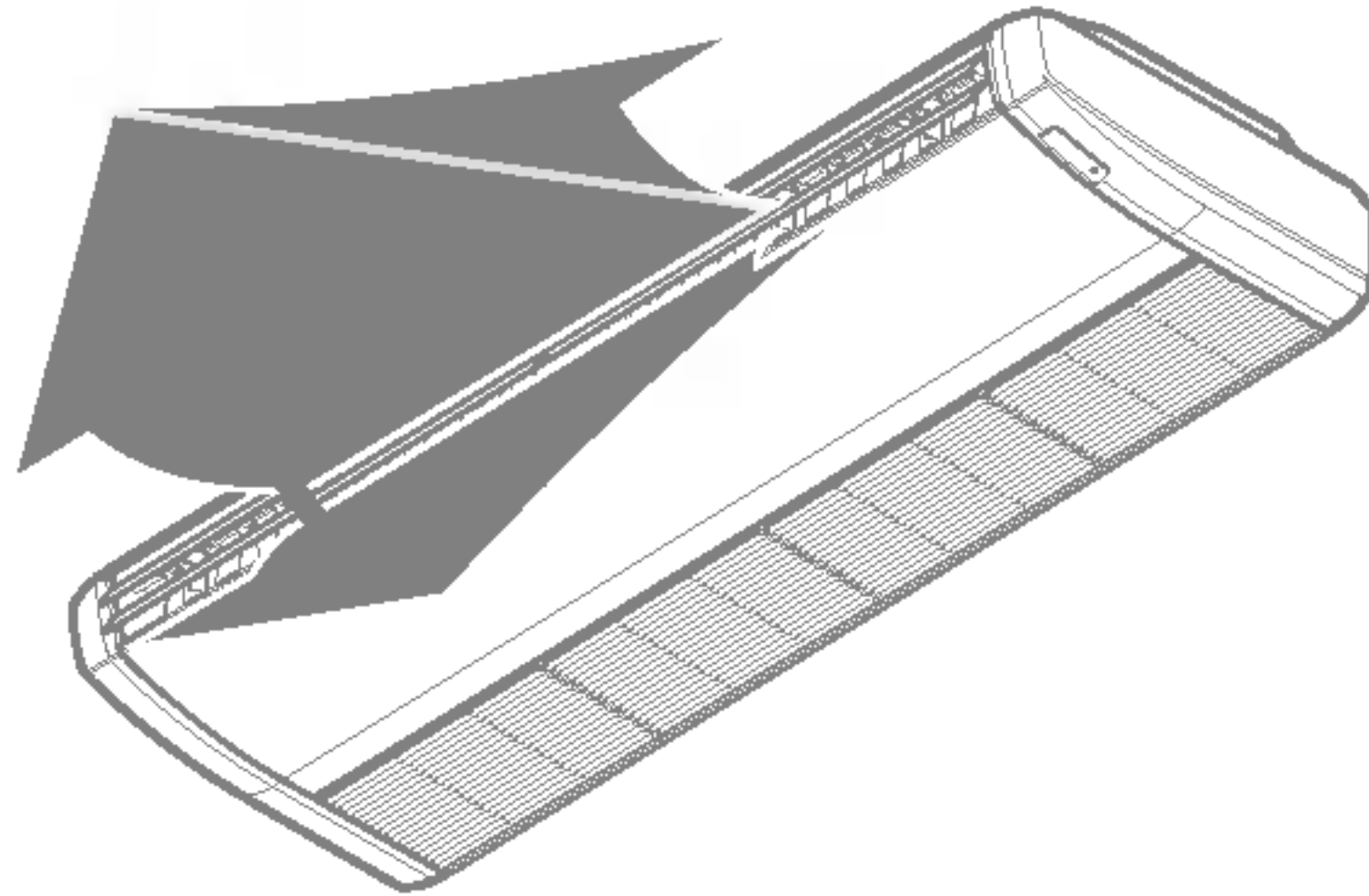

1. Press the Start/Stop button to start the unit.
2. Open the door on the Remote Controller.
3. Press Chaos Swing button and the louvers will swing up and down.
4. Press the Chaos Swing button again to set the vertical louver at the desired airflow direction.

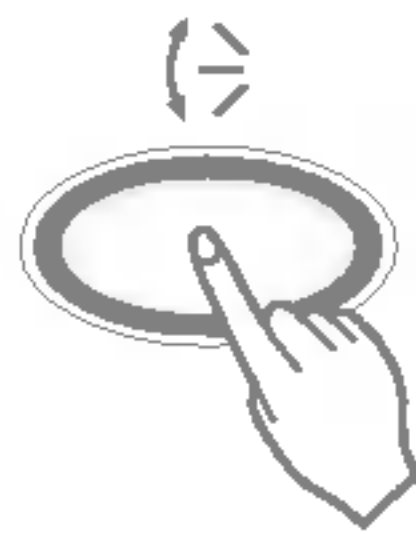

- ❑ If you press the CHAOS swing button, the horizontal airflow direction is changed automatically based on the CHAOS algorithm to distribute the air in the room evenly and at the same time to make the human body feel most comfortable, as if enjoying a natural breeze.
- ❑ Always use the remote control to adjust the up/down airflow direction. Manually moving the vertical airflow direction louver by hand could damage the air conditioner.
- ❑ When the unit is shut off, the up/down airflow direction louver will close the air outlet vent of the system.

To adjust left/right(Horizontal Airflow) direction

Caution : Ensure unit is turned off before adjusting the horizontal airflow direction control.

Carefully open vertical louver to allow access to the horizontal airflow direction.

Adjust the left/right airflow direction by hand.

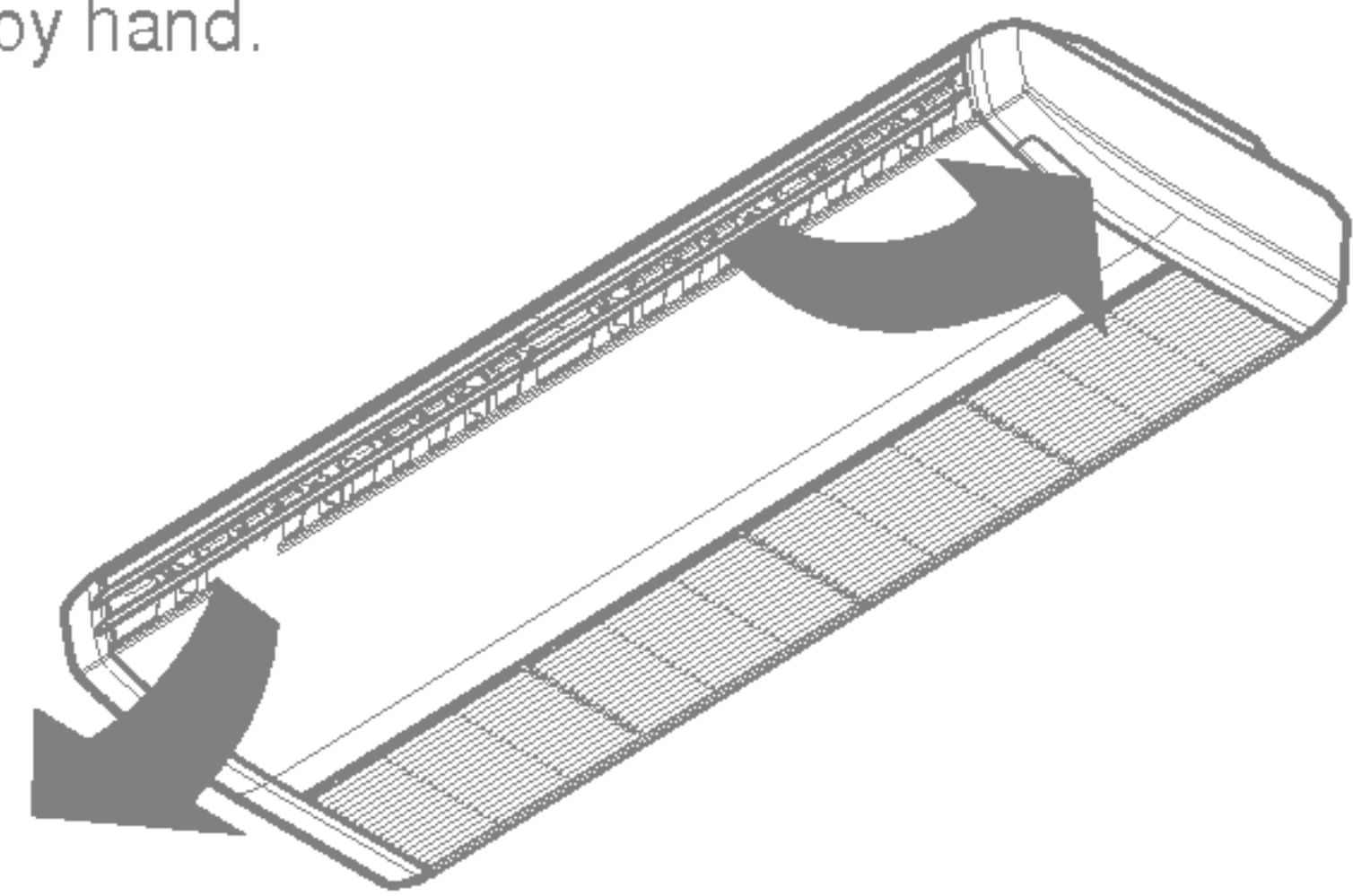

Air Circulation Mode

Circulates the room air without cooling or heating.

1. Press the Start/Stop button. The unit will respond with beep sound.
2. Open the door on the Remote Controller. Press the Air Circulation button. Now each time that you press the Indoor Fan Speed Selector, the fan speed is shifted from low to CHAOS and back to low again.

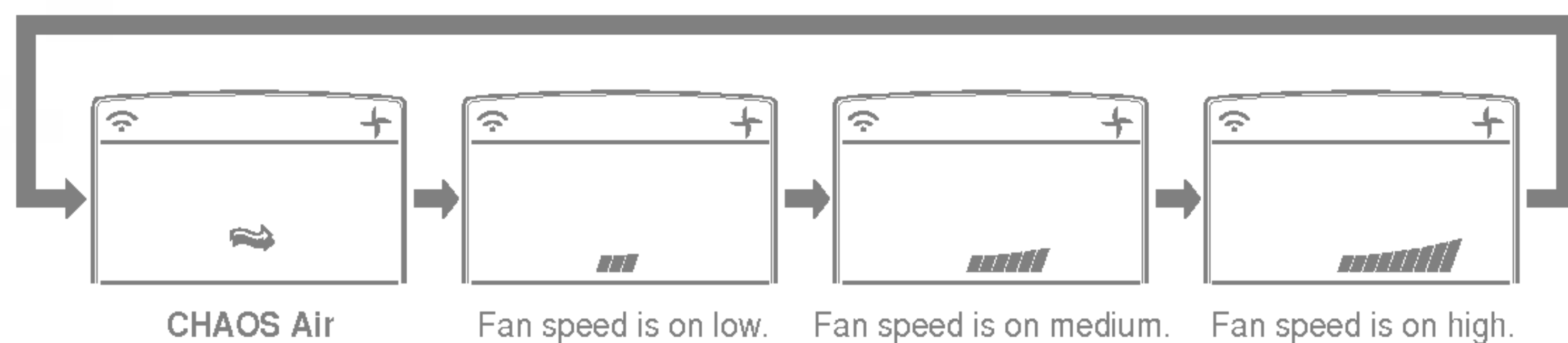
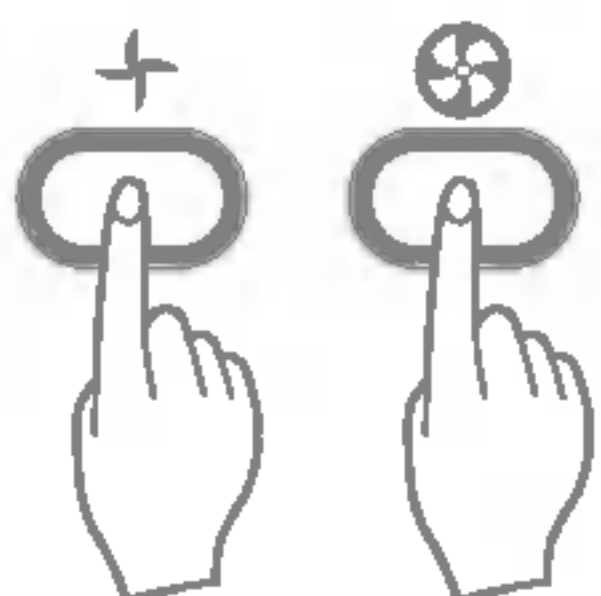

- ❑ **CHAOS Air** economizes power consumption and prevents overcooling. The fan speed is automatically changed from high to low or vice versa, depending on the ambient temperature.

Forced Operation

The operation will be started operation if the power button is pressed without remote controller.
If you want to stop operation, re-press the button.

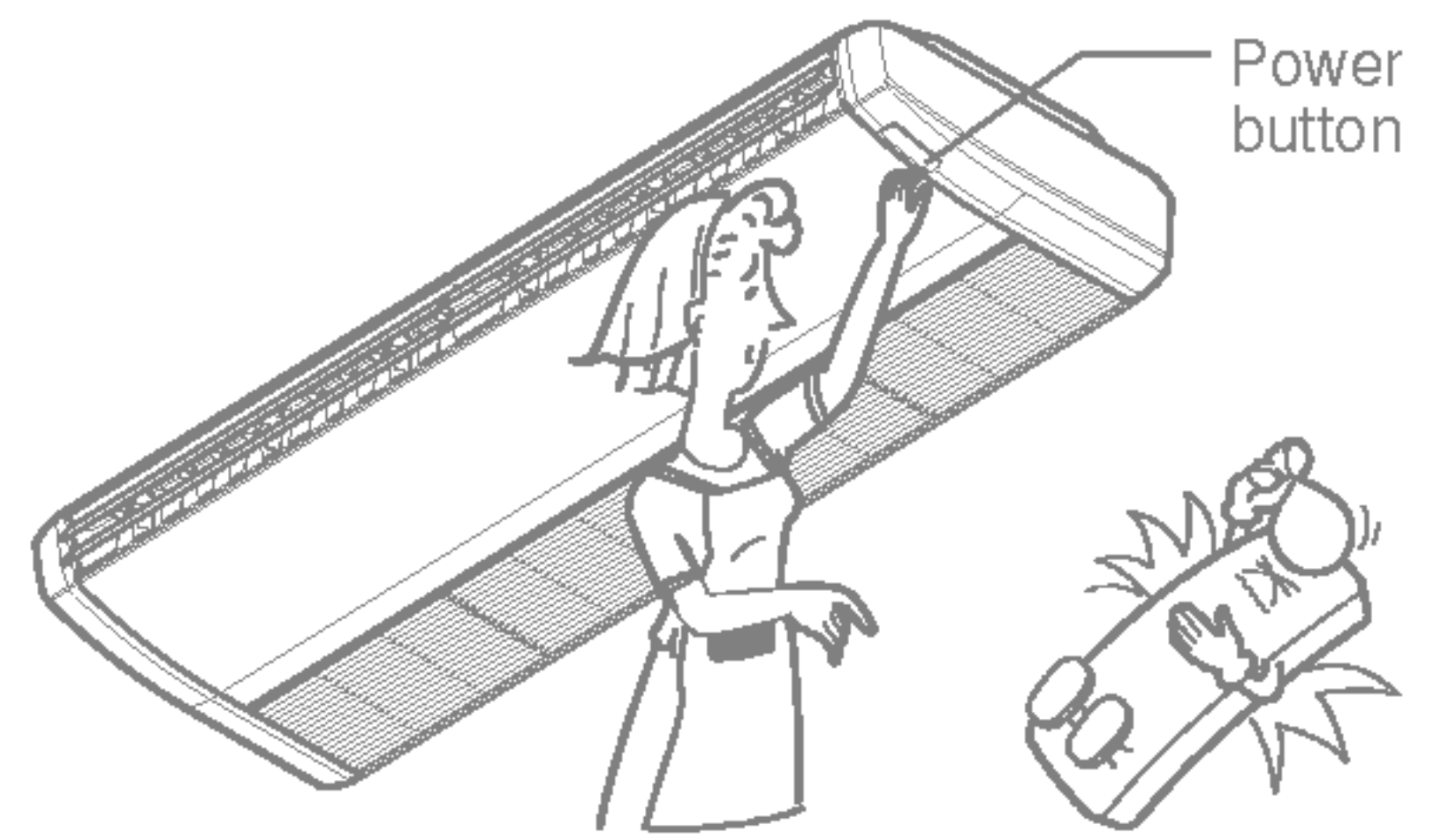

	Cooling Model	Heat pump Model		
		Room Temp. $\geq 24^{\circ}\text{C}$	$21^{\circ}\text{C} \leq \text{Room Temp.} < 24^{\circ}\text{C}$	Room Temp. $< 21^{\circ}\text{C}$
Operating mode	Cooling	Cooling	Healthy Dehumidification	Heating
Indoor FAN Speed	High	High	High	High
Setting Temperature	22°C	22°C	Air Intake Temperature	24°C

Auto restart

In case the power comes on again after a power failure, the unit operates automatically to the previous operating conditions.

So there is no need of activating this function by pressing any key or button.

In the initial mode, the fan operates at a low speed and the compressor starts about 3 minutes later.

As the compressor starts, the fan speed also resumes its previous setting mode.

WARNING

: In case of absence for a long time while power failure, turn off main power to avoid undesired Auto restart.

Helpful information

Fan speed and cooling capacity.

The cooling capacity indicated in the specification is the value when the fan speed is set to high, and the capacity will be lower at low or medium fan speed.

High fan speed is recommended when you wish to cool the room quickly.

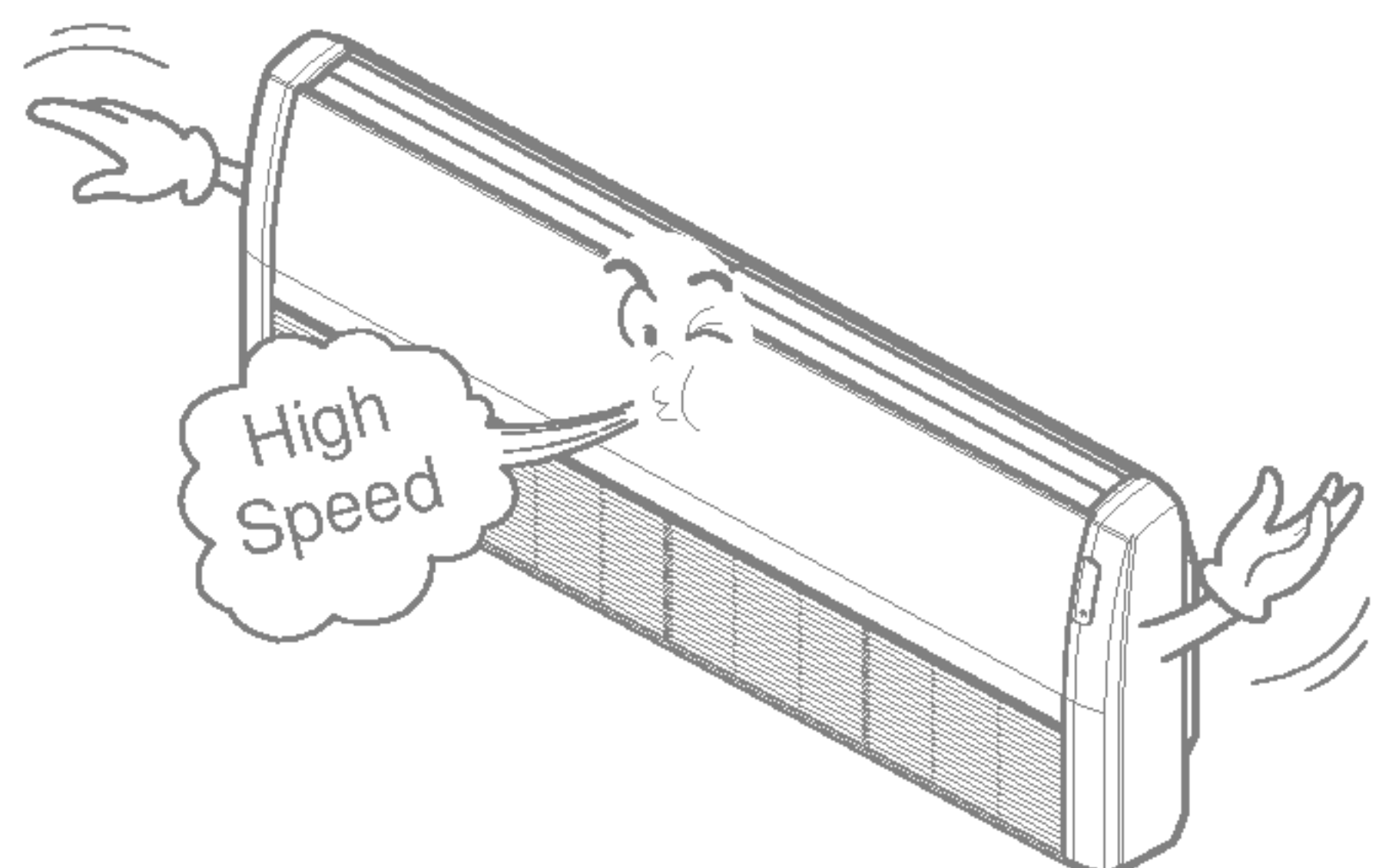

Before performing any maintenance, turn off the main power to the system.

Grille, Case, and Remote Control

- Turn the system off before cleaning.
To clean, wipe with a soft, dry cloth. Do not use bleach or abrasives.

Caution: Supply power must be disconnected before cleaning the indoor unit.

- Never use any of the followings:
 - Water hotter than 40°C. could cause deformation and/or discoloration.
 - Volatile substances could damage the surfaces of the air conditioner.



AIR FILTERS

The air filters behind the inlet grille should be checked and cleaned once in every 2 weeks or more often if necessary.

1. Pull the filter hook to take the filter out.
2. Clean the filter with a vacuum cleaner or warm, soapy water.
 - If dirt is conspicuous, wash with a solution of detergent in lukewarm water.
 - If hot water (40°C or more) is used, it may be deformed.
3. After washing with water, dry well in the shade.
4. Re-install the air filter by pushing the filter inside the inlet grill.

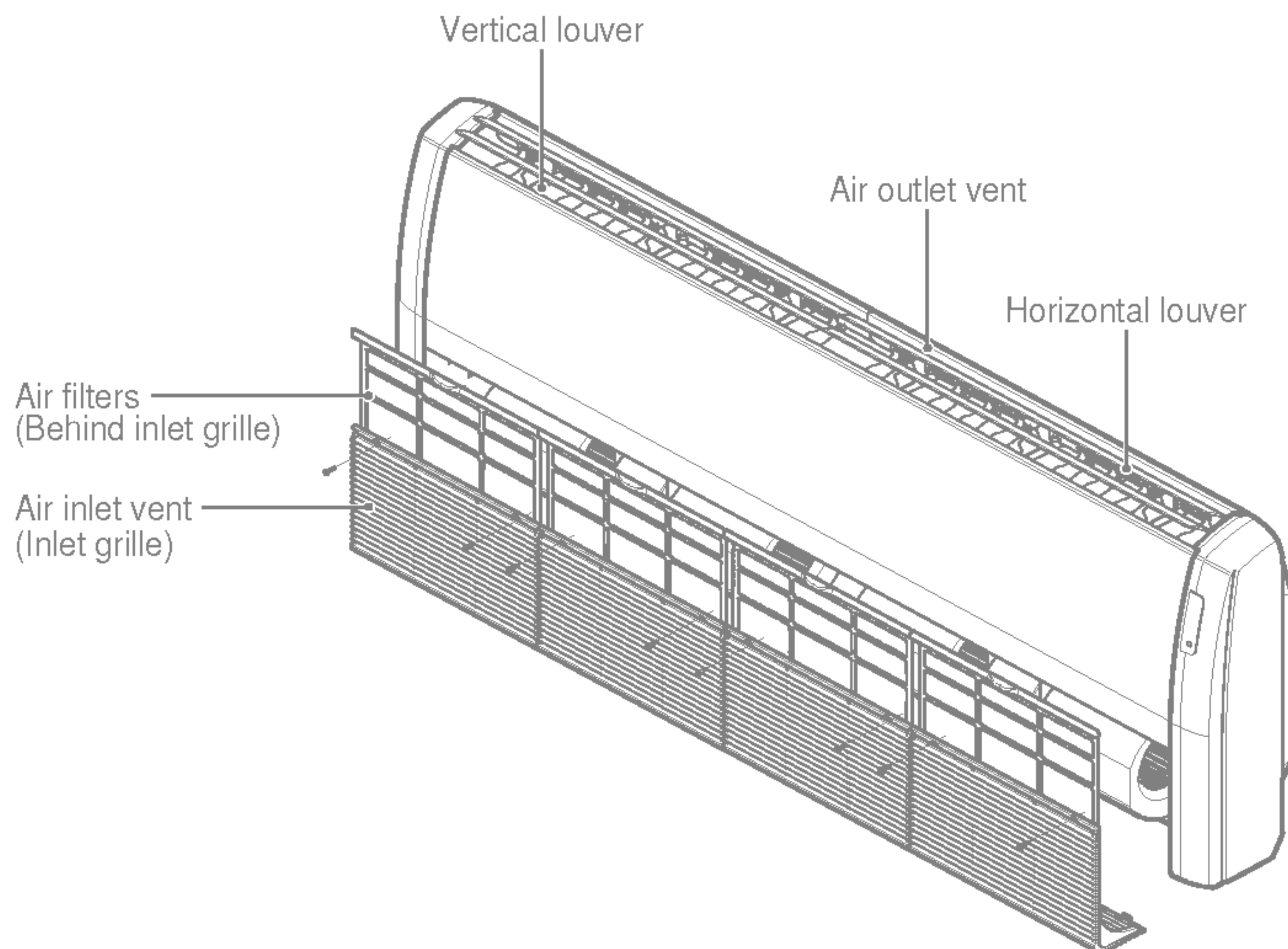

When air conditioner is not going to be used for a long time.

- Operate the air conditioner on Air circulation mode (Refer to page 19) for 2 to 3 hours.
 - This will dry out the internal mechanisms.
- Turn off the circuit breaker, and disconnect the power cable.

⚠ WARNING

: Turn off the circuit breaker when the air conditioner is not going to be used for a long time.

Dirt may collect and may cause a fire.

- Remove the batteries from the Remote Controller.

When the air conditioner is to be used again.

- Clean the air filter and install it in the indoor unit. (Refer to page 21 for cleaning filters.)
- Check that the air inlet and outlet of the indoor/outdoor unit are not blocked.

Do not overcool the room.

This is not good for the health and wastes electricity.

Make sure that the doors and windows are shut tight.

Avoid opening doors and windows if possible to keep the cool air in the room.

Keep blinds or curtains closed.

Do not let direct sunshine enter the room when the air conditioner is in operation.

Clean the air filter regularly.

Blockages in the air filter reduce the airflow and lower cooling and dehumidifying effects. Clean at least once every two weeks.

Keep the room temperature uniform.

Adjust the vertical and horizontal airflow direction to ensure a uniform temperature in the room.

Ventilate the room occasionally.

Since windows are kept closed, it is a good idea to open them and ventilate the room now and then.

Check the following points before requesting repairs or service.... If the fault persists, please contact your dealer or service center.

Case	Explanation	See page
The air conditioner does not operate.	• Check room temperature setting?	-
	• Check if circuit breaker is on?	-
The room has a peculiar odor.	• Check that this is not a damp smell exuded by the walls, carpet, furniture, or cloth items in the room.	-
It seems that condensation is leaking from the air conditioner.	• Check the drain hose is connected tight or if indoor unit is installed even.	-
Air conditioner does not operate for about 3 minutes after turning on.	<ul style="list-style-type: none"> • This is the protector of the mechanism. • Wait about 3 minutes and operation will begin. • About 3 minutes delay is applied to protect compressor from frequently on/off. 	-
Does not cool or heat effectively.	• Is the air filter dirty? See air filter cleaning instructions.	21
	• Has the temperature been set correctly?	11, 14
	• Are the indoor unit's air inlet or outlet vents obstructed?	-
The air conditioner operation is noisy.	<ul style="list-style-type: none"> • For a noise that sounds like water flowing. -This is the sound of refrigerant flowing inside the air conditioner unit. • For a noise that sounds like the compressed air releasing into atmosphere. -This is the sound of the dehumidifying water being processed inside the air conditioning unit. 	-
Remote Controller display is faint, or no display at all.	<ul style="list-style-type: none"> • Are the batteries depleted? • Are the batteries inserted in the opposite (+) and (-) directions? 	-
Crack sound is heard.	• This sound is generated by the expansion/contraction of the front panel, etc. due to changes of temperature.	-

Details of LG serial No.

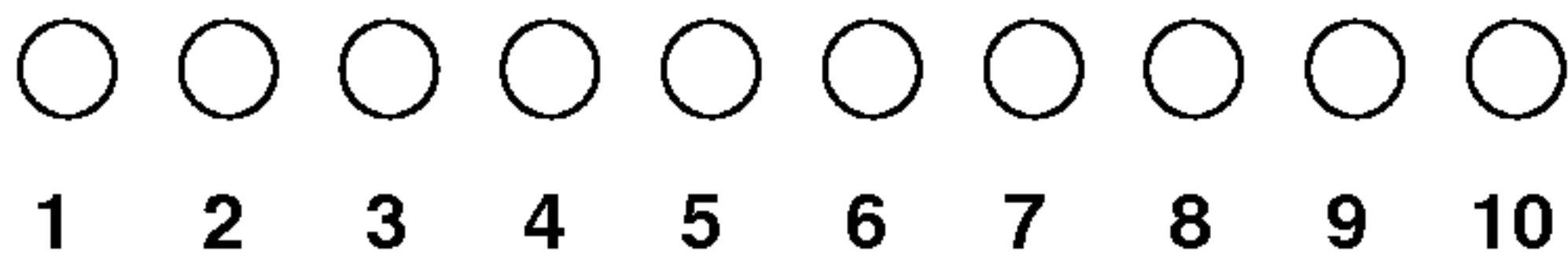

Main Service Part List

Code	Detail	Code of Model	Meaning
1	Year	0~9 (Digit)	The last digit of year ex) 1997 →7, 2000 →0
2,3	Month	01~12 (Digit)	Month ex) March →03, August →08
4	Nation	A~Z (Alphabet)	Where manufactured ex) K →Korea, C →China
5	Product	A~Z (Alphabet)	ex) A →Airconditioner
6~10	Serial No.	0~9 (Digit)	Production Quantity

NO	PART NAME
1	COMPRESSOR
2	MOTOR
3	MAIN PCB ASSY
4	REMOCON
5	TRANSFORMER

H. G. IBRAHIM SHAKER COMPANY, LTD.

SERVICE CENTER

- * JEDDAH → P. O. BOX 50, JEDDAH 21411 KINGDOM OF SAUDI ARABIA
TEL NO. : 6422952 / 6425527
- * RIYADH → P. O. BOX 15, RIYADH 11411 KINGDOM OF SAUDI ARABIA
TEL NO. : 4020570
- * AL-KHOBAR → P. O. BOX 78, AL-KHOBAR 31952 KINGDOM OF SAUDI ARABIA
TEL NO. : 8943714