



website <http://www.lgservice.com>
e-mail http://www.lgservice.com/faq/faq_setup.html

MULTI V™ System Heat Pump Indoor Unit ***OWNER'S MANUAL***

MODELS: LRNN, LRNV-BE/BG/BH Series
Type: Ceiling Concealed Duct- High Static

Prior to installation, this air-conditioning unit must be submitted for approval by the utility service which provides electricity (EN 61000-2, EN 61000-3 Norm).

- Please read this owner's manual carefully and thoroughly before installing and operating your room air conditioner.
- Please retain this owner's manual for future reference after reading it thoroughly.



FOR YOUR RECORDS

Write the model and serial numbers here:

Model # _____

Serial # _____

You can find them on a label on the side of each unit.

Dealer's Name _____

Date Purchased _____

- Staple your receipt to this page in the event you need it to prove date of purchase or for warranty issues.



READ THIS MANUAL

Inside you will find many helpful hints on how to use and maintain your air conditioner properly. Just a little preventive care on your part can save you a great deal of time and money over the life of your air conditioner.

You'll find many answers to common problems in the chart of troubleshooting tips. If you review our chart of

Troubleshooting Tips first, you may not need to call for service at all.



PRECAUTION

- Contact the authorized service technician for repair or maintenance of this unit.
- Contact the installer for installation of this unit.
- The air conditioner is not intended for use by young children or invalids without supervision.
- Young children should be supervised to ensure that they do not play with the air conditioner.
- When the power cord is to be replaced, replacement work shall be performed by authorized personnel only using only genuine replacement parts.
- Installation work must be performed in accordance with the National Electric Code by qualified and authorized personnel only.

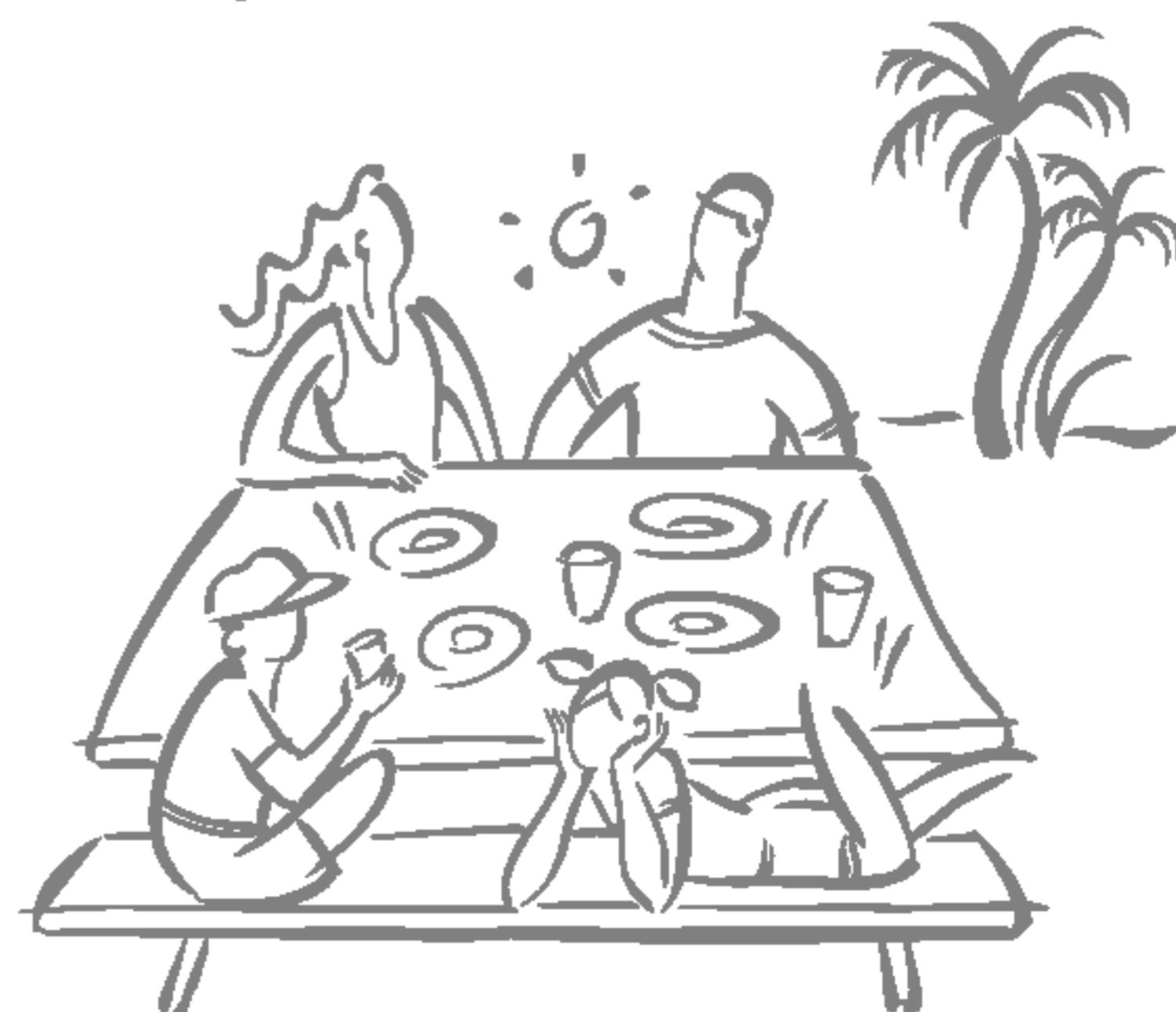



To prevent injury to the user or other people and property damage, the following instructions must be followed.

■ Incorrect operation due to ignoring instruction will cause harm or damage. The seriousness is classified by the following indications.

⚠ WARNING This symbol indicates the possibility of death or serious injury.

⚠ CAUTION This symbol indicates the possibility of injury or damage to properties only.

■ Meanings of symbols used in this manual are as shown below.

	Be sure not to do.
	Be sure to follow the instruction.

⚠ WARNING

■ Installation

Do not use a defective or underrated circuit breaker. Use this appliance on a dedicated circuit.

- There is risk of fire or electric shock.

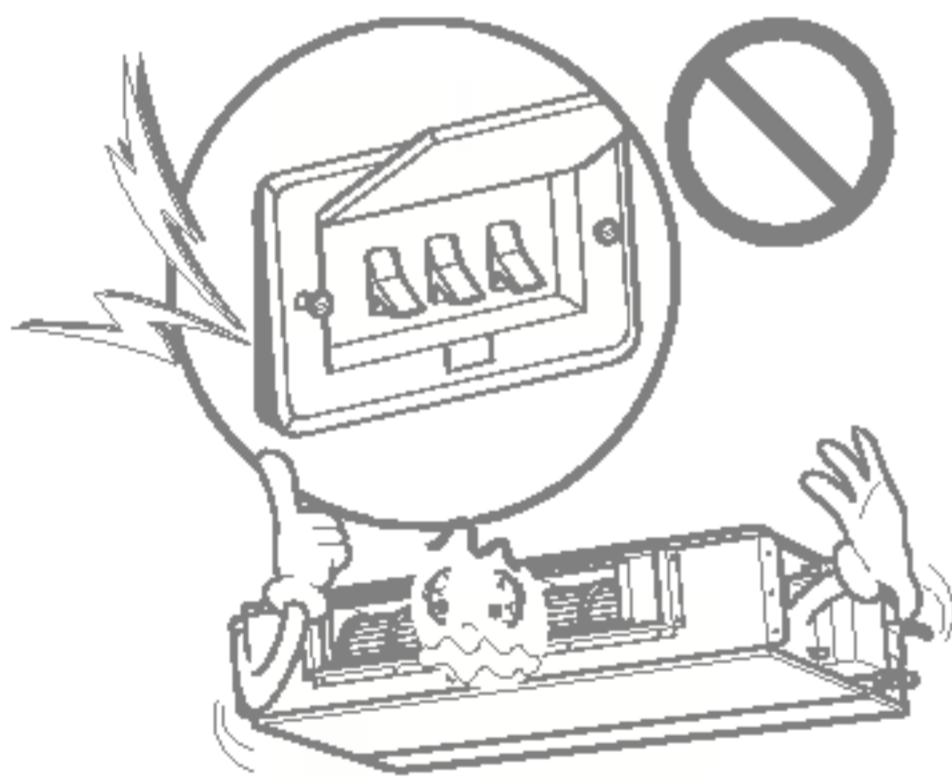

For electrical work, contact the dealer, seller, a qualified electrician, or an Authorized Service Center.

- Do not disassemble or repair the product. There is risk of fire or electric shock.

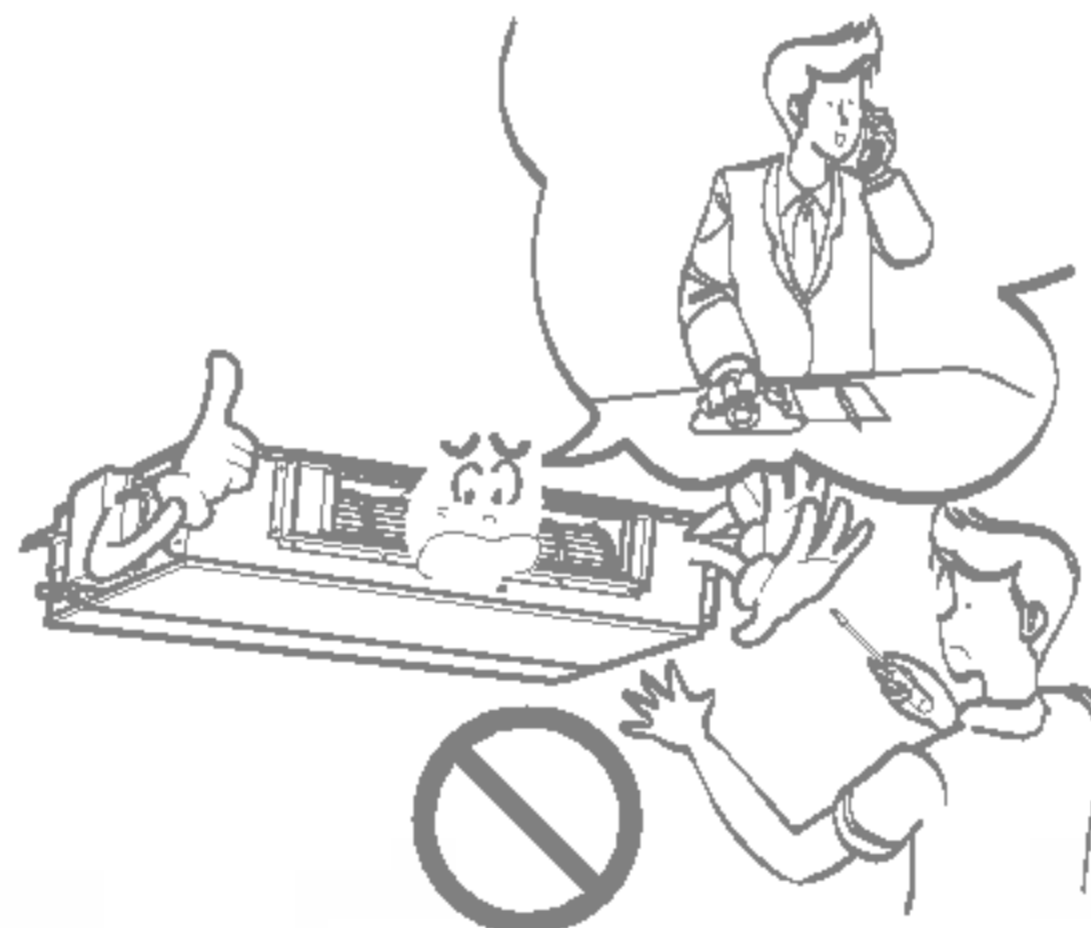

- There is risk of fire or electric shock.

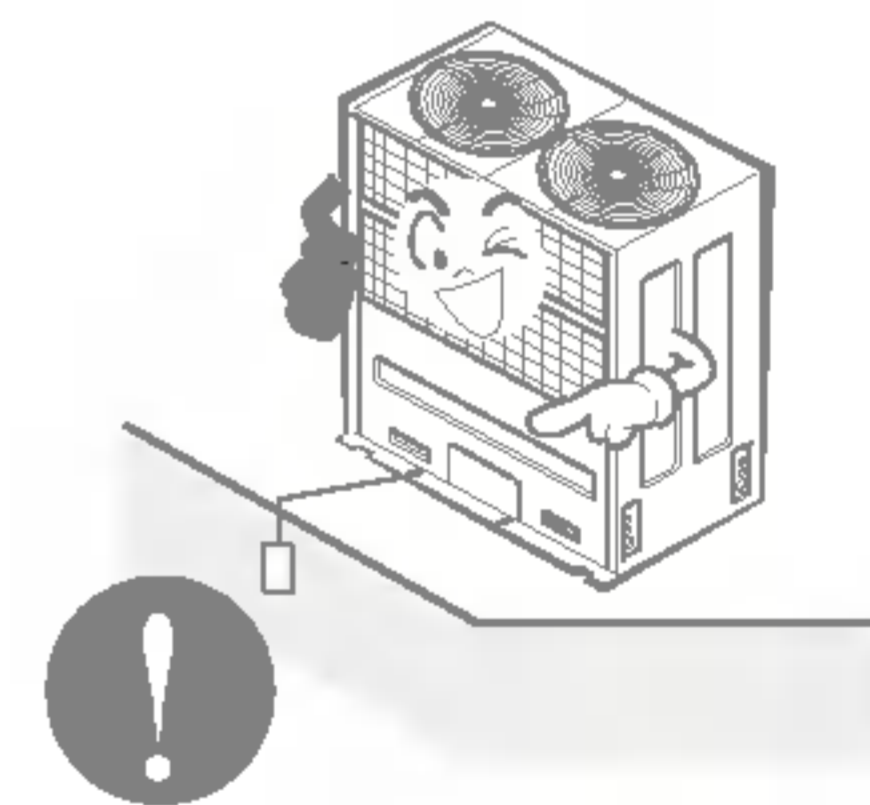

Install the panel and the cover of control box securely.

- There is risk of fire or electric shock.

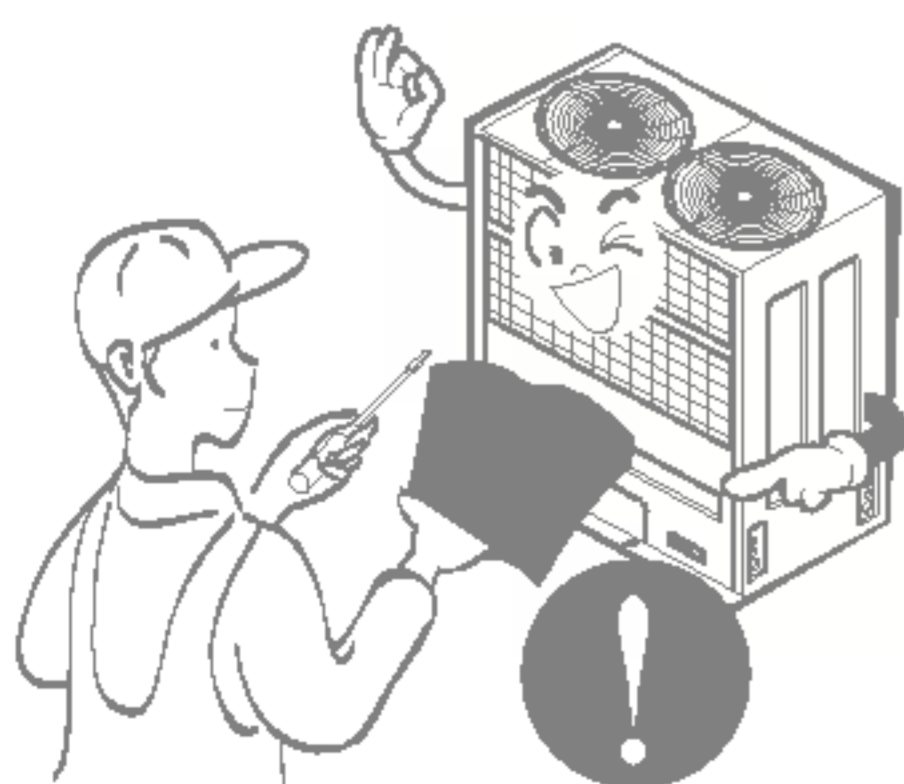

Always install a dedicated circuit and breaker.

- Improper wiring or installation may cause fire or electric shock

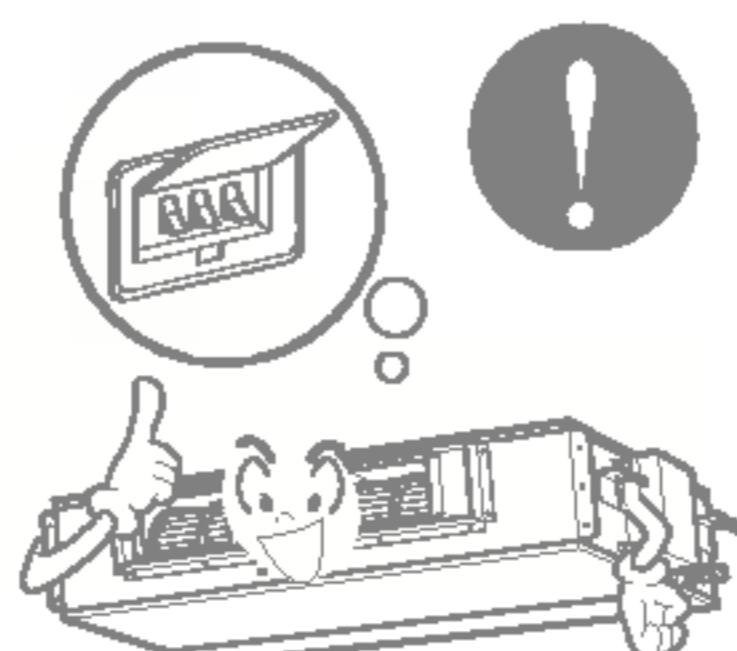

Use the correctly rated breaker or fuse.

- There is risk of fire or electric shock.



Do not modify or extend the power cable.

- There is risk of fire or electric shock.

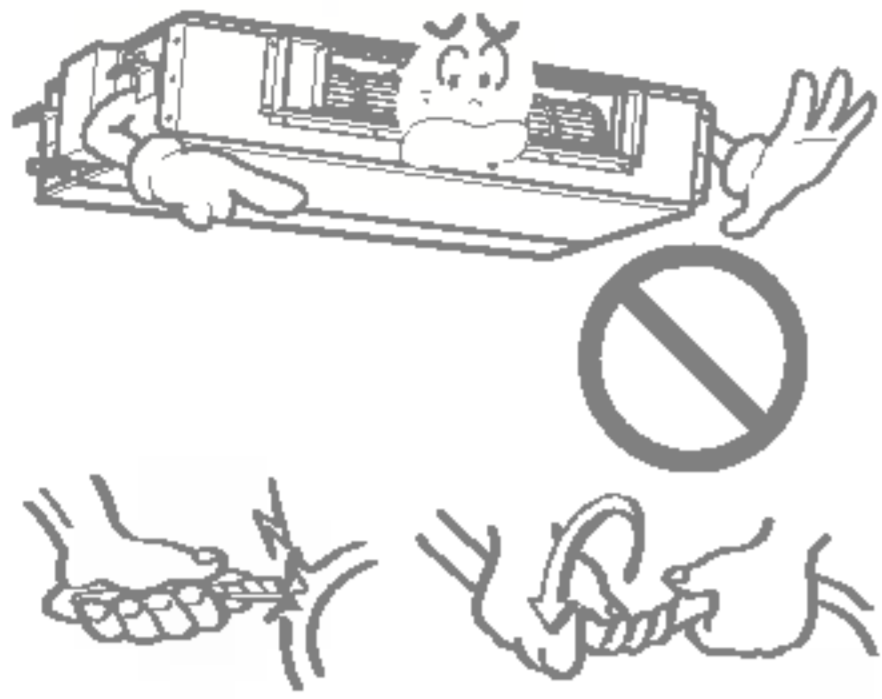

Do not install, remove, or re-install the unit by yourself (customer).

- There is risk of fire, electric shock, explosion, or injury.

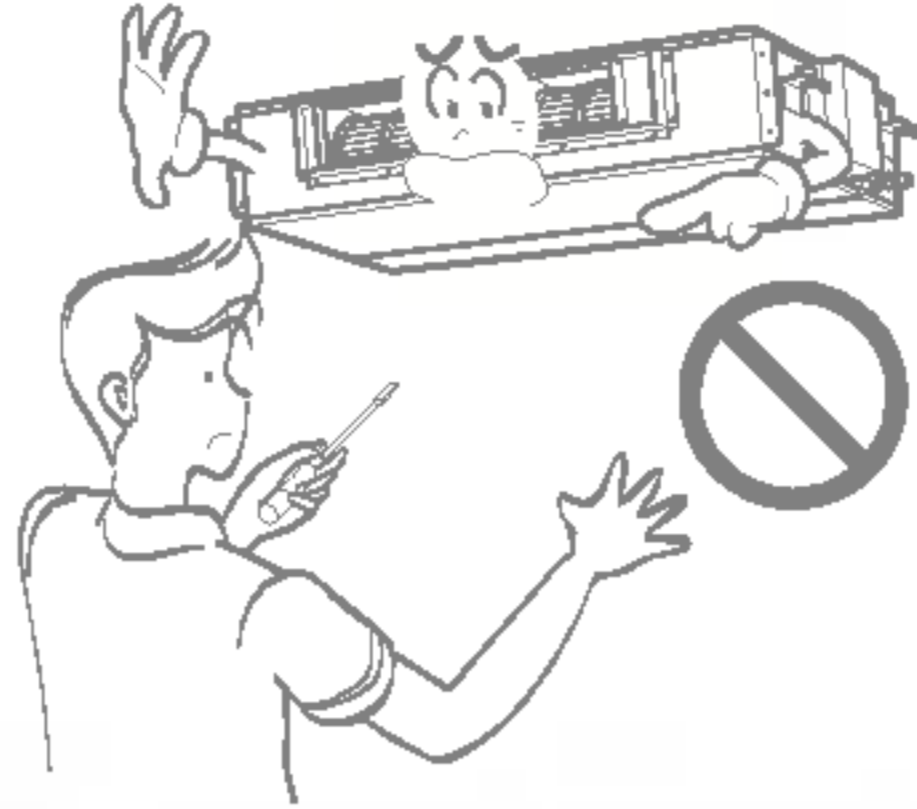

Be cautious when unpacking and installing the product.

- Sharp edges could cause injury. Be especially careful of the case edges and the fins on the condenser and evaporator.



For installation, always contact the dealer or an Authorized Service Center.

- There is risk of fire, electric shock, explosion, or injury.

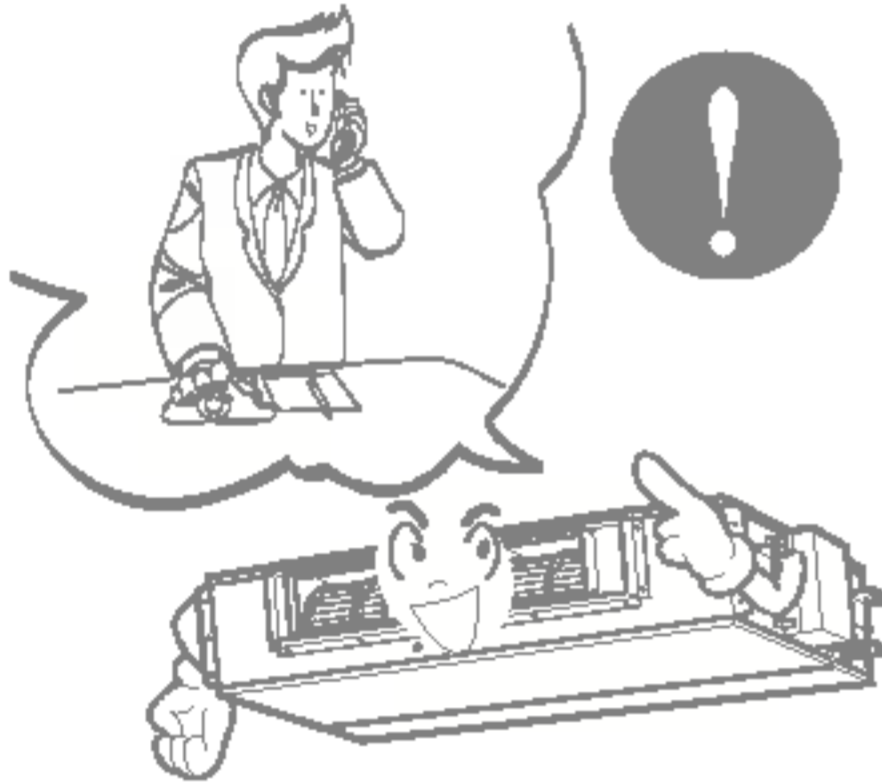

Do not install the product on a defective installation stand.

- It may cause injury, accident, or damage to the product.

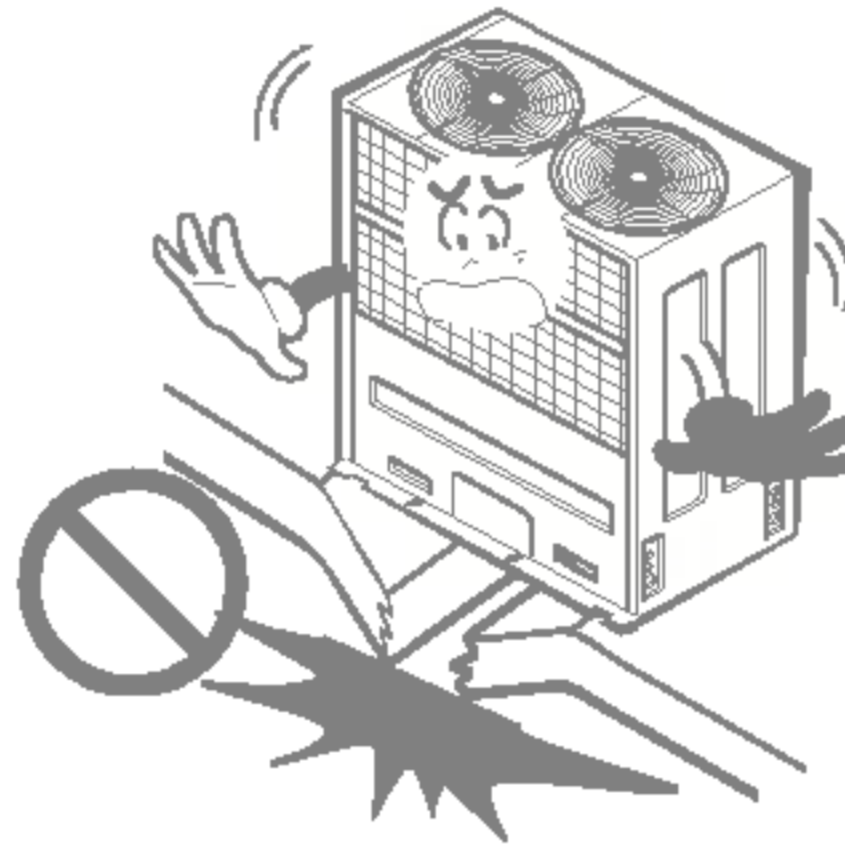

Be sure the installation area does not deteriorate with age.

- If the base collapses, the air conditioner could fall with it, causing property damage, product failure, and personal injury.

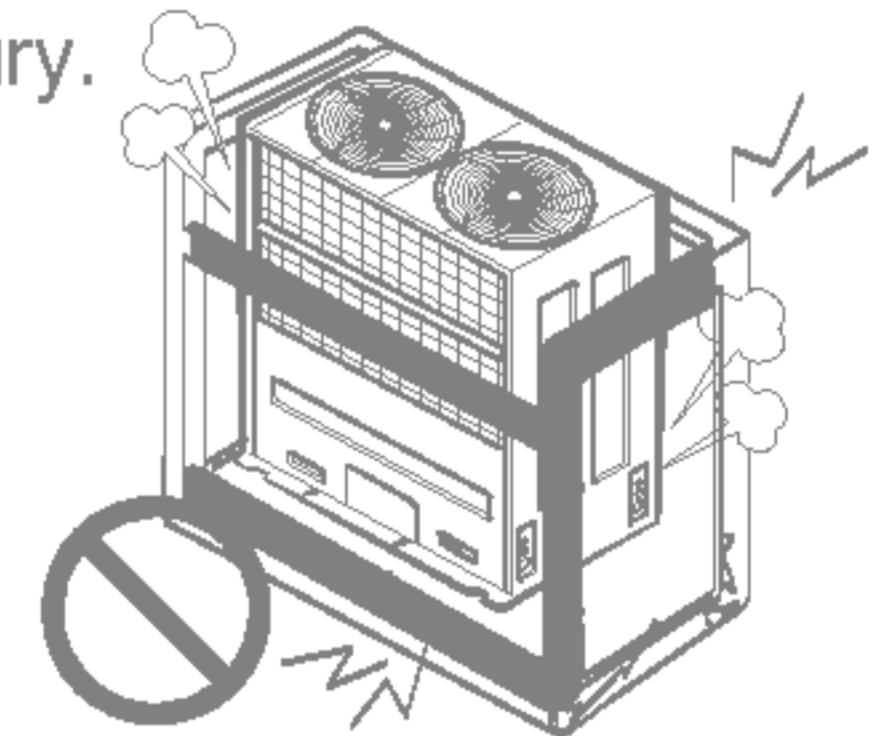

■ Operation

Do not let the air conditioner run for a long time when the humidity is very high and a door or a window is left open.

- Moisture may condense and wet or damage furniture.



Take care to ensure that power cable could not be pulled out or damaged during operation.

- There is risk of fire or electric shock.



Do not place anything on the power cable.

- There is risk of fire or electric shock.

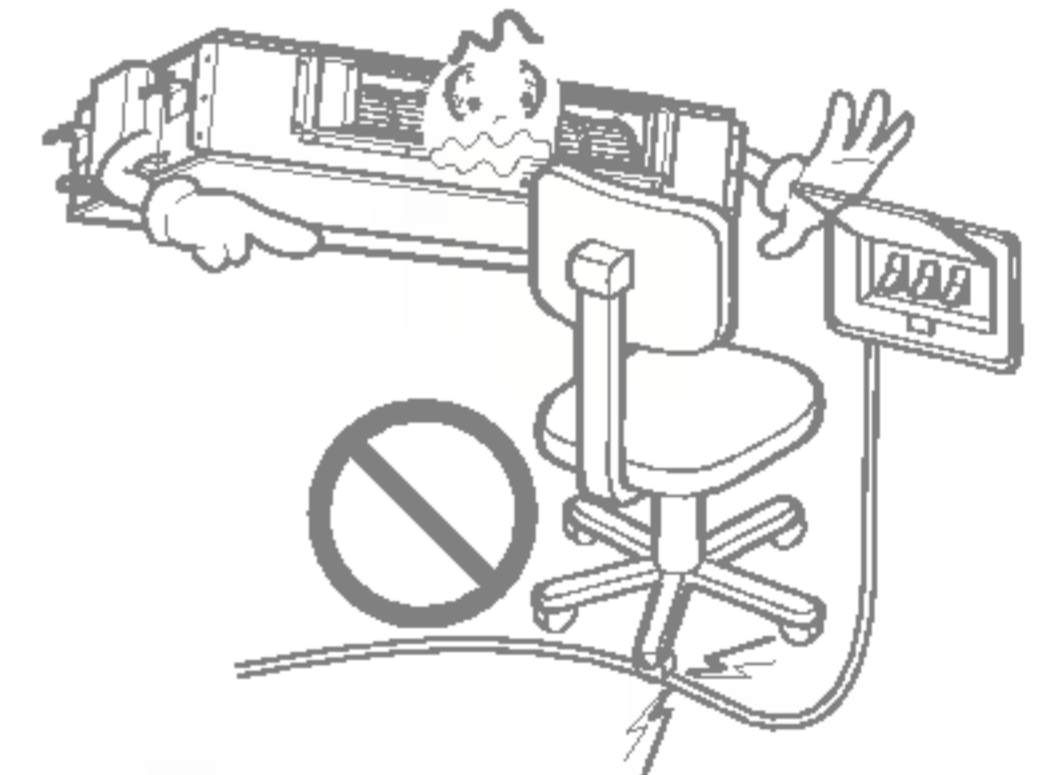

Do not plug or unplug the power supply plug during operation.

- There is risk of fire or electric shock.

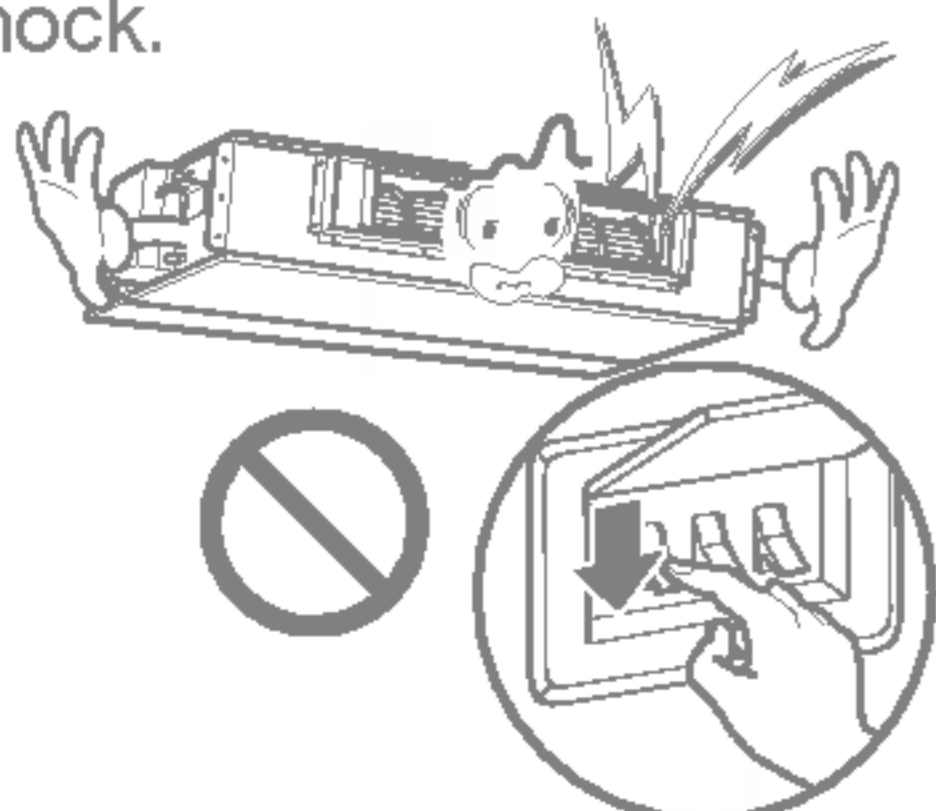

Do not touch (operate) the product with wet hands.

- There is risk of fire or electrical shock.

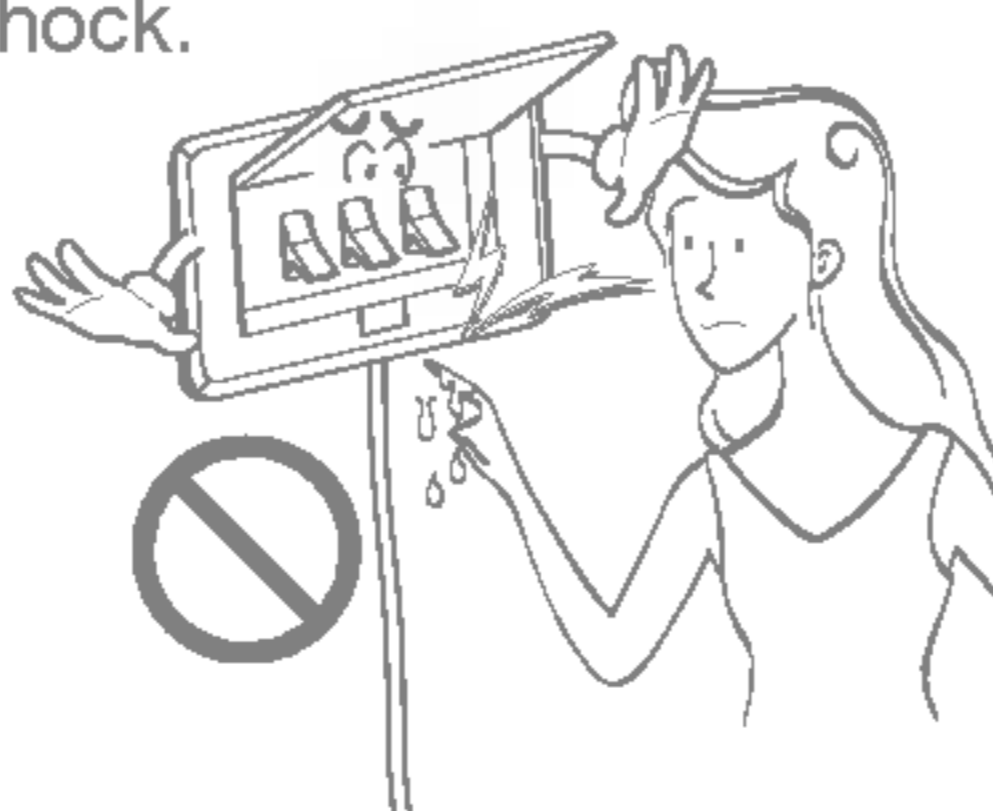

Do not place a heater or other appliances near the power cable.

- There is risk of fire and electric shock.

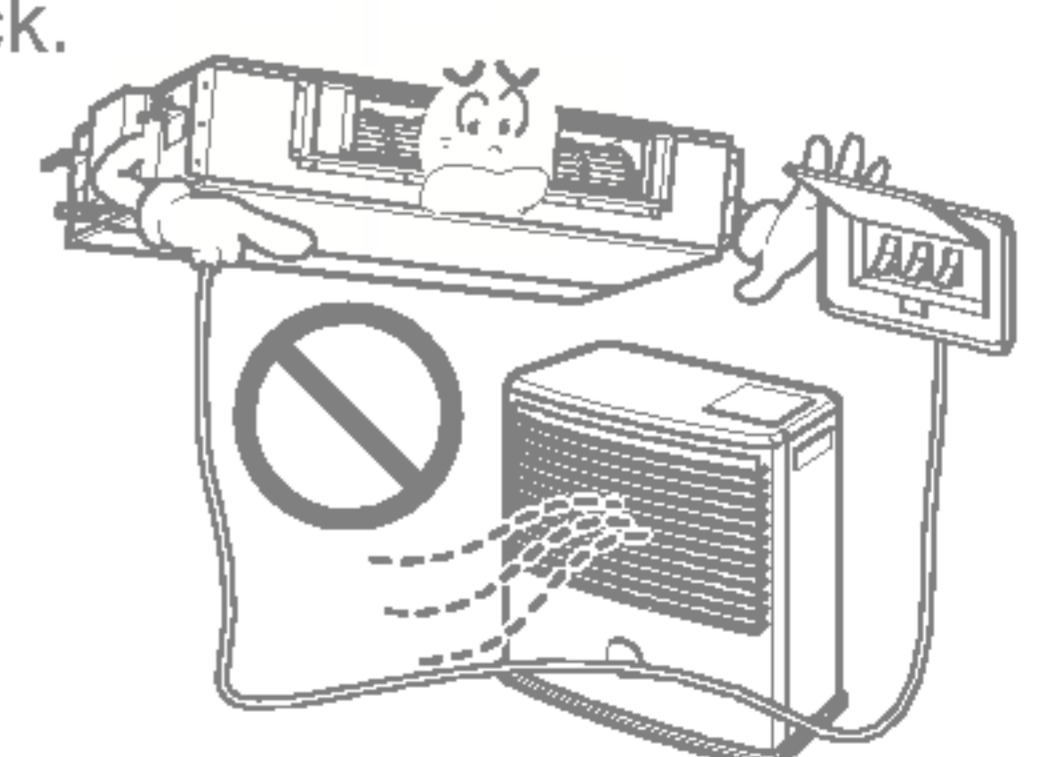

Do not allow water to run into electric parts.

- It may cause There is risk of fire, failure of the product, or electric shock.

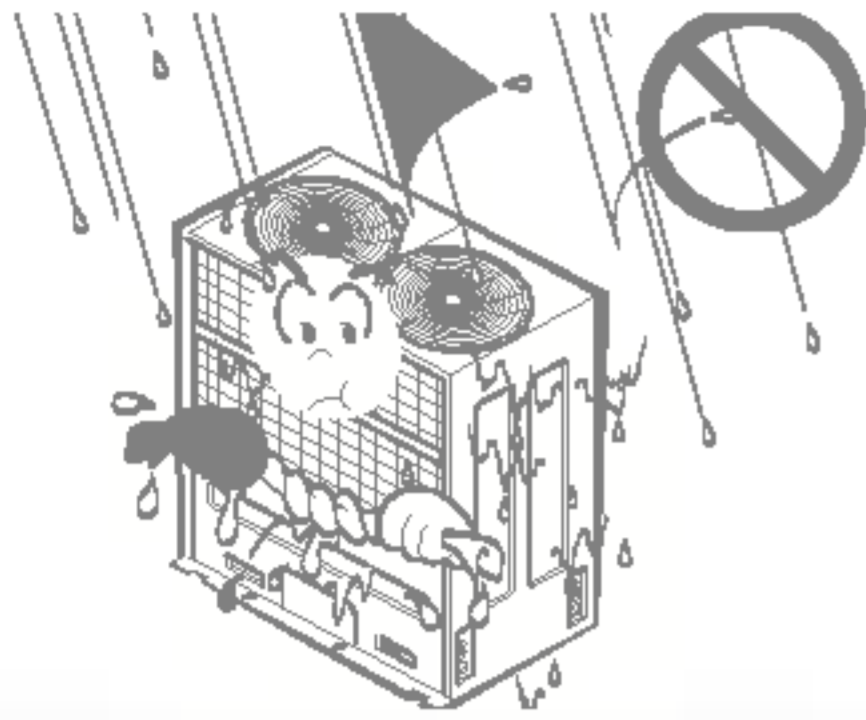

Do not store or use flammable gas or combustibles near the product.

- There is risk of fire or failure of product.

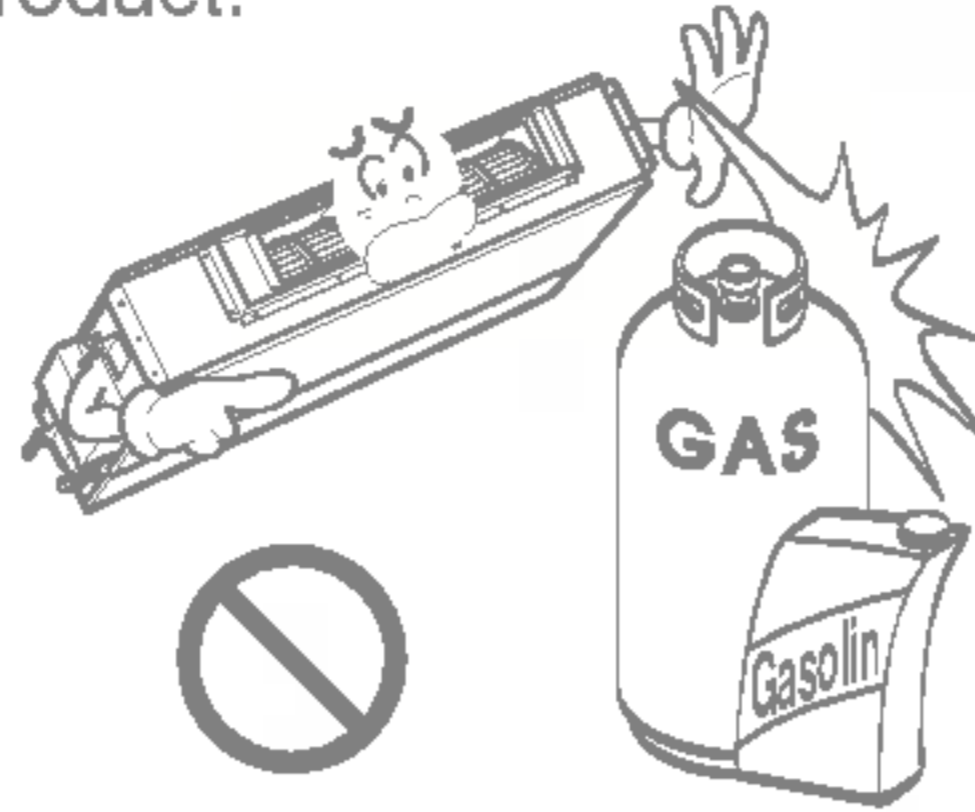

Do not use the product in a tightly closed space for a long time.

- Oxygen deficiency could occur.

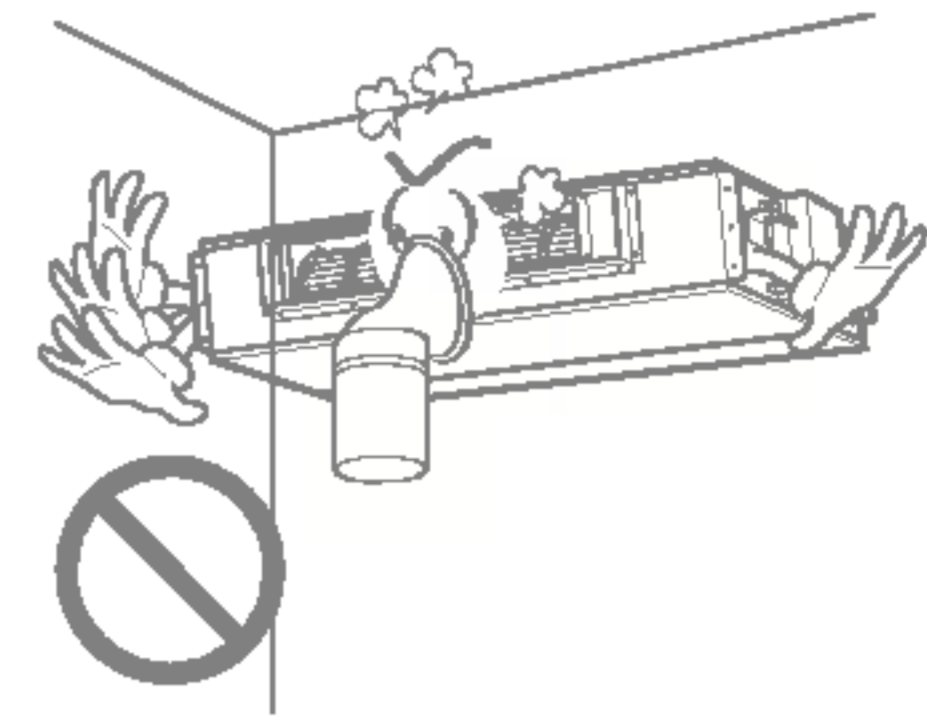

When flammable gas leaks, turn off the gas and open a window for ventilation before turn the product on.

- Do not use the telephone or turn switches on or off. There is risk of explosion or fire

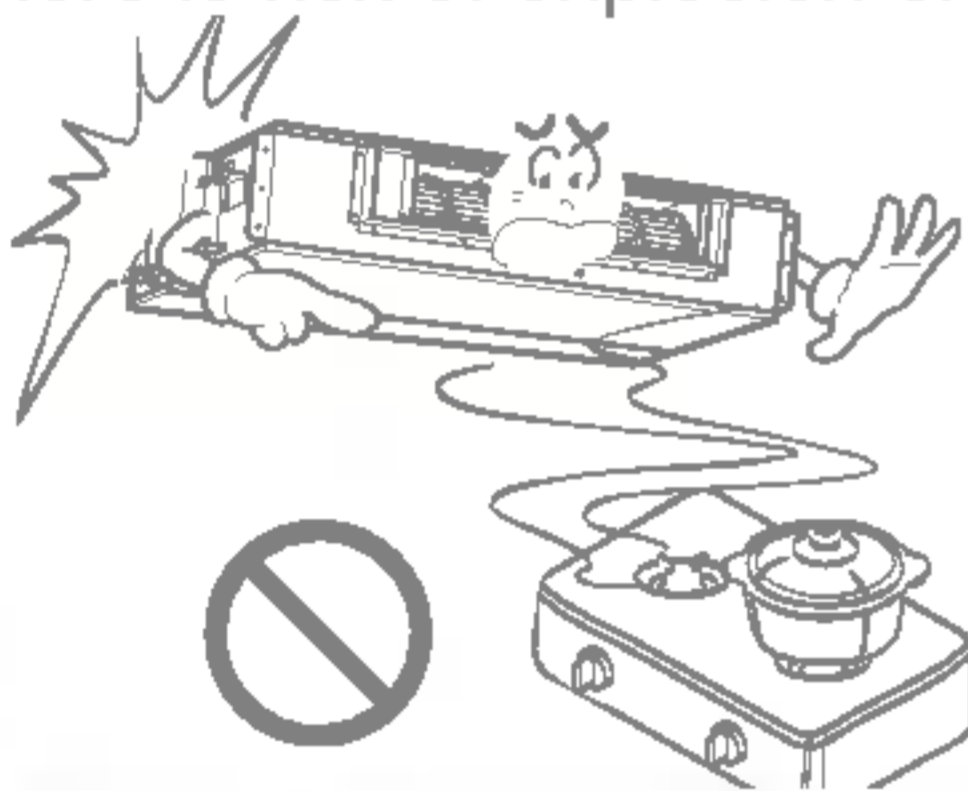

If strange sounds, or small or smoke comes from product. Turn the breaker off or disconnect the power supply cable.

- There is risk of electric shock or fire.



Stop operation and close the window in storm or hurricane. If possible, remove the product from the window before the hurricane arrives.

- There is risk of property damage, failure of product, or electric shock.

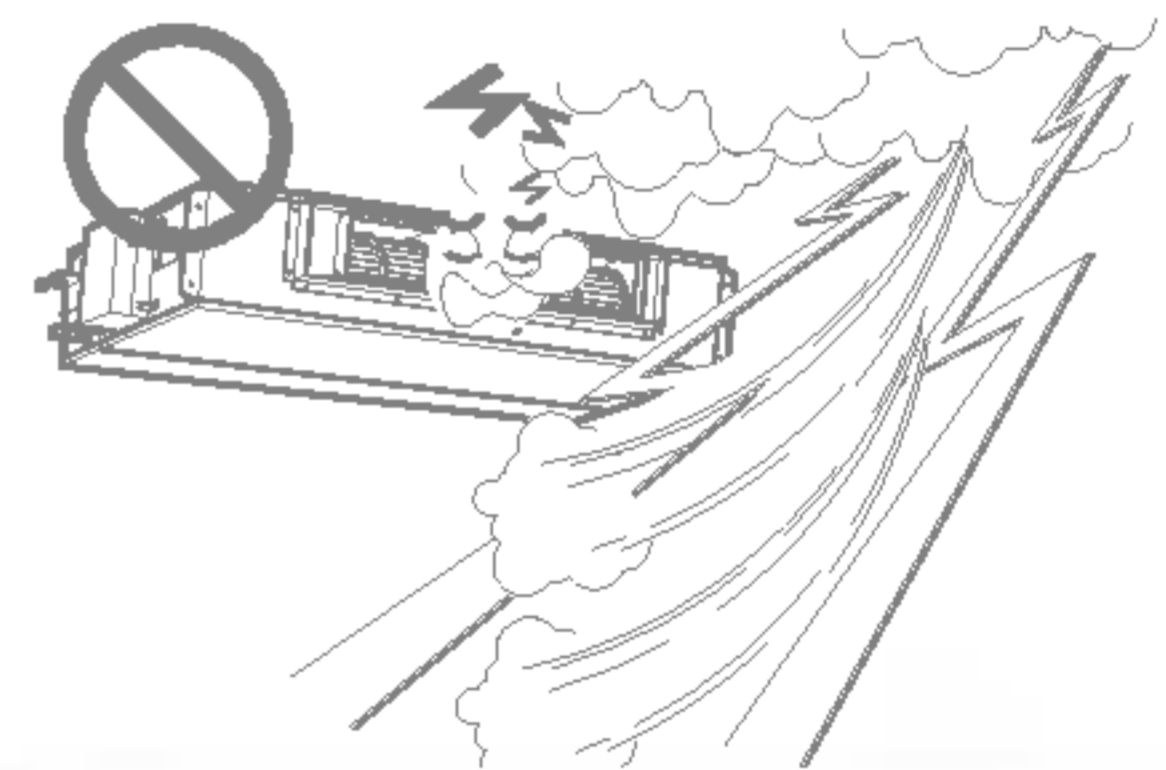

Do not open the inlet grill of the product during operation. (Do not touch the electrostatic filter, if the unit is so equipped.)

- There is risk of physical injury, electric shock, or product failure.

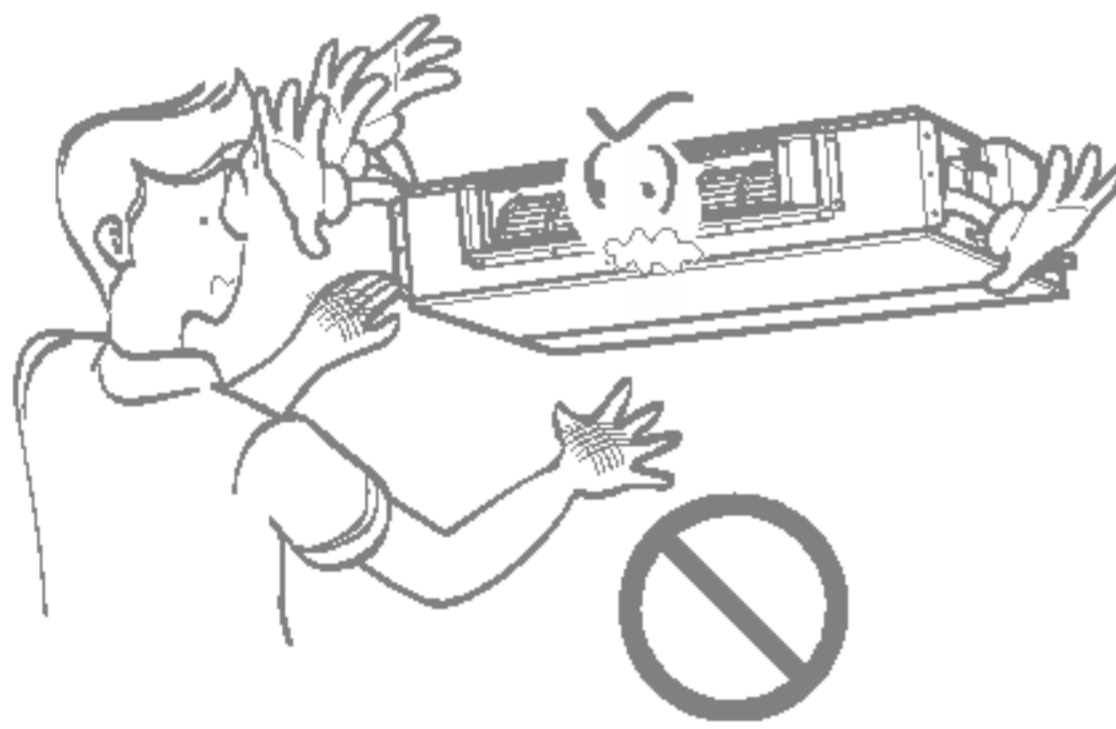

When the product is soaked (flooded or submerged), contact an Authorized Service Center.

- There is risk of fire or electric shock.

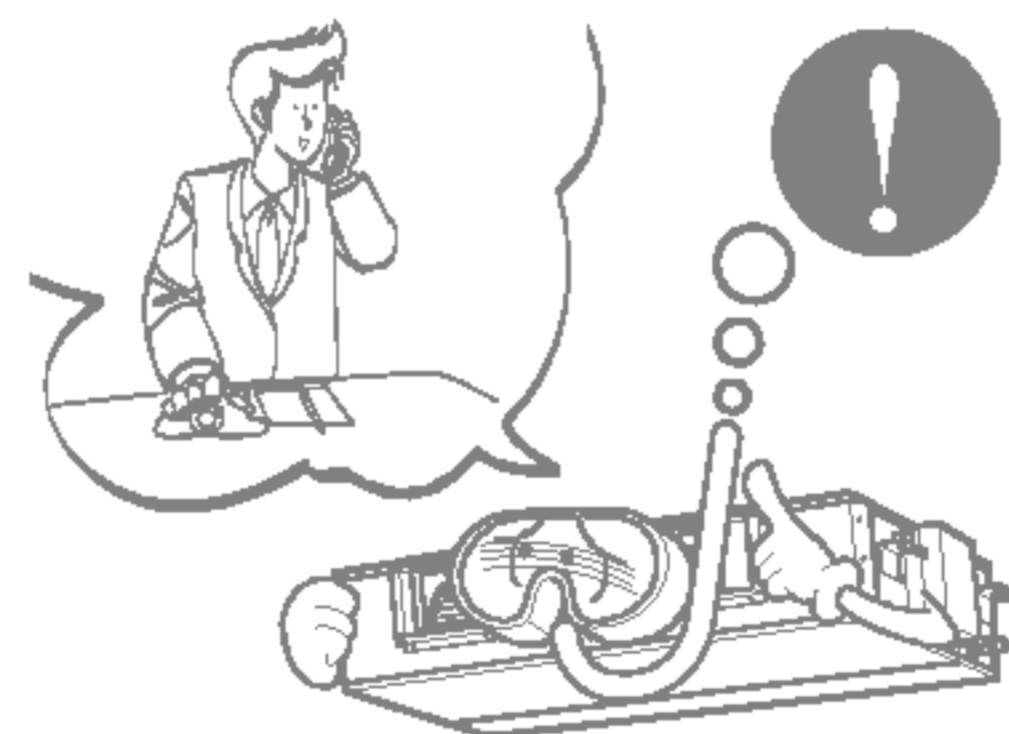

Be cautious that water could not enter the product.

- There is risk of fire, electric shock, or product damage.

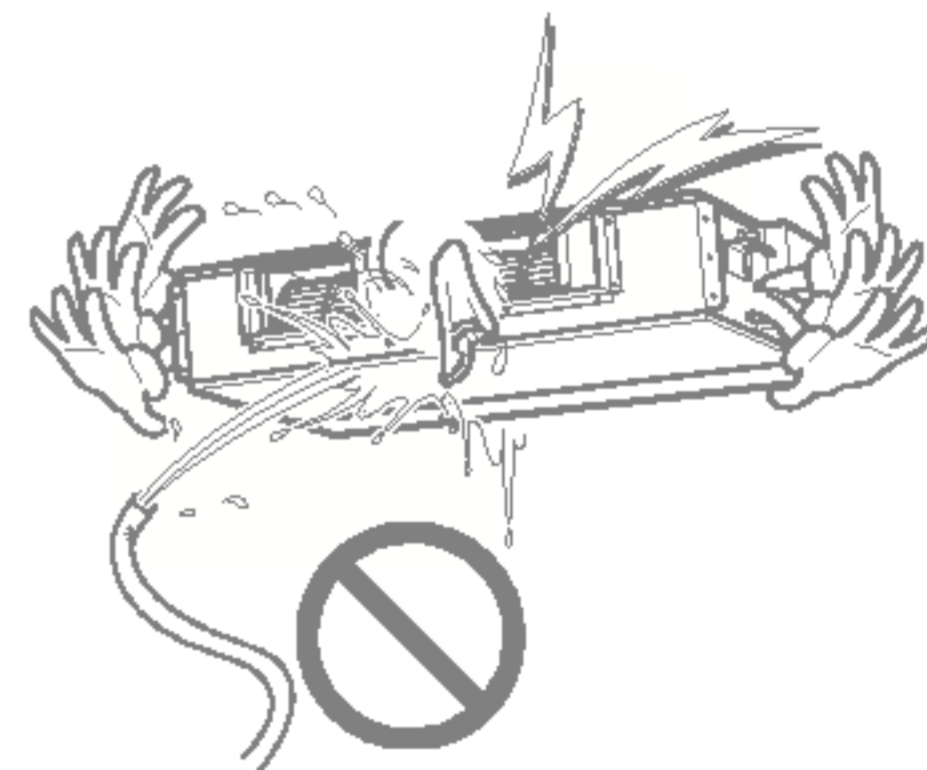

Ventilate the product from time to time when operating it together with a stove, etc.

- There is risk of fire or electric shock.

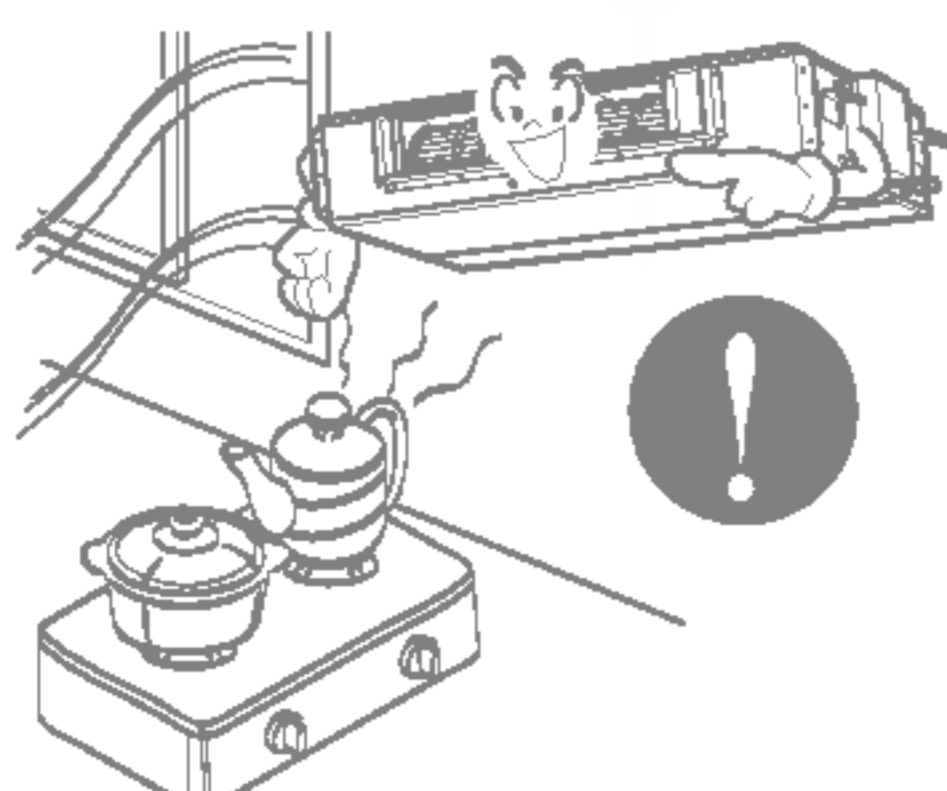

Turn the main power off when cleaning or maintaining the product.

- There is risk of electric shock.

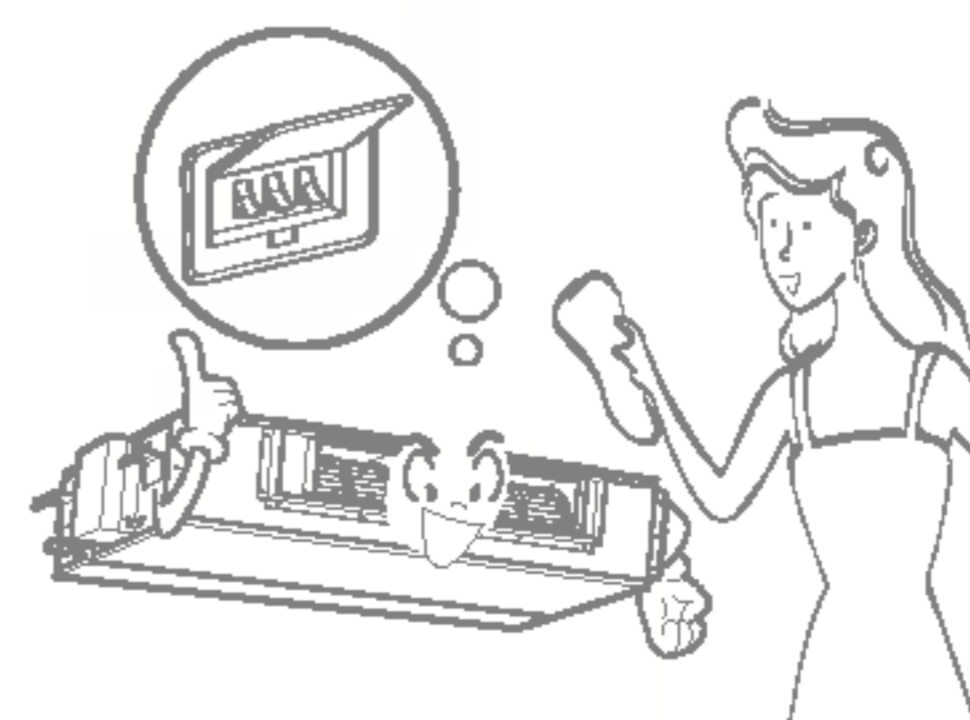

When the product is not be used for a long time, disconnect the power supply plug or turn off the breaker.

- There is risk of product damage or failure, or unintended operation.

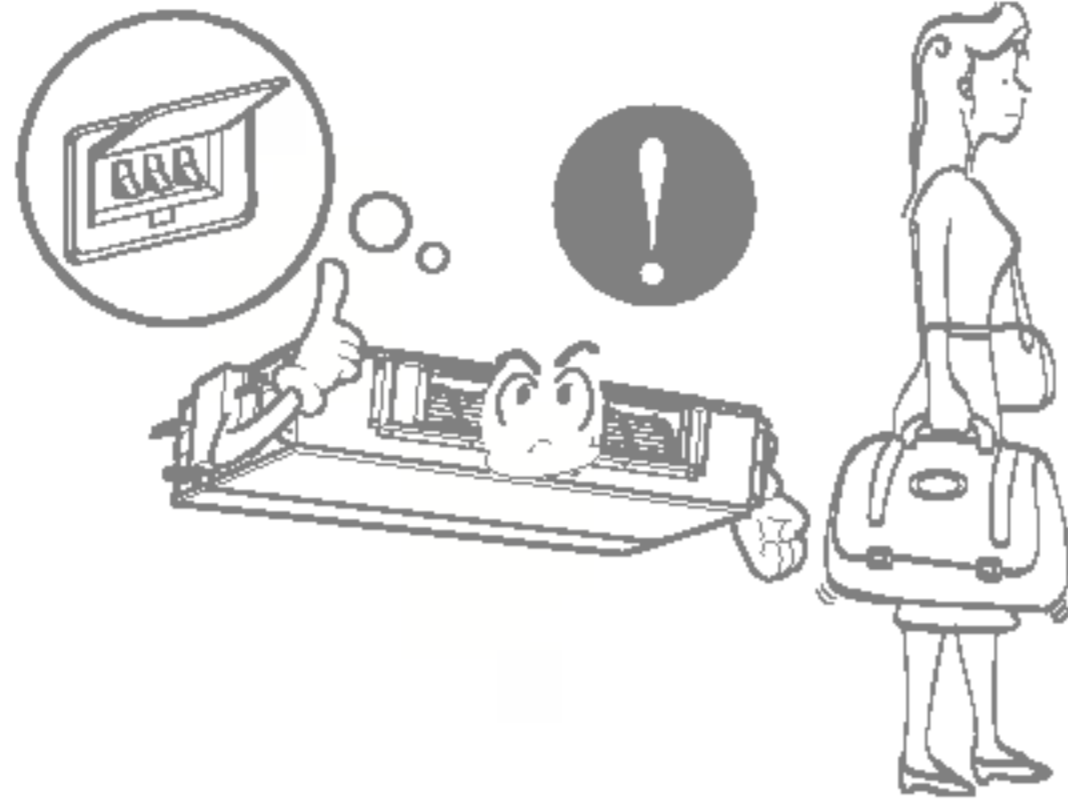

Take care to ensure that nobody could step on or fall onto the outdoor unit.

- This could result in personal injury and product damage.

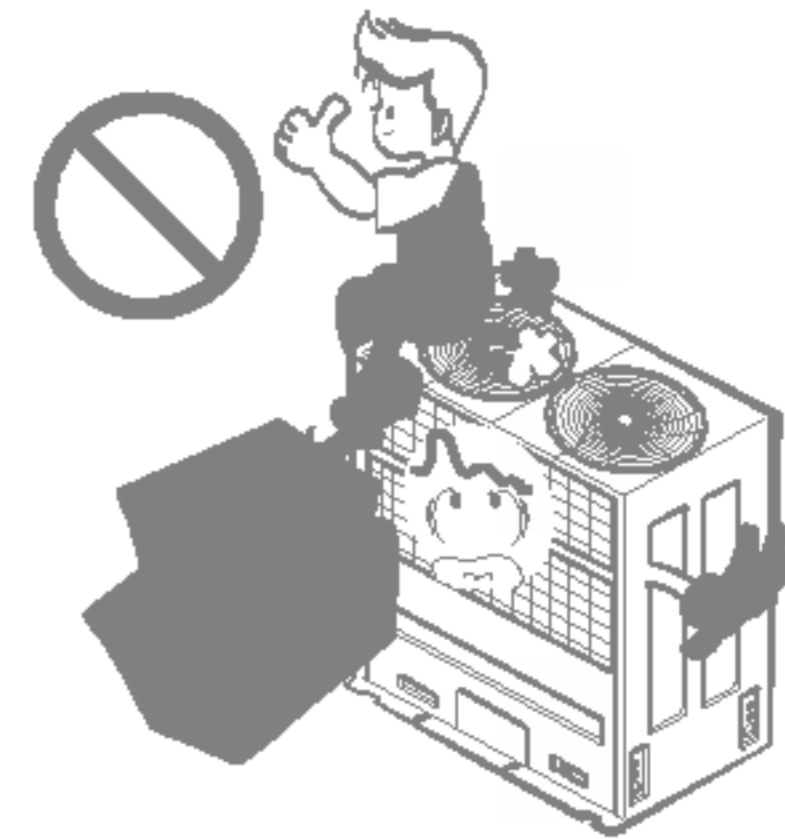

! CAUTION

■ Installation

Always check for gas (refrigerant) leakage after installation or repair of product.

- Low refrigerant levels may cause failure of product.

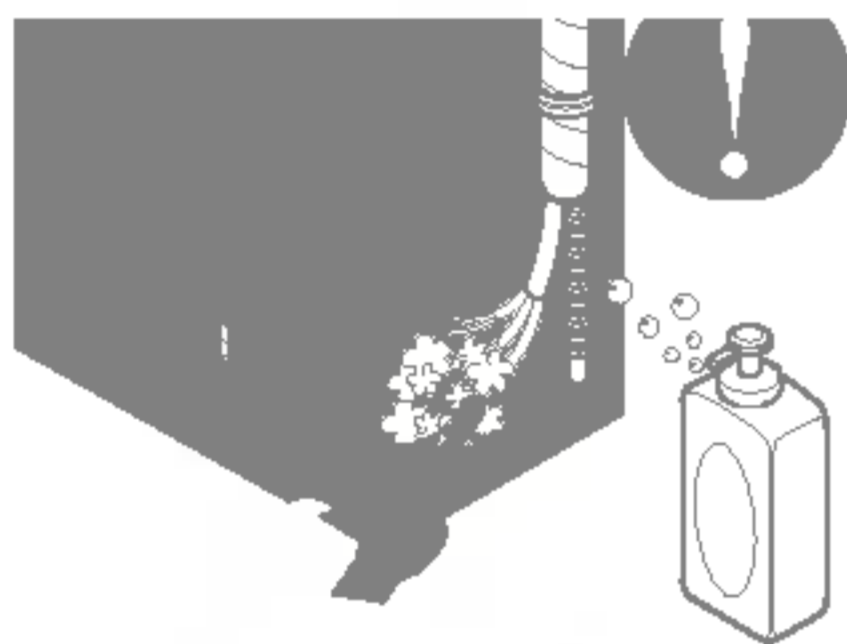

Install the drain hose to ensure that water is drained away properly.

- A bad connection may cause water leakage.

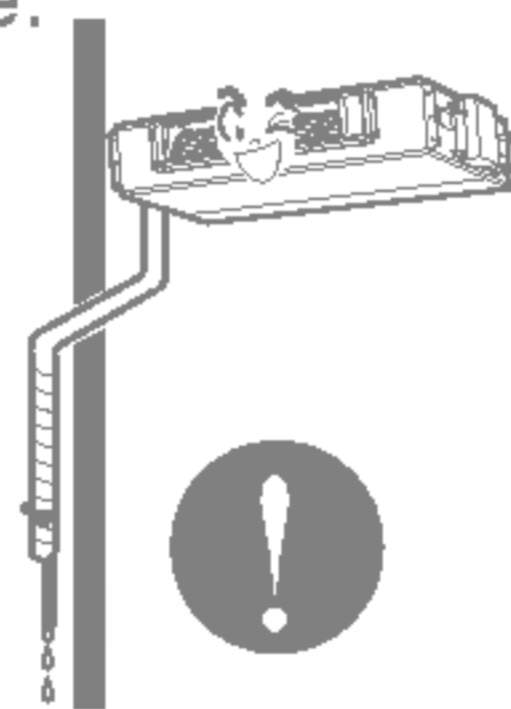

Keep level even when installing the product.

- To avoid vibration or water leakage.

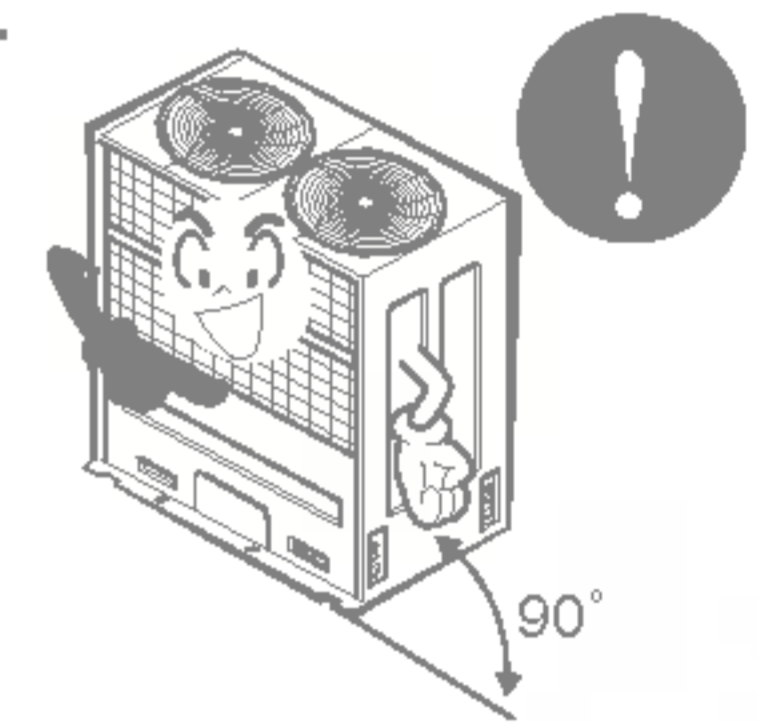

Do not install the product where the noise or hot air from the outdoor unit could damage the neighborhoods.

- It may cause a problem for your neighbors.

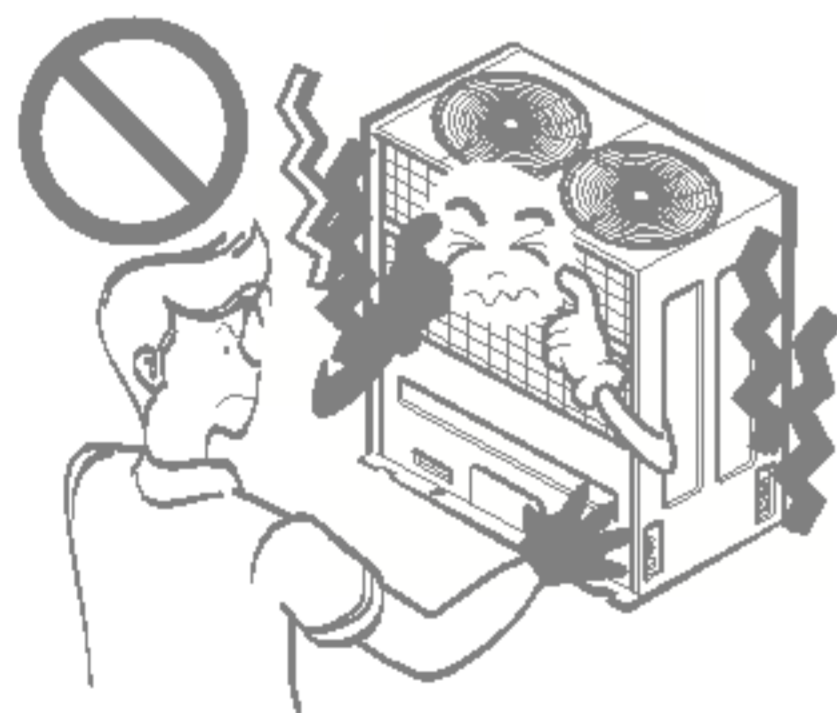

Use two or more people to lift and transport the product.

- Avoid personal injury.

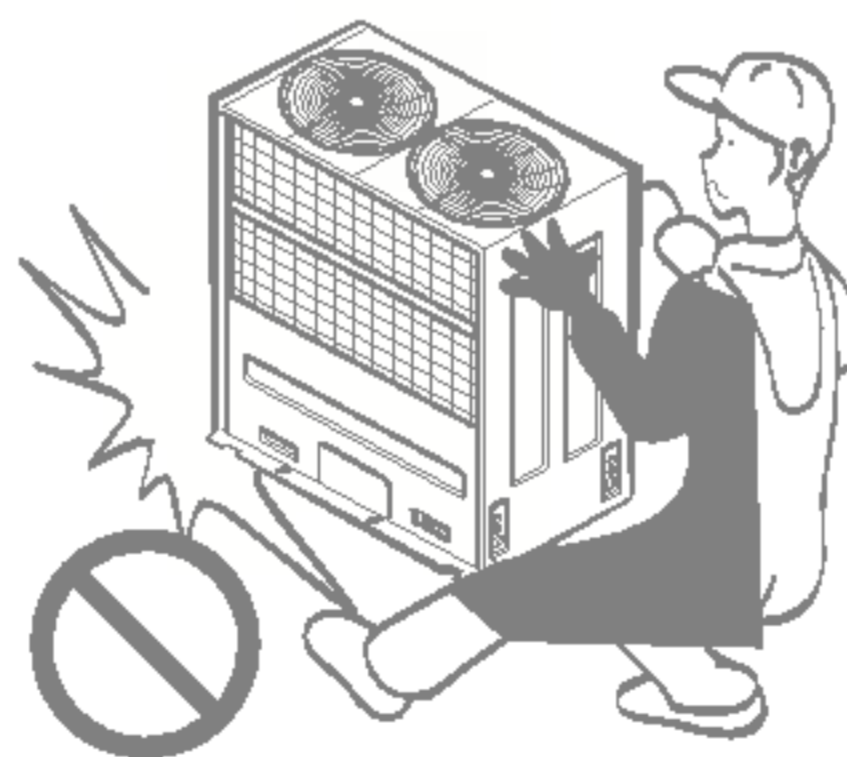

Do not install the product where it will be exposed to sea wind (salt spray) directly.

- It may cause corrosion on the product. Corrosion, particularly on the condenser and evaporator fins, could cause product malfunction or inefficient operation.

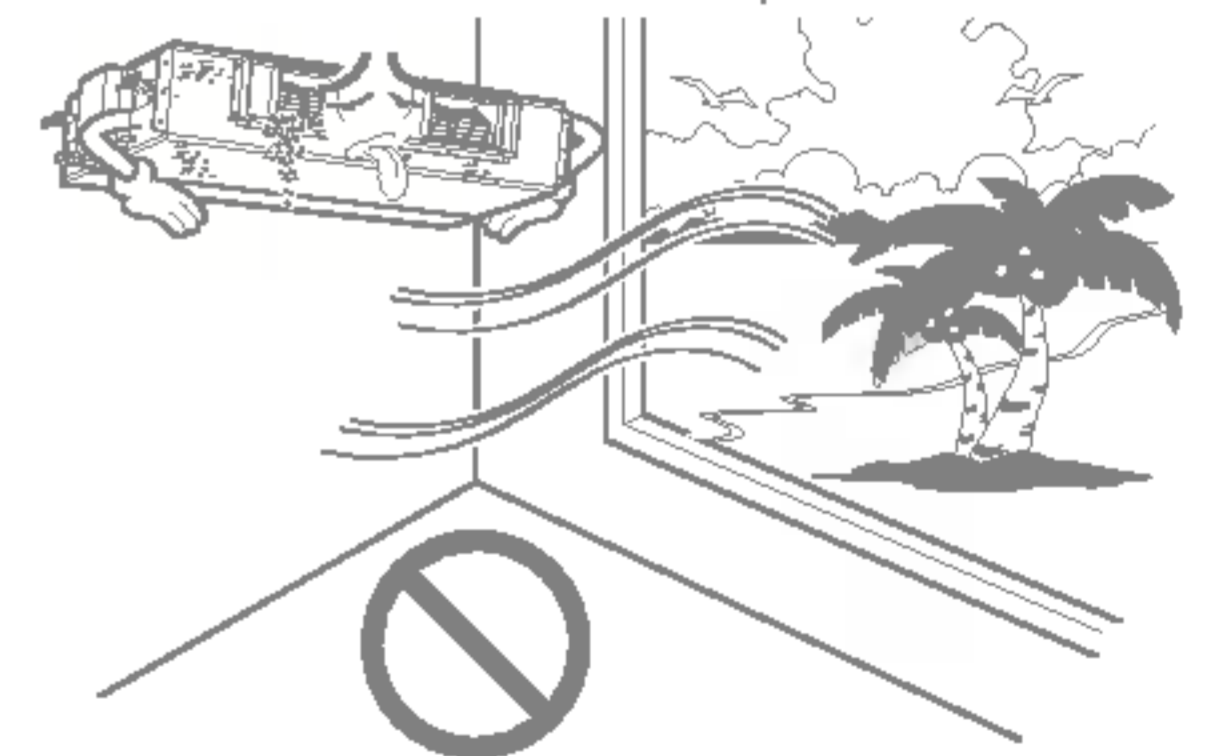

■ Operation

Do not expose the skin directly to cool air for long periods of time. (Don't sit in the draft.)

- This could harm to your health.

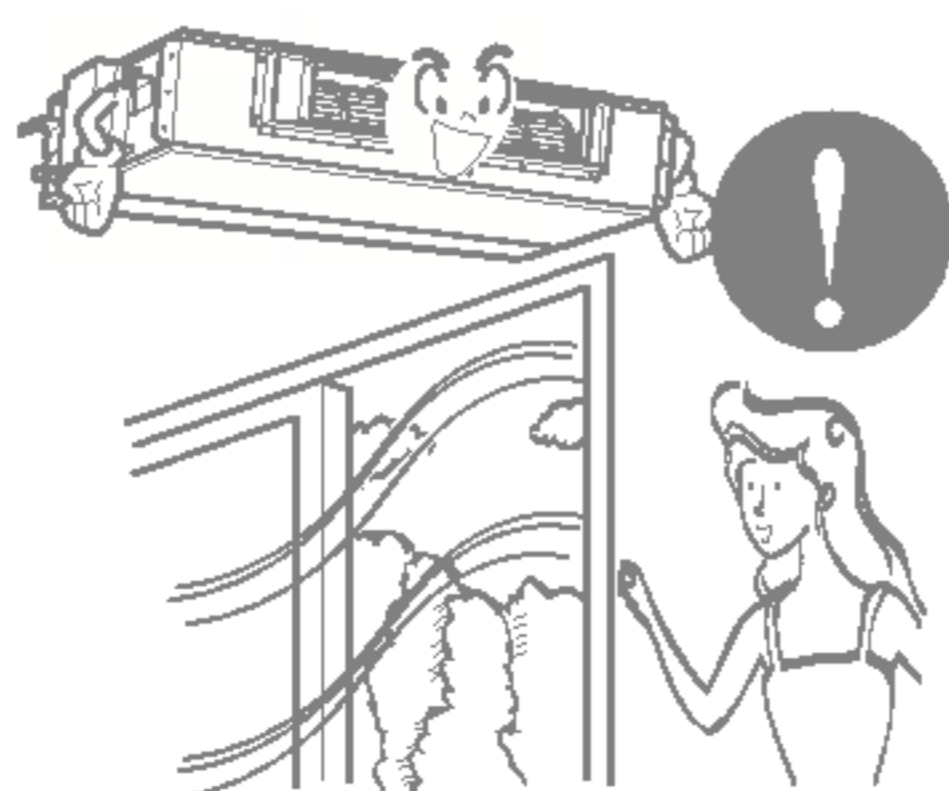

Do not use the product for special purposes, such as preserving foods, works of art, etc. It is a consumer air conditioner, not a precision refrigeration system.

- There is risk of damage or loss of property.

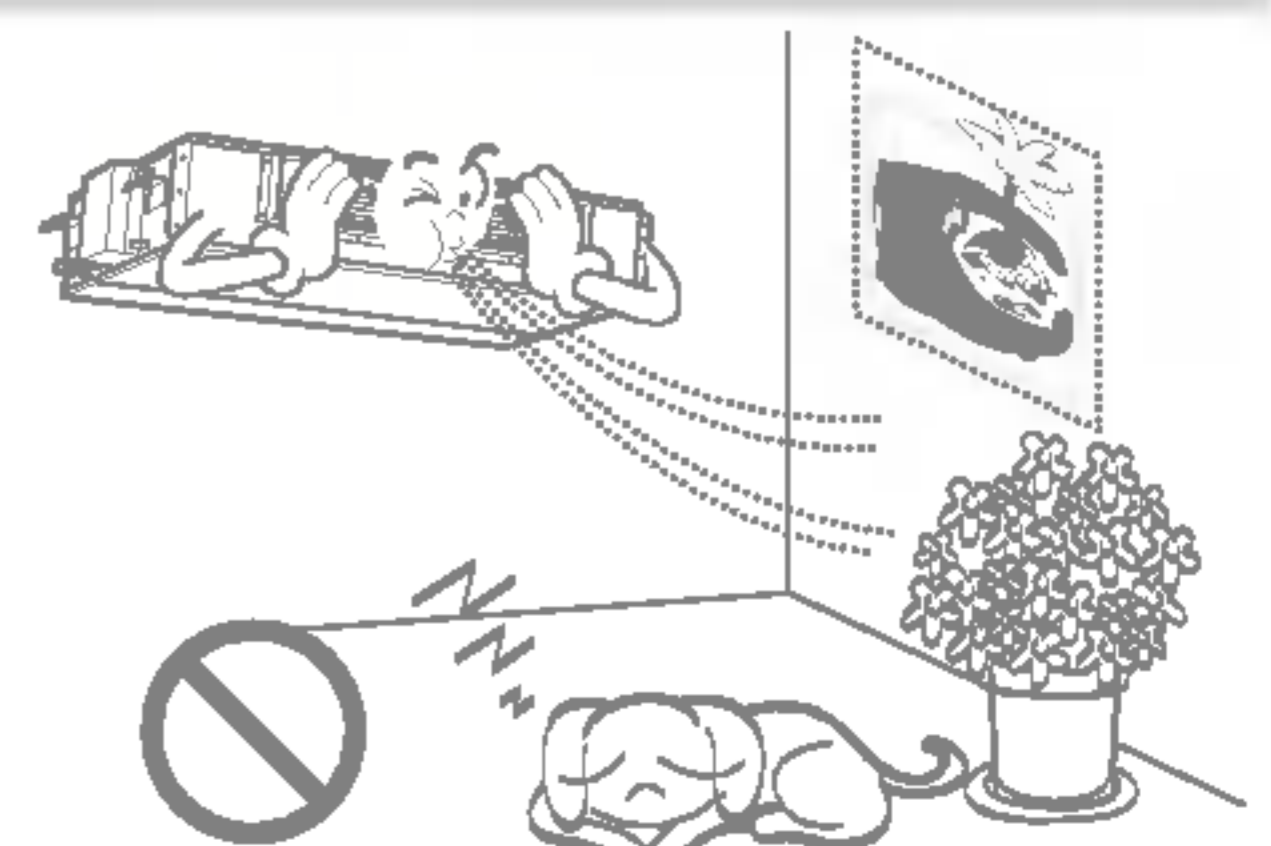

Do not block the inlet or outlet of air flow.

- It may cause product failure.

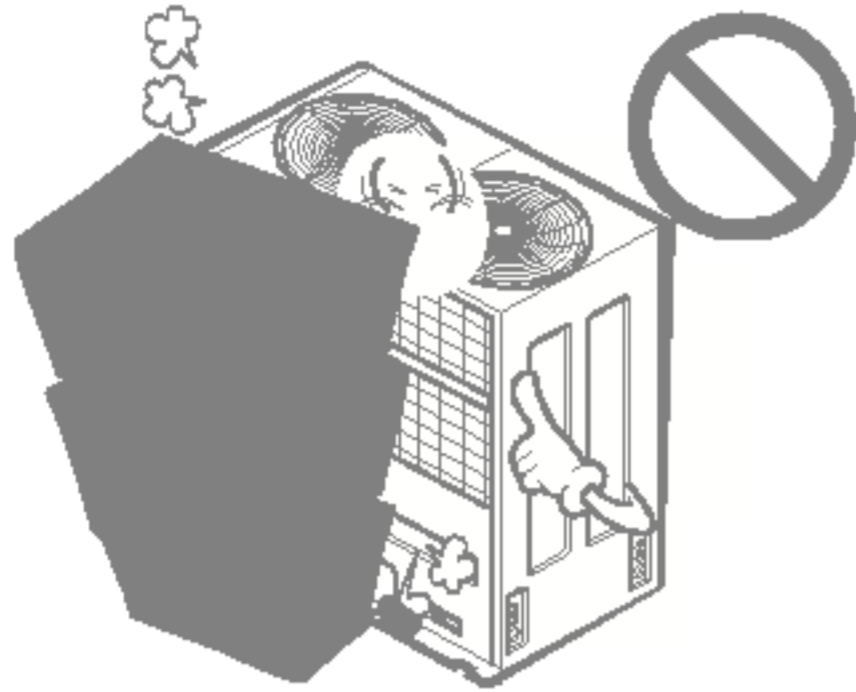

Use a soft cloth to clean. Do not use harsh detergents, solvents, etc.

- There is risk of fire, electric shock, or damage to the plastic parts of the product.

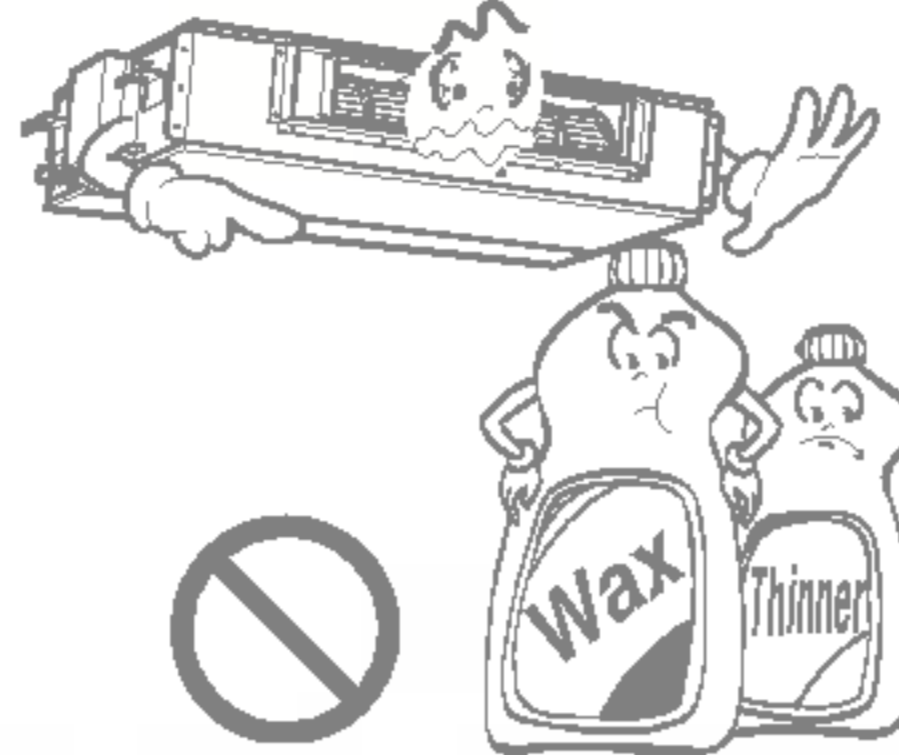

Do not touch the metal parts of the product when removing the air filter. They are very sharp!

- There is risk of personal injury.

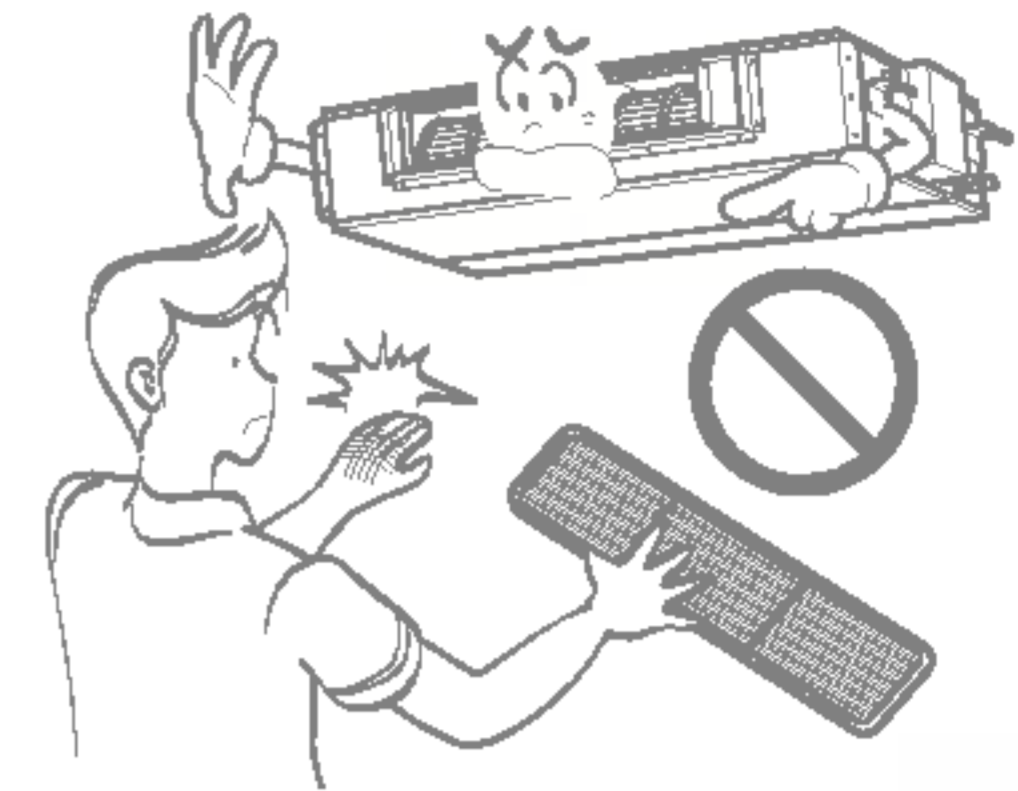

Do not step on or put anything on the product. (outdoor units)

- There is risk of personal injury and failure of product.

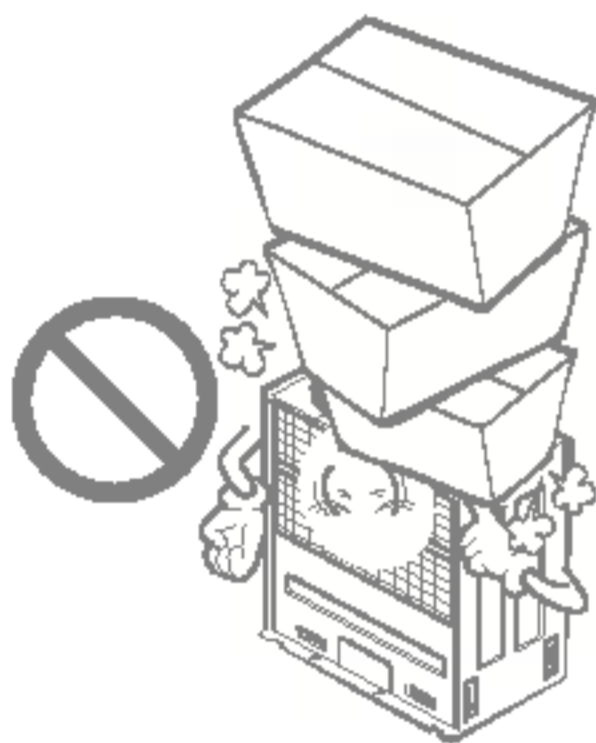

Always insert the filter securely. Clean the filter every two weeks or more often if necessary.

- A dirty filter reduces the efficiency of the air conditioner and could cause product malfunction or damage.

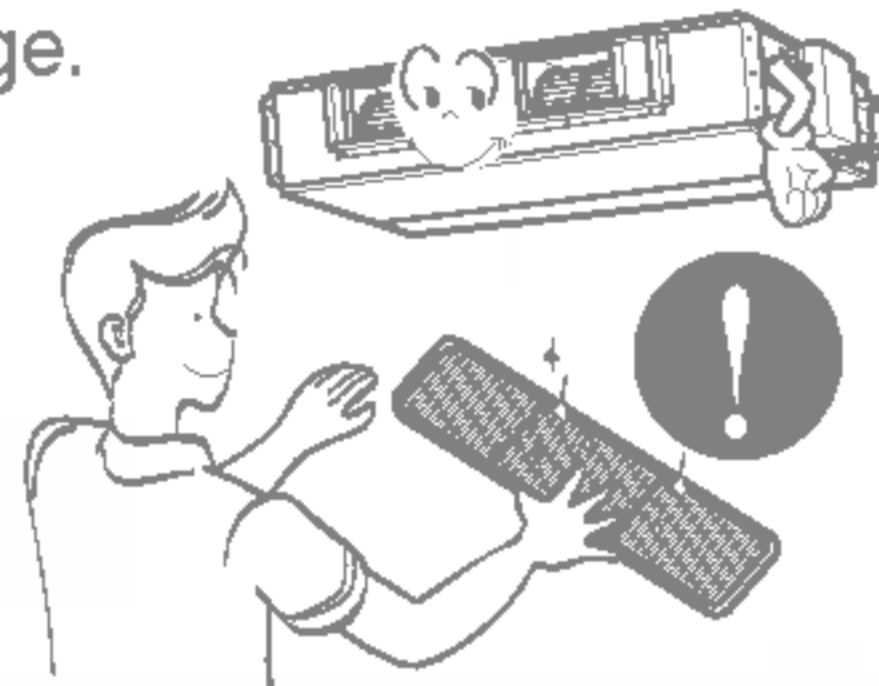

Do not insert hands or other objects through the air inlet or outlet while the product is operated.

- There are sharp and moving parts that could cause personal injury.

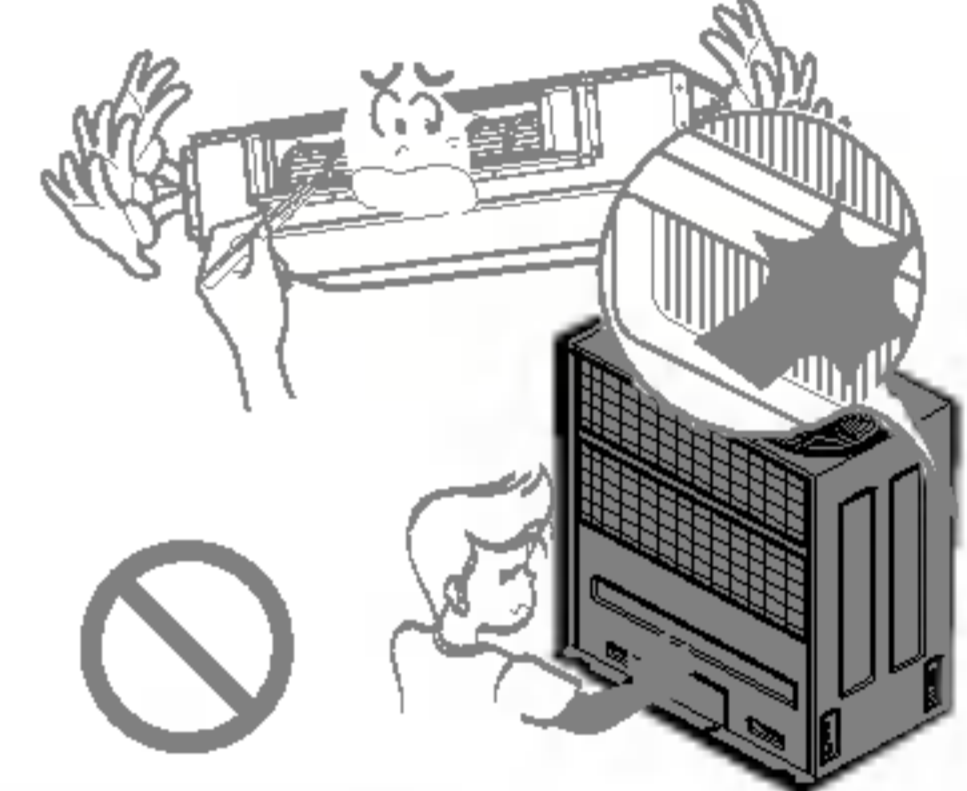

Do not drink the water drained from the product.

- It is not sanitary and could cause serious health issues.



Use a firm stool or ladder when cleaning or maintaining the product.

- Be careful and avoid personal injury.

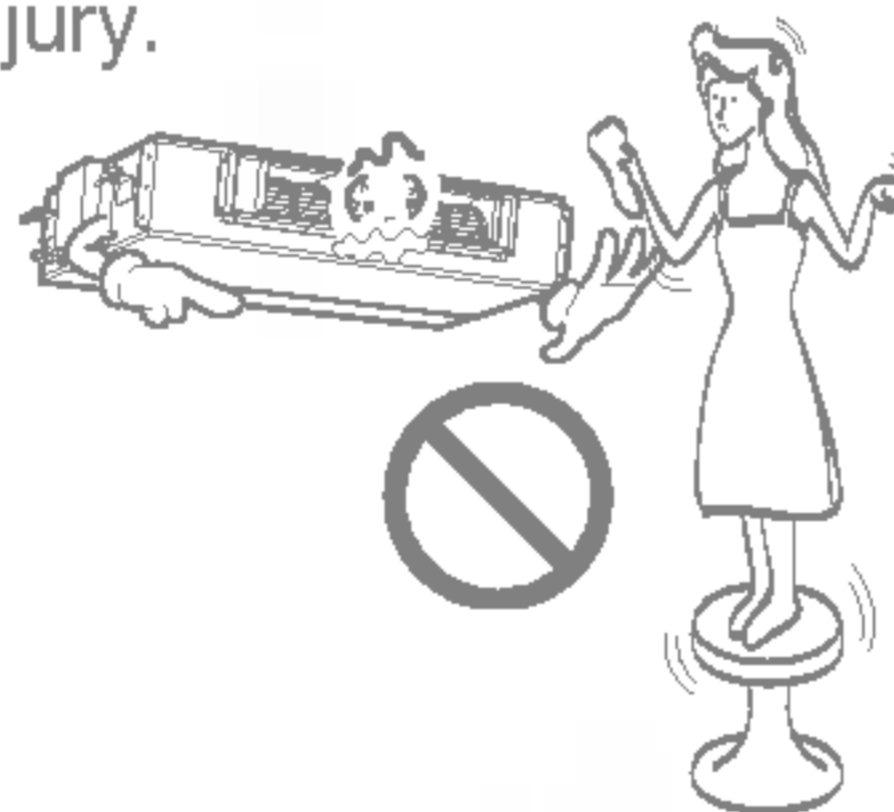

Replace the all batteries in the remote control with new ones of the same type. Do not mix old and new batteries or different types of batteries.

- There is risk of fire or explosion

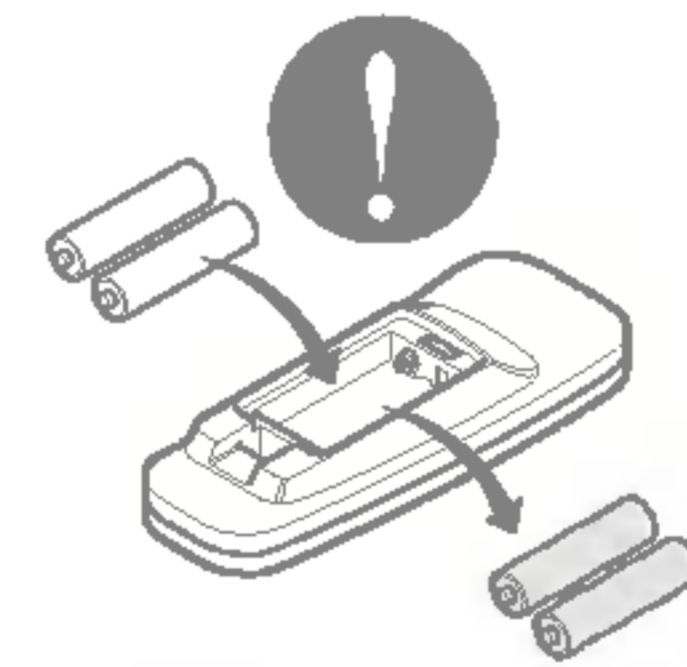

Do not recharge or disassemble the batteries. Do not dispose of batteries in a fire.

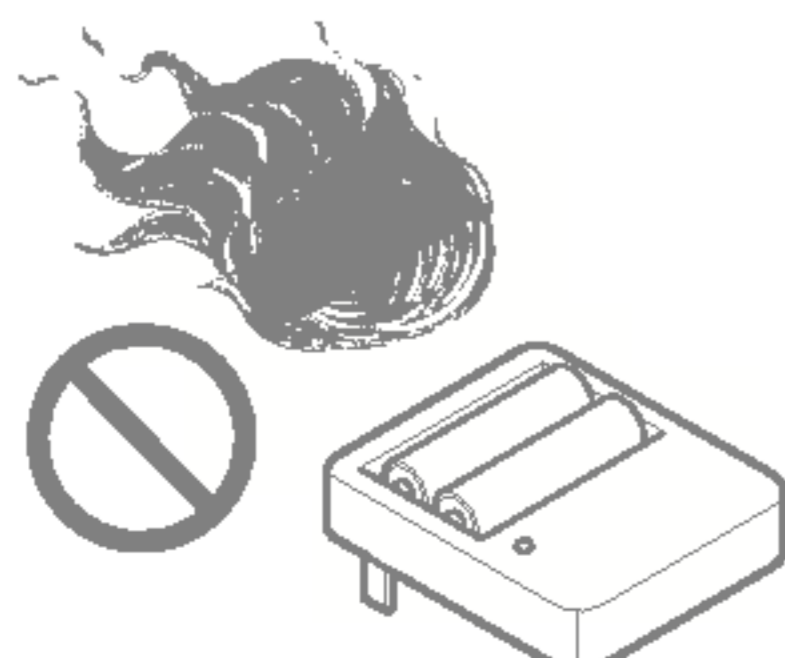

- They may burn or explode.





If the liquid from the batteries gets onto your skin or clothes, wash it well with clean water. Do not use the remote if the batteries have leaked.

- The chemicals in batteries could cause burns or other health hazards.



- 
- 
1. Contact an installation specialist for installation.
 2. Use a dedicated circuit.

- 
1. Being exposed to direct airflow for an extended period of time could be hazardous to your health. Do not expose occupants, pets, or plants to direct airflow for extended periods of time.
 2. Due to the possibility of oxygen deficiency, ventilate the room when used together with stoves or other heating devices.
 3. Do not use this air conditioner for non-specified special purposes (e.g. preserving precision devices, food, pets, plants, and art objects). Such usage could damage the items.

- 
1. Do not touch the metal parts of the unit when removing the filter. Injuries can occur when handling sharp metal edges.
 2. Do not use water to clean inside the air conditioner. Exposure to water can destroy the insulation, leading to possible electric shock.
 3. When cleaning the unit, first make sure that the power and breaker are turned off. The fan rotates at a very high speed during operation. There is a possibility of injury if the unit's power is accidentally triggered on while cleaning inner parts of the unit.



For repair and maintenance, contact your authorized service dealer.

Wired Type

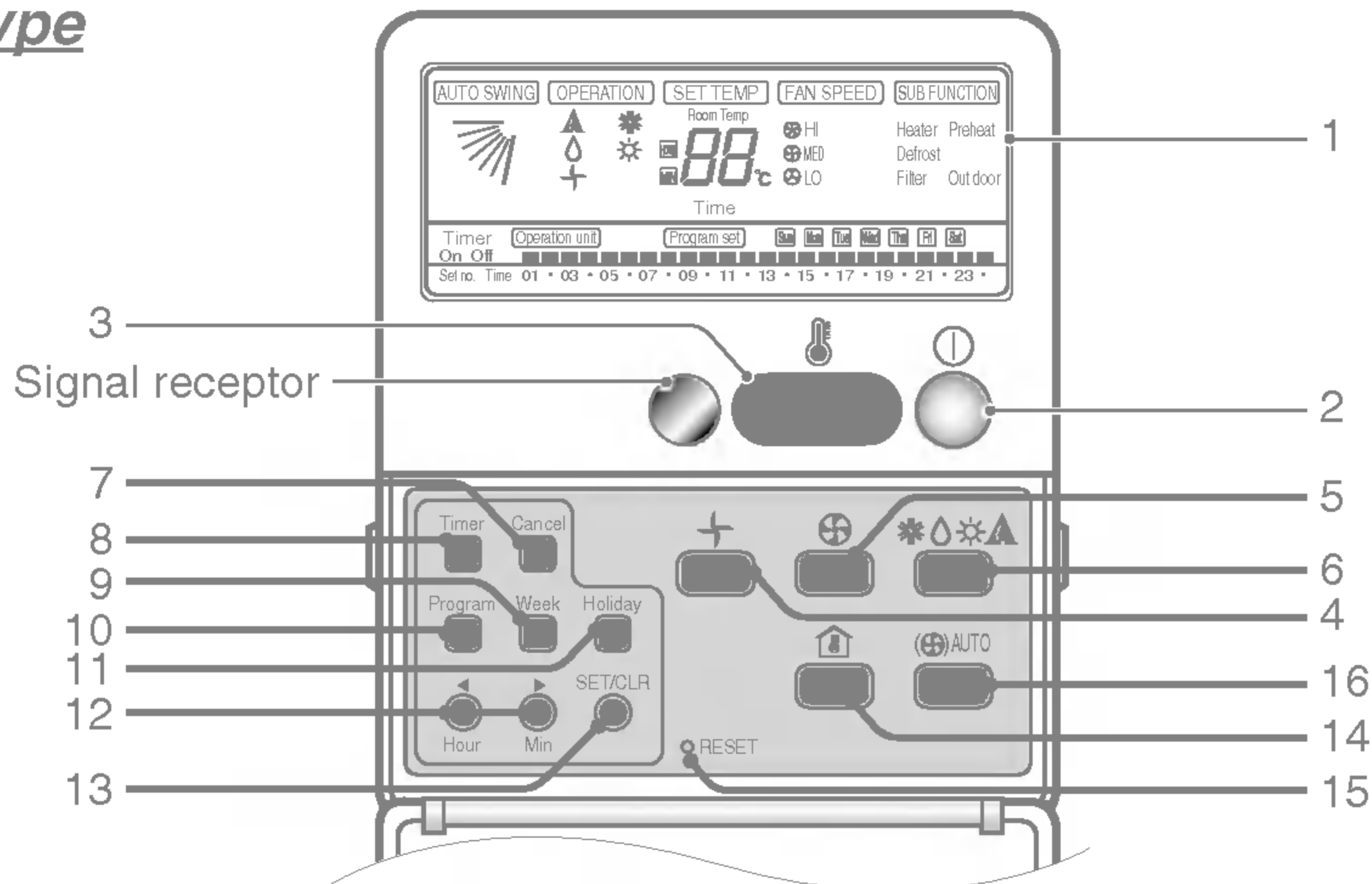

1. Operation display

Displays the operation conditions.

2. On/Off Button

Operation starts when this button is pressed, and stops when the button is pressed again.

3. Set Temperature Button

Used to set the temperature when the desired temperature is obtained.

4. FAN Operation Button

Used to circulate room air without cooling or heating.

5. Fan Speed Button

Used to set desired fan speed.

6. Operation Mode Selection Button

Used to select the operation mode.

- Auto Operation Mode.
- Cooling Operation Mode.
- Soft Dry Operation Mode.
- Heating Operation Mode.(except cooling model)

7. Timer Cancel Button

Used to cancel the timer.

8. Timer Set Button

Used to set the timer when the desired time is obtained.

9. Week Button

Used to set a day of the week.

10. Program Button

Used to set the weekly timer.

11. Holiday Button

Used to set a holiday of the week.

12. Time Set Button

Used to set the time of the day and change the time in the weekly timer Function.

13. Set and Clear Button

Used to set and clear the weekly timer.

14. Room Temperature Checking Button

Used to check the room temperature.

15. Reset Button

Used to set the current time and clear the setting time.

16. Auto Function Button

Not used function.

Wireless Type(Optional)

This air-conditioner is equipped with wired remote control basically. But if you want to be available with wireless remote control, you pay for it.

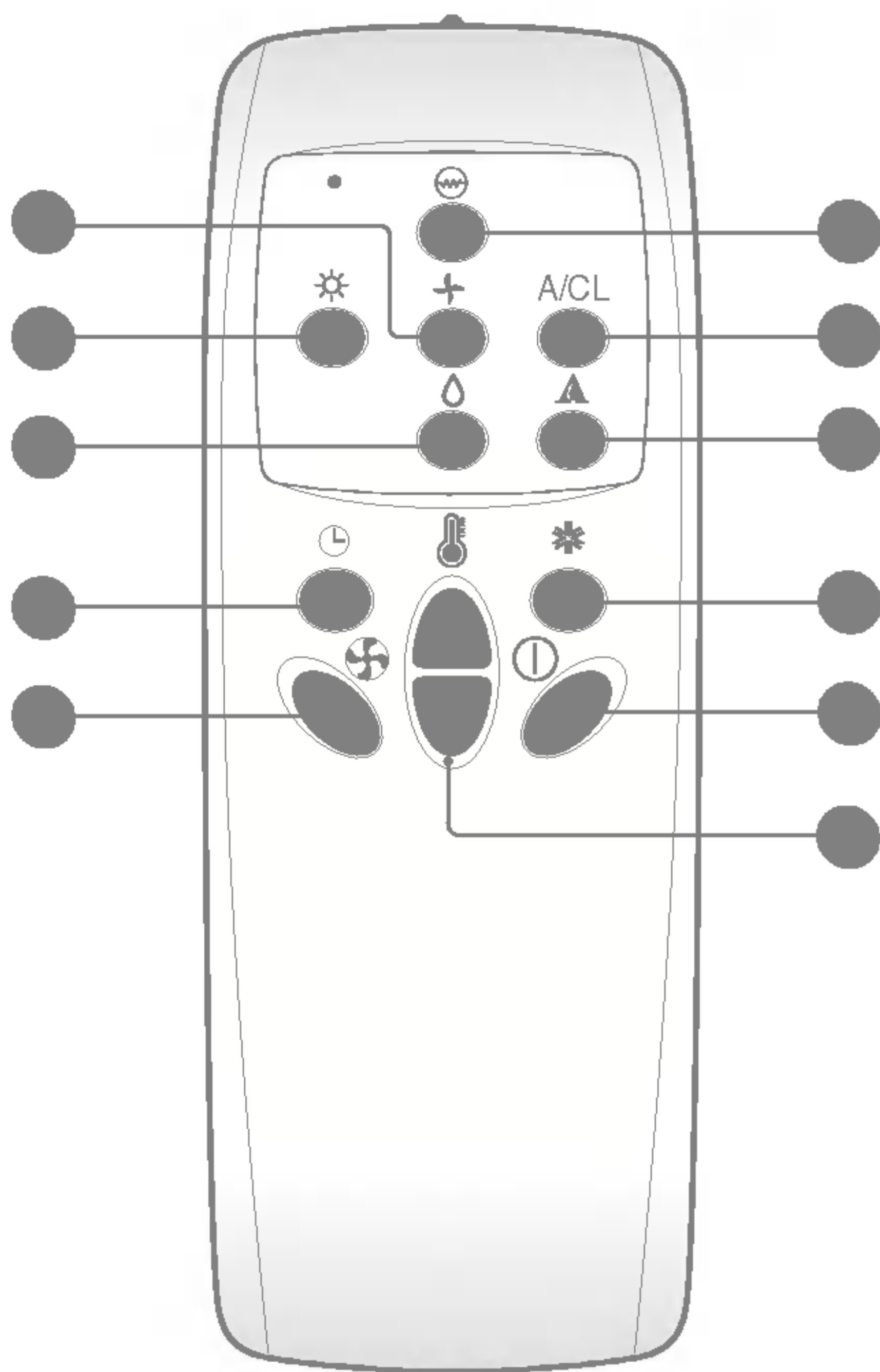

- **FAN Operation Button**
Used to circulate room air without cooling or heating.
- **Cooling Operation Button**
- **Soft Dry Operation Button**
Used to dehumidify without overcooling.
- **Heating Operation Button**
(Heat pump model only)
- **Timer Set Button**
Used to set the timer when the desired time is obtained.
Then the wired remote controller is set up to 24 hours by an hour but the wireless remote controller is set up to 7 hours by an hour. Therefore, if you want to set over 7 hours, use the wired remote controller.
- **Fan Speed Button**
Used to set the desired fan speed.
- **On/Off Button**
Operation starts when this button is pressed, and stops when the button is pressed again.
- **Set Temperature Button**
Used to set the temperature when the desired temperature is obtained
- **Auto Operation Button**
- **Plasma Air Clean Button(Optional)**
- **Electric Heater Button(Optional: 48/60k ZL/ZA/ZP Model only)**
Used to set the Electric Heater.



CAUTION of handling the Remote Control

for handling the Remote Controller

- Aim at the signal receptor on the wired remote controller so as to operate.
- The remote control signal can be received at a distance of up to about 7m.
- Be sure that there are no obstructions between the remote controller and the signal receptor.
- Do not drop or throw the remote controller.
- Do not place the remote controller in a location exposed to direct sunlight, or near the heating unit, or any other heat source.
- Block a strong light over the signal receptor with a curtain or etc. so as to prevent the abnormal operation.
(ex:electronic quick start, ELBA, inverter type fluorescent lamp)



Set the Current Time and a day of the Week

1 Press the '  ' button.

Hour

Each time the button is pressed, the number is changed from 00 to 23.
You can set the number of the current hour.

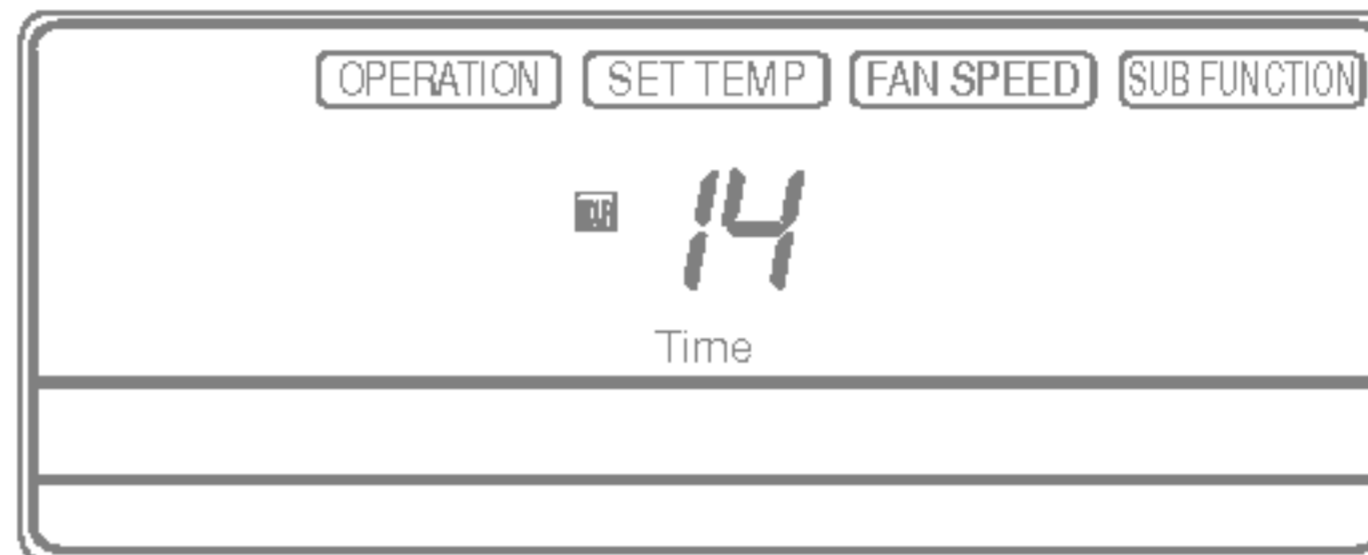

2 Press the '  ' button.

Min

Each time the button is pressed, the number is increased from 00 to 59.
You can set the number of the current minute.

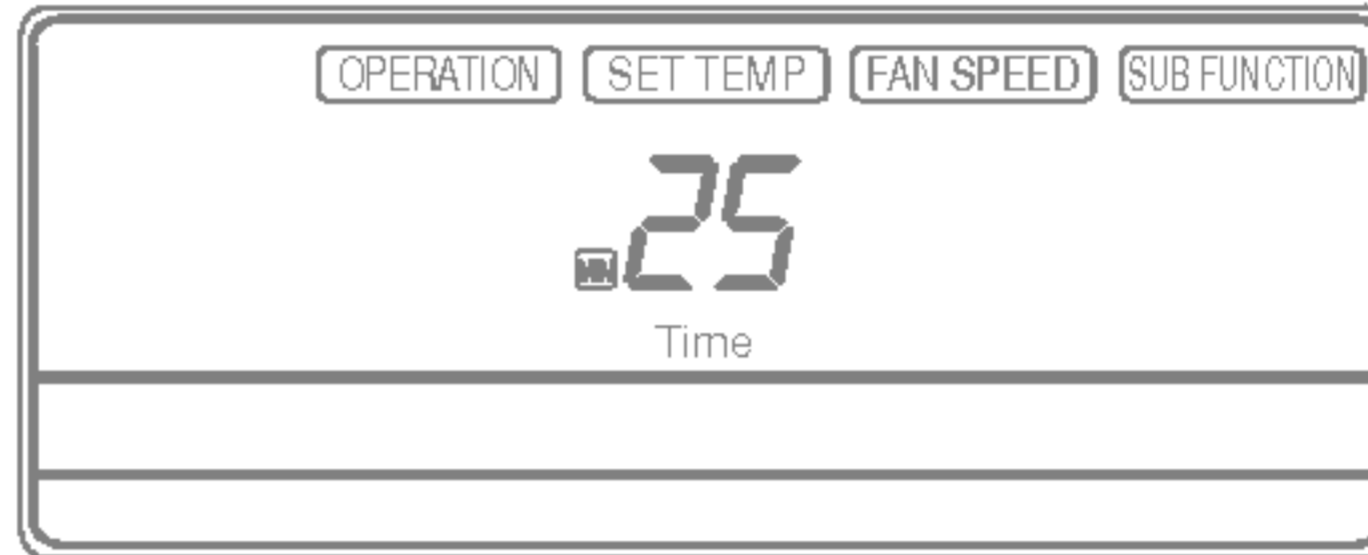
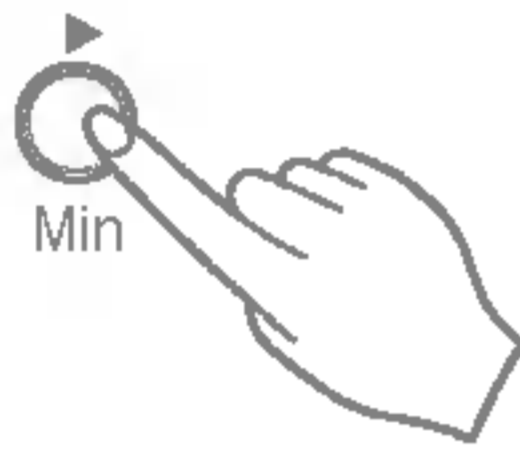

3 Press '  ' button.

Week

Each time the button is pressed, a day of the week is shifted from Sunday to Saturday.
You can set the day of the week.

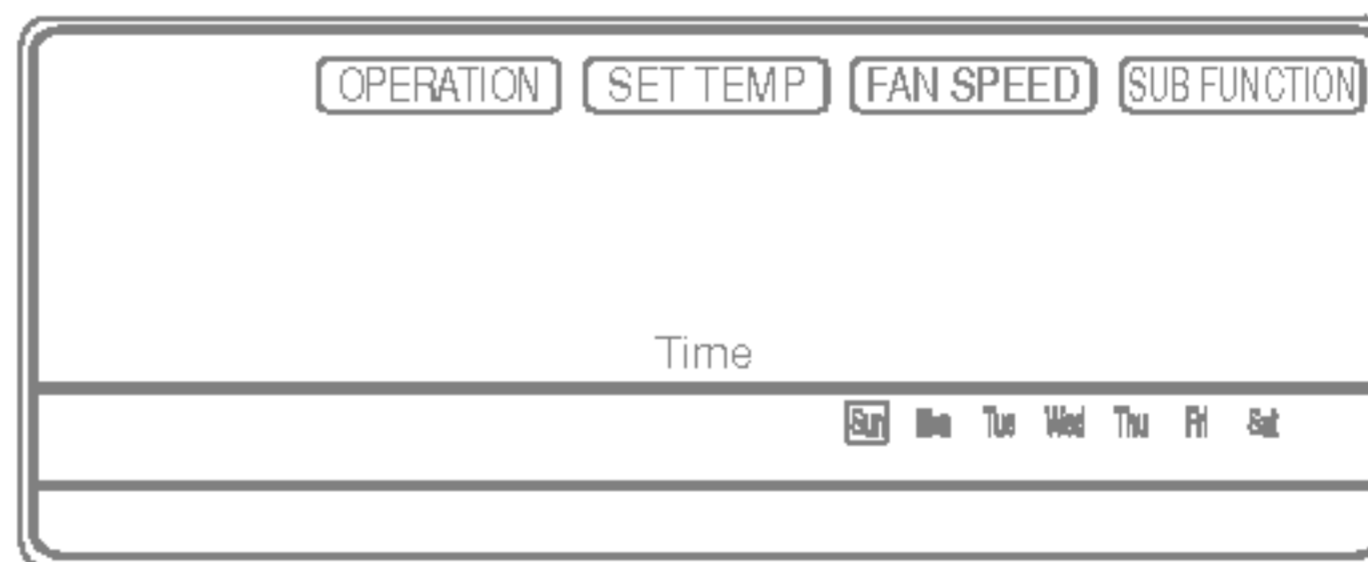

4 Press the '  RESET ' button.

If you want to reset the current time and a day of the week, click the Reset button.

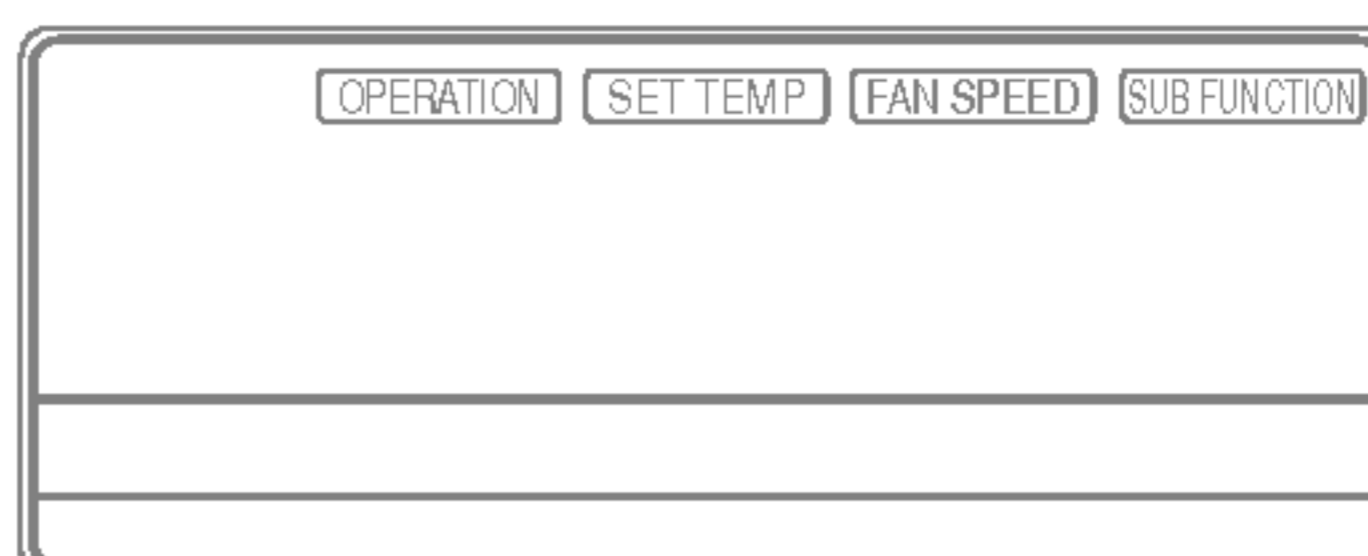



Weekly Programming

1 Press the Program button.

The remote controller is displayed like a picture. Then '  ', '  ' and '01' is blinked.

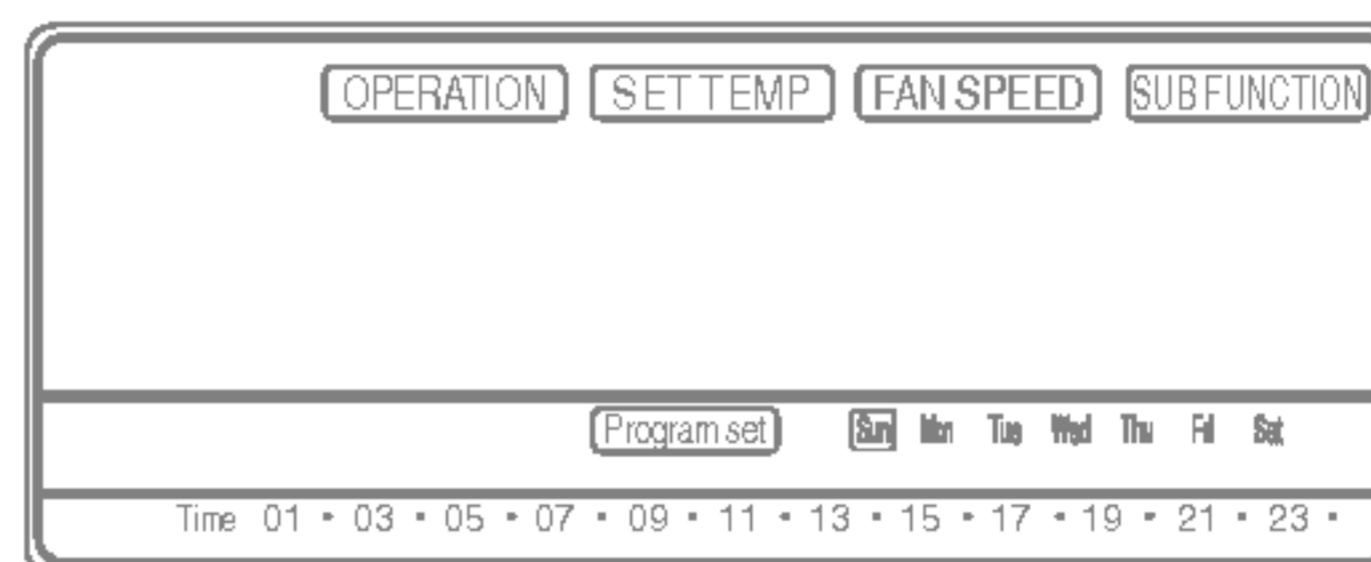

2 Press the '  ' button.

Select Monday.



3 Change the timer setting until the desired time is set.
After you select a time, push the SET/CLR button once or one more time.

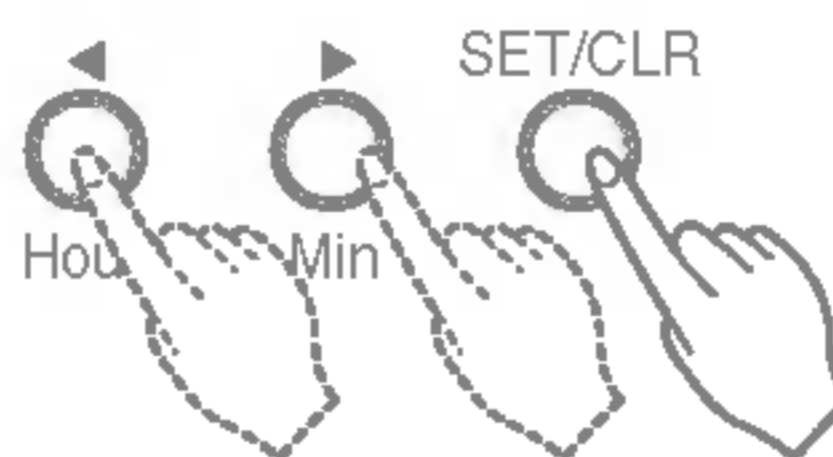

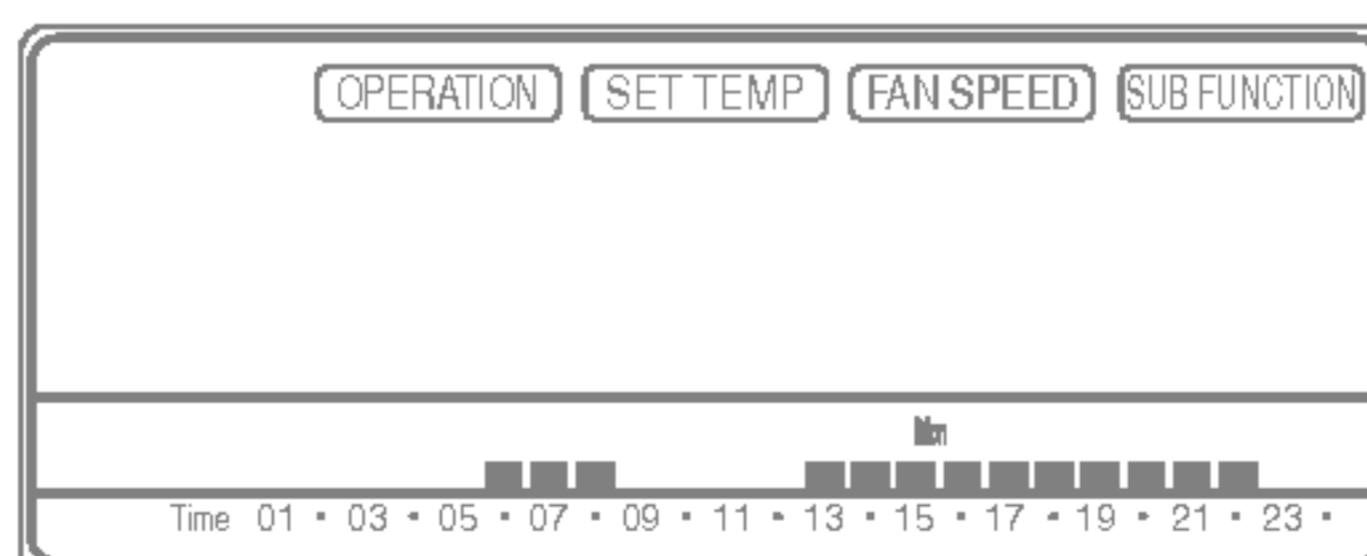

For Example if the air-conditioner is turned on from 6 to 8 and from 13 to 22 and turned off at other time monday, display is as follows. (black bar indicates turn-on, white bar indicates turn-off.)



4 You can set turn on and turn off time by the day in a week as above.

Holiday Setting

If Tuesday is a holiday in this week, you may set a holiday.

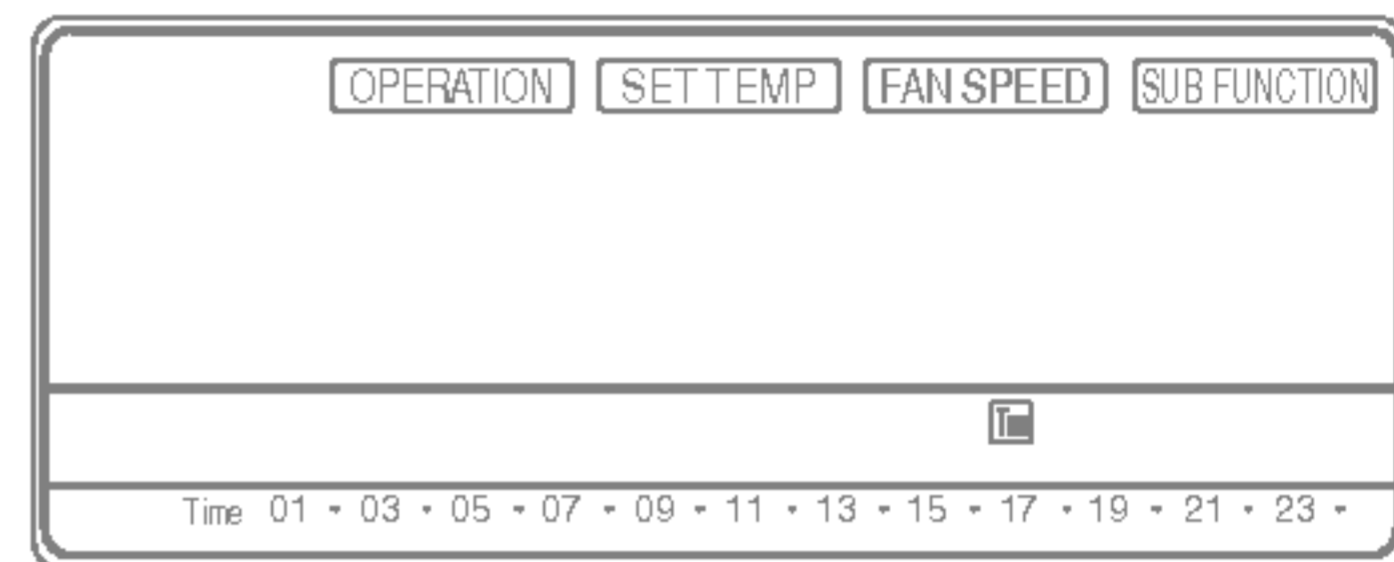

1. Press the Program button. 
2. Press the Week button. Select the Tuesday. 
3. Press the Holiday button. 

Then the remote controller will be displayed ' Tue '.
The outside rectangular means holiday.

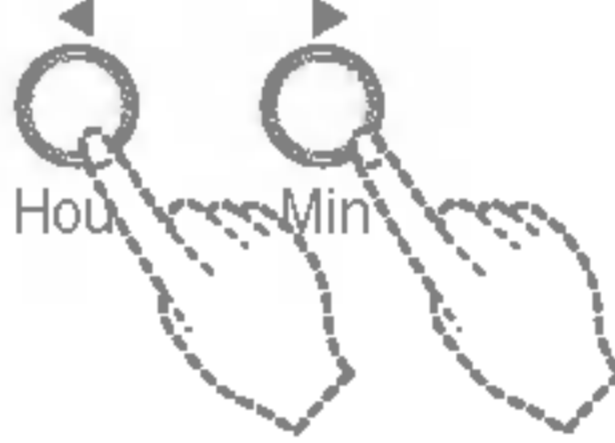

Timer Setting(Delay start/Pre-set stop)

This function is used to turn on or turn off in several hours.

1. Press the Timer button to turn Timer on or off. 
2. Change the timer setting until the desired time is set. 
3. If you want to cancel the timer setting, press the Cancel button. 

Operation Mode

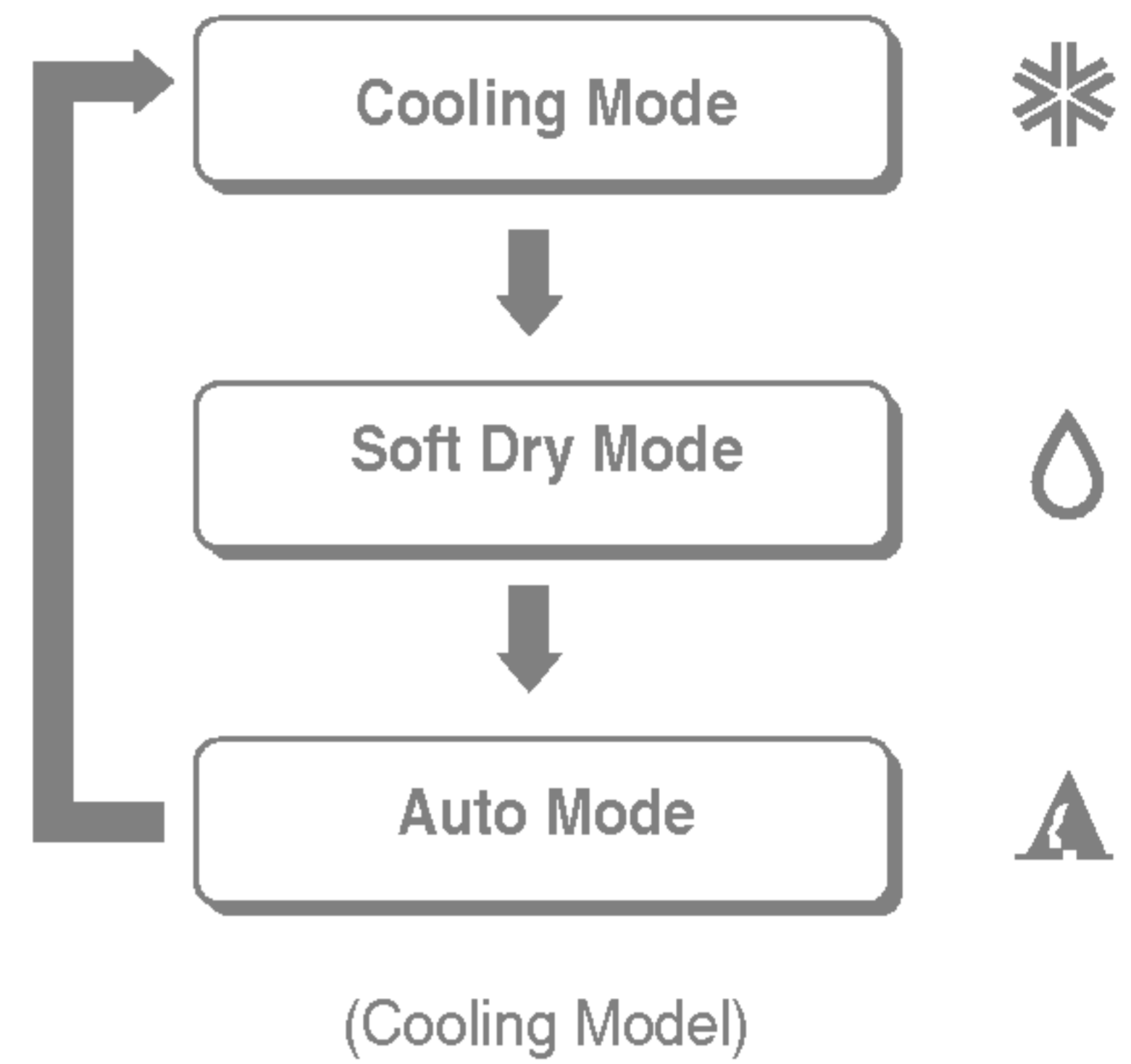
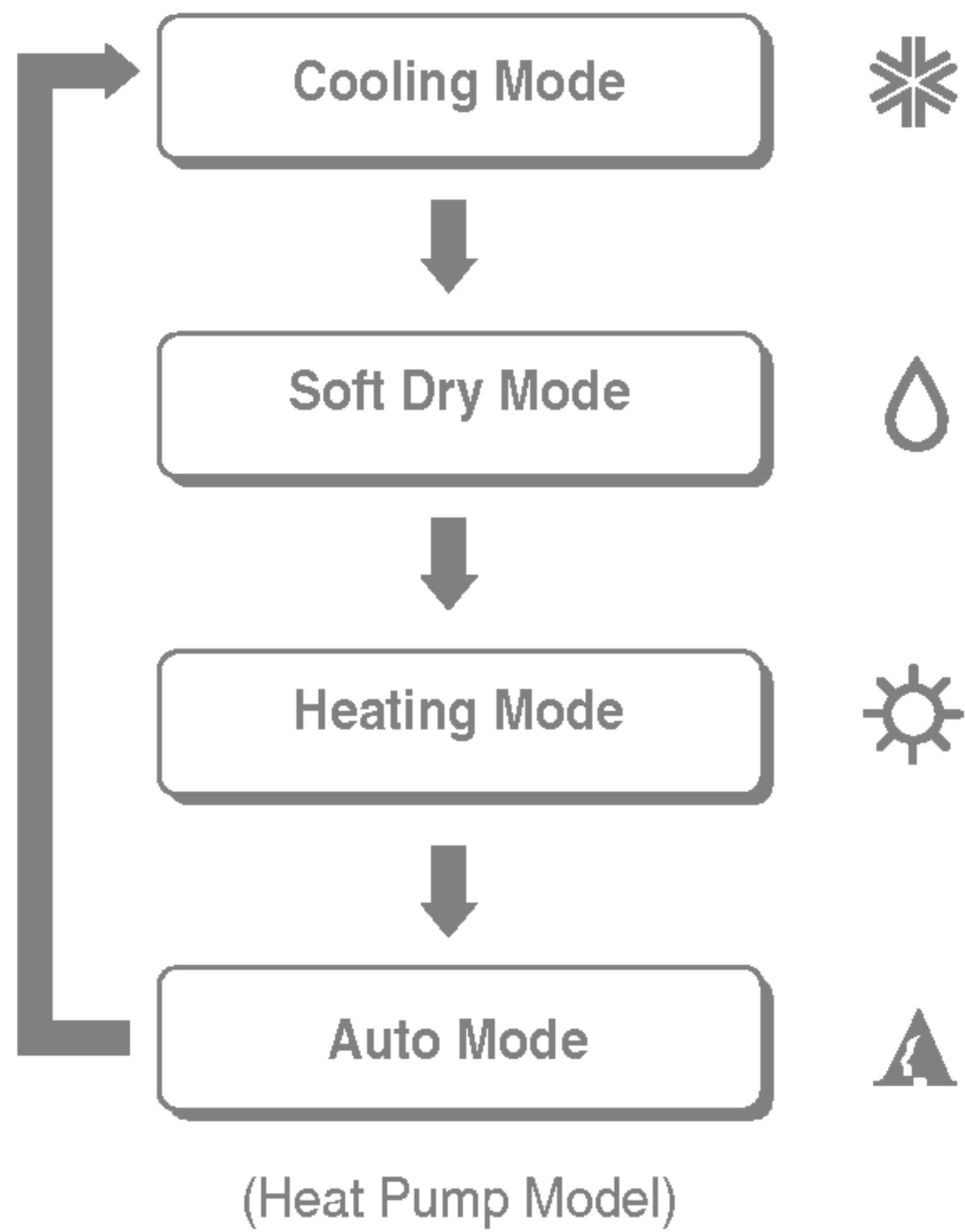

Operation Procedure

1st On/Off Button

2nd Operation Mode Selection Button

3rd Room Temperature Setting Button

4th Indoor Fan Speed Selection Button

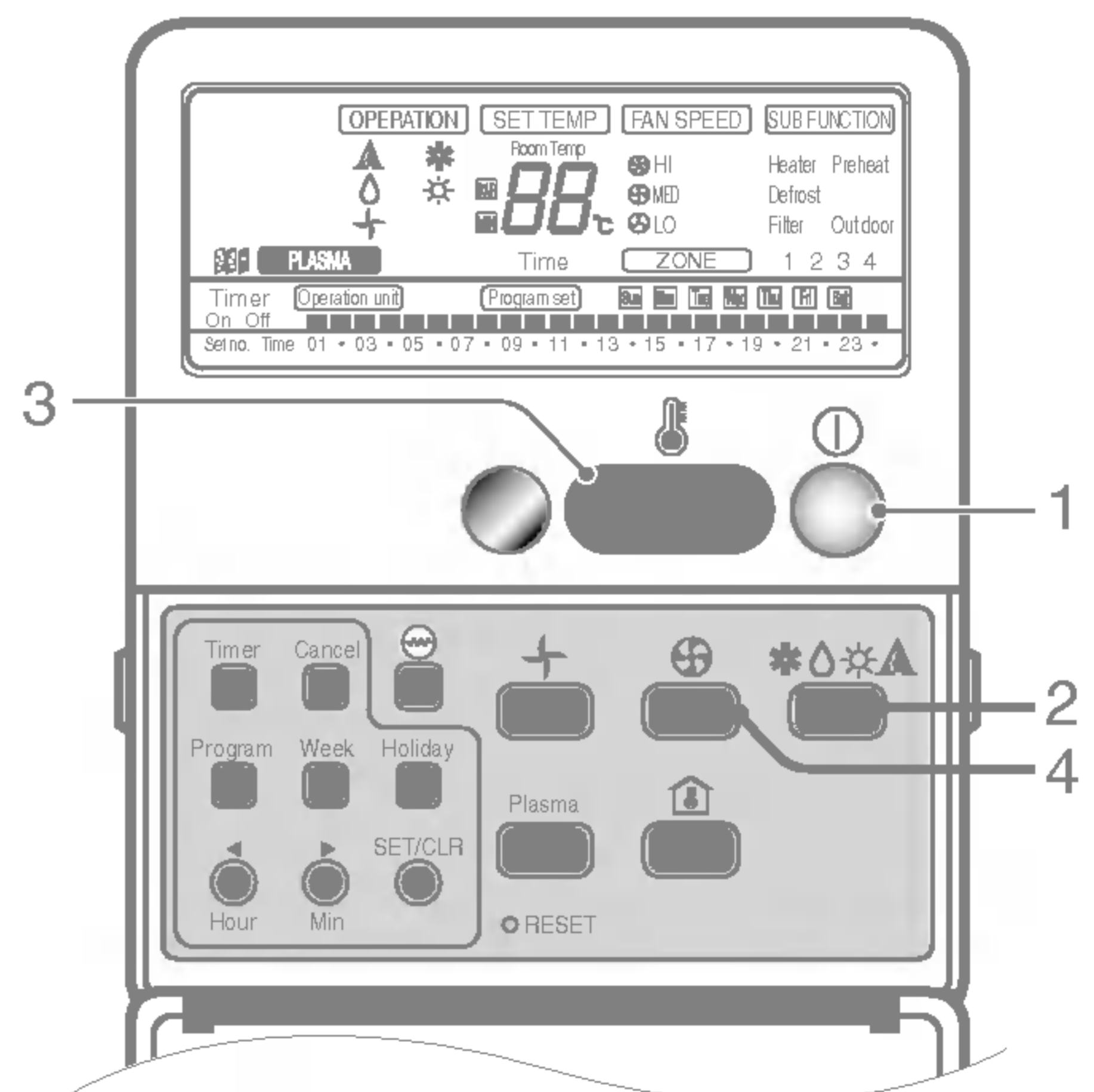

Cooling Operation Mode

1 Press the On/Off Button.

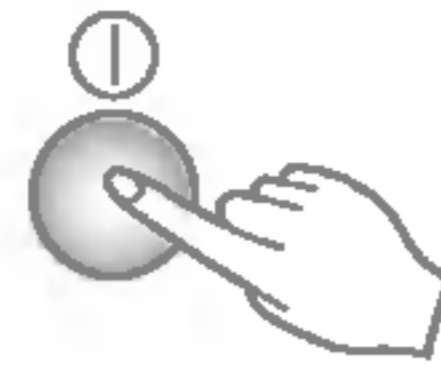

2 Select Cooling Operation.
Press the Operation Mode Selection Button.
Each time the button is pressed, the operation mode is shifted in the arrow direction.

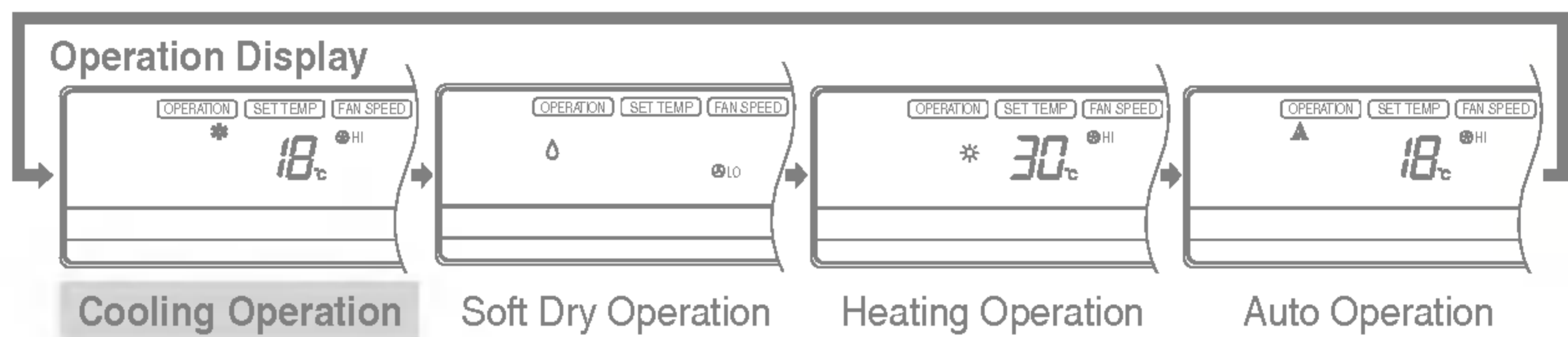

3 Set the temperature lower than the room temperature.

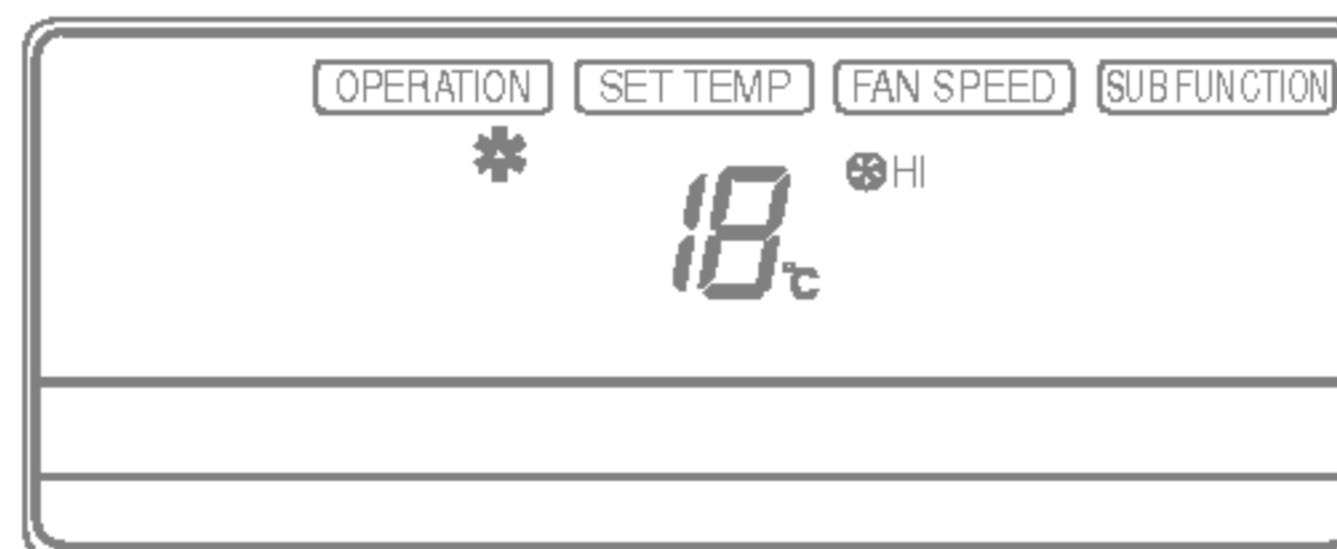

The temperature can be set within a range of 18°C ~ 30°C by 1°C.

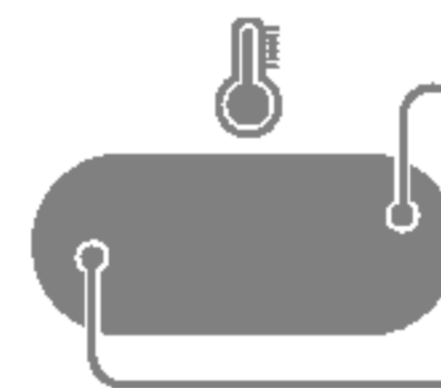

To raise the Temperature.

To lower the Temperature.

4 Set the fan speed.

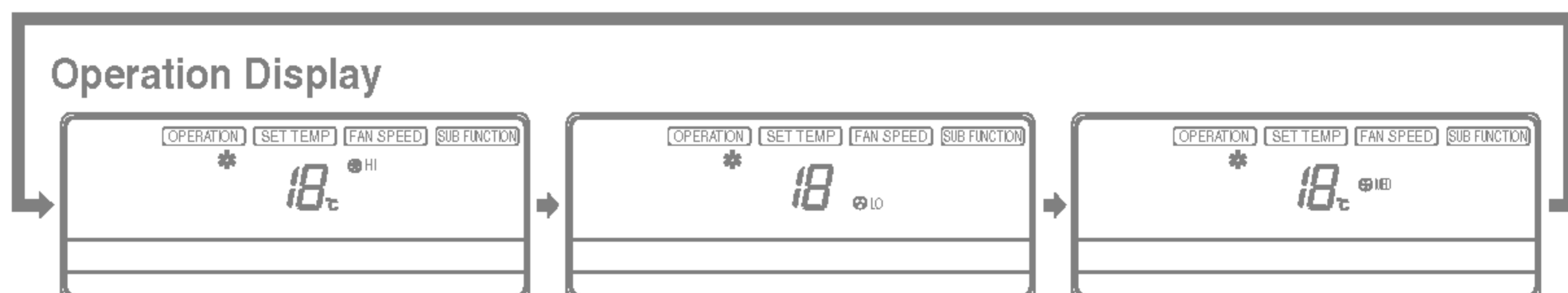

- Select the fan speed in three steps- high, low, medium.
- The display shows high fan speed.
- Each time the button is pressed, the fan speed mode is shifted.

Soft Dry Operation Mode

This mode dehumidifies without overcooling.

1 Press the On/Off Button.



2 Select Soft Dry Operation.

Press the operation Mode Selection Button.

Each time the button is pressed, the operation mode is shifted in the arrow direction.

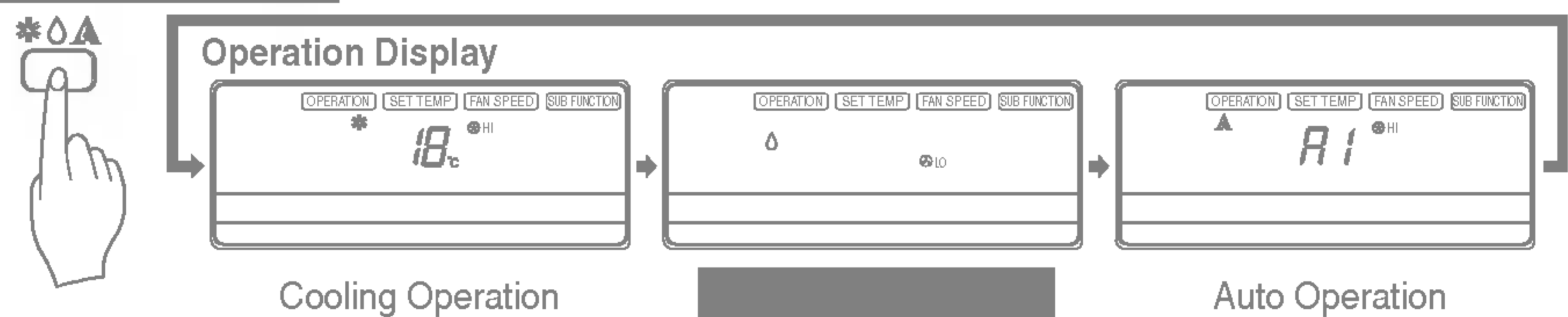
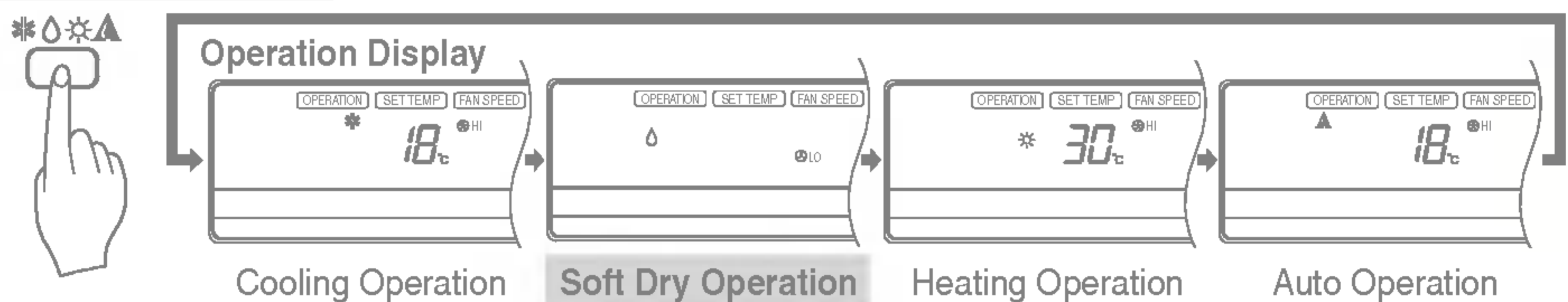

3 During Soft Dry Operation.

- The indoor fan speed is automatically set to the low, so the shift of the indoor fan speed is impossible because it's already being set to the best speed for Dry Operation by Micom Control.

Heating Operation Mode

1 Press the On/Off Button.



2 Select Heating Operation.

Press the Operation Mode Selection Button.
Each time the button is pressed, the operation mode is shifted in the arrow direction.

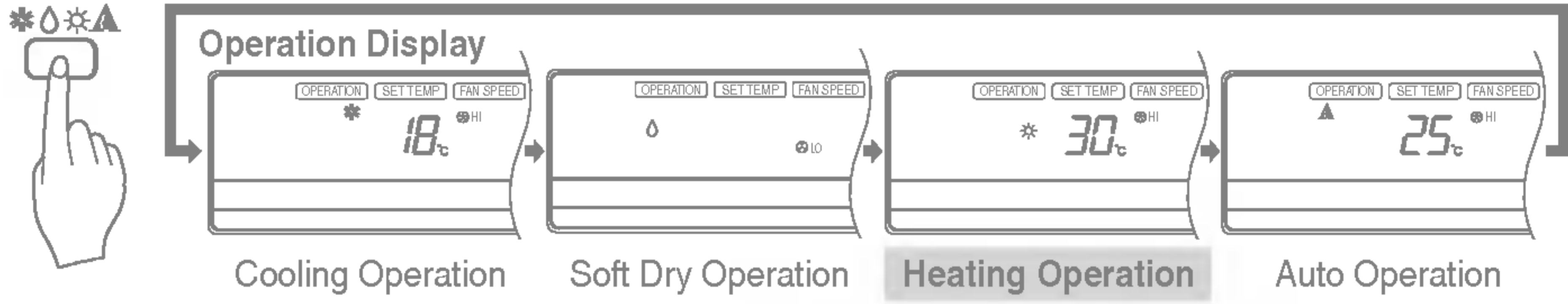

3 Set the temperature.

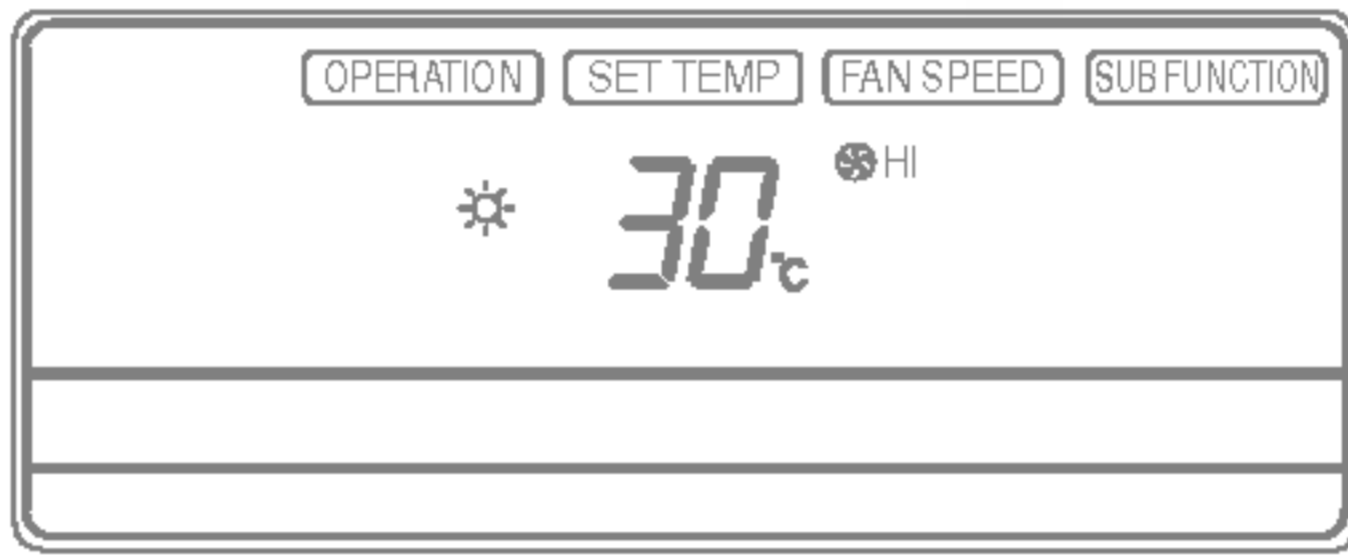

• The temperature can be set within a range of 16°C~30°C by 1°C.

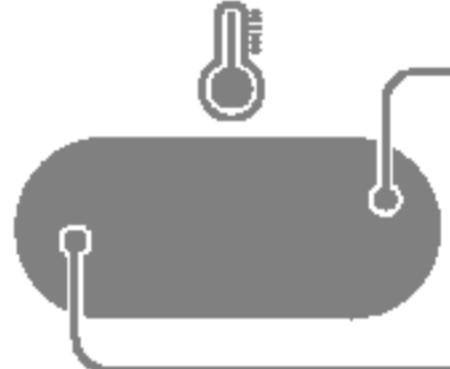

To raise the Temperature.

To lower the Temperature.

4 Set the fan speed.

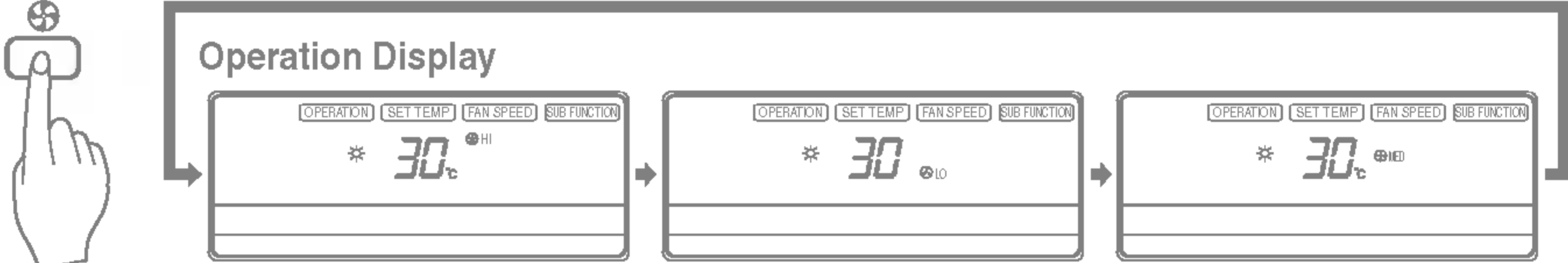

- Select the fan speed in three steps - high, low, medium.
- The display shows high fan speed
- Each time the button is pressed, the fan speed mode is shifted.

5 This air-conditioner is set to the hot start control in order not to discharge the cold air during the heating operation. This time, the remote controller indicates 'Preheat'.

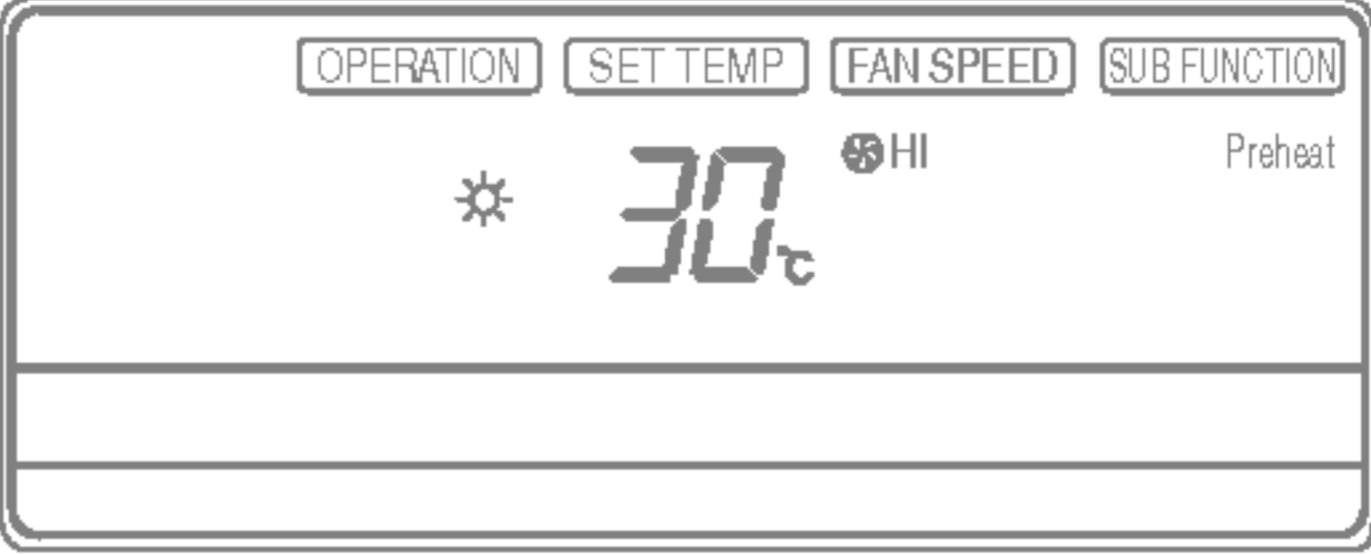

6 If the outdoor temperature is too low during the heating operation, this air-conditioner is set to the defrosting operation and the remote controller indicates 'Defrost'.

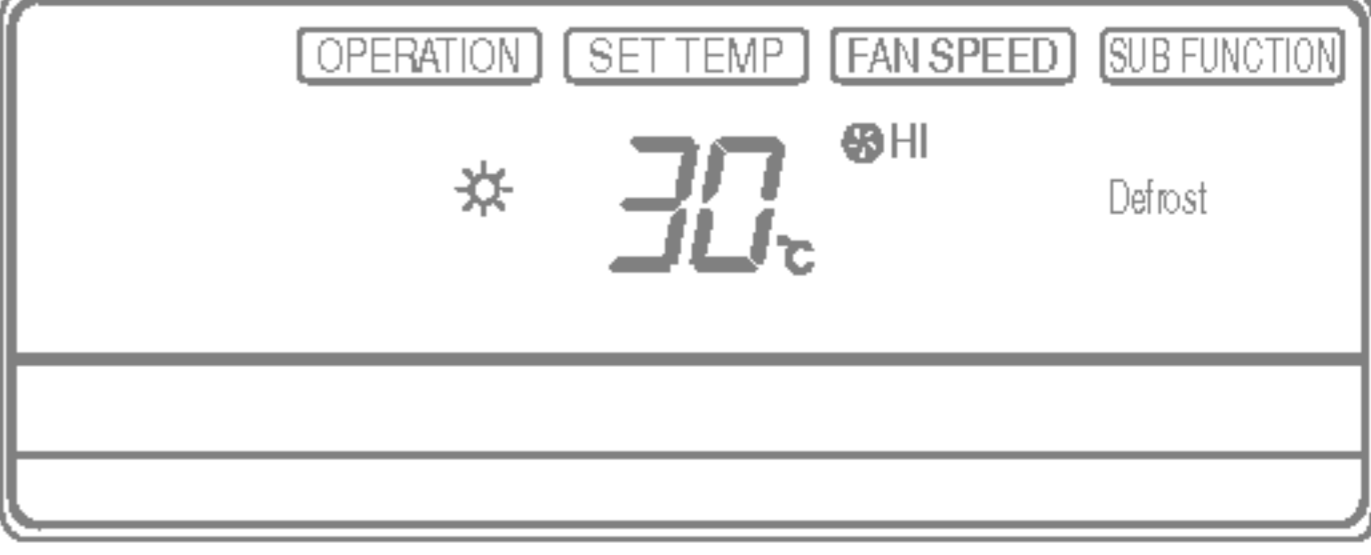

Auto Operation Mode

1 Press the On/Off Button.

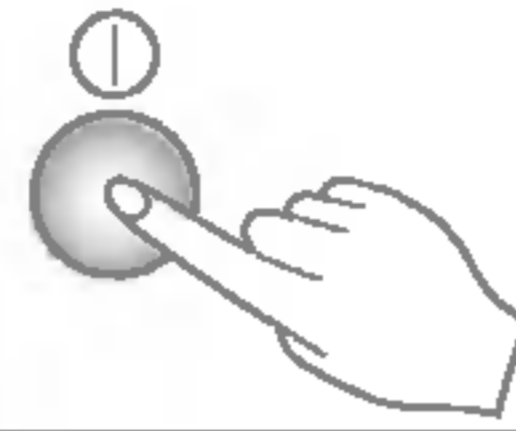

2 To select **Auto Operation**, press the Operation Mode Selection button. Each time the button is pressed, the operation mode is shifted in the direction of the arrow.

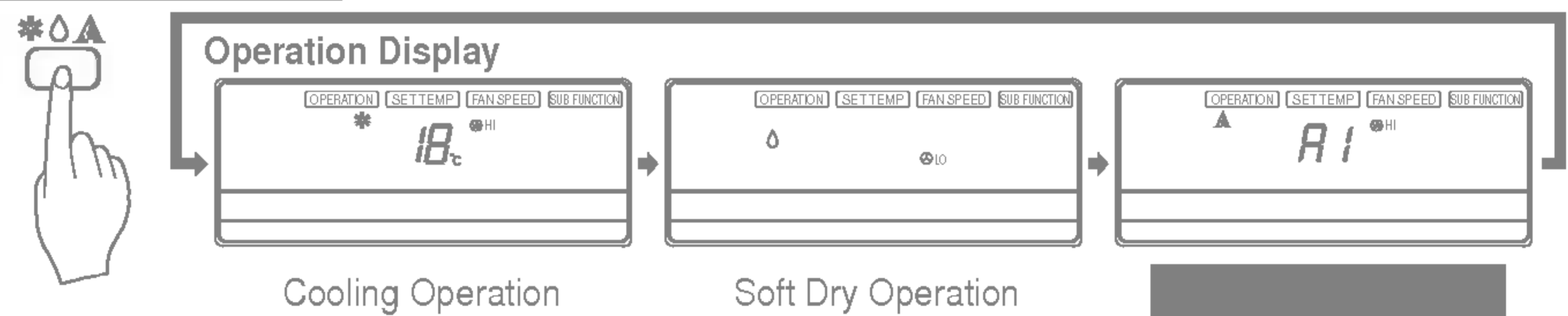
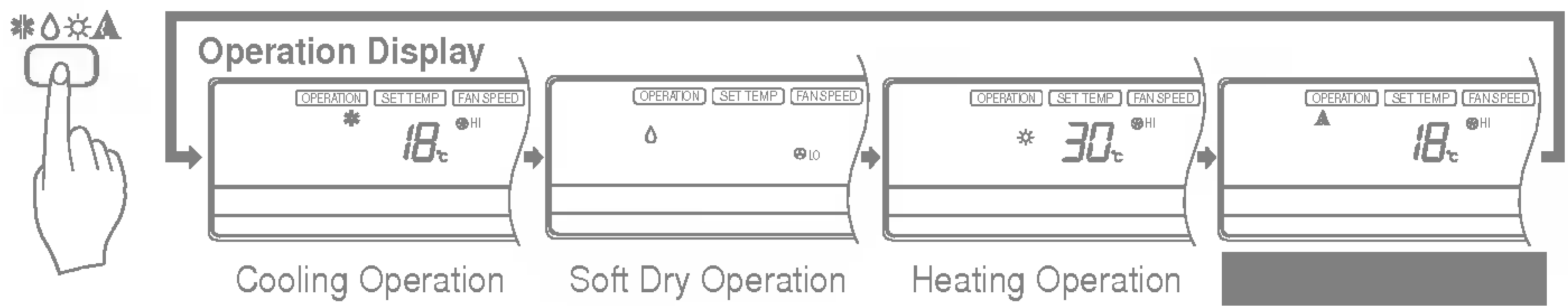

3 Set the temperature lower than the room temperature. The temperature can be set within a range of 18°C ~ 30°C by 1°C.

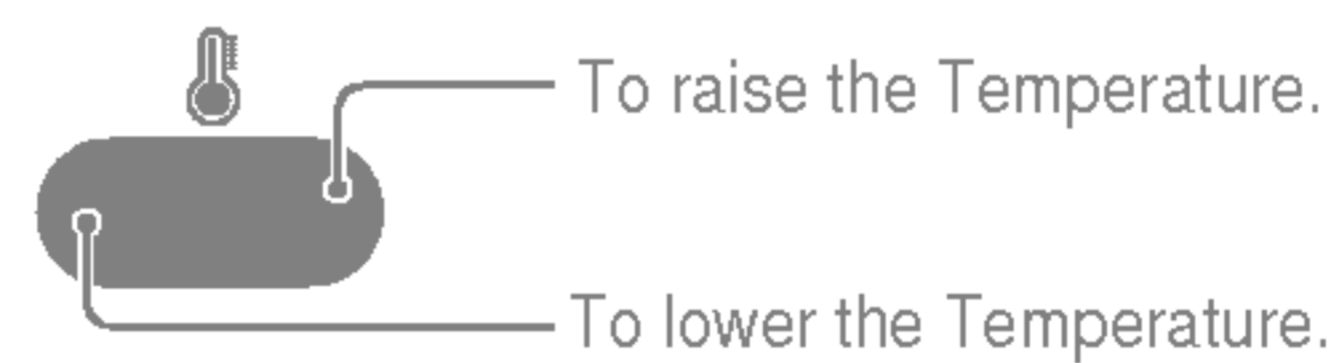
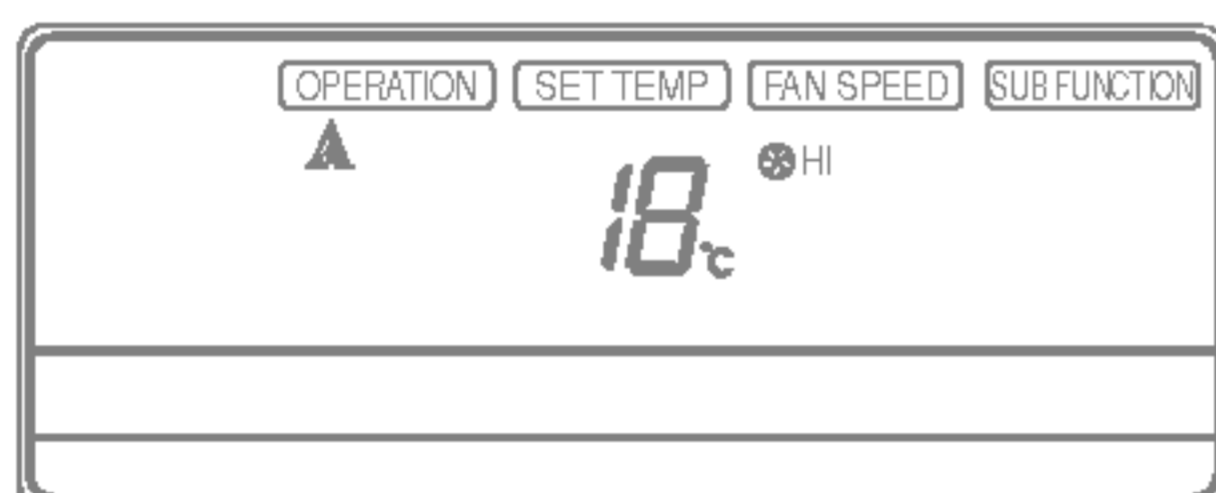

Set the temperature upper or lower than the standard temperature. The temperature can be set within a range of -2 ~ 2 by 1 level.

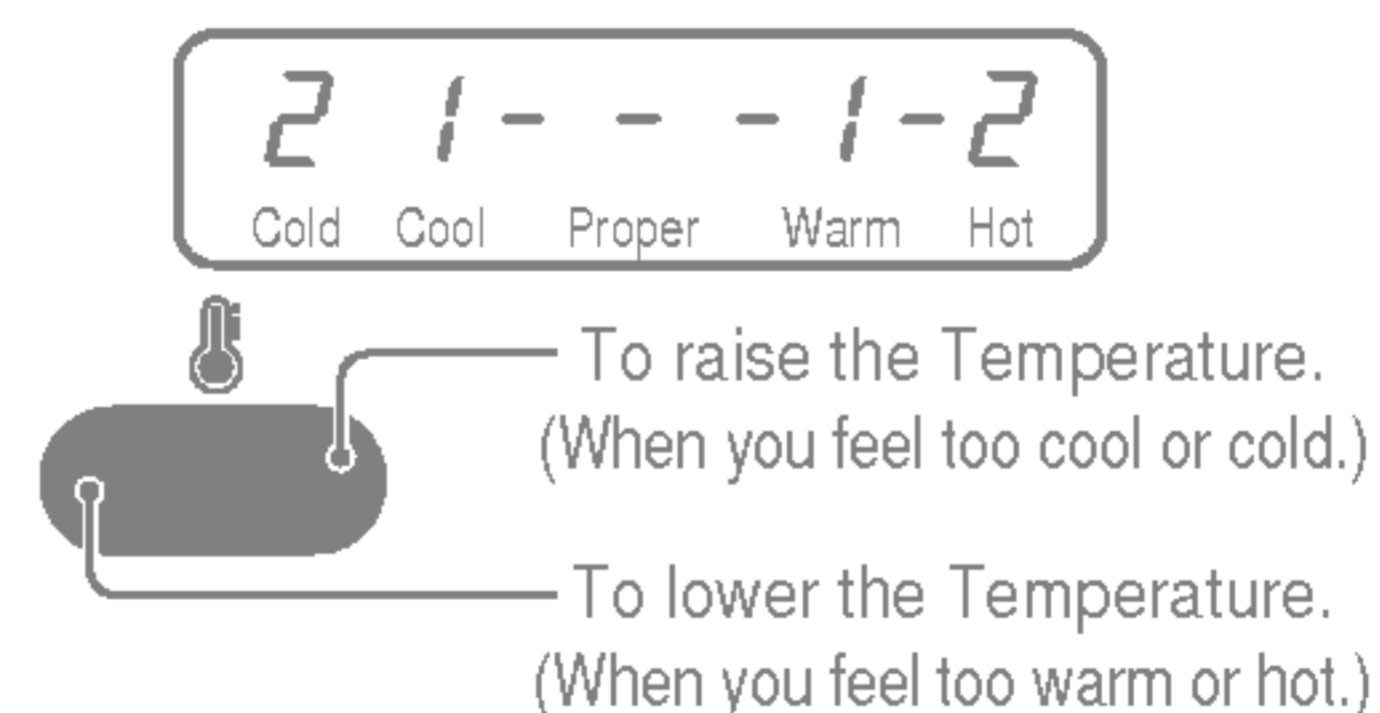
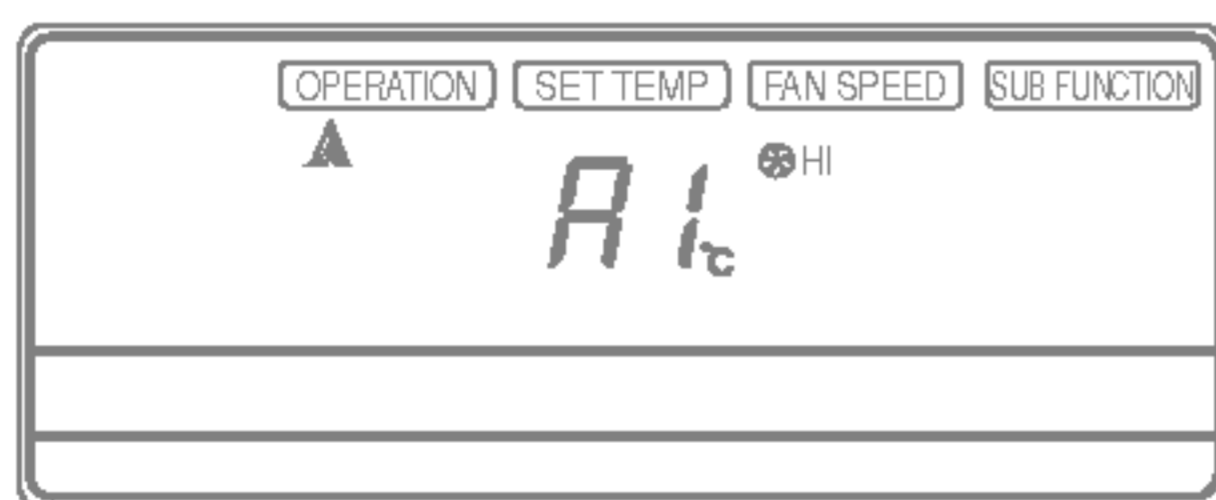

(This indication will be shifted to the initial Auto Mode Display state after 4 seconds.)

During Auto Operation:

- You cannot switch the indoor fan speed. It has already been set by the Fuzzy rule.
- If the system is not operating as desired, manually switch to another mode. The system will not automatically switch from the cooling mode to the heating mode, or from heating to cooling, it must be done by manually resetting.

FAN Operation

1 Press the On/Off Button.



2 Press FAN Operation Button.



3 Each time Indoor Fan Speed button is pressed, the fan speed mode is shifted in the arrow direction.

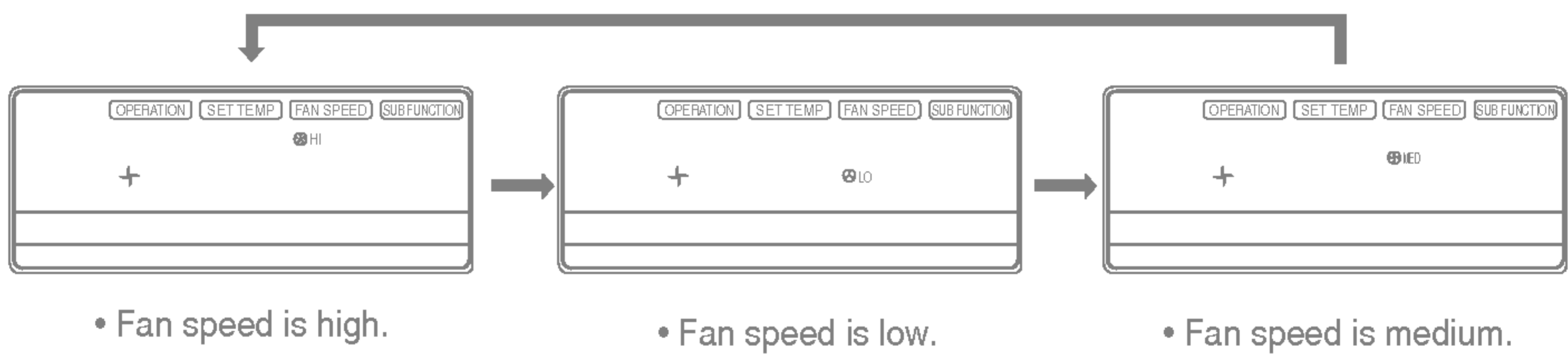

Child Lock Function

This is the Function that any children cannot used to the air-conditioner.

Operation procedure

1. To set the Child-Lock Function

Press the Timer button and Minute Set button for three seconds. Then the operation mode shift to child lock mode and it is displayed 'CL' in the operation display.

When you press any button in this time, the remote controller is not converted to any selected mode and the 'CL' is displayed in the remote controller for about three seconds. But the Room Temperature function is operated in spite of child lock mode.

2. To cancel the Child-Lock Function

Press the Timer button and Minute Set button for three seconds. Then the child-lock mode is cancelled and the preselected mode is displayed in the remote controller.

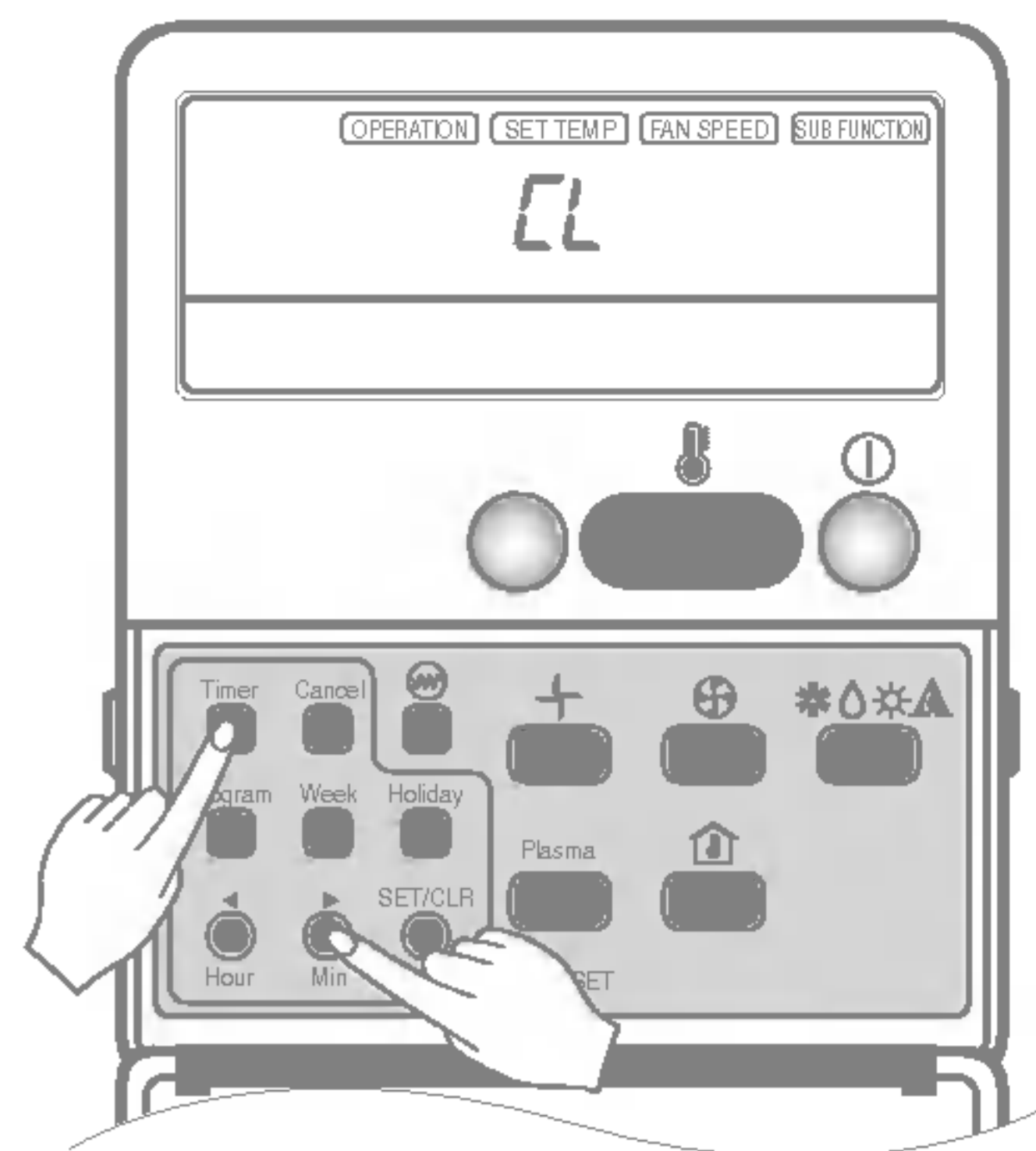

Operation Details

• Cooling Operation Mode

When the room temperature is higher than the set temperature, it operates in cooling mode at the set temperature, the set fan speed, and then it will be in automatically turn off when the room temperature reaches the set temperature +0.5°C.

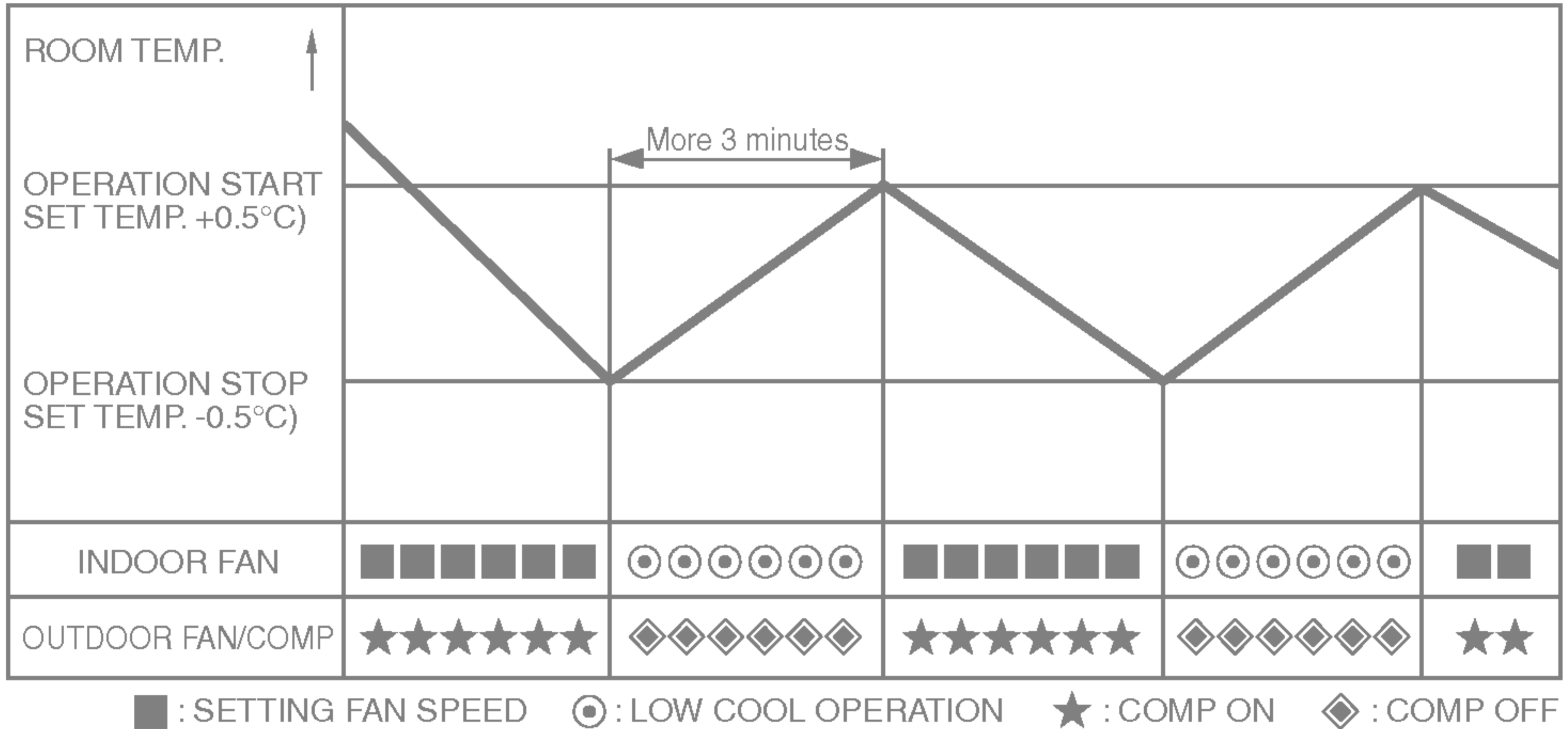

Helpful information

Airflow speed and cooling capacity.
 The cooling capacity indicated in the specification is the value when the fan speed is set to high, and the capacity will be lower at low or medium fan speed.
 High fan speed is recommended when you wish to cool the room quickly.

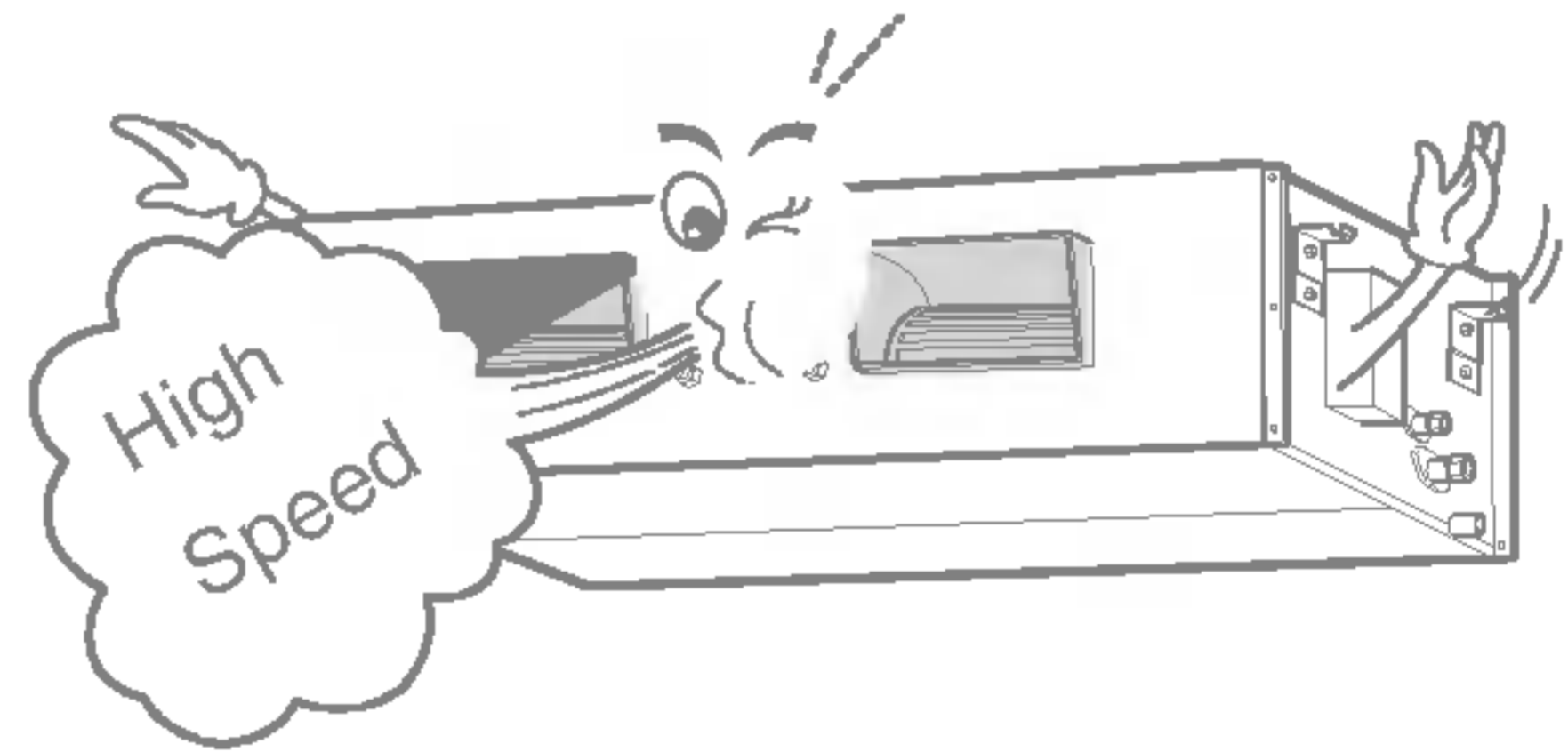

Self-Diagnosis Function

'CH' will flash in the remote controller display when a problem occurs. Then please contact your dealer.



CAUTION: Before performing any maintenance, turn off the main power to the system.

Grille, Case, and Remote Control

- Turn the system off before cleaning. To clean, wipe with a soft, dry cloth. Do not use bleach or abrasives.

Supply power must be disconnected before cleaning the indoor unit.

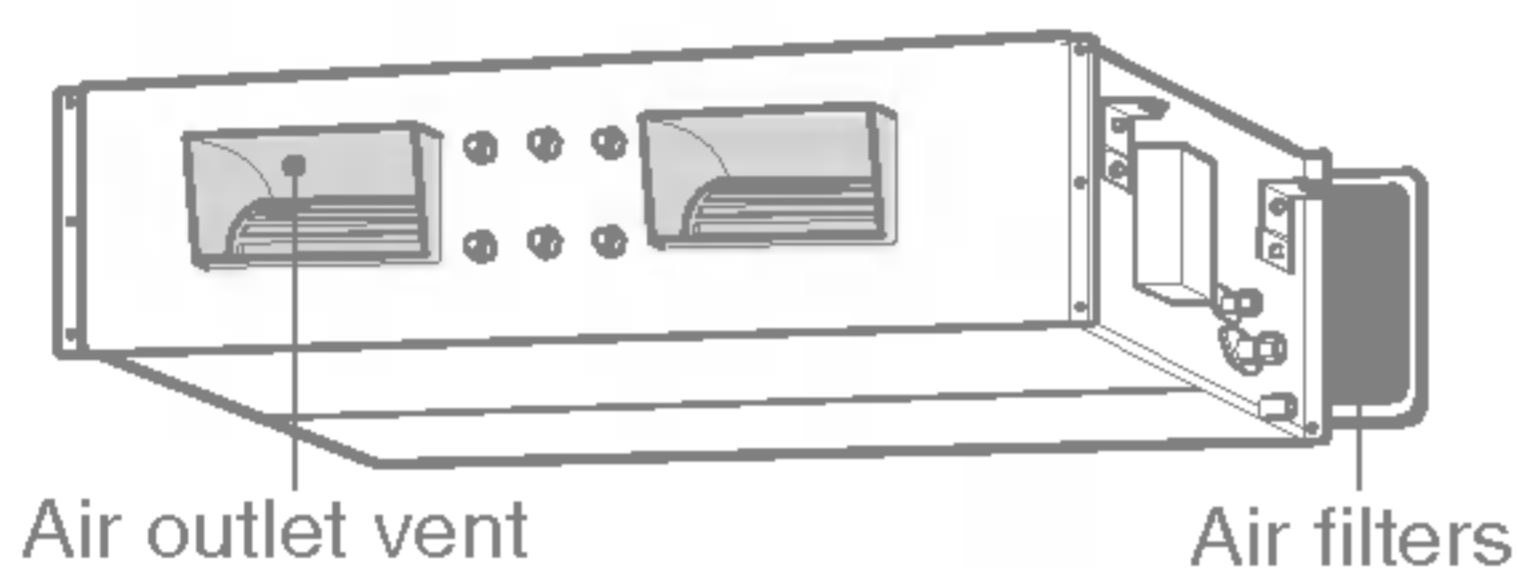

Air Filter

The air filters behind Indoor unit (the suction side) should be checked and cleaned once every 2 weeks or more often if necessary.

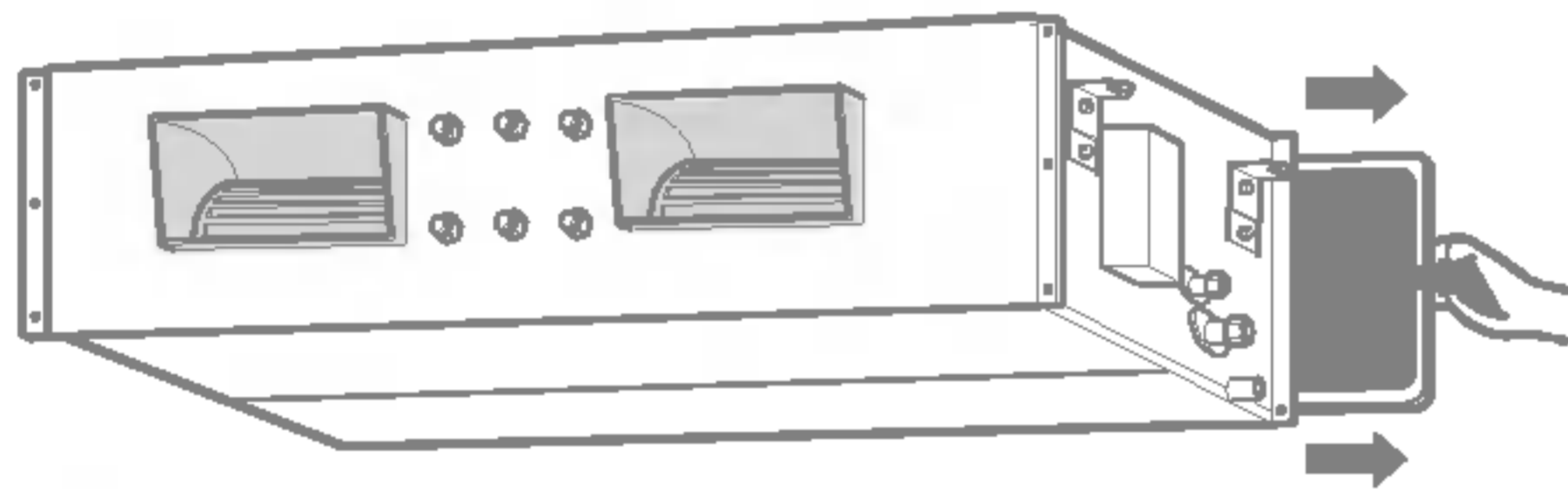

- Never use any of the followings:

- Water hotter than 40°C
Could cause deformation and/or discoloration.
- Volatile substances
Could damage the surfaces of the air conditioner.



1. Clean the filter with a vacuum or warm, soapy water.
 - If very dirty, wash with a solution of detergent in lukewarm water.
 - If hot water (50°C or more) is used, filter may be deformed.
2. After washing with water, dry well in the shade.
3. Re-install the air filter.

Right time.

When it is time to be used

- 1 Operate the air conditioner on FAN operation mode (Refer to page 19) for 2 to 3 hours.
 - This will dry out the internal parts.
- 2 Turn off the circuit breaker.

CAUTION

Turn off the circuit breaker when the air conditioner is not going to be used for a long time. Dirt may collect and may cause a fire.

When the conditioner is not used

- Check that the air inlet and outlet of the indoor/outdoor unit are not blocked.

Helpful information

The air filters and your electric bill.
If the air filters become clogged with dust, the cooling capacity will drop, and 6% of the electricity used to operate the air conditioner will be wasted.

Do not overcool the room.

This is not good for the health and wastes electricity.

Clean the air filter regularly.

Blockages in the air filter reduce the airflow and lower cooling and dehumidifying effects. Clean at least once every two weeks.

Keep blinds or curtains

Do not let direct sunshine enter the room when the air conditioner is in operation.

Ventilate the room

Since windows are kept closed, it is a good idea to open them and ventilate the room now and then.

Make sure that the doors

Avoid opening doors and windows as much as possible to keep the cool air in the room.

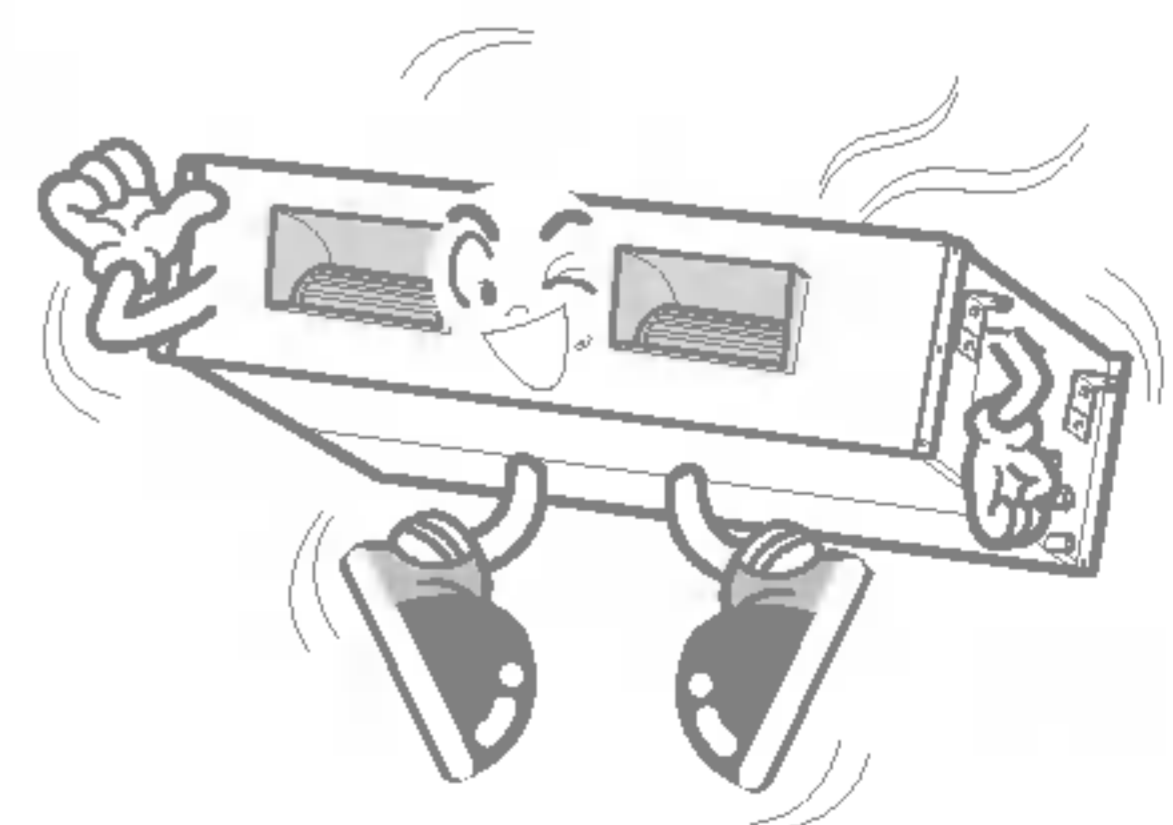



Troubleshooting Tips! Save time and money!

Check the following points before requesting repairs or service.... If the malfunction persists, please contact your dealer.

<p>The air conditioner does not operate.</p> <ul style="list-style-type: none"> • Have you made a mistake in timer operation? • Has the fuse blown or has the circuit breaker been tripped? 	<p>The room has a peculiar odor.</p> <ul style="list-style-type: none"> • Check that this is not a damp smell exuded by the walls, carpet, furniture or cloth items in the room. 	<p>It seems that condensation is dripping.</p> <ul style="list-style-type: none"> • Condensation occurs when the airflow from the air conditioner cools the warm room air. 	<p>Air conditioner does not operate for about 30 minutes.</p> <ul style="list-style-type: none"> • This is the protector of the mechanism. • Wait about three minutes and operation will begin.
<p>Does not cool or heat effectively.</p> <ul style="list-style-type: none"> • Is the air filter dirty? See air filter cleaning instructions. • The room may have been very hot when the room air conditioner was first turned on. Allow time for it to cool down. • Has the setting temperature been set incorrectly? • Are the indoor unit's air inlet or outlet vents obstructed? 	<p>The air conditioner operation is noisy.</p> <ul style="list-style-type: none"> • For a noise that sounds like water flowing. <ul style="list-style-type: none"> -This is the sound of freon flowing inside the air conditioner unit. • For a noise that sounds like the compressed air releasing into atmosphere. <ul style="list-style-type: none"> -This is the sound of the dehumidifying water being processed inside the air conditioning unit. 	<p>Click sound is heard.</p> <ul style="list-style-type: none"> • This sound is generated by the expansion/contraction of the inlet grille, etc. due to changes of temperature. 	<p>Remote control display is fainter than normal.</p> <ul style="list-style-type: none"> • Has the circuit breaker been tripped?

