

# Table of Contents

<b>Installation and Connection</b>	Safety Precautions	
	Accessories	
	Before Connecting to the PC	
	Name and Function of the Parts	
	Connecting to External Devices	
	Connecting to your PC	
Watching Video/DVD		
<b>Input Selection and Tracking</b>	Selecting and Adjusting the Screen	
	Name of the Buttons in the screen Adjustment Unit	
	OSD (On Screen Display) Screen Tracking Order	
	When Connected to your PC	
	Adjusting Screen Colour	
	Adjusting the audio function	
	Adjusting Screen CLOCK/PHASE and Position	
	Adjusting PIP Mode Functions	
	Selecting the Options	
	When Watching Video/DVD	
Adjusting Screen Colour		
Adjusting the audio function		
Adjusting PIP Mode Functions		
Selecting the Options		
<b>Miscellaneous</b>	Troubleshooting	
	Product Specifications	



is a trademark of SRS Labs, Inc.  
technology is incorporated under license from SRS Labs, Inc.

Please read these safety precautions carefully before using the monitor.

 **Warning** If you ignore the warning message, you may be seriously injured or there is a possibility of accident or death.

 **Caution** If you ignore the caution message, you may be slightly injured or the product may be damaged

---

## Precautions in installing the Monitor

### Warning

- **Keep away from heat sources like electrical heaters.**
  - Electrical shock, fire, malfunction or deformation may occur.
- **Keep the packing anti-moisture material or vinyl packing out of the reach of children.**
  - Anti-moisture material is harmful if swallowed. If swallowed by mistake, force the patient to vomit and visit the nearest hospital. Additionally, vinyl packing can cause suffocation. Keep it out of the reach of children.
- **Do not put heavy objects on the monitor or sit upon it.**
  - If the monitor collapses or is dropped, you may be injured. Children must pay particular attention.
- **Do not leave the power or signal cable unattended on the pathway.**
  - The passerby can falter, which can cause electrical shock, fire, product breakdown or injury.
- **Install the monitor in a neat and dry place.**
  - Dust or moisture can cause electrical shock, fire or product damage.
- **If you can smell smoke or other odors or hear a strange sound unplug the power cord and contact the service center.**
  - If you continue to use without taking proper measures, electrical shock or fire can occur.
- **If you dropped the monitor or the case is broken, turn off the monitor and unplug the power cord.**
  - If you continue to use without taking proper measures, electrical shock or fire can occur. Contact the service center.
- **Do not drop metallic objects such as coins, hair pins, chopsticks or wire into the monitor, or inflammable objects such as paper and matches. Children must pay particular attention.**
  - Electrical shock, fire or injury can occur. If a foreign object is dropped into the monitor, unplug the power cord and contact the service center.

### Caution

- **Make sure the monitor ventilation hole is not blocked. Install the monitor in a suitably wide place (more than 10cm from the wall)**
    - If you install the monitor too close to the wall, it may be deformed or fire can break out due to internal heat.
  - **Do not block the ventilation hole of the monitor by a tablecloth or curtain.**
    - The monitor can be deformed or fire can break out due to overheating inside the monitor.
  - **Install the monitor on a flat and stable place that has no risk of dropping the monitor.**
    - If the monitor is dropped, you may be injured or the monitor may be broken.
  - **Install the monitor where no EMI occurs.**
  - **Keep the monitor away from direct sunlight.**
    - The monitor can be damaged.
- 



---

## Electrical Power Related Precautions

### Warning

- **Make sure to connect the power cable to the grounded current.**
  - You may be electrocuted or injured.
- **Use the rated voltage only.**
  - The monitor can be damaged, or you may be electrocuted.
- **During a thunder or lightning storm, unplug the power cable or signal cable.**
  - You may be electrocuted or a fire can break out.
- **Do not connect several extension cords, electrical appliances or electrical heaters to a single outlet. Use a power bar with a grounding terminal designed for exclusive use with the computer.**
  - A fire can break out due to overheating.
- **Do not touch the power plug with wet hands. Additionally, if the cord pin is wet or covered with dust, dry the power plug completely or wipe dust off.**
  - You may be electrocuted due to excess moisture.
- **If you don't intend to use the monitor for a long time, unplug the power cable from the monitor.**
  - Covering dust can cause a fire, or insulation deterioration can cause electric leakage, electric shock or fire.
- **Fix the power cable completely.**
  - If the power cable is not fixed completely, a fire can break out.
- **Hold the plug when pulling out the power cable. Do not bend the power cord with excessive force or put heavy objects on the power cord.**
  - The power line can be damaged, which may cause electric shock or fire.
- **Do not insert a conductor (like a metal chopstick) into one end of the power cable while the other end is connected to the input terminal on the wall. Additionally, do not touch the power cable right after plugging into the wall input terminal.**
  - You may be electrocuted.

### Caution

- **Do not unplug the power cord while the monitor is in use.**
  - Electrical shock can damage the monitor.

---

## Precautions in Moving the Monitor

### Warning

- **Make sure to turn off the monitor.**
    - You may be electrocuted or the monitor can be damaged.
  - **Make sure to remove all cables before moving the monitor.**
    - You may be electrocuted or the monitor can be damaged.
- 

## Caution

- **Do not shock the monitor when moving it.**
    - You may be electrocuted or the monitor can be damaged
  - **Do not dispose the product-packing box. Use it when you move.**
  - **Make the panel face forward and hold it with both hands to move.**
    - If you drop the monitor, the damaged monitor can cause electric shock or fire. Contact with the service center for repair.
- 

## Precautions in Using the Monitor

### Warning

- **Do not disassemble, repair or modify the monitor at your own discretion.**
  - Fire or electric shock accident can occur.
  - Contact the service center for check, calibration or repair.
- **Do not spray water on the monitor or scrub with an inflammable substance (thinner or benzene). Fire or electric shock accident can occur**
- **Keep the monitor away from water.**
  - Fire or electric shock accident can occur.

### Caution

- **Do not put or store inflammable substances near the monitor.**
    - There is a danger of explosion or fire due careless handling of the inflammable substances.
  - **When cleaning the brown tube surface, unplug the power cord and scrub with soft cloth to prevent scratching. Do not clean with a wet cloth.**
    - The water can sink into the monitor, which can cause electric shock or serious malfunction.
  - **Take a rest from time to time to protect your vision.**
  - **Keep the monitor clean at all times.**
  - **Take a comfortable and natural position when working with a monitor to relax the muscles.**
  - **Take a regular break when working with a monitor for a long time.**
  - **Do not press strongly upon the panel with a hand or sharp object such as nail, pencil or pen, or make a scratch on it.**
  - **Keep the proper distance from the monitor.**
    - Your vision may be impaired if you look at the monitor too closely.
  - **Set the appropriate resolution and clock by referring to the User's Manual.**
    - Your vision can be impaired.
  - **Use authorized detergent only when cleaning the monitor. (Do not use benzene, thinner or alcohol.)**
    - Monitor can be deformed.
- 

## On Disposal

- The fluorescent lamp used in this product contains a small amount of mercury.
  - Do not dispose of this product with general household waste.  
Disposal of this product must be carried out in accordance to the regulations of your local authority.
- 



Please check the accessories in the product package.  
\* The monitor and the accessories can be different from the figures shown here.

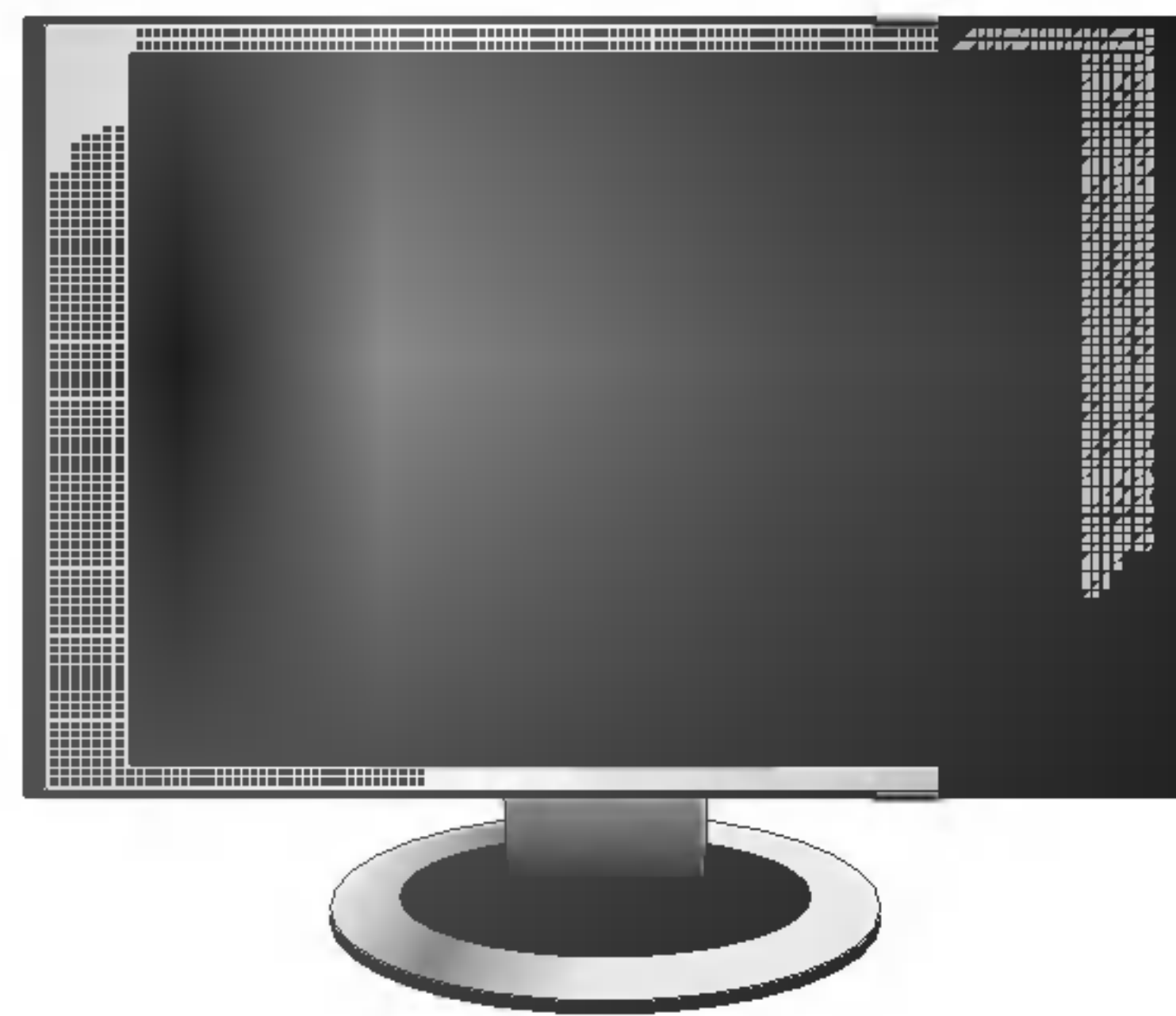

Monitor



Remote Controller/Batteries (AAA x 2)



Cable Cap

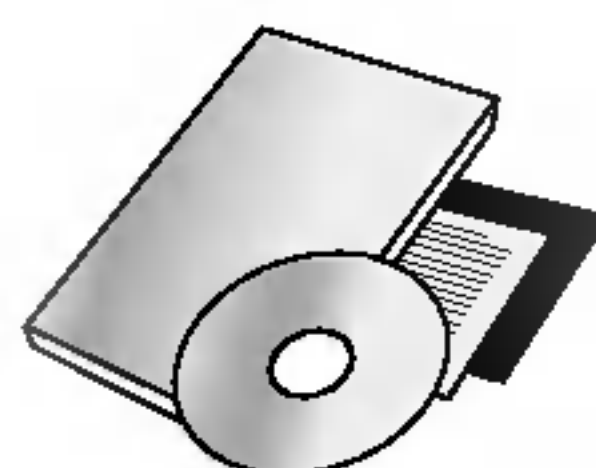

User's Guide  
/Cards/Drive



15-pin D-Sub Signal  
Cable

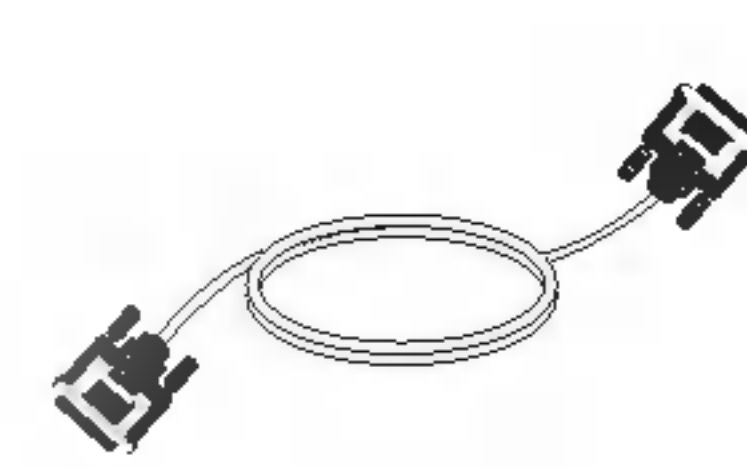

DVI-D Signal  
Cable

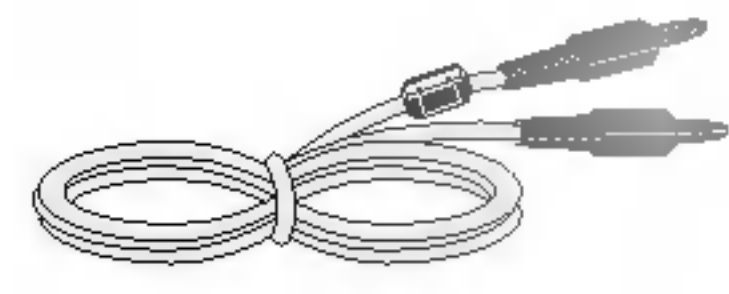

Audio Cable (PC)

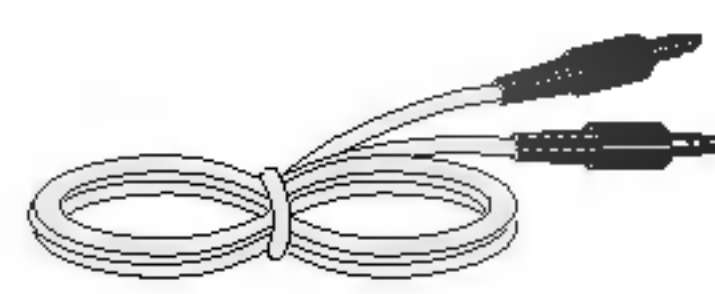

MIC Cable



Power Cord

### Inserting batteries into remote controller.

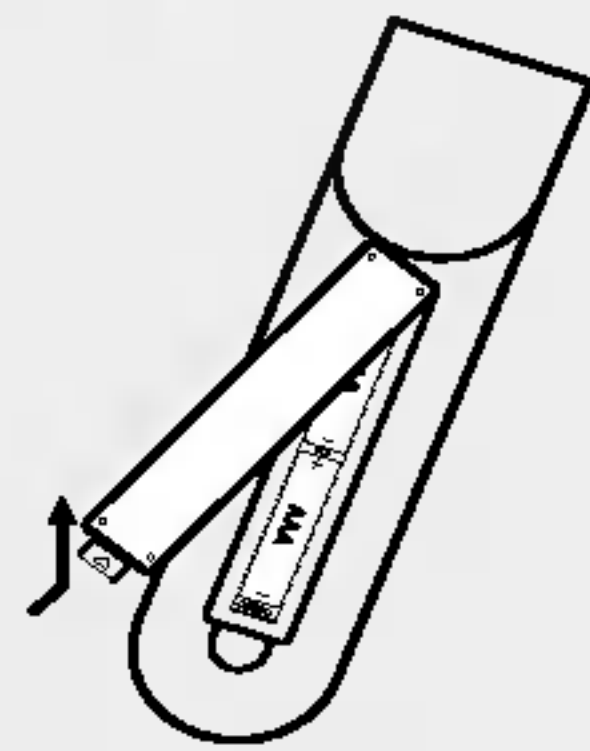

1. Take out the battery cap.
2. Insert the battery with correct polarity (+/-).
3. Close the battery cap.
  - You can use a remote controller 7 meter distance and 30 degree (left/right) within the receiving unit scope.
  - Dispose of used batteries in the recycle bin to prevent environmental pollution.

- Before setting up the monitor, ensure that the power to the monitor, the computer system, and other attached devices is turned off.

## Unfolding the stand base

- 1 Place the monitor with its front facing downward on a cushion or soft cloth.

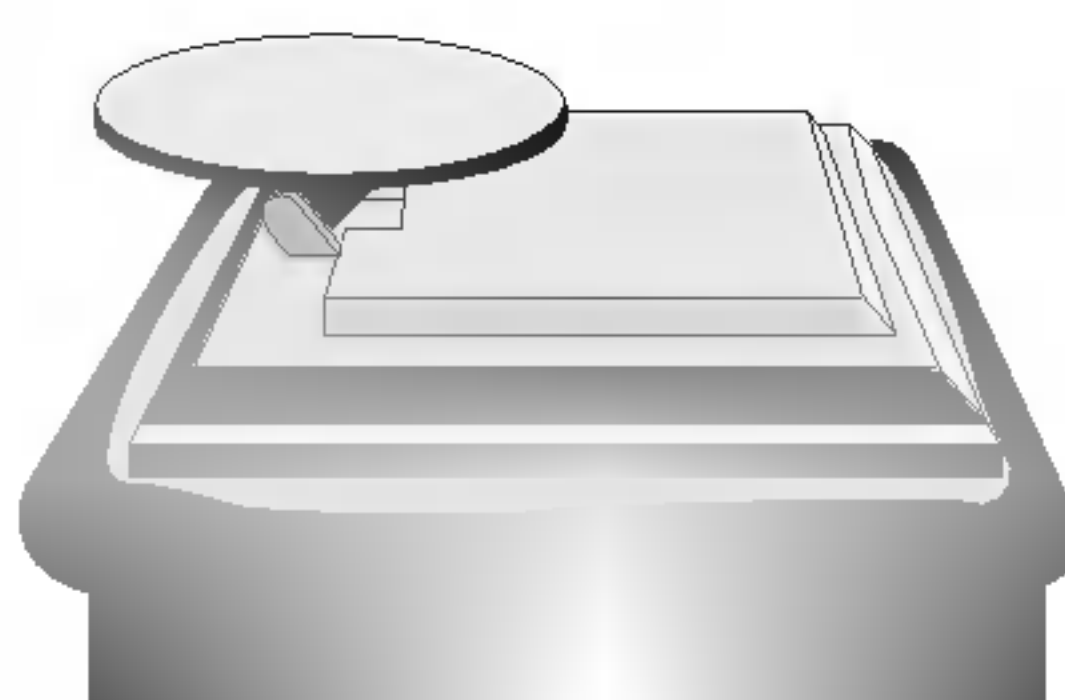

- 2 Hold down the release button inside the stand and strongly pull out the stand with your two hands.

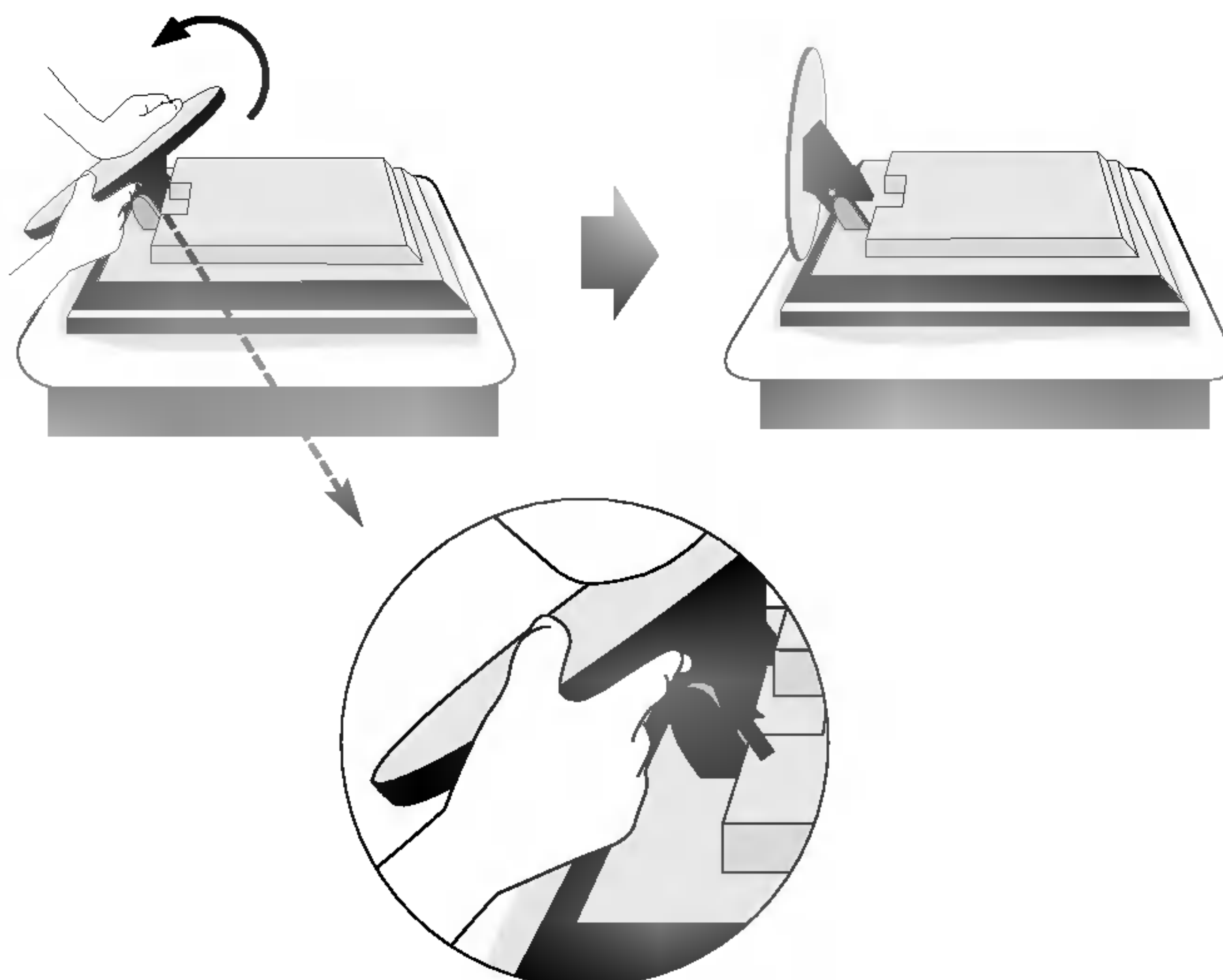

The stand won't move if you don't press release button.



■■■ To arrange the cables

- 1 First, pull out the back cap attached to the rear of the monitor to detach, as shown.

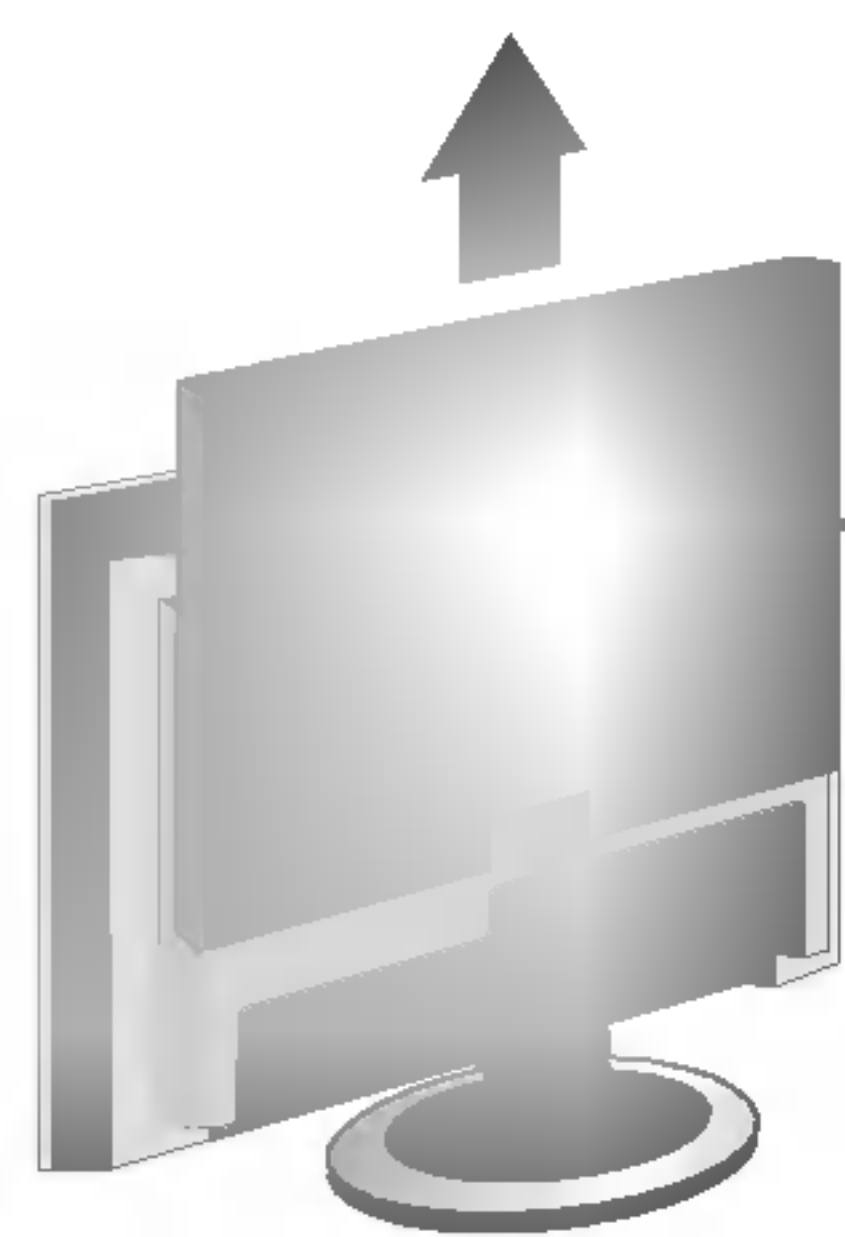

Back Cap

- Open the back cap before you install the monitor.

- 2 Connect the signal input cable and the audio cable to use in order to arrange the power cord, D-sub cable in the cable holder as shown in the following figure.

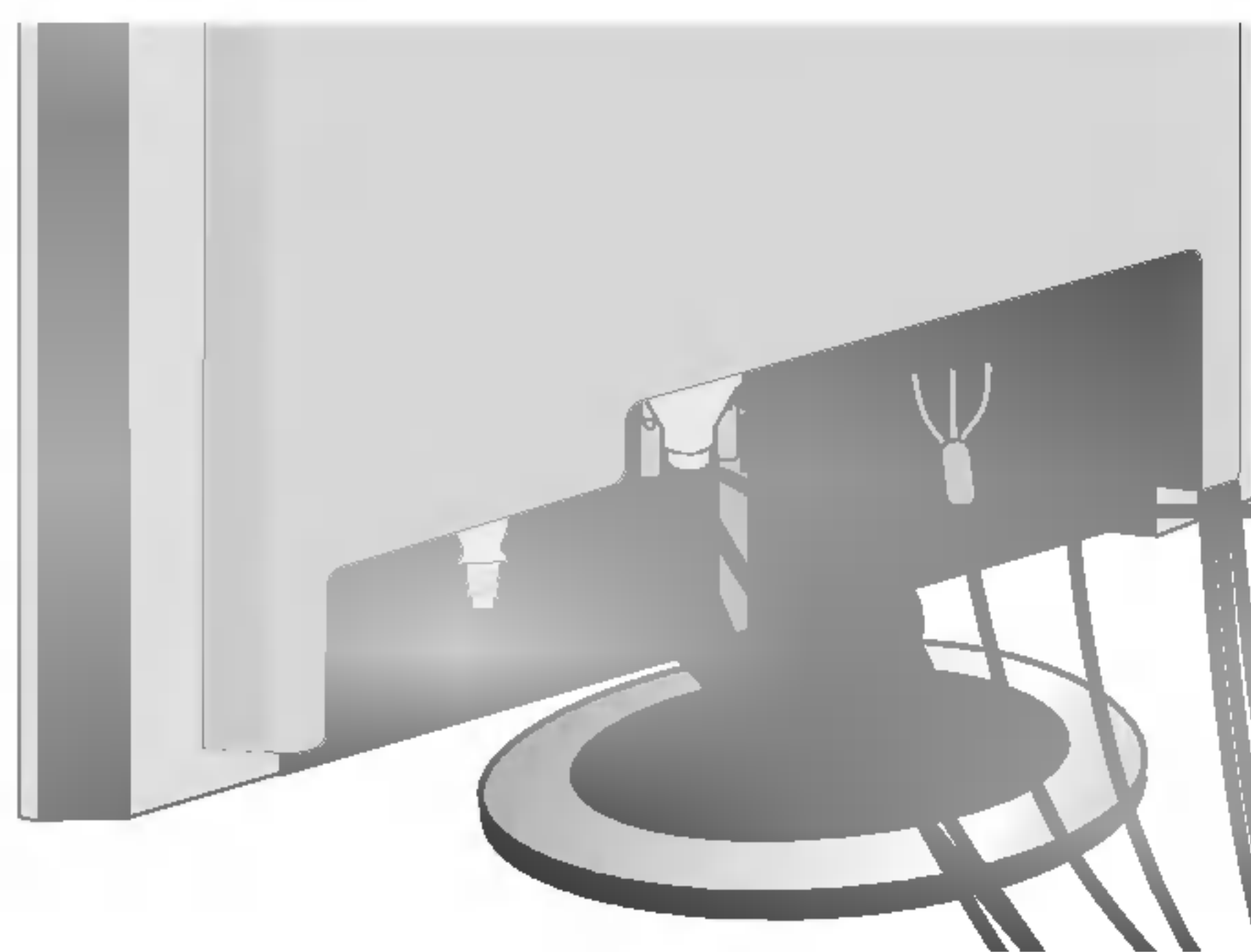

Cable Holder

- 3 Push the cable cap according to the steps shown in the following figure.

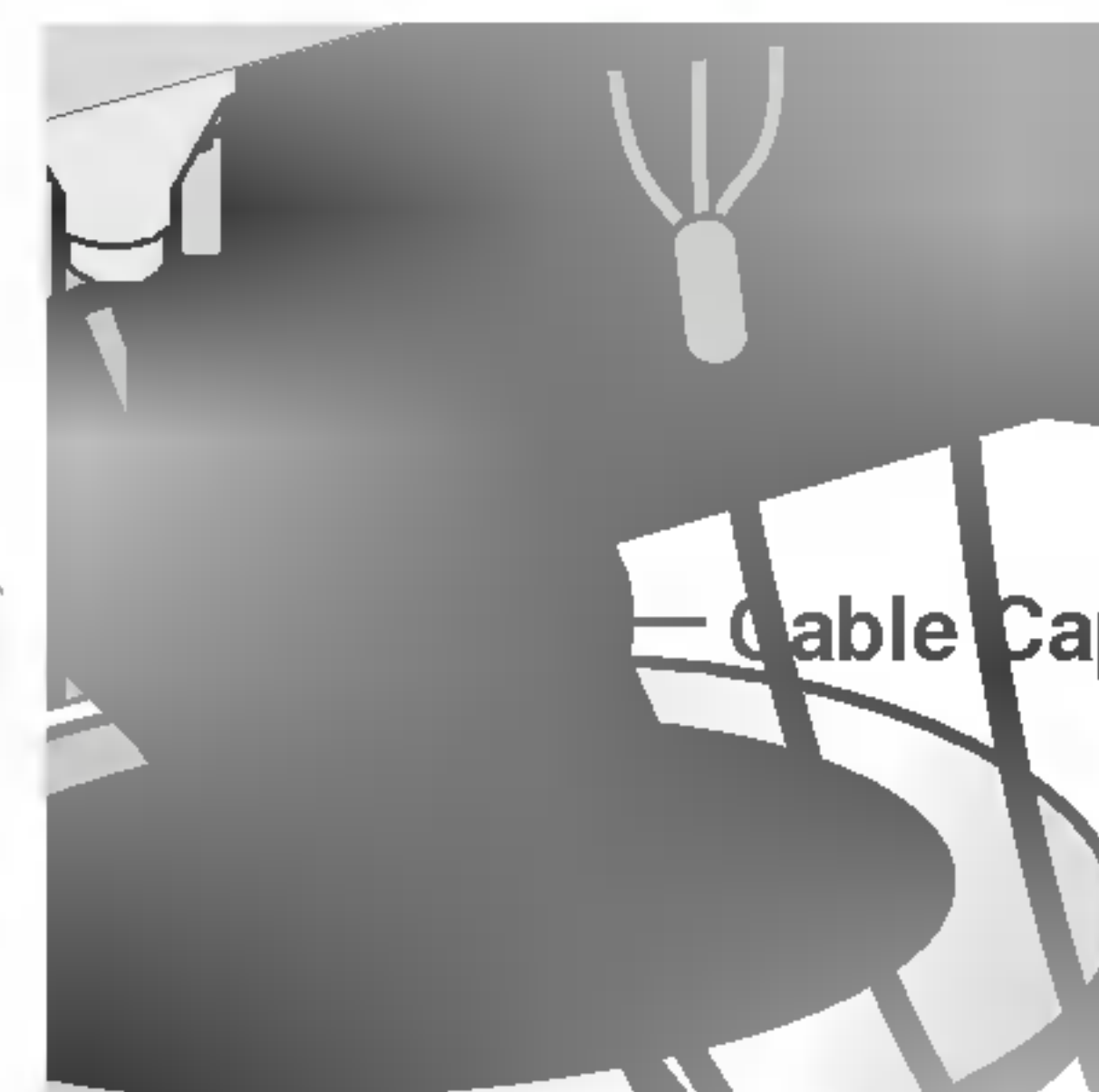
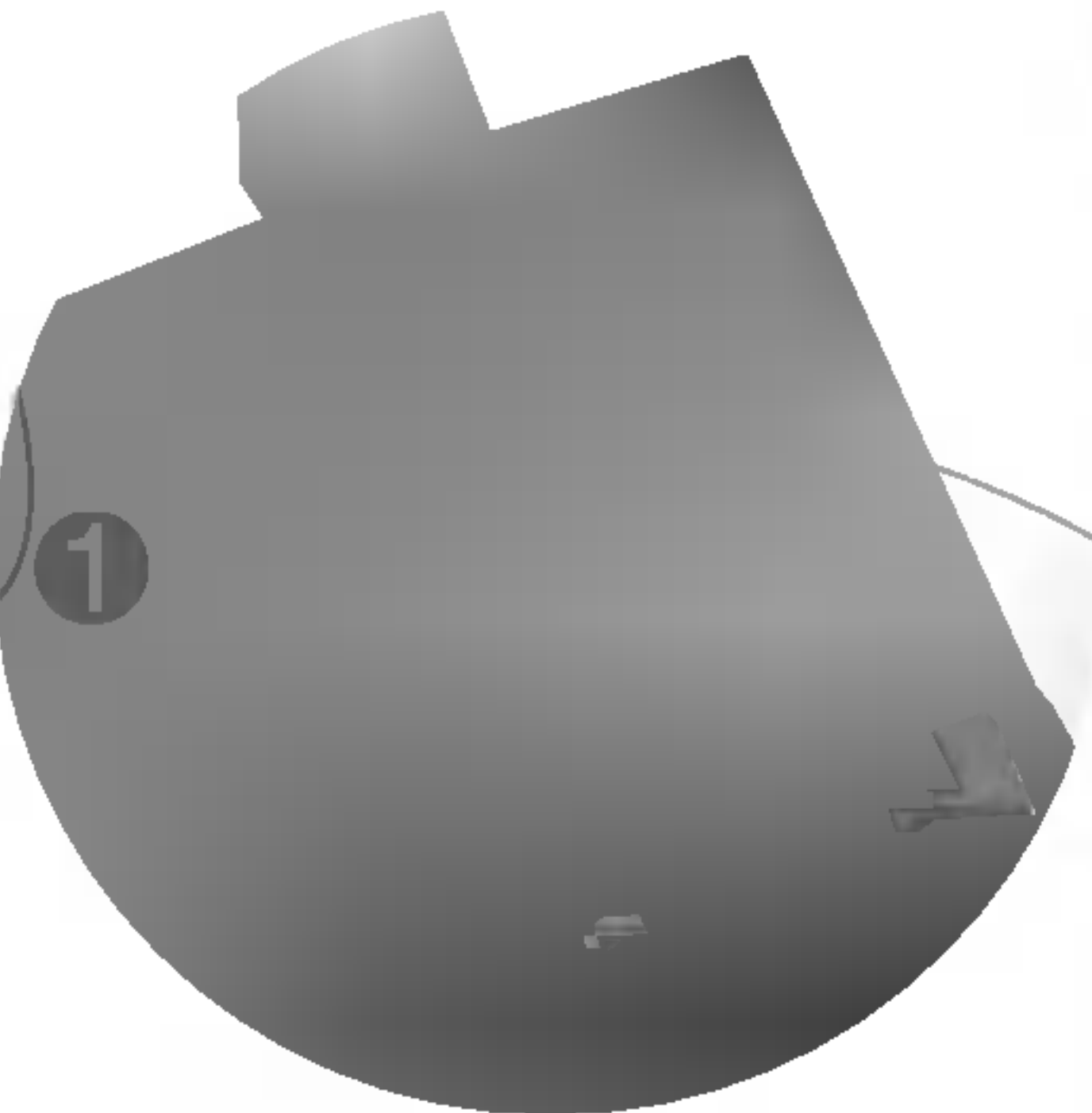
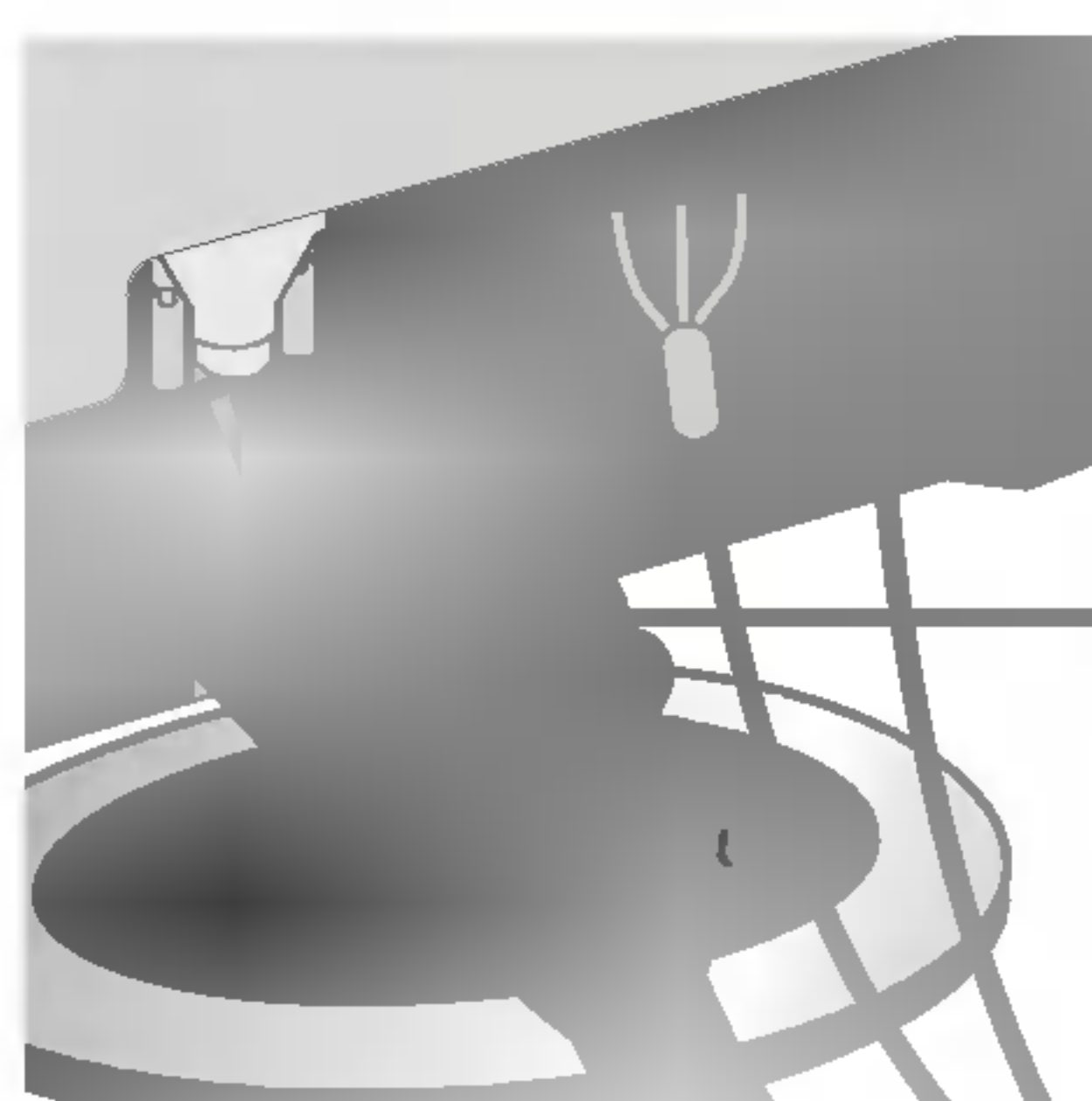

Cable Cap

For detailed instructions of each button on the remote control, refer to the appropriate pages of this manual.

## ● Name of the Remote Controller Buttons

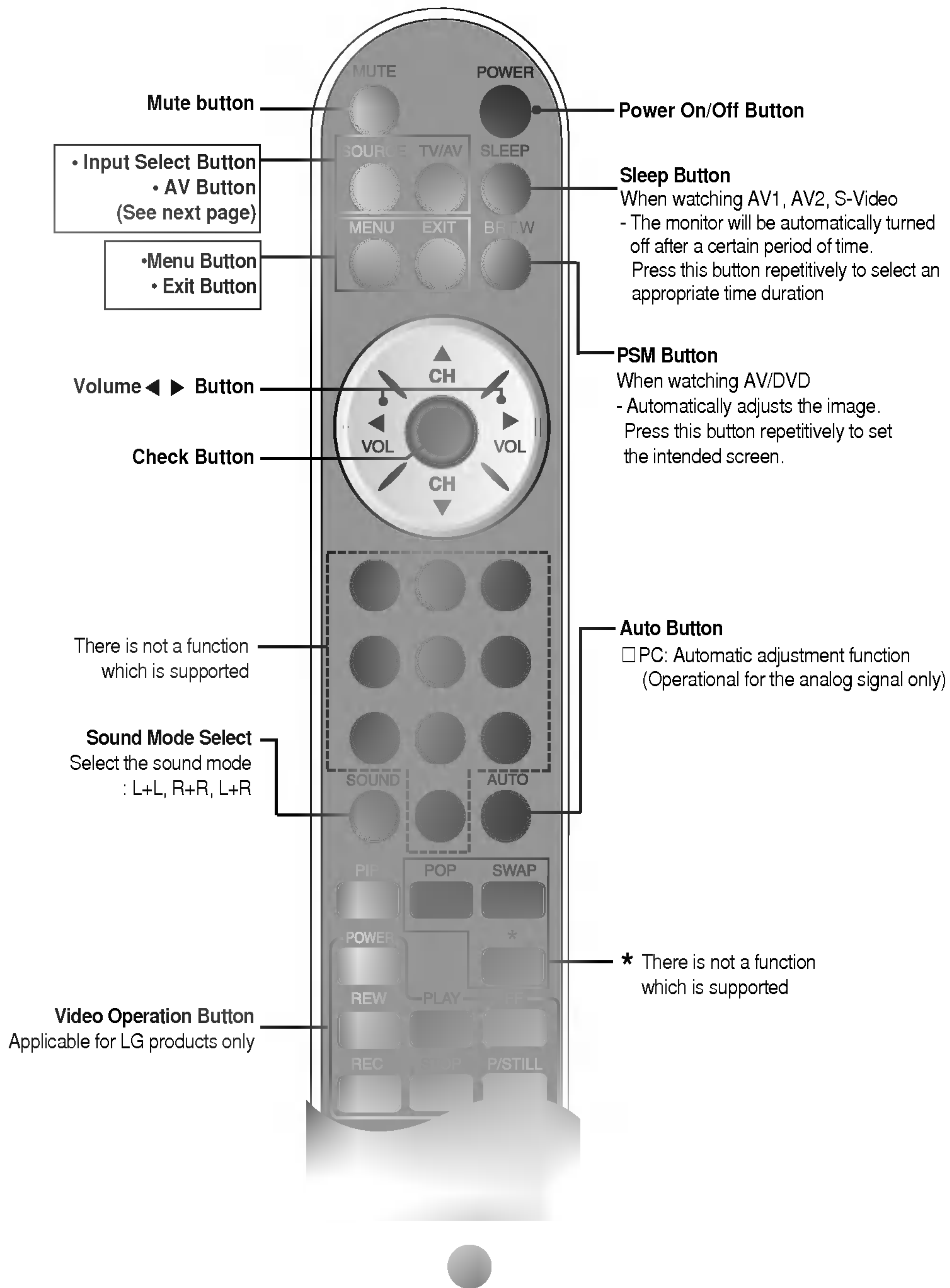



• **Input Select Button**

If you press the button once, the following Input Signal Window will appear. Select the signal type you want using the ▼▲ button.



• **AV Button**

This button will be enabled only when you selected the AV signal. The signal type will be changed with the following order. Set the signal type you want.

AV1-COMPONENT -> AV2-CVBS -> S-VIDEO

• **PIP (Picture in Picture)**

The sub-screen is changed in the order shown below.

: SMALL -> LARGE -> OFF

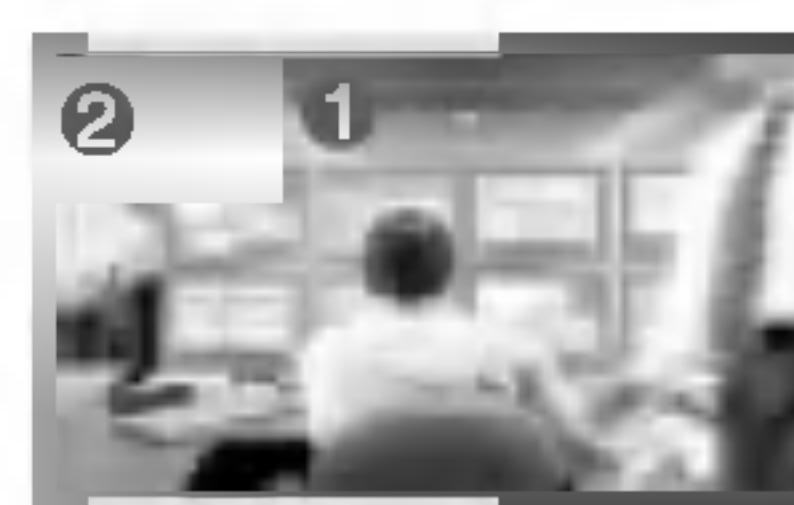

PIP

<Table of PIP Function Support>

Main Screen Sub-Screen	DSUB	DVI	AV1-COMPONENT
DSUB	X	X	X
DVI	X	X	X
AV1-COMPONENT	X	X	X
AV2-CVBS	●	●	●
S-Video	●	●	●

When 'Input Signal 1' comes on in the main screen, only 'Input Signal 2' can be displayed on the sub-screen. On the contrary, if the main screen displays 'Input Signal 2', the sub-screen can display 'Input Signal 1' only.

## ● Rear View

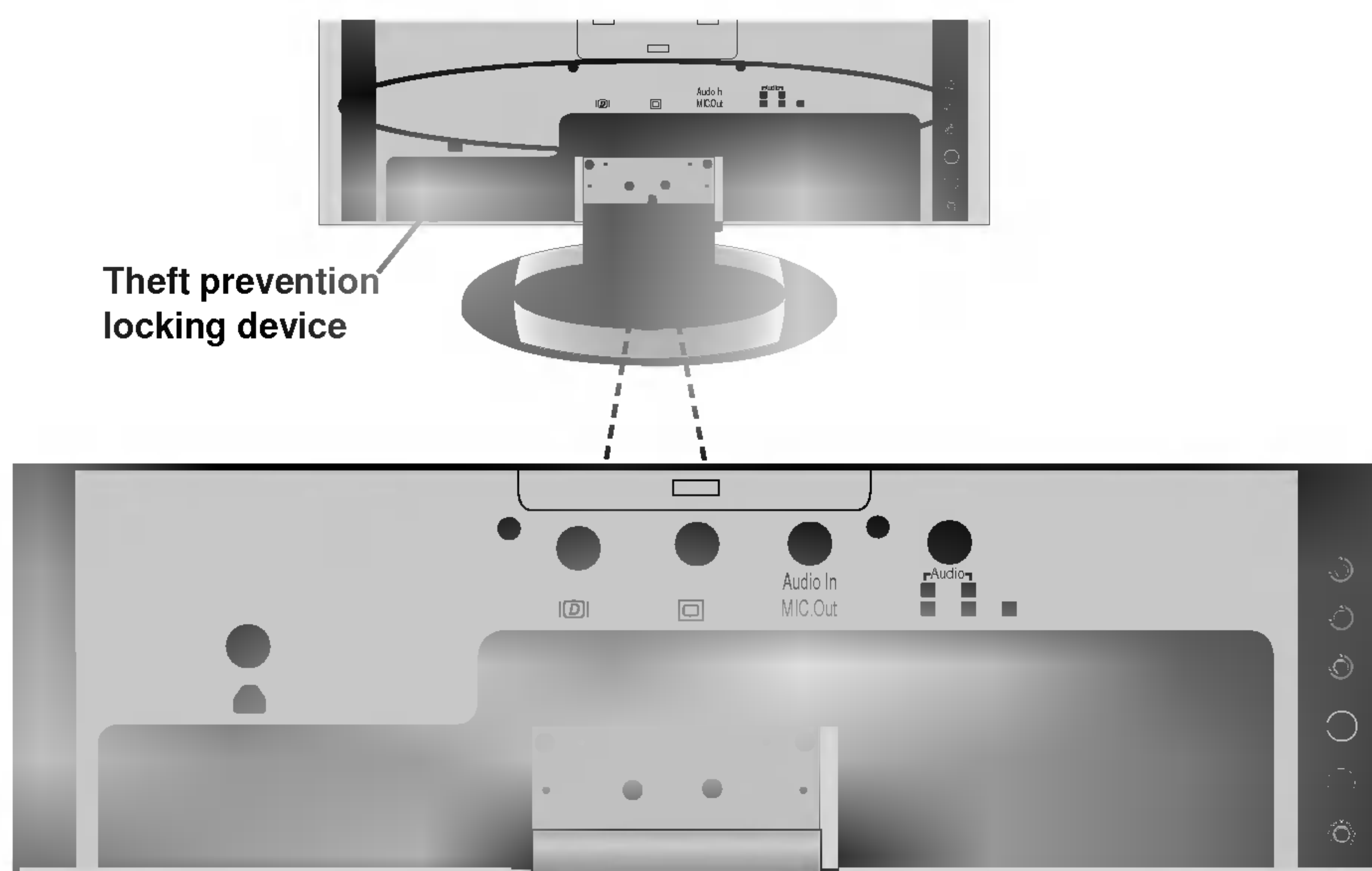

- ① DVI Digital Signal Connector
- ② DSUB Analogue Signal Connector
- ③ Connect to the jack in the PC sound card
- ④ Component Input Terminal
- ⑤ AV Input Terminal
- ⑥ Power Cord Connector : Connect the power cord.

## ● Side View

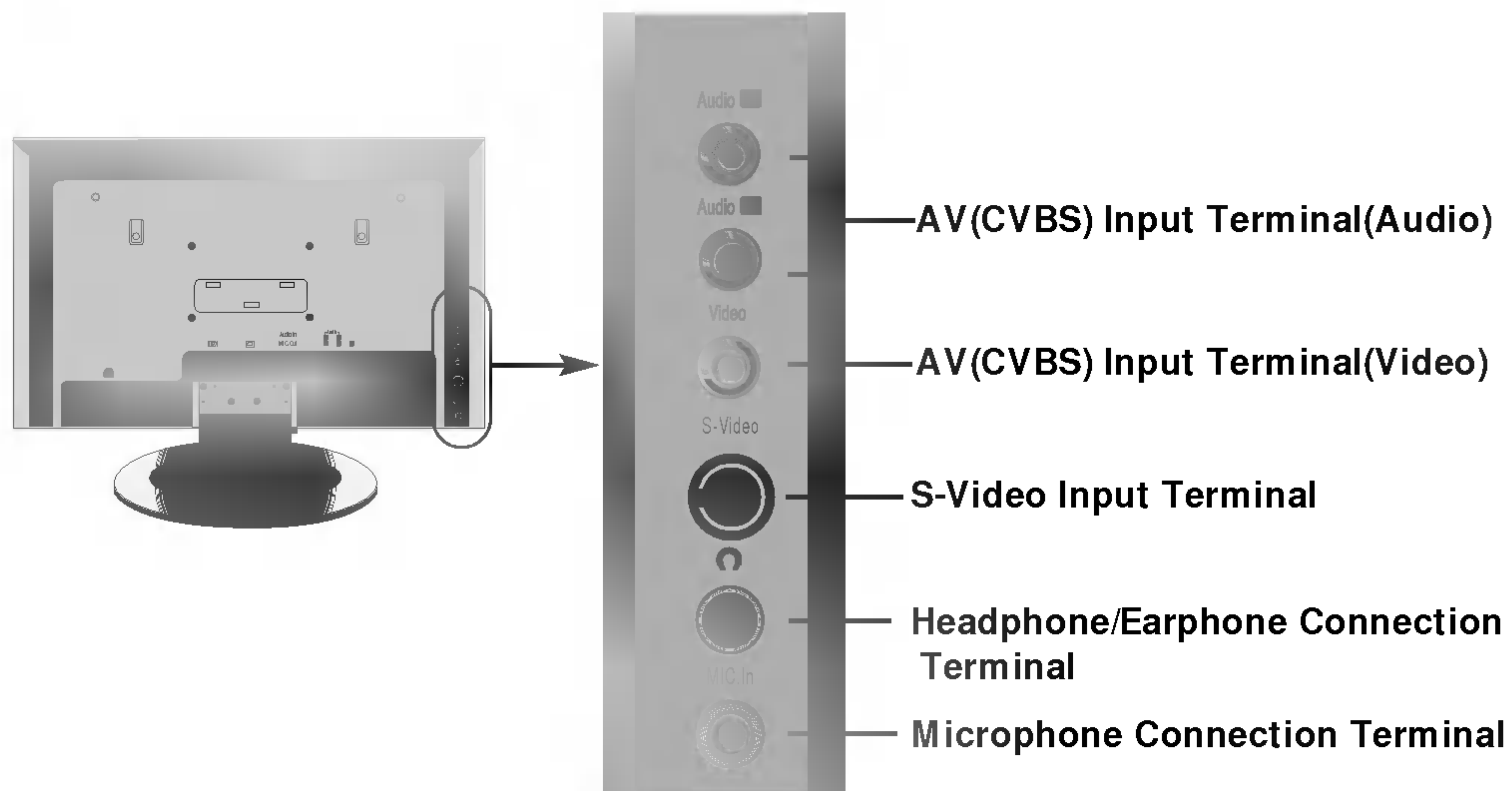

## ● Sound card Connection Terminal Input Terminal

**PC Audio Input Terminal**  
- Connect the audio cable to the LINE OUT jack in the PC sound card.

**Microphone Connection Terminal**  
- Connect the microphone cable to the MIC jack in the PC sound card.

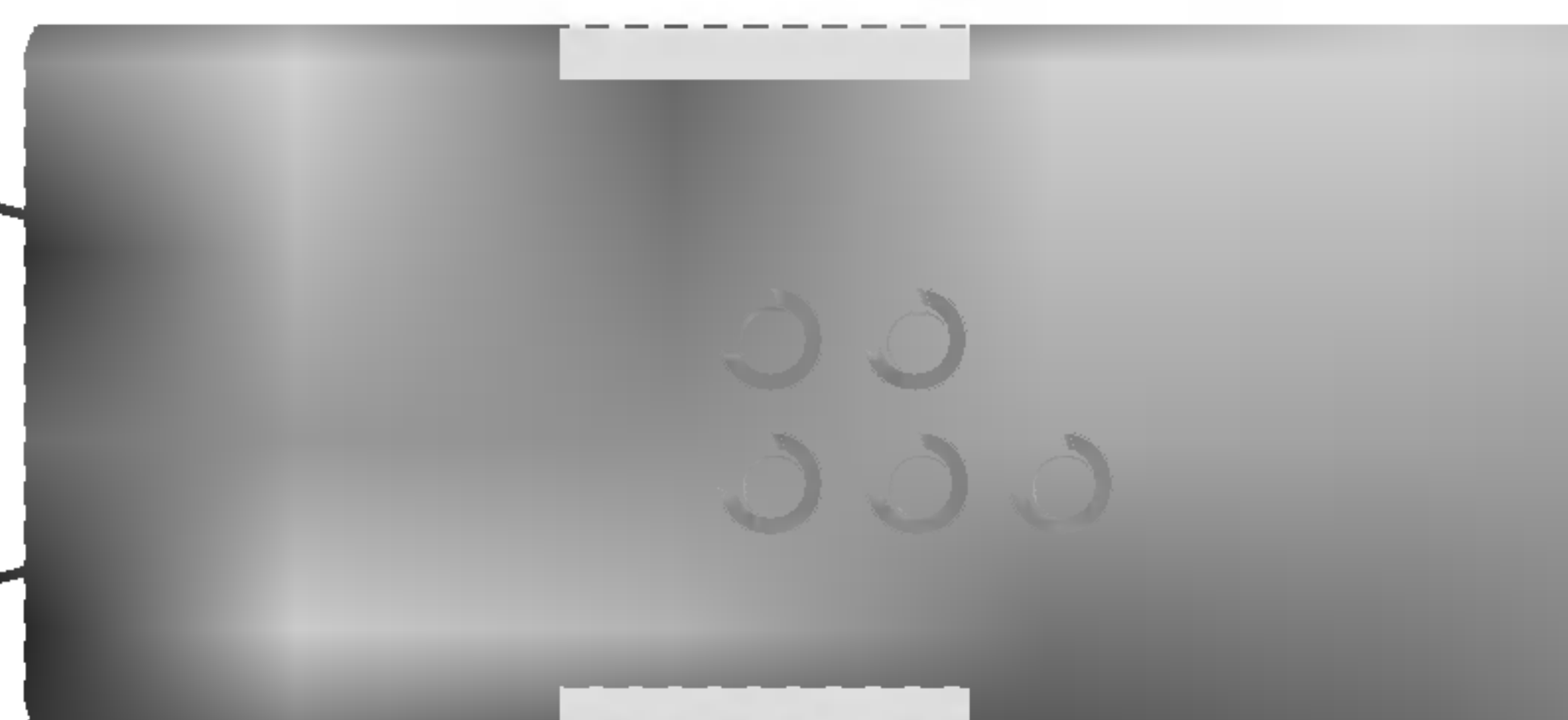

Component Input Terminal

## ● Connecting the sound card output terminal

\* Make sure to check the sound card connection terminal in the PC before connecting to the monitor.

If the PC sound card supports both Speaker Out and Line Out, change it to Line Out by setting the jumper or the PC application. (For more details, refer to the sound card user's manual.)

- **Speaker Out** : The terminal connected to the speaker that is not equipped with an amplifier.

- \***Line Out** : The terminal connected to the speaker equipped with an amplifier.

If Audio Out in the PC sound card has only Speaker Out, reduce the PC volume. This monitor is integrated with an amplifier.

## ■ ■ ■ When Connecting to your PC

**1** First of all, see if the computer, monitor and the peripherals are turned off. Then, connect the signal input cable.

- (A)** When connecting with the DVI signal input cable.
- (B)** When connecting with the DSUB signal input cable. (IBM compatible PC)
- (C)** When connecting with the DSUB signal input cable. (Macintosh)

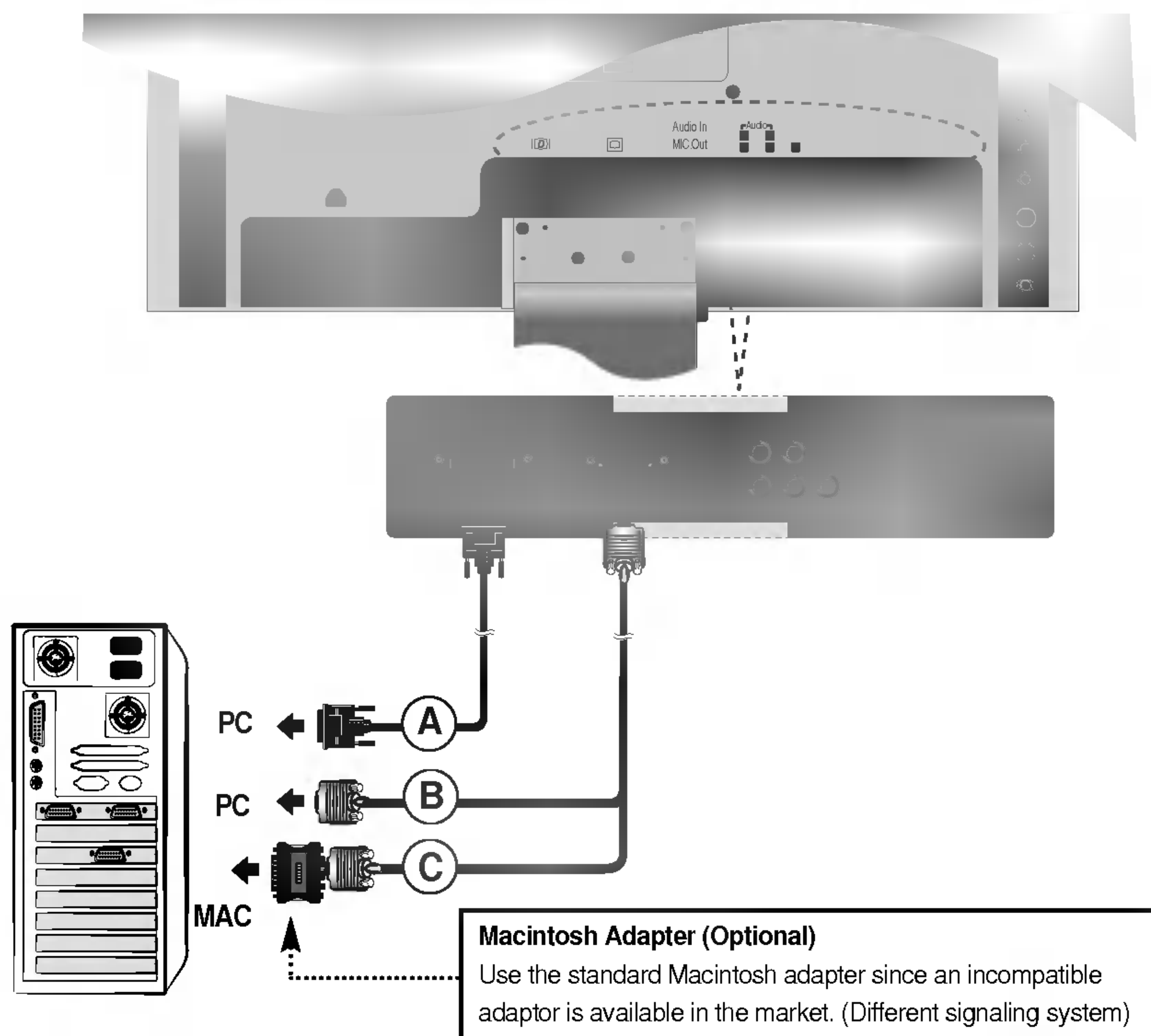

**2** Connect the power cord.

\* When connecting to a wall outlet.

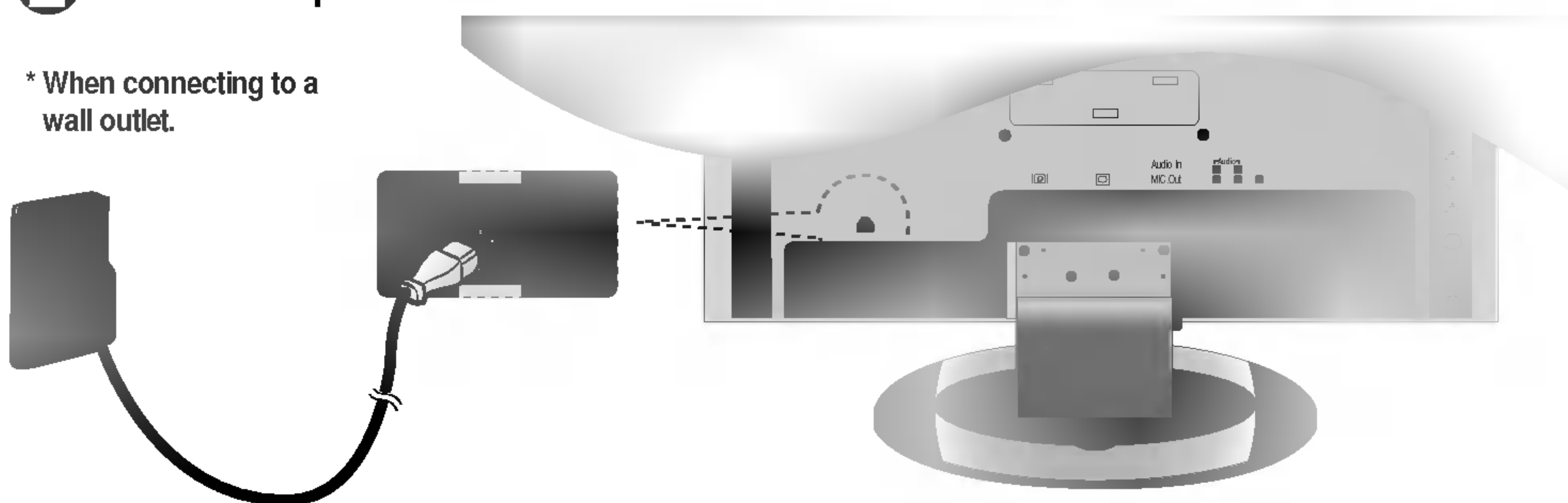



- 3** **A** If the system is not powered up, check if the main power switch is in the 'on' position.

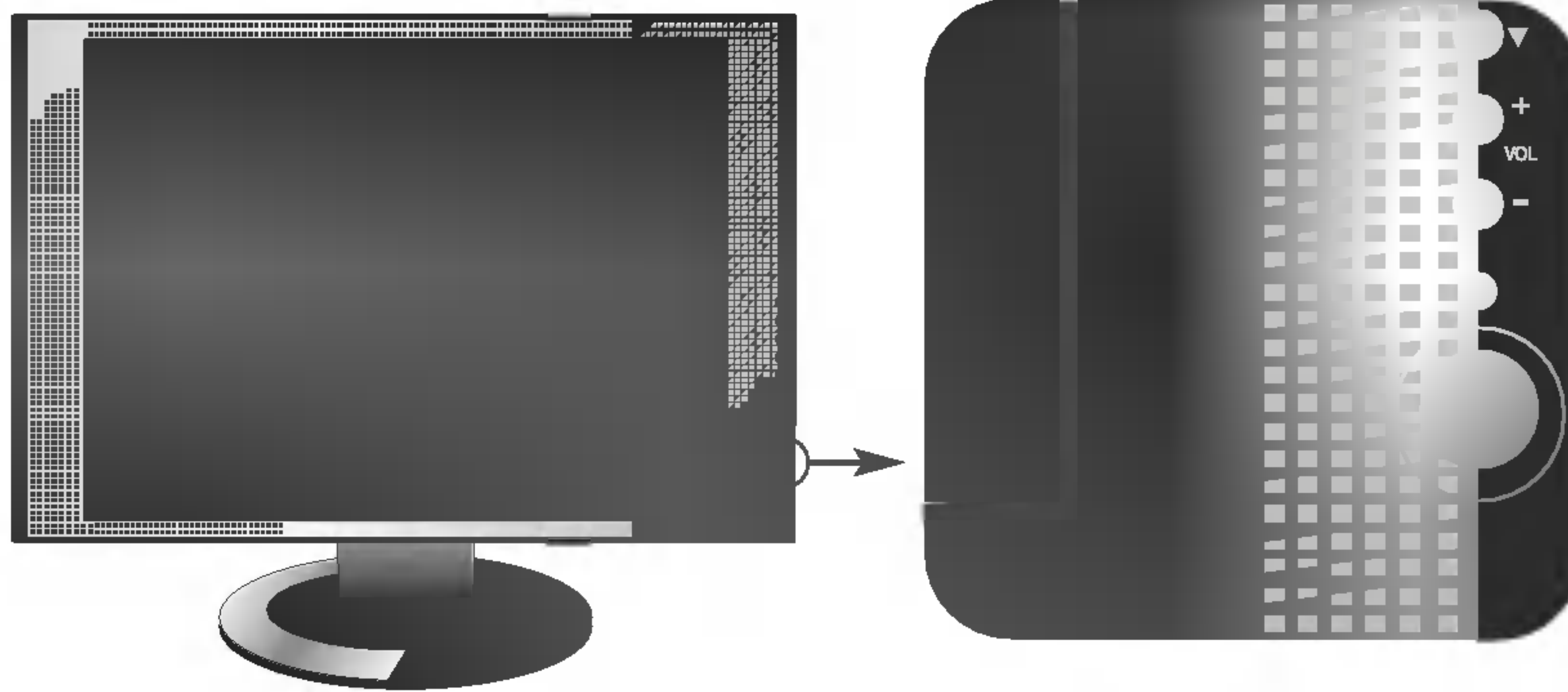

- B** Turn on the PC.

- 4** Select an input signal.  
Press the SOURCE button on the remote controller to select the input signal.  
Or, press the SOURCE button at the front side of the monitor.

**SOURCE** → ▼▲ → **SET**  
(SELECT)

- A** When connecting with a DVI-D signal input cable.  
• Select DVI DIGITAL : DVI-D digital signal.
- B** When connecting with a DSUB signal input cable.  
• Select DSUB ANALOGUE : 15-pin DSUB analogue signal

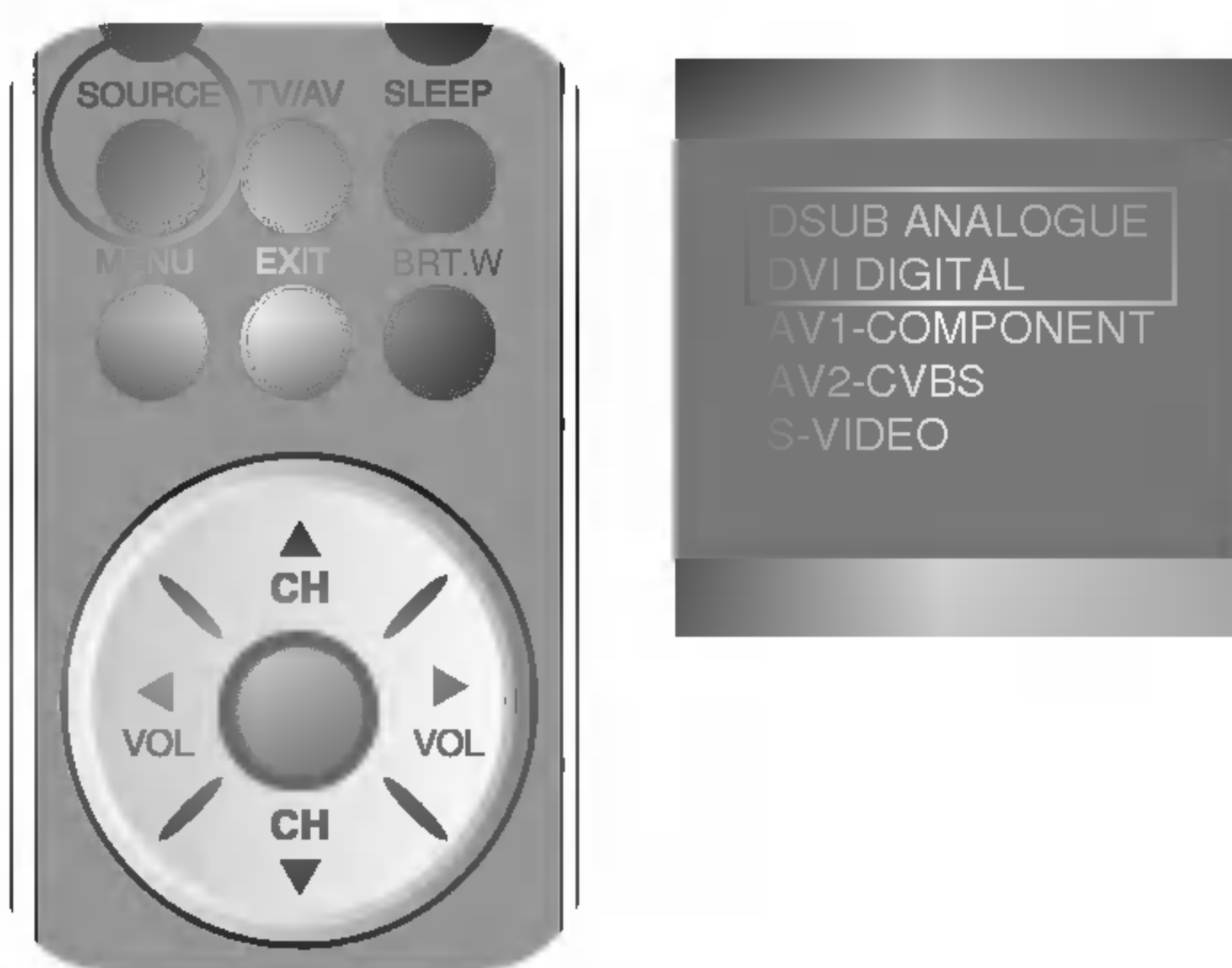

**Note**

\* **How to connect to two computers.**

Connect the signal cables (DVI and DSUB) to each computer.

Press the SOURCE button in a remote controller to select the computer to use.

\* Directly connect to a grounded power outlet on the wall or a power bar with a ground wire.

## ■ ■ ■ When watching Video/ DVD

**1** Connect the video cable as shown in the below figure and then connect the power cord (See page A11).

**A** When connecting with an RCA cable.

- Connect the input terminal with a proper colour match. (Video – Yellow, Sound (left) – White, Sound (right) – Red)

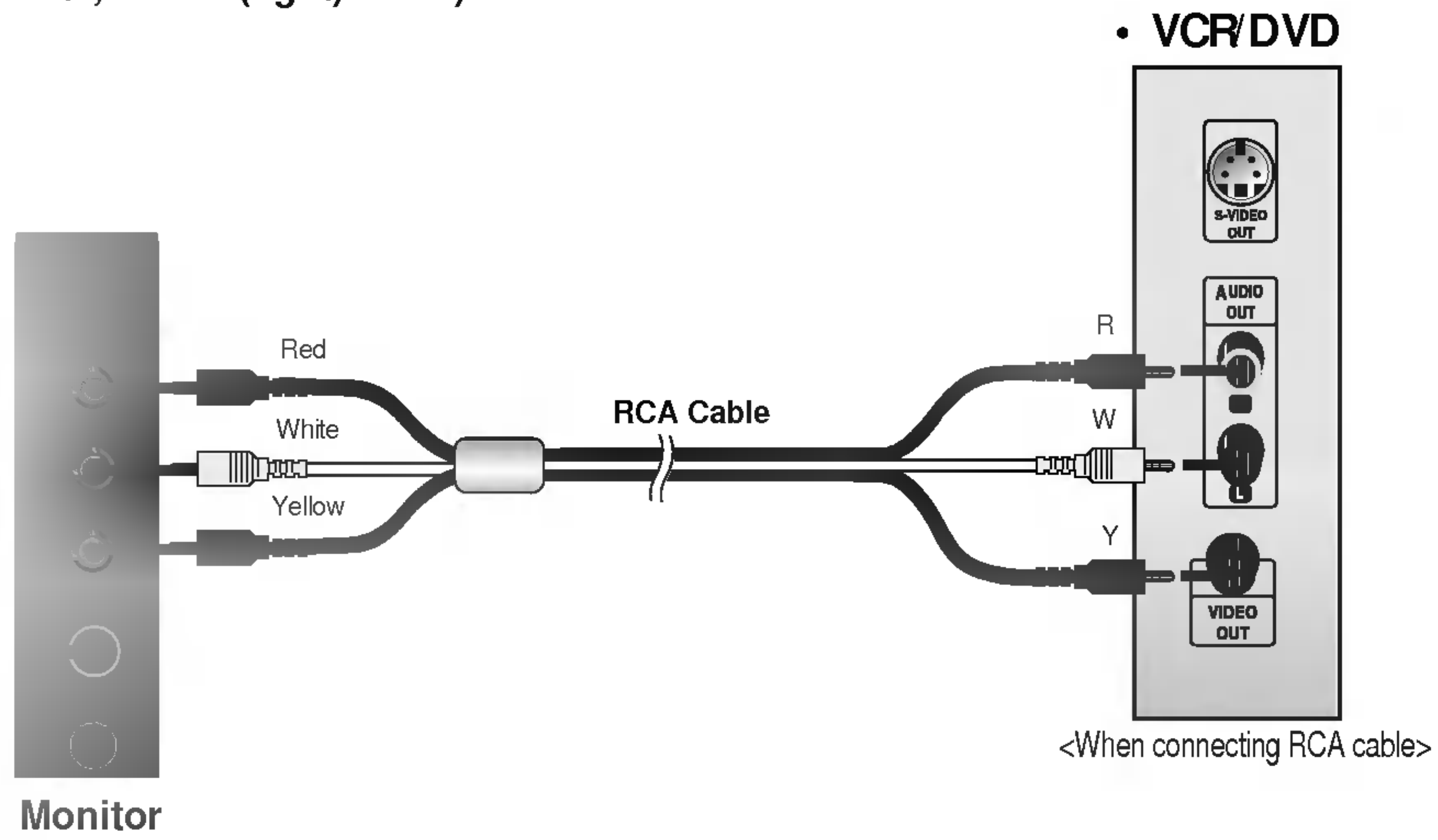

**B** When connecting with an S-Video cable.

- Connect to the S-Video input terminal to watch high image quality movies.

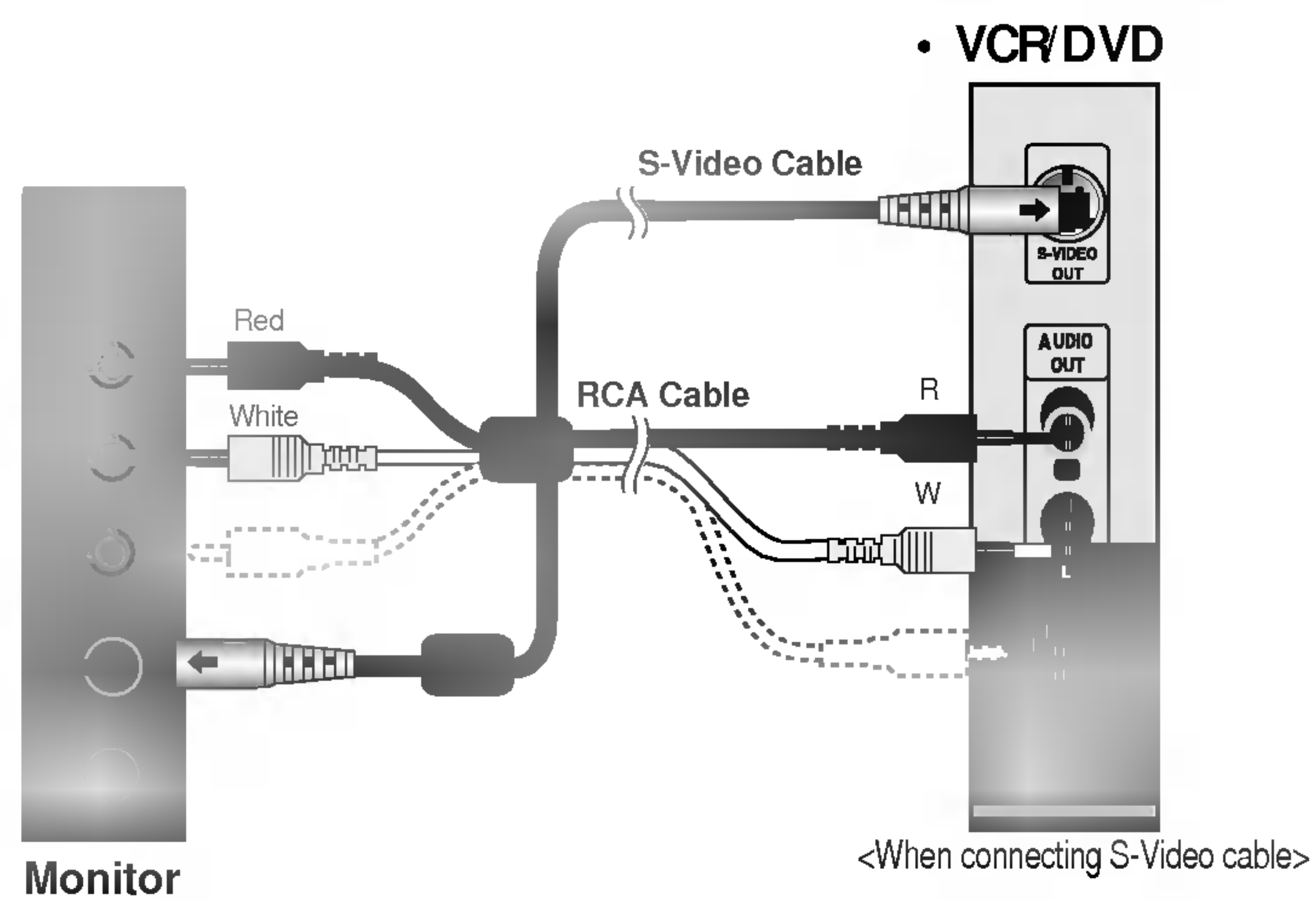

- ② Connect the video/audio cable as shown in the below figure and then, connect the power cord.
- Connect the input terminal with a proper color match.

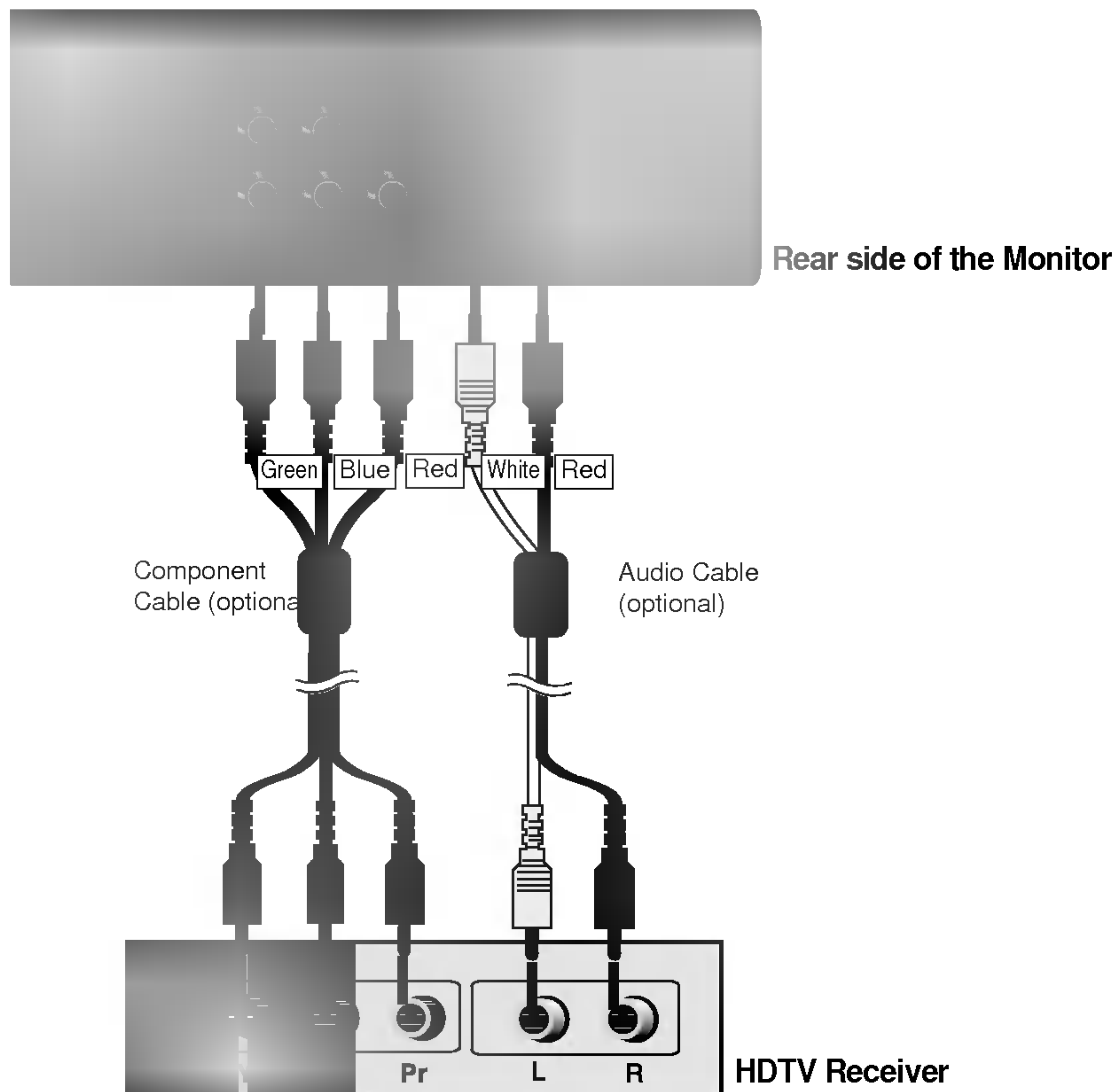

- ③ Select an input signal.  
Press SOURCE button on the remote controller to select the input signal. Or, press the SOURCE button at the front side of the monitor.

**SOURCE** → ▼▲ → **SET**  
(SELECT)

- ④ When connecting with a RCA cable.
  - Select AV2-CVBS
- ⑤ When connecting with a S-Video cable.
  - S-VIDEO
- ⑥ When connecting with a Component cable/Audio cable.
  - Select AV1-COMPONENT



## ● Name of the Buttons in the Screen Adjustment Unit

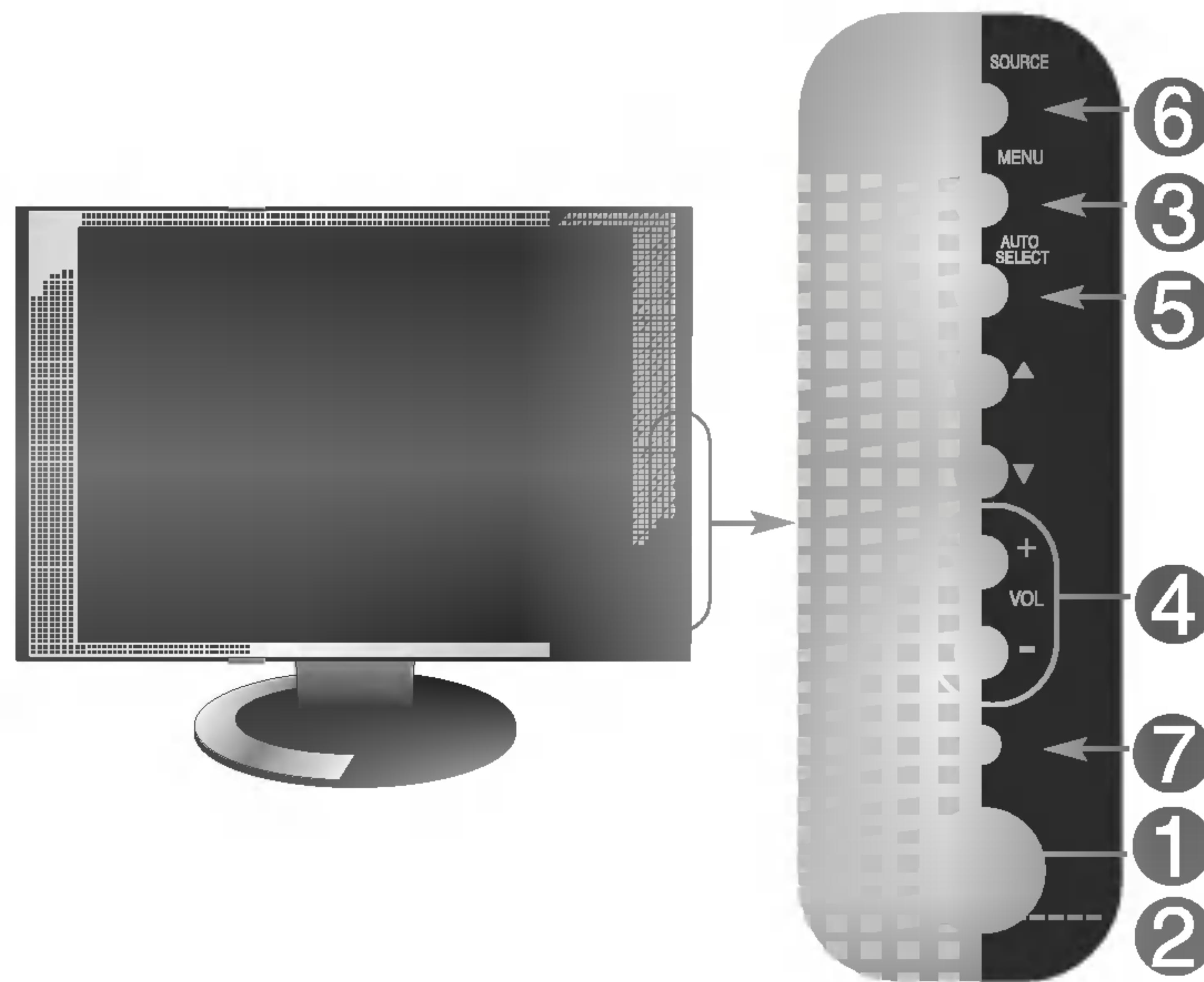

**1** **Power Button** • Press the button to turn on the power. Press the button again to turn it off.

**2** **Power LED** • This Indicator lights up blue when the display operates normally. If the display is in DPM (Energy Saving) mode, this indicator colour changes to amber.

**3** **MENU Button** • Use this button to show/hide the OSD (On Screen Display) menu screen.

**4** **OSD Select Adjust Button** • Use the button to select an icon or adjust the setting in the OSD screen.

+ - • Adjust the volume.





## ● Name of the Buttons in the Screen Adjustment Unit

**5** **AUTO/SELECT Button** [For PC Analogue signal]



**6** **SOURCE Button** SOURCE -> ▼▲ -> AUTO/SELECT (Remote Controller:OK)



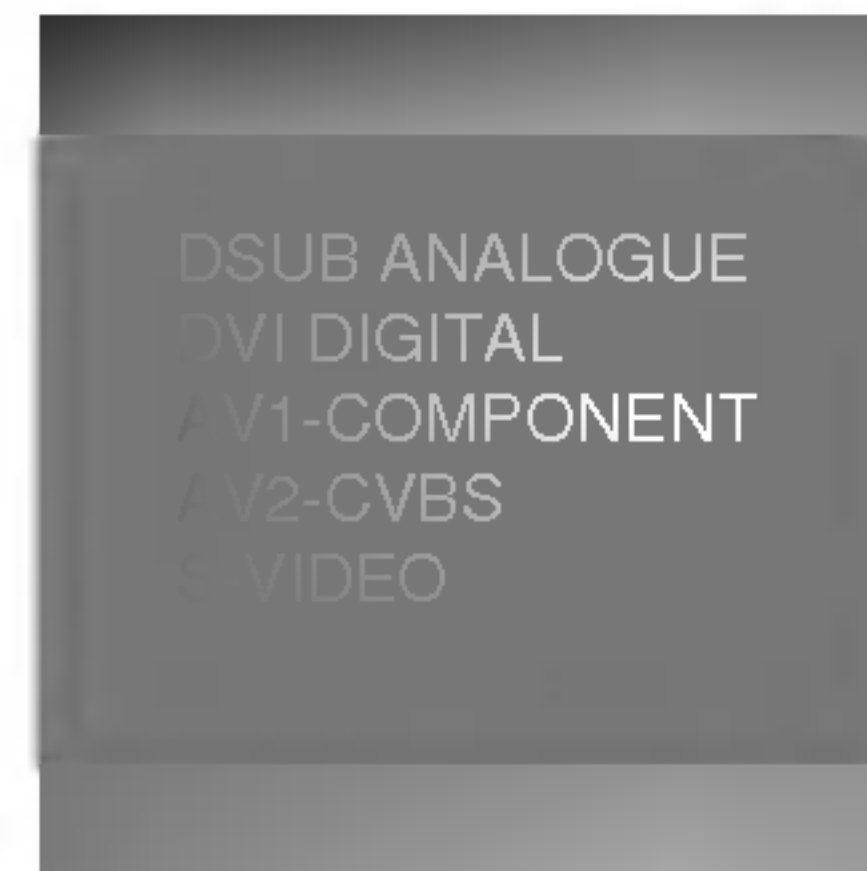

- Select the input signal

<b>DSUB ANALOGUE</b>	15-pin D-Sub analogue signal
<b>DVI DIGITAL</b>	DVI digital signal
<b>AV1-COMPONENT</b>	Component
<b>AV2-CVBS</b>	Composite video
<b>S-Video</b>	Separate Video



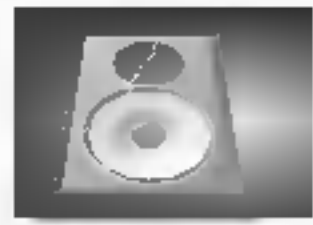

**7**  • The unit that receives the signal from the remote controller.

## OSD Menu – When Connected to Your PC

Icon	Function Description
 PICTURE	Adjusts screen brightness, contrast and colour that you prefer.
 SOUND	Adjusts the audio function.
 ADJUSTMENT	Adjusts position of the screen, clock and phase.
 PIP	Adjusts PIP mode function.
 SETUP	Adjusts the screen status according to the circumstances.

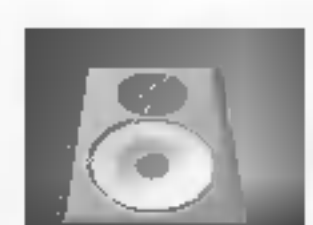
## OSD Menu – When Watching Video/DVD

Icon	Function Description
 PICTURE	Adjusts the screen video.
 SOUND	Adjusts the audio function.
 PIP	Adjusts PIP mode function. (Available only AV1-COMPONENT)
 SETUP	Adjusts the screen status according to the circumstances.



### Note

#### OSD(On Screen Display)

The OSD function enables you to adjust the screen status conveniently since it provides graphical presentation.



## ● How to adjust the OSD (On Screen Display) screen.

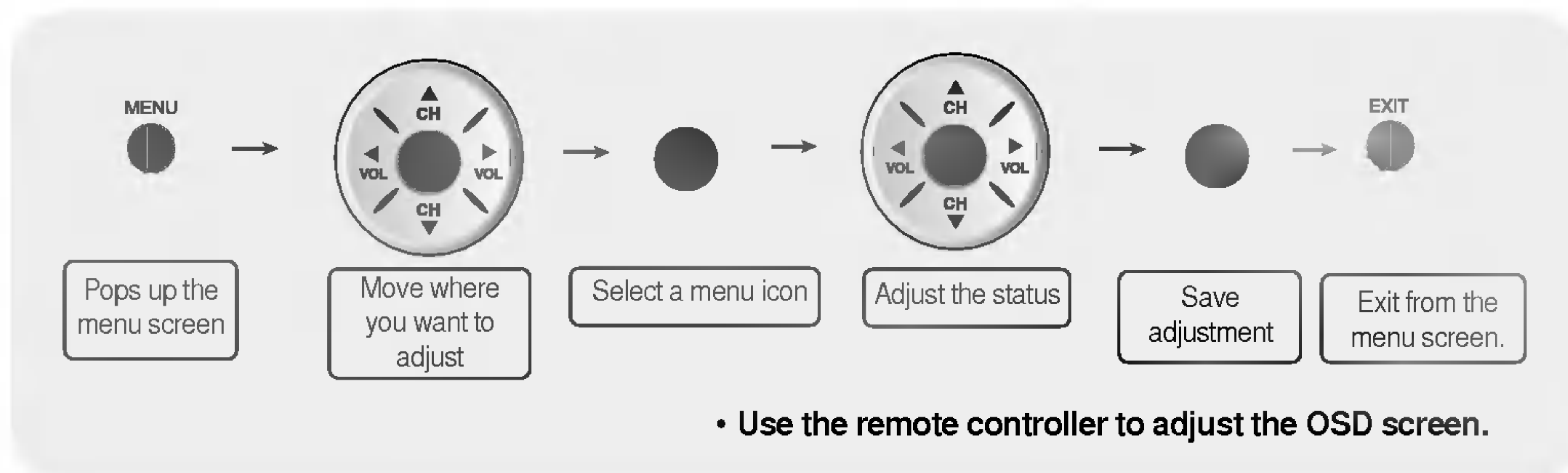

Press the **MENU** Button, then the main menu of the OSD appears.

To access a control, use the **▼ ▲** Buttons.

When the icon you want becomes highlighted, press the **SET** Button.

Use the **▼ ▲ ◀ ▶** Buttons to adjust the item to the desired level.

Accept the changes by pressing the **SET** Button.

Exit the OSD by Pressing the **EXIT** Button.

## ● How to adjust the screen automatically.

You need to adjust the screen display when connecting the monitor to a new computer or changing the mode. Refer to the following section to set an optimal monitor screen.

Press the **AUTO/SELECT** button (**AUTO button** in a remote controller) in the PC analogue signal. Then, an optimal screen status will be selected that fits into the current mode.

If adjustment is not satisfactory, you need to adjust screen position, clock and phase in the OSD menu.

## ■■■ OSD Menu – When Connected to Your PC

### Adjusting Screen Colour

PSM

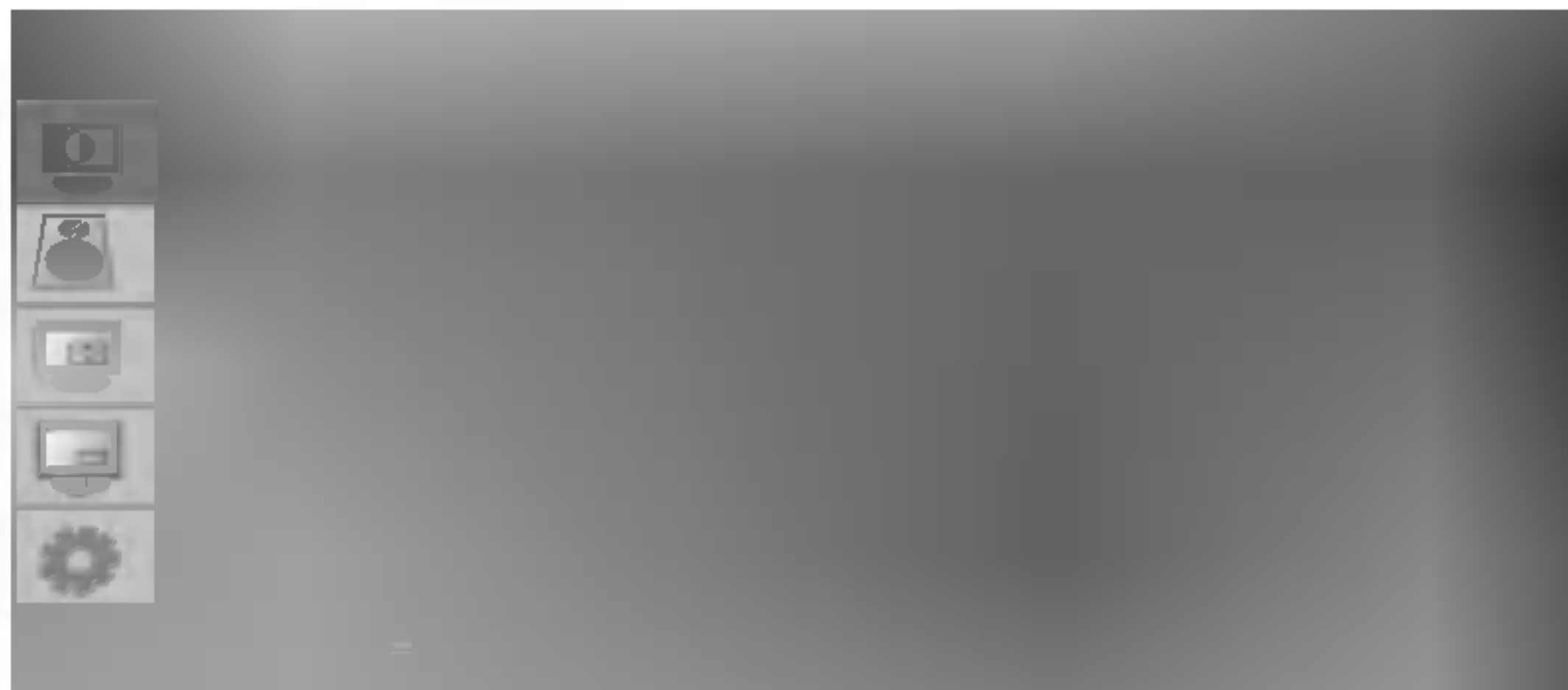

**Contrast**

To adjust the contrast of the screen.

**Brightness**

To adjust the brightness of the screen.

CSM

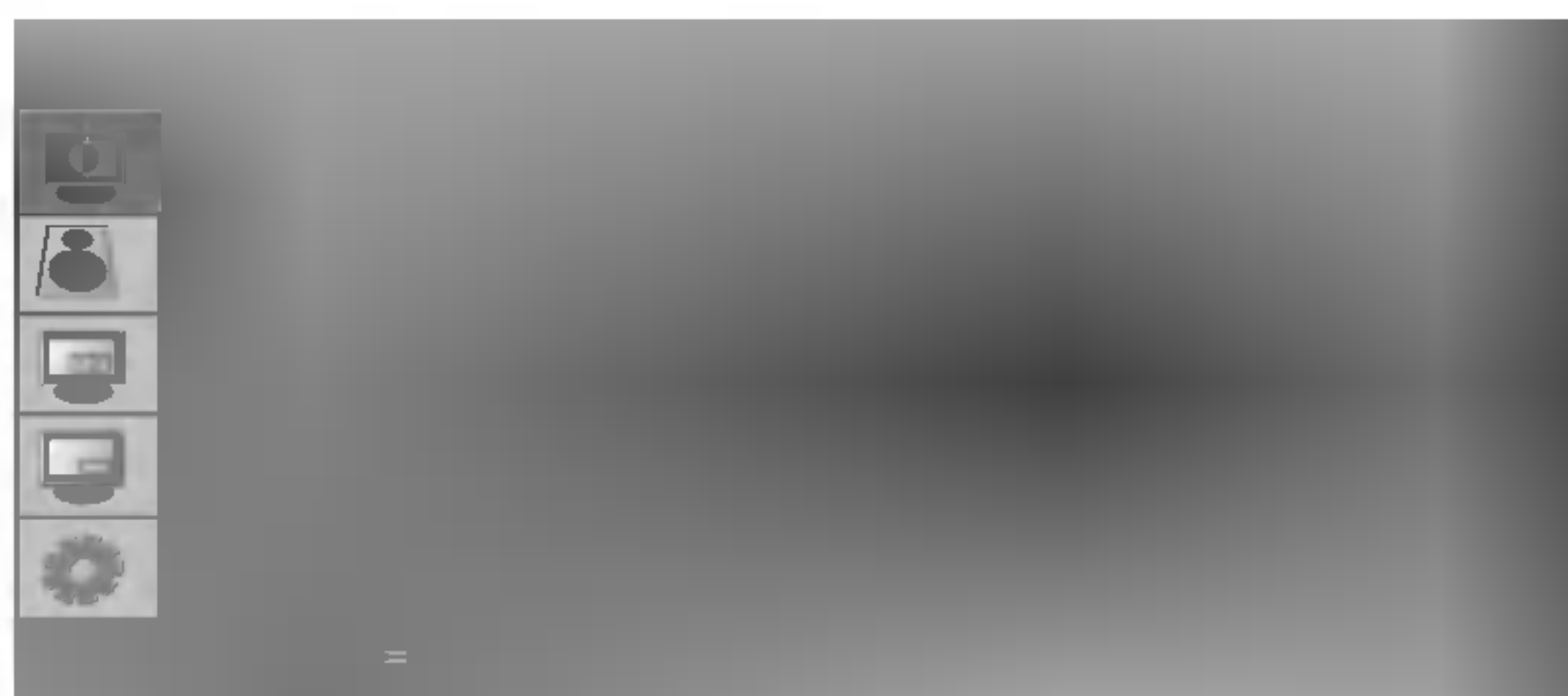

DSUB ANALOGUE/DVI DIGITAL  
input only

- **6500K/9300K**

Selecting a factory setting colour set.

6500K: Slightly reddish white.

9300K: Slightly bluish white.

- **User** : Select this option to use the user-defined settings.

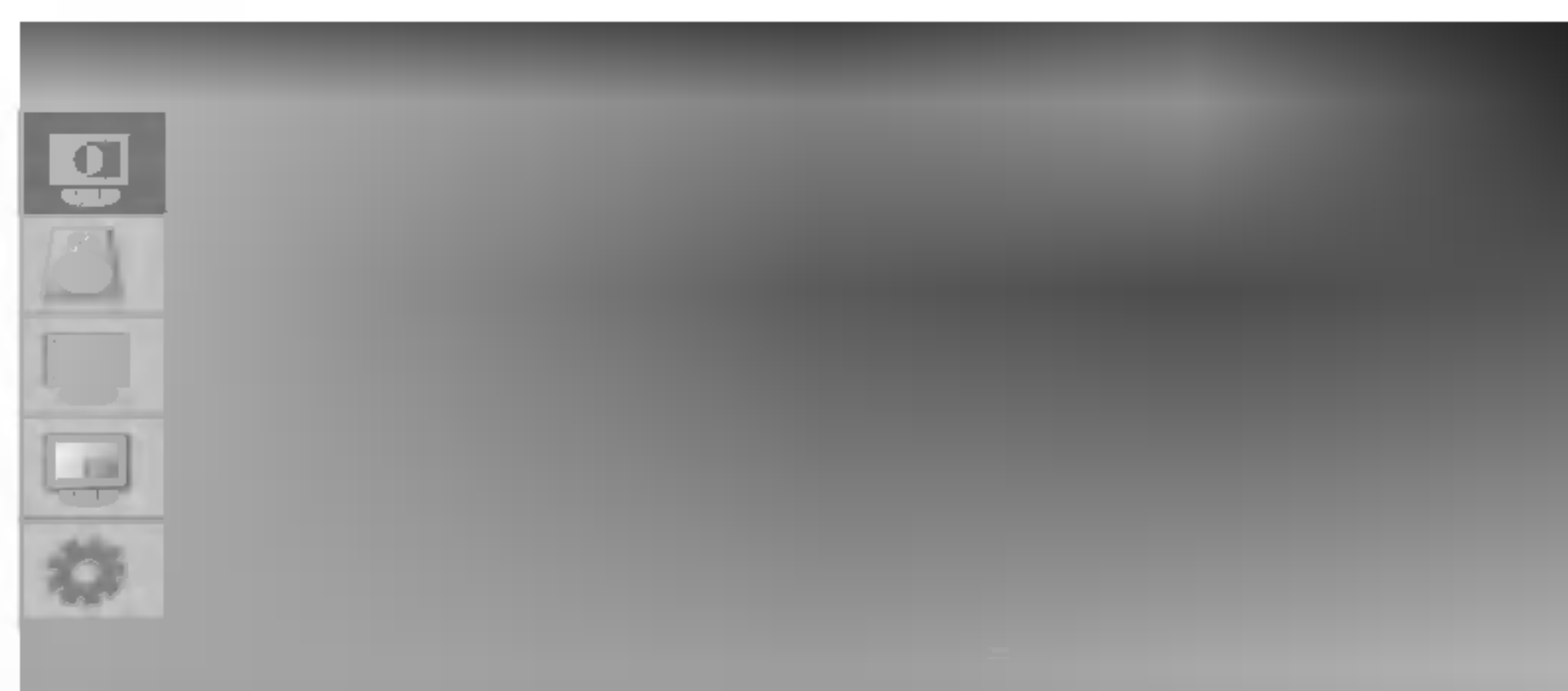

**Red / Green / Blue**

Set your own colour levels.



**Note**

If the input is DSUB ANALOGUE/DVI DVI DIGITAL, the adjustable items in the PSM function are Contrast/Brightness



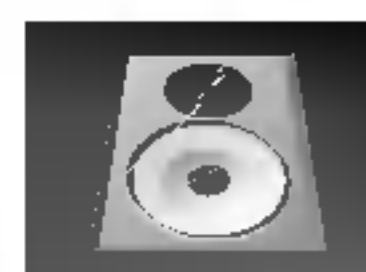

## Adjusting the audio function



SSM

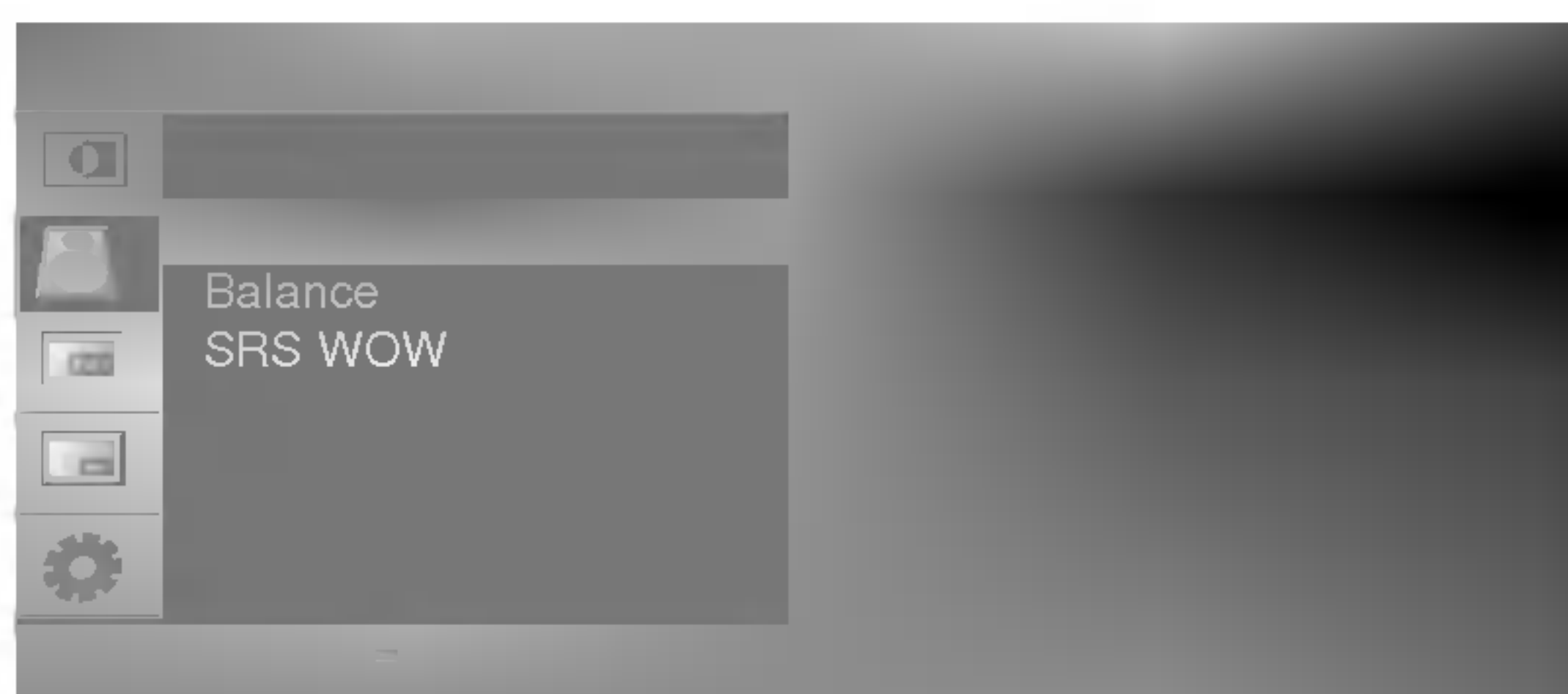

The best sound tone quality will be selected automatically depending on the video type that you're currently watching.

- **Flat** : The most commanding and natural audio.
- **Music** : Select this option to enjoy the original sound when listening to the music.
- **Movie** : Select this option to enjoy sublime sound.
- **Speech** : Select this option to watch sports broadcasting.
- **User** : Select this option to use the user-defined audio settings.

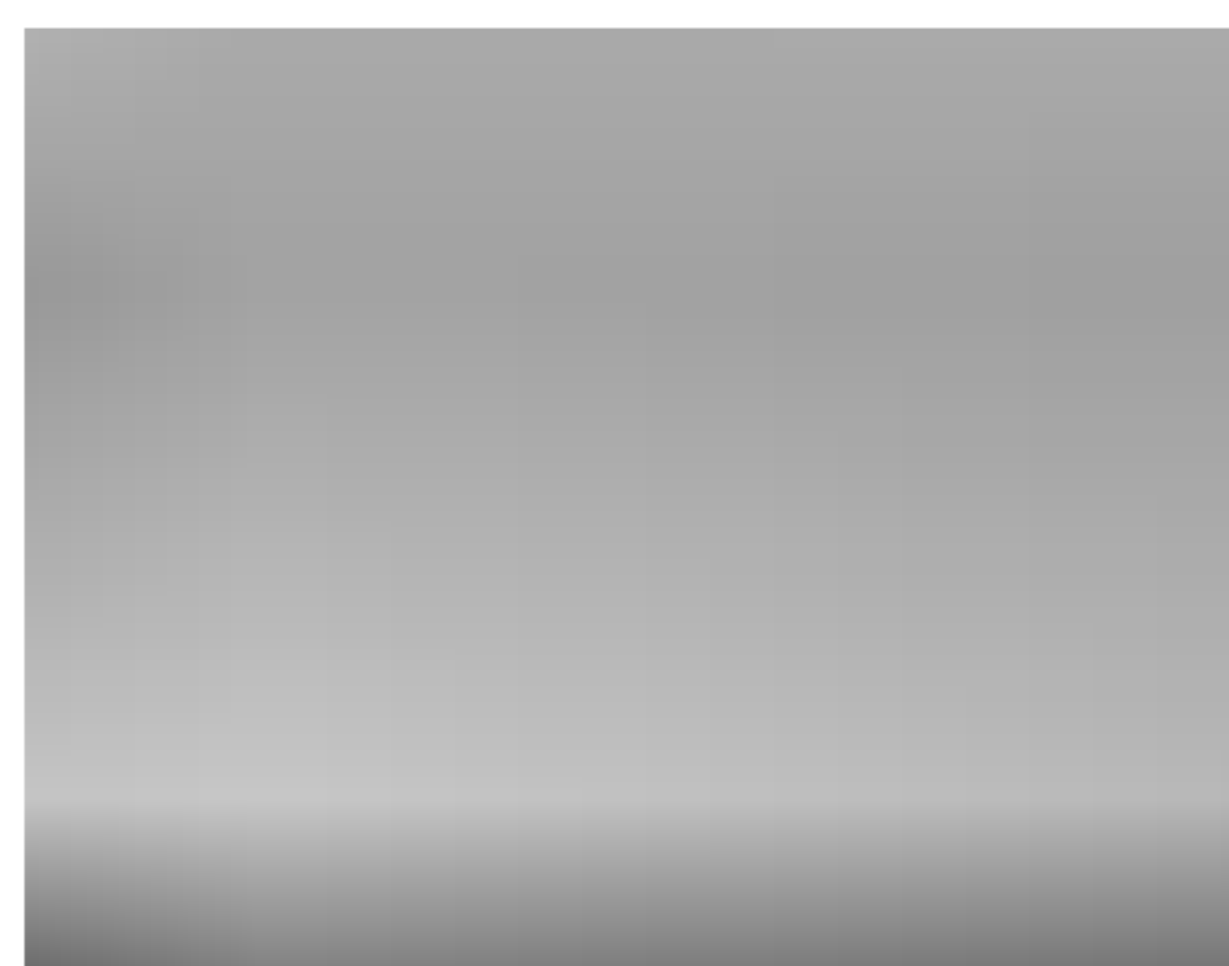

**Balance** Use this function to balance sound from the left and right speakers.

**SRS WOW** Set the SRS WOW menu on.  
The SRS WOW function plays back the mono or stereo sound input with the dynamic surround effects. It will provide rich and profound sound tone.  
If you set the SRS WOW on, user audio setting can not be adjusted.



**Note**

When connected to your computer and the 'SSM' setting in the audio menu is one of Flat, Movie, Music or Speech, the available menus are Balance and SRS WOW .



## Adjusting Screen CLOCK/PHASE and Position (Only Dsub)

---

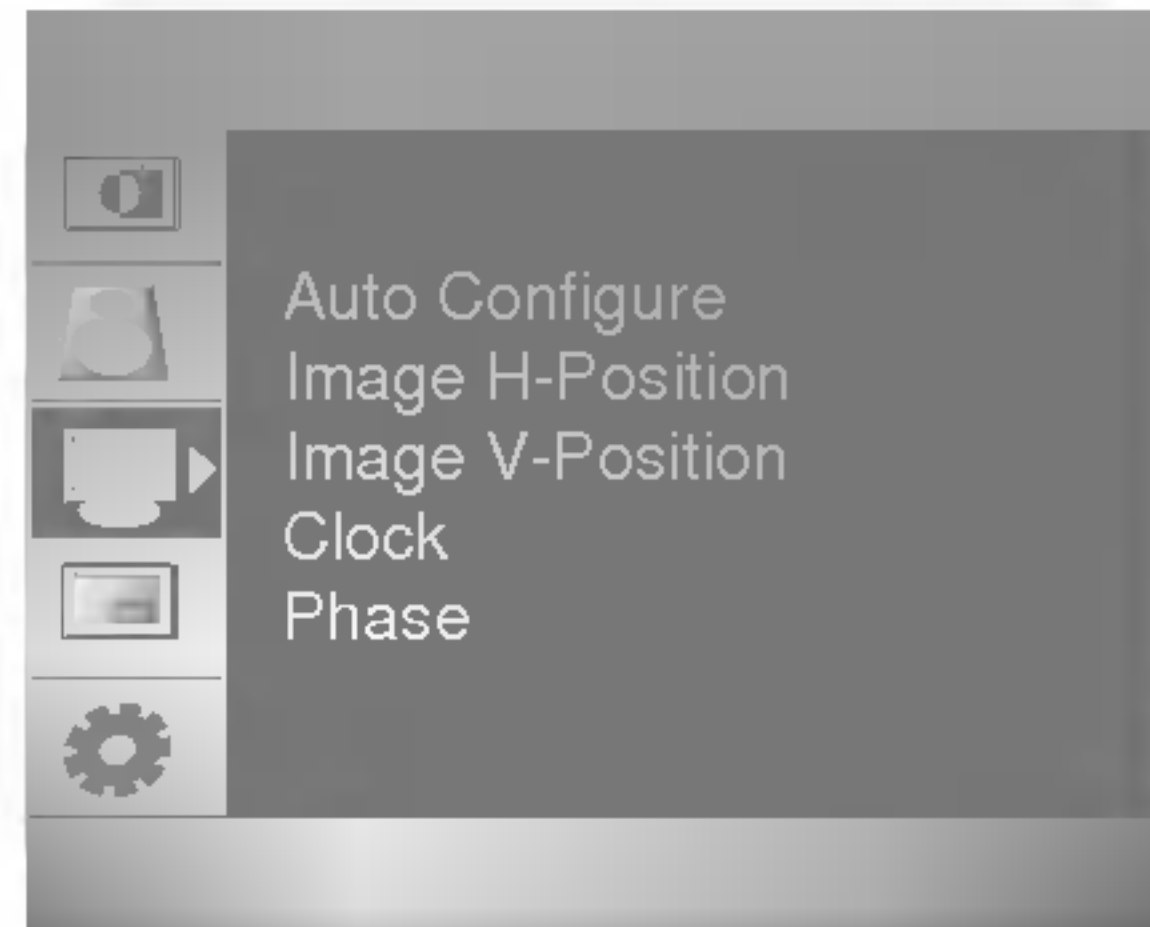

- |                         |  |
|-------------------------|--|
| <b>Auto Configure</b>   | This function is suitable for analogue signal input only. This button is for the automatic adjustment of the screen position, clock and phase. |
| <b>Image H-Position</b> | To move image left or right  |
| <b>Image V-Position</b> | To move image up or down.  |
| <b>Clock</b>            | To minimize any vertical bars or stripes visible on the screen background. The horizontal screen size will also change.                        |
| <b>Phase</b>            | To adjust the focus of the display. This item allows you to remove any horizontal noise and clear or sharpen the image of characters.          |
- 
- 



## Adjusting PIP Mode (Multiple Screen) Functions

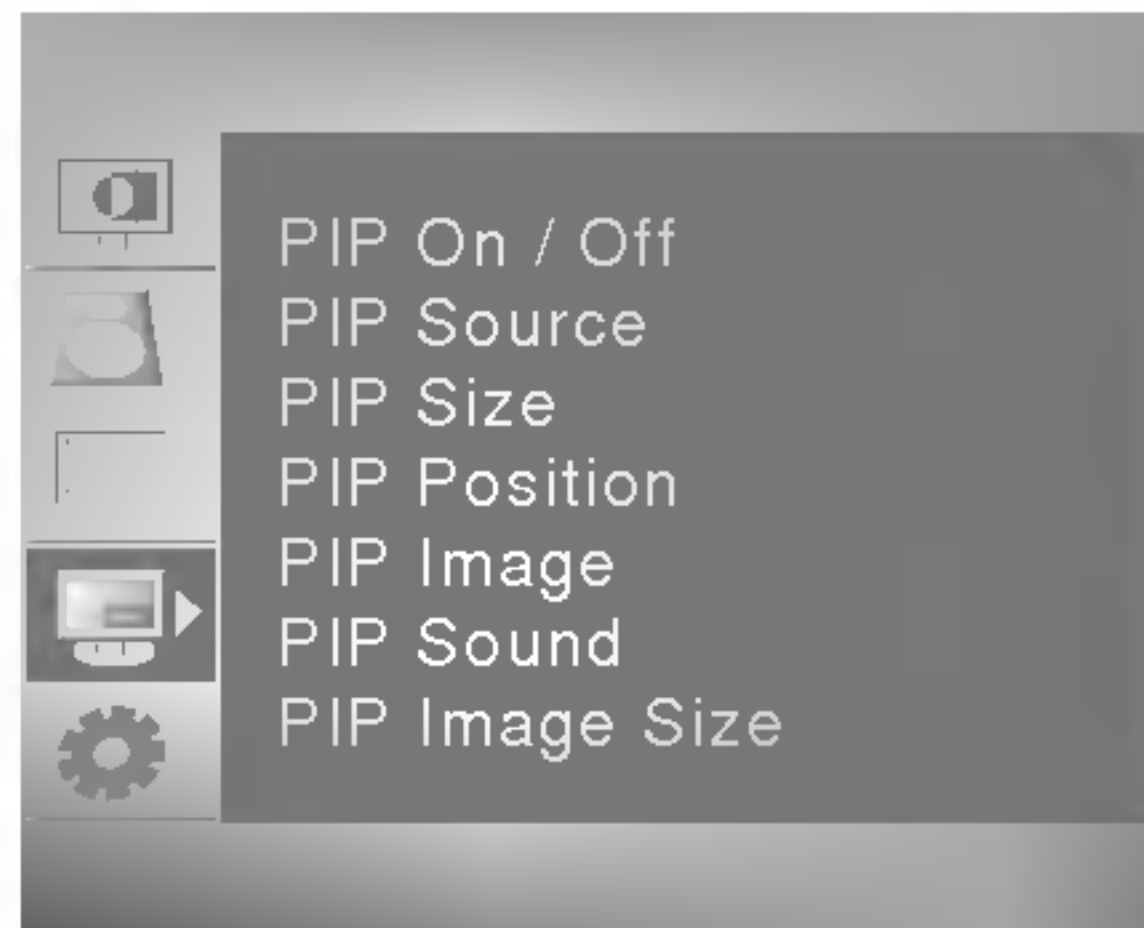

### PIP On/Off

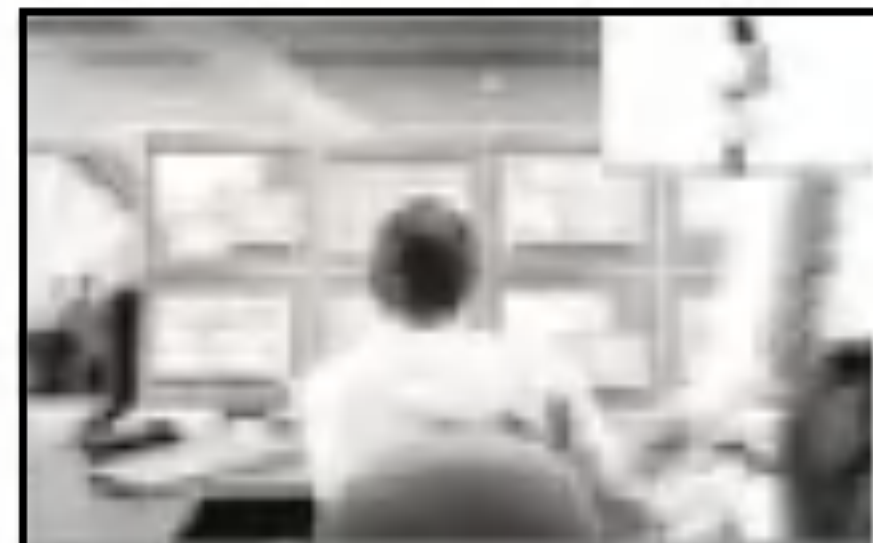

After selecting **PIP** in the **PIP On/Off** menu, the following menu items can be adjusted.

**PIP Source** To select an input signal for PIP.

**PIP Size** To adjust the size of the PIP screen. (Small, Large)

**PIP Position** Adjust the PIP screen position.

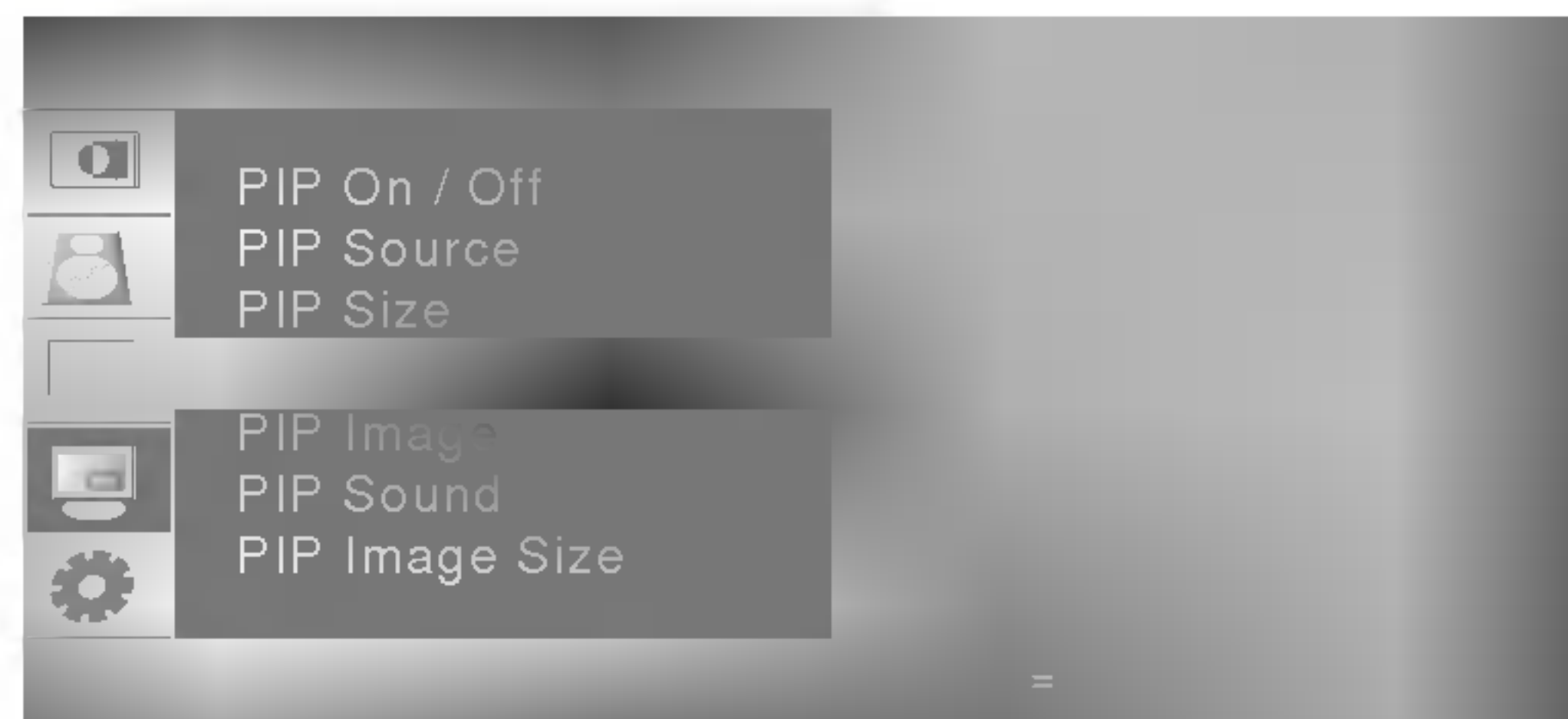

**PIP Image** To adjust the image of the PIP screen; Press the **▶** button to display the submenu for **PIP IMAGE**. Select submenu and Press the 'SET' button. Use the **◀ ▶** buttons to adjust the item to the desired level. The items of the sub-menu may vary depending on the type of the source.

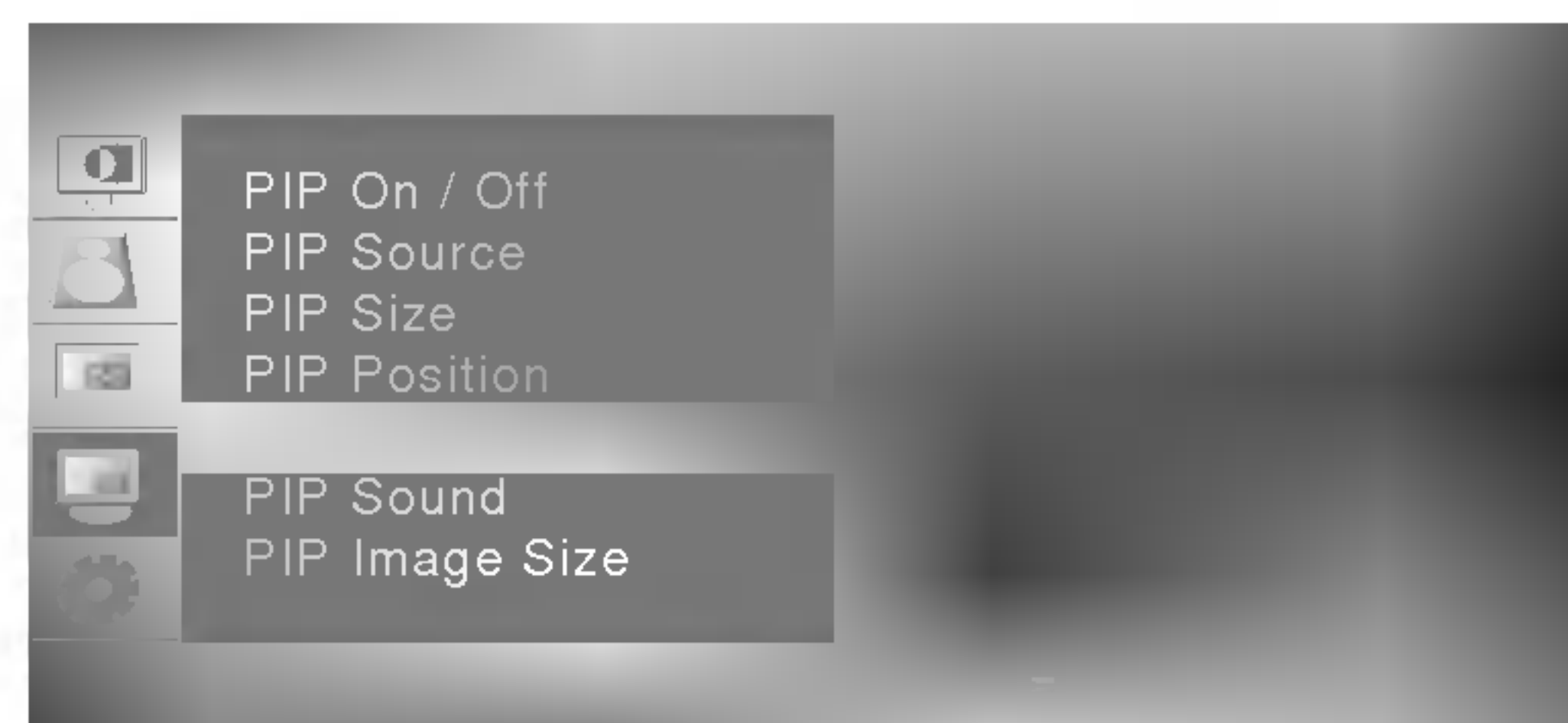

- **PIP Brightness**  
Adjust PIP screen brightness.
- **PIP Contrast**  
Adjust PIP screen contrast.
- **PIP Colour**  
Adjust the PIP screen colour.
- **PIP Sharpness**  
Adjust the PIP screen sharpness.

**PIP Sound** To turn the PIP sound on/off.

**PIP Image Size** To select the image size of the screen. (FULL, 4:3, 16:9, ZOOM )

---

## Selecting the options

---



- Language** To choose the language in which the control names are displayed.
- Input** If you press the button once, the following Input Signal Window will appear. Select the signal type you want using the ▼▲ button.
- Child Lock** Use the ▼▲ buttons to select ON or OFF. The monitor can be set up so that it can only be used with the remote control. This feature can prevent unauthorized viewing.  
In order to lock the OSD screen adjustment, set the Child Lock tab to the 'on' position.  
In order to unlock it, do the following :  
Push the menu button on the remote control and set Child Lock to the 'off' position.
- Image Size** To select the image size of the screen. (FULL, 4:3, 16:9, ZOOM)  
(It is not adjustable to the D-Sub, DVI, AV1-COMPONENT Input source.)
- Power Indicator** Use this function to set the power indicator on the front side of the monitor to **ON** or **OFF**.  
If you set **OFF**, it will go off after 15 seconds. If you set **ON** at any time, the power indicator will automatically be turned on.
- Reset** Use this function to reset the monitor to the factory default. However, language selection will not be initialized.
- 





## ■■■ OSD Menu – When Watching Video/ DVD

### Adjusting Screen Colour

PSM

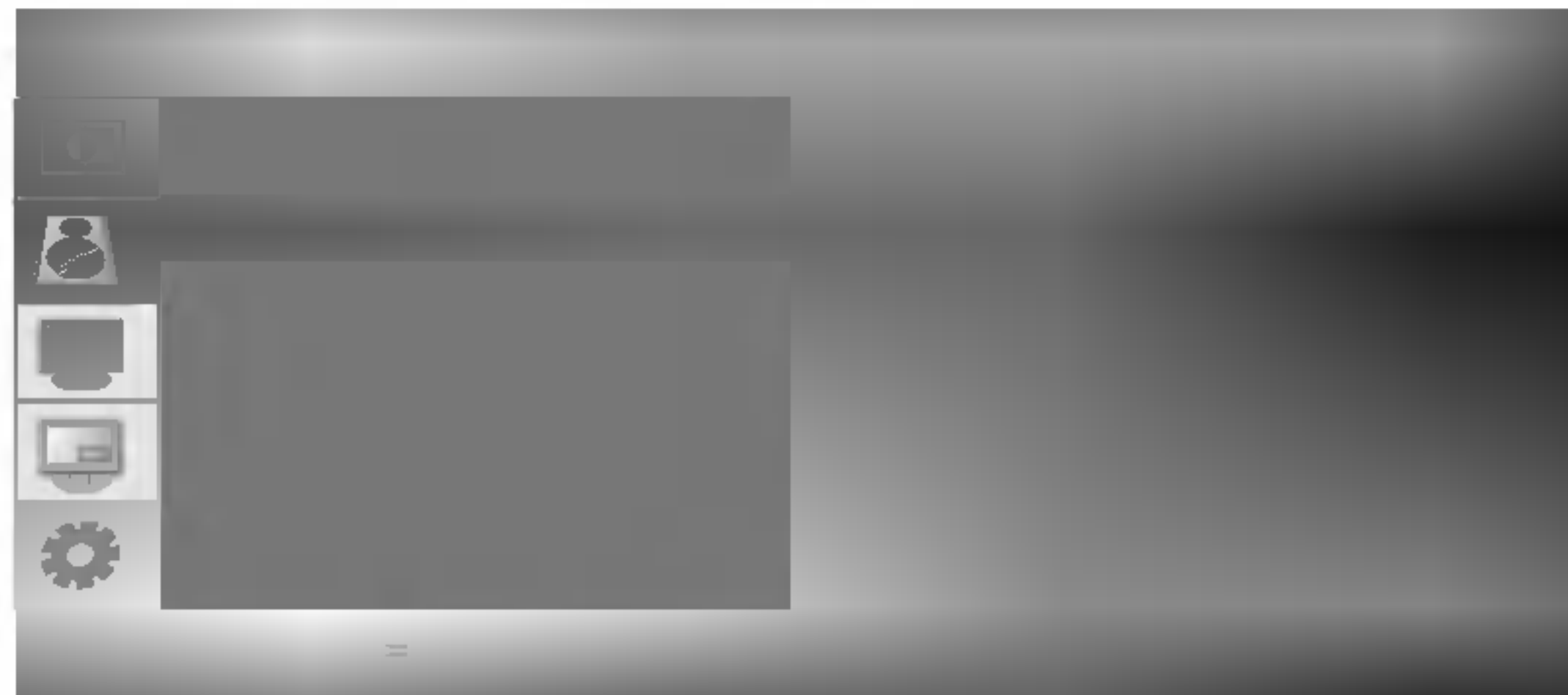

The PSM function automatically adjusts the screen image quality depending on the AV usage environment.

- **Dynamic** : Select this option to display with a sharp image.
- **Standard** : The most general and natural screen display status.
- **Mild** : Select this option to display with a mild image.
- **Game** : Select this option to enjoy dynamic image when playing a game.
- **User** : Select this option to use the user-defined settings.



- Brightness** To adjust the brightness of the screen.
- Contrast** To adjust the contrast of the screen.
- Colour** To adjust the colour to desired level.
- Sharpness** To adjust the clearness of the screen.



#### Note

If the 'PSM' setting in the Picture menu is set to Dynamic, Standard, Mild or Game the subsequent menus will be automatically set.



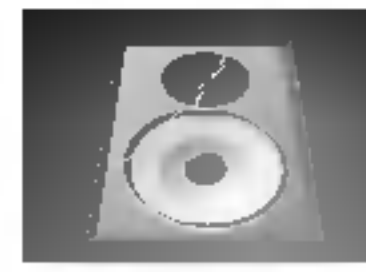

## Adjusting the audio function

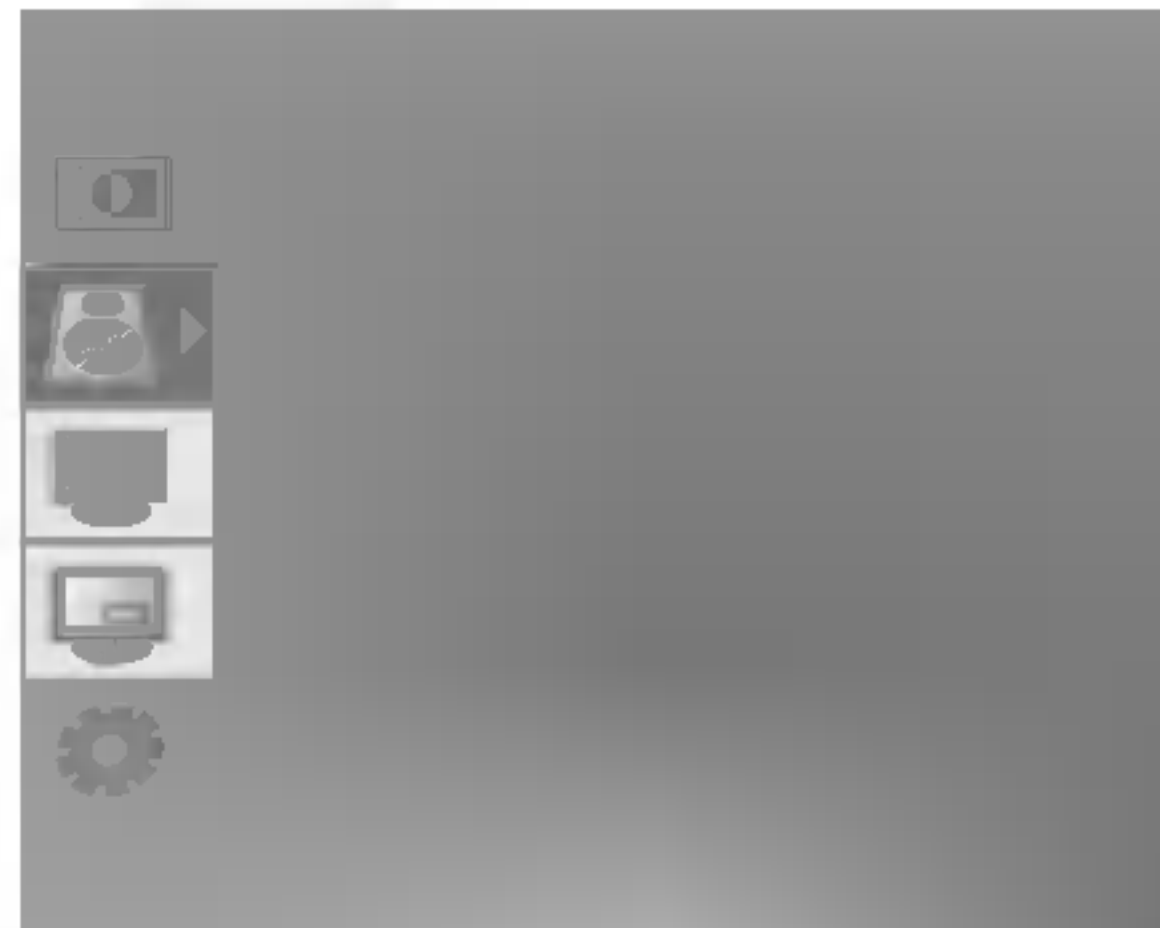

SSM

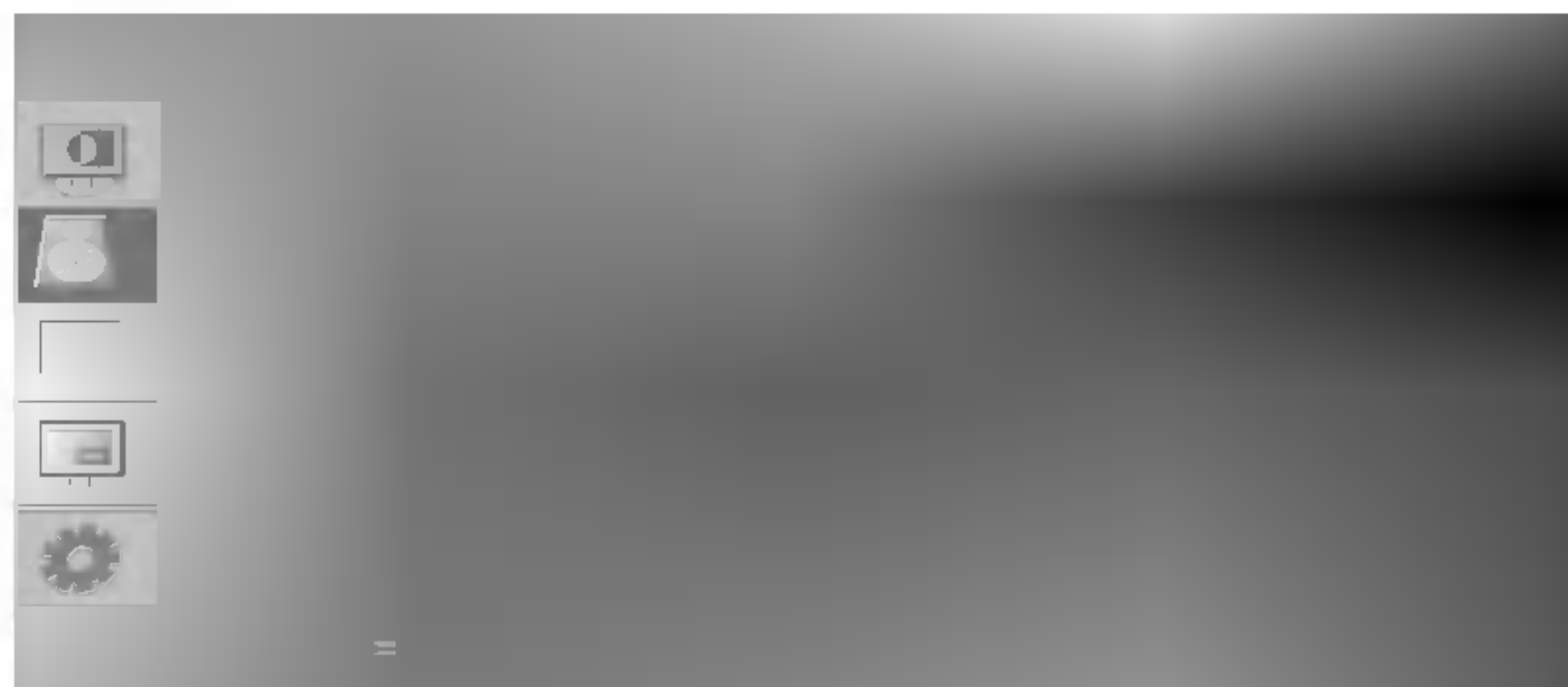

The best sound tone quality will be selected automatically depending on the video type that you're currently watching.

- **Flat** : The most commanding and natural audio.
- **Music** : Select this option to enjoy the original sound when listening to the music.
- **Movie** : Select this option to enjoy sublime sound.
- **Speech** : Select this option to watch sports broadcasting.
- **User** : Select this option to use the user-defined audio settings.

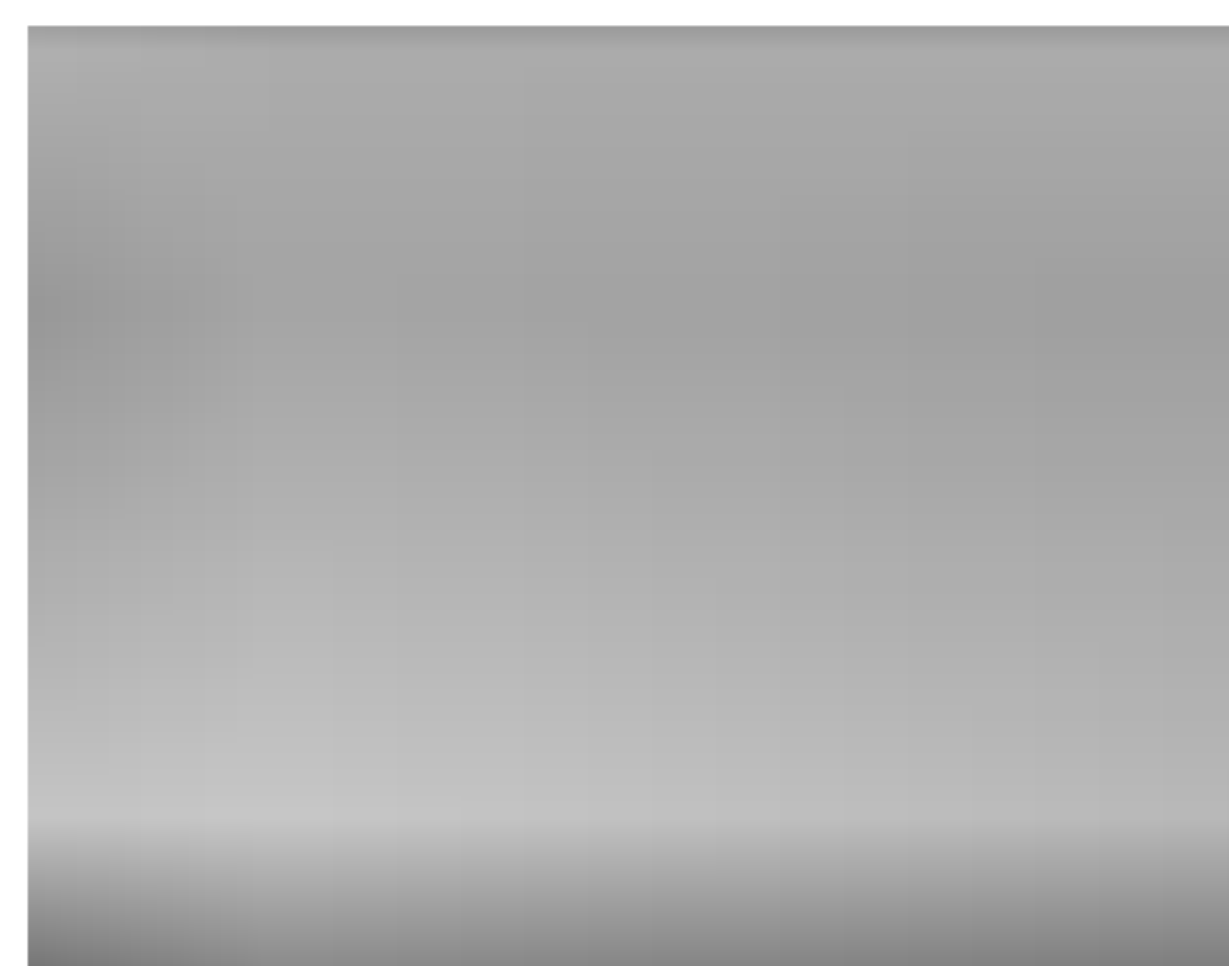

**Balance** Use this function to balance sound from the left and right speakers.

**SRS WOW** Set the SRS WOW menu on.  
The SRS WOW function plays back the mono or stereo sound input with the dynamic surround effects. It will provide rich and profound sound tone. If you set the SRS WOW on, User audio setting can not be adjusted.



**Note** When connected to your computer and the 'SSM' setting in the audio menu is one of Flat, Movie, Music or Speech, the available menus are Balance and SRS WOW .



## Adjusting PIP Mode (Multiple Screen) Functions (AVI-COMPONENT)

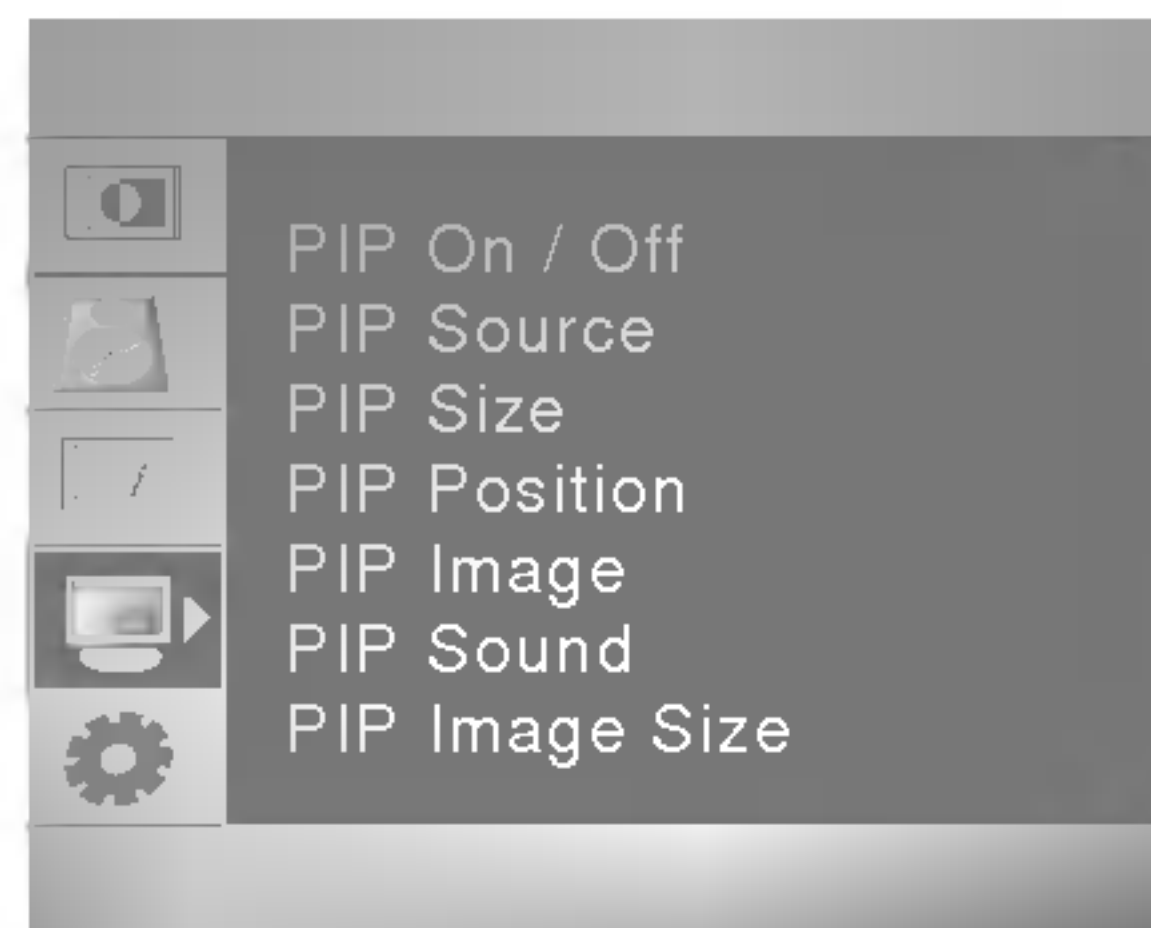

### PIP On/Off

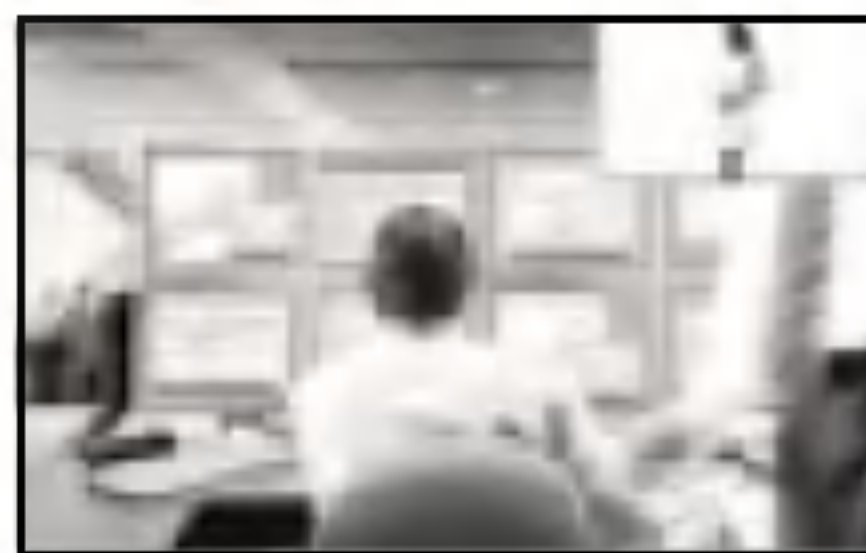

After selecting **PIP** in the **PIP On/Off** menu, the following menu items can be adjusted.

**PIP Source** To select an input signal for PIP.

**PIP Size** To adjust the size of the PIP screen. (Small, Large)

**PIP Position** Adjust the PIP screen position.

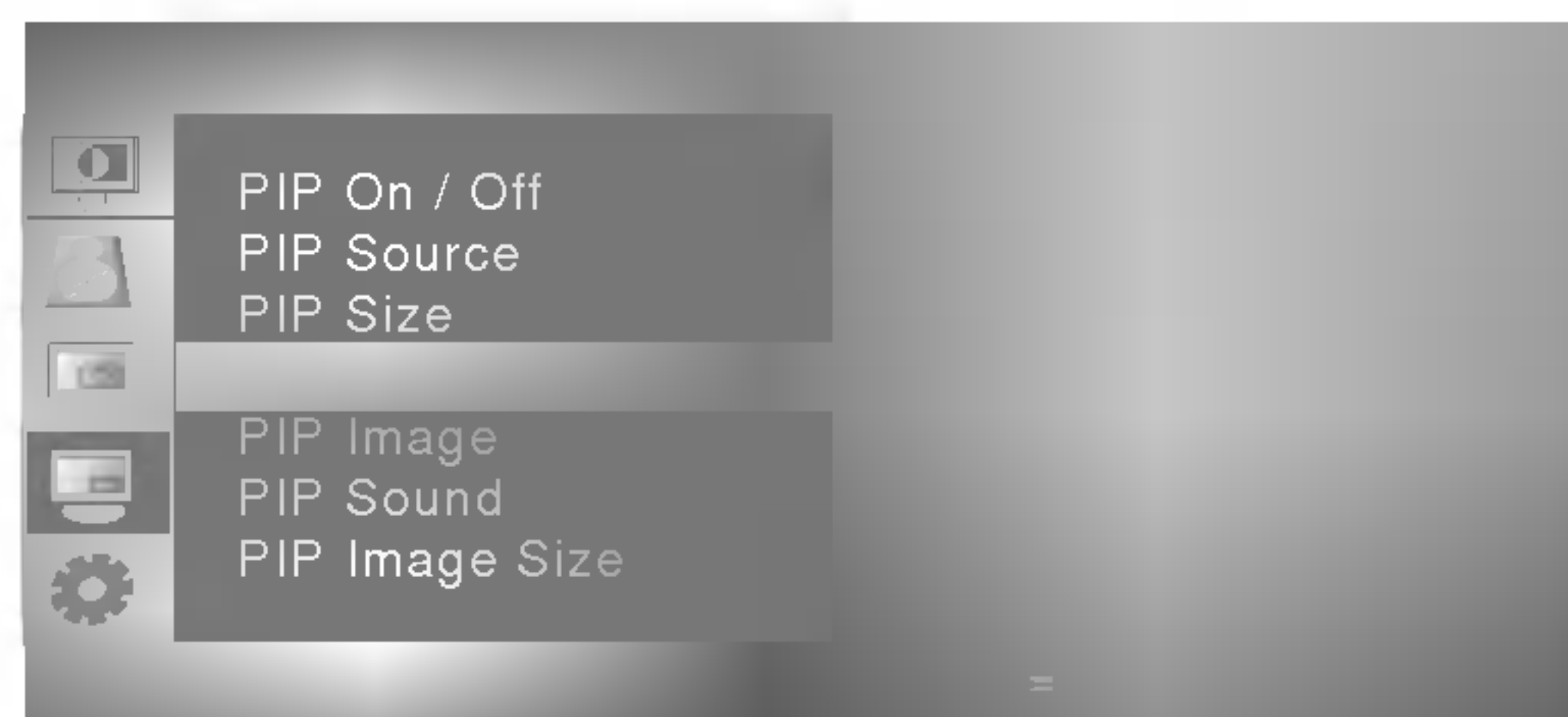

**PIP Image** To adjust the image of the PIP screen; Press the ► button to display the submenu for PIP IMAGE. Select submenu and Press the 'SET' button. Use the ◀ ► buttons to adjust the item to the desired level. The items of the sub-menu may vary depending on the type of the source.

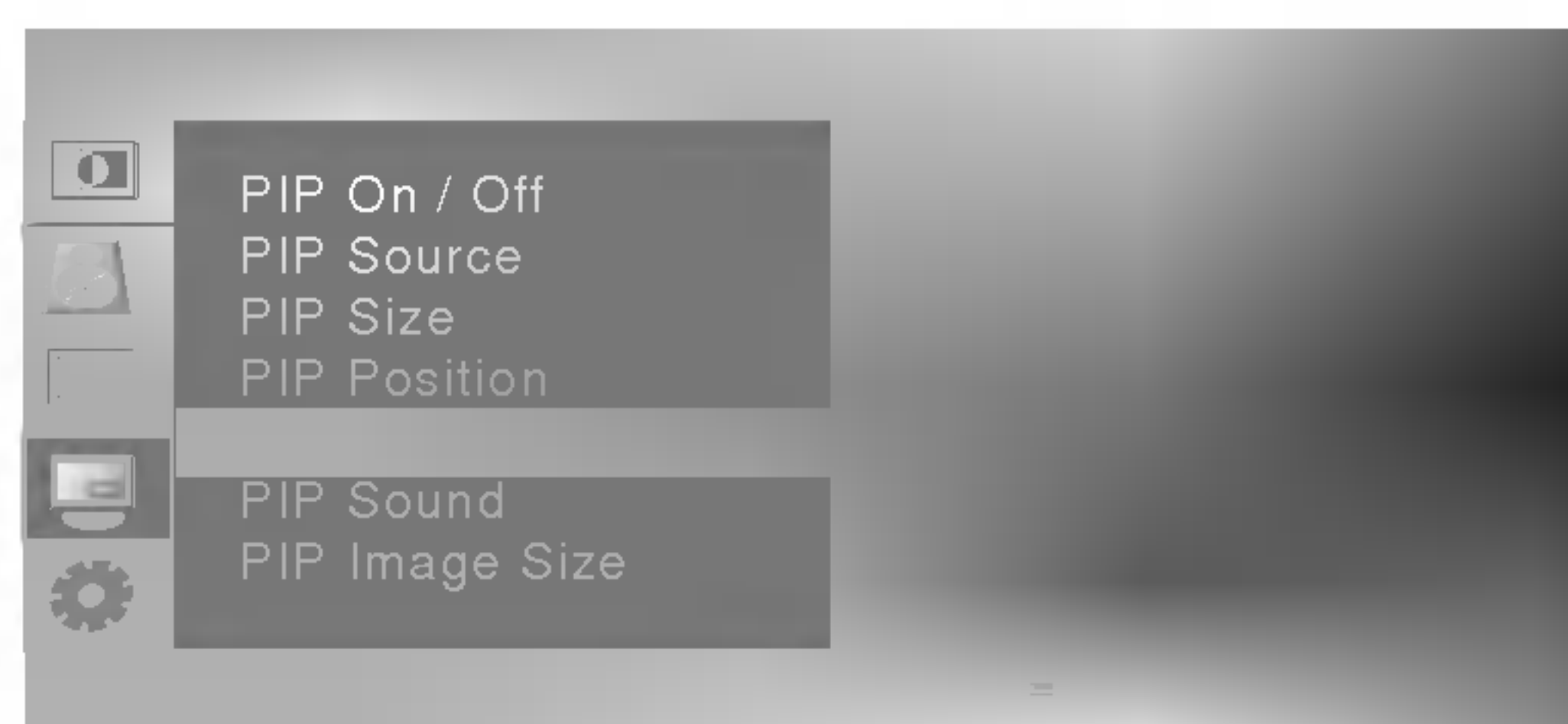

- **PIP Brightness**  
Adjust PIP screen brightness.
- **PIP Contrast**  
Adjust PIP screen contrast.
- **PIP Colour**  
Adjust the PIP screen colour.
- **PIP Sharpness**  
Adjust the PIP screen sharpness.

**PIP Sound** To turn the PIP sound on/off.

**PIP Image Size** To select the image size of the screen. (FULL, 4:3, 16:9, ZOOM )

---

## Selecting the options

---

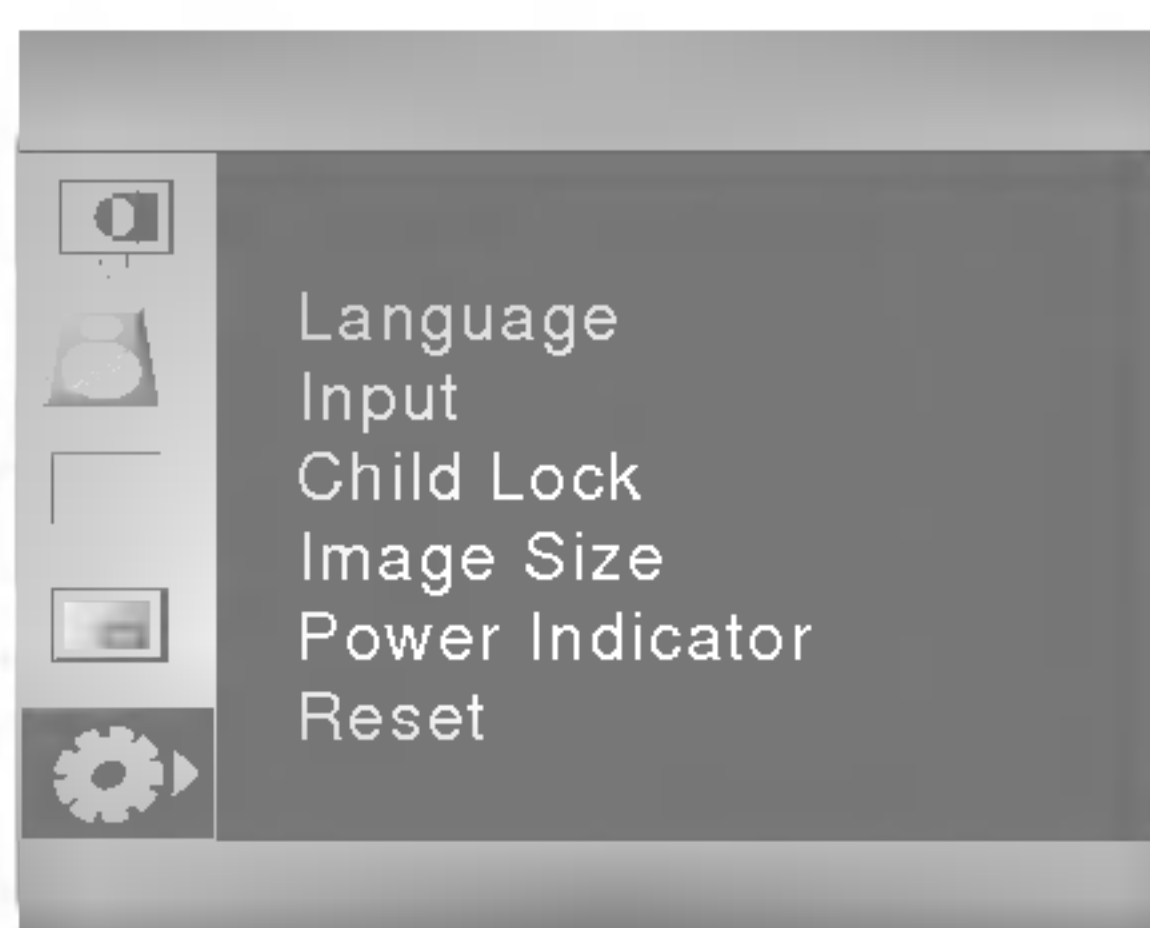

- Language** To choose the language in which the control names are displayed.
- Input** If you press the button once, the following Input Signal Window will appear. Select the signal type you want using the ▼▲ button.
- Child Lock** Use the ▼▲ buttons to select ON or OFF. The monitor can be set up so that it can only be used with the remote control. This feature can prevent unauthorized viewing.  
In order to lock the OSD screen adjustment, set the Child Lock tab to the 'on' position.  
In order to unlock it, do the following :  
Push the menu button on the remote control and set Child Lock to the 'off' position.
- Image Size** To select the image size of the screen. (FULL, 4:3, 16:9, ZOOM)
- Power Indicator** Use this function to set the power indicator on the front side of the monitor to **ON** or **OFF**.  
If you set **OFF**, it will go off after 15 seconds. If you set **ON** at any time, the power indicator will automatically be turned on.
- Reset** Use this function to reset the monitor to the factory default. However, language selection will not be initialized.
- 
- 

- Is the monitor power cord connected?
- Does the power LED is turned on?
- Power is on, power LED is blue but the screen appears extremely dark.
- Does the power LED look amber?
- Does the 'OUT OF RANGE' message appear?
- Does the 'CHECK SIGNAL CABLE' message appear?

- See if the power cord is properly connected to the outlet.
- See if the power switch is turned on.
- Adjust brightness and contrast again.
- If the monitor is in power saving mode, move the mouse or press any key.
- The signal from the PC (video card) is out of the vertical or horizontal frequency range of the monitor. Adjust the frequency range by referring to the Specifications in this manual.
  - \* **Maximum resolution**
  - DSUB : 1280x1024 @75Hz
  - DVI-D : 1280x1024 @60Hz
- The signal cable between PC and monitor is not connected. Check the signal cable.
- Press the 'SOURCE' menu in the remote controller to check the input signal.

- Did you install the driver?

- Install the monitor driver, which is provided with the monitor, or download it from the web site. (<http://www.lge.com>)
- See if the plug&play function is supported by referring to the video card user manual.



**Note**

- \* **Vertical frequency:** To enable the user to watch the monitor display, screen image should be changed tens of times every second like a fluorescent lamp. The vertical frequency or refresh rate is the times of image display per second. The unit is Hz.
- \* **Horizontal frequency:** The horizontal interval is the time to display one vertical line. When 1 is divided by the horizontal interval, the number of horizontal lines displayed every second can be tabulated as the horizontal frequency. The unit is kHz.





# Troubleshooting

## The screen image looks abnormal.

● **Is the screen position wrong?**

- DSUB analogue signal – Press the “AUTO” button in the remote controller to automatically select the optimal screen status that fits into the current mode. If adjustment is not satisfactory, use the Position OSD menu.
- See if the video card resolution and frequency are supported by the monitor. If the frequency is out of range, set to the recommended resolution in the Control Panel – Display – Setting menu.

● **Do thin lines appear on the background screen?**

- DSUB analogue signal – Press the “AUTO” button in the remote controller to automatically select an optimal screen status that fits into the current mode. If adjustment is not satisfactory, use the Clock OSD menu.

● **Horizontal noise appears or the characters look blurred.**

- DSUB analogue signal – Press the “AUTO” button in the remote controller to automatically select an optimal screen status that fits into the current mode. If adjustment is not satisfactory, use the Phase OSD menu.

## The audio function does not work.

● **No sound?**

- See if the audio cable is connected properly.
- Adjust the volume.
- See if the sound is set properly.

● **No sound is available when the PIP mode is engaged.**

- See if the Sound is set to On in the PIP menu.

● **Sound is too dull.**

- Select the appropriate equalize sound.

● **Sound is too low.**

- Adjust the volume.

### 'CHILD LOCK' message appears

- The 'CHILD LOCK' message appears when pressing the Menu button.

- Use the ▼▲ buttons to select ON or OFF. The monitor can be set up so that it can only be used with the remote control. This feature can prevent unauthorized viewing.  
In order to lock the OSD screen adjustment, set the Child Lock tab to the 'on' position.  
In order to unlock it, do the following :  
1) Push the menu button on the remote control and set Child Lock to the 'off' position.  
2) Simultaneously push the menu button on the right of the monitor and the '+' button for 5 seconds.

### Screen colour is abnormal.

- Screen has poor colour resolution (16 colors).

- Set the number of colors to more than 24 bits (true colour)  
Select Control Panel – Display – Settings – Colour Table menu in Windows.

- Screen colour is unstable or mono-colored.

- Check the connection status of the signal cable.  
Or, re-insert the PC video card.

- Do black spots appear on the screen?

- Several pixels (red, green, white or black colour) may appear on the screen, which can be attributable to the unique characteristics of the LCD panel. It is not a malfunction of the LCD.

### After-image appears on the monitor.

- After-image appears when the monitor is turned off.

- If you use a fixed image for a long time, the pixels may be damaged quickly. Use the screensaver function.

## [17inches]

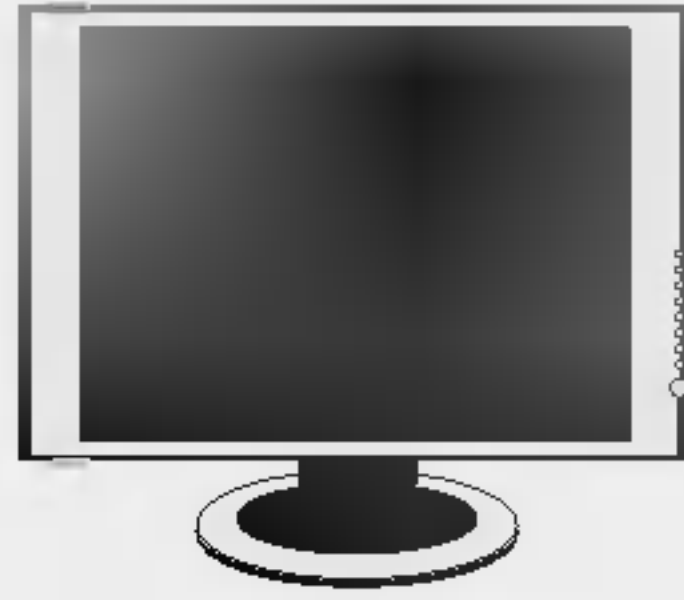
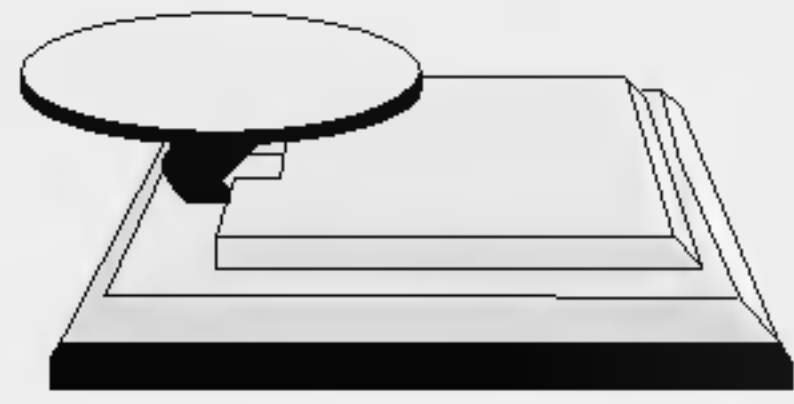
<b>LCD Panel</b>	<b>Screen Type</b>	17 inches (432.7mm) TFT (Thin Film Transistor) LCD (Liquid Crystal Display) Panel Visible diagonal size: 432.7mm
	<b>Pixel Pitch</b>	0.264mm
<b>Video Signal</b>	<b>Max. Resolution</b>	D-SUB :1280X1024 @75Hz DVI-D : 1280X1024 @60Hz
	<b>Recommended Resolution</b>	D-SUB : SXGA 1280X1024 @60Hz DVI-D : SXGA 1280X1024 @60Hz
	<b>Horizontal Frequency</b>	D-SUB : 30 - 83 kHz DVI-D : 30 - 71 kHz
	<b>Vertical Frequency</b>	56 - 75 Hz
	<b>Synchronization Type</b>	Separate/Composite/SOG (Sync On Green)/Digital
<b>Input Connector</b>		15-pin D-Sub type, DVI-D (digital), S-Video, Composite Video, Component
<b>Power</b>	<b>Rated Voltage</b>	AC 100-240V~ 50/60Hz 1.0A
	<b>Power Consumption</b>	On Mode : 55W Sleep Mode : ≤ 2W Off Mode : ≤ 2W
<b>Tilt</b>	<b>Tilt Range</b>	-5° ~25°
	<b>Tilt Stand</b>	Attached
<b>Dimension/Weight</b>	<b>Size (WxLxH)</b>	 474.5mm x 242.0 mm x 401.7mm
		 474.5mm x 115.2 mm x 447.7mm
	<b>Weight (excl. package)</b>	6.84 kg (15.0 lbs)
<b>Environmental Conditions</b>	<b>Operational Condition</b>	Temperature: 10°C ~ 35°C , Humidity: 10% ~ 80%
	<b>Storage Condition</b>	Temperature: -20°C ~ 60°C , Humidity: 5% ~ 95%

## [19inches]

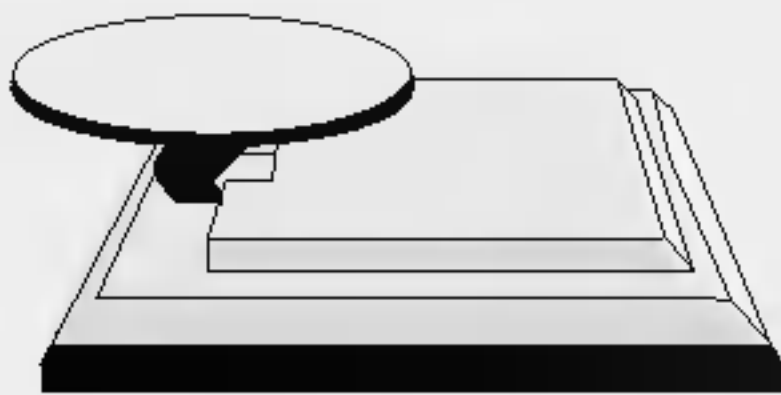
<b>LCD Panel</b>	<b>Screen Type</b>	19 inches (481.84mm) TFT (Thin Film Transistor) LCD (Liquid Crystal Display) Panel Visible diagonal size: 481.84mm
	<b>Pixel Pitch</b>	0.294mm
<b>Video Signal</b>	<b>Max. Resolution</b>	D-SUB : 1280X1024 @75Hz DVI-D : 1280X1024 @60Hz
	<b>Recommended Resolution</b>	D-SUB : SXGA 1280X1024 @60Hz DVI-D : SXGA 1280X1024 @60Hz
	<b>Horizontal Frequency</b>	D-SUB : 30 - 83 kHz DVI-D : 30 - 71 kHz
	<b>Vertical Frequency</b>	56 - 75 Hz
	<b>Synchronization Type</b>	Separate/Composite/SOG (Sync On Green)/Digital
<b>Input Connector</b>	15-pin D-Sub type, DVI-D (digital), S-Video, Composite Video, Component	
<b>Power</b>	<b>Rated Voltage</b>	AC 100-240V~ 50/60Hz 1.0A
	<b>Power Consumption</b>	On Mode : 55W Sleep Mode : ≤ 2W Off Mode : ≤ 2W
<b>Tilt</b>	<b>Tilt Range</b>	-5°~25°
	<b>Tilt Stand</b>	Attached
<b>Dimension/Weight</b>	<b>Size (WxLxH)</b>	 517.0mm x 242.0mm x 436.0mm
		 517.0mm x 119.2mm x 481.7mm
	<b>Weight (excl. package)</b>	7.96 kg (17.5 lbs)
<b>Environmental Conditions</b>	<b>Operational Condition</b>	Temperature: 10°C ~ 35°C , Humidity: 10% ~ 80%
	<b>Storage Condition</b>	Temperature: -20°C ~ 60°C , Humidity: 5% ~ 95%

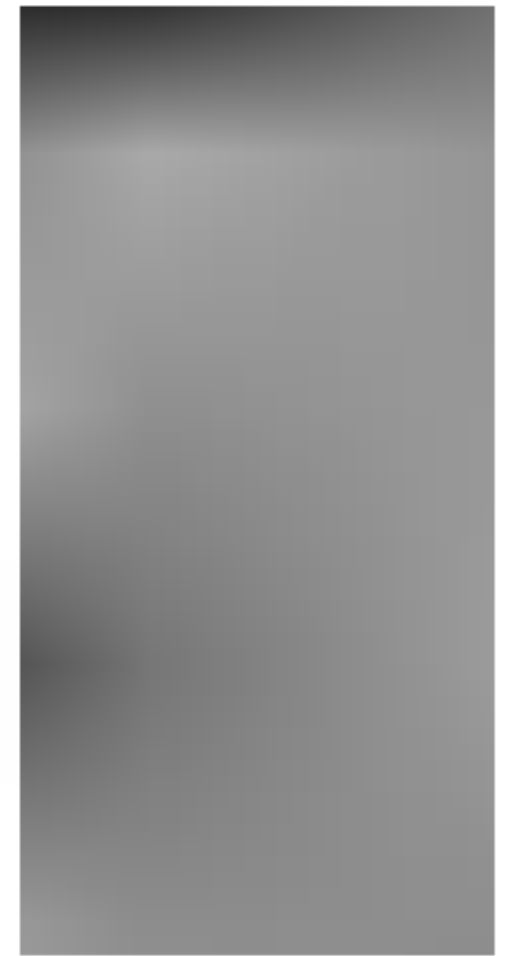

**● PC Mode – Preset Mode**

1	VGA	640 x 350	31.469	70	8	VESA 1024 x 768	48.363	60
2	VESA	720 x 400	31.468	70	9	VESA 1024 x 768	60.123	75
3	VGA	640 x 480	31.469	60	10	MAC 1152 x 870	68.681	75
4	VESA	640 x 480	37.500	75	11	SUN 1152 x 900	61.805	65
5	VESA	800 x 600	37.879	60	12	VESA 1280 x 1024	63.981	60
6	VESA	800 x 600	46.875	75	13	VESA 1280 x 1024	79.976	75
7	MAC	832 x 624	49.725	75				

**● Power LED**

On Mode	Blue
Sleep Mode	Amber
Off Mode	Off

**VESA wall mounting**

Connected to another object (stand type and wall-mounted type. This monitor accepts a VESA-compliant mounting interface pad.-optional)

Refer to the [VESA Mounting Guide](#).

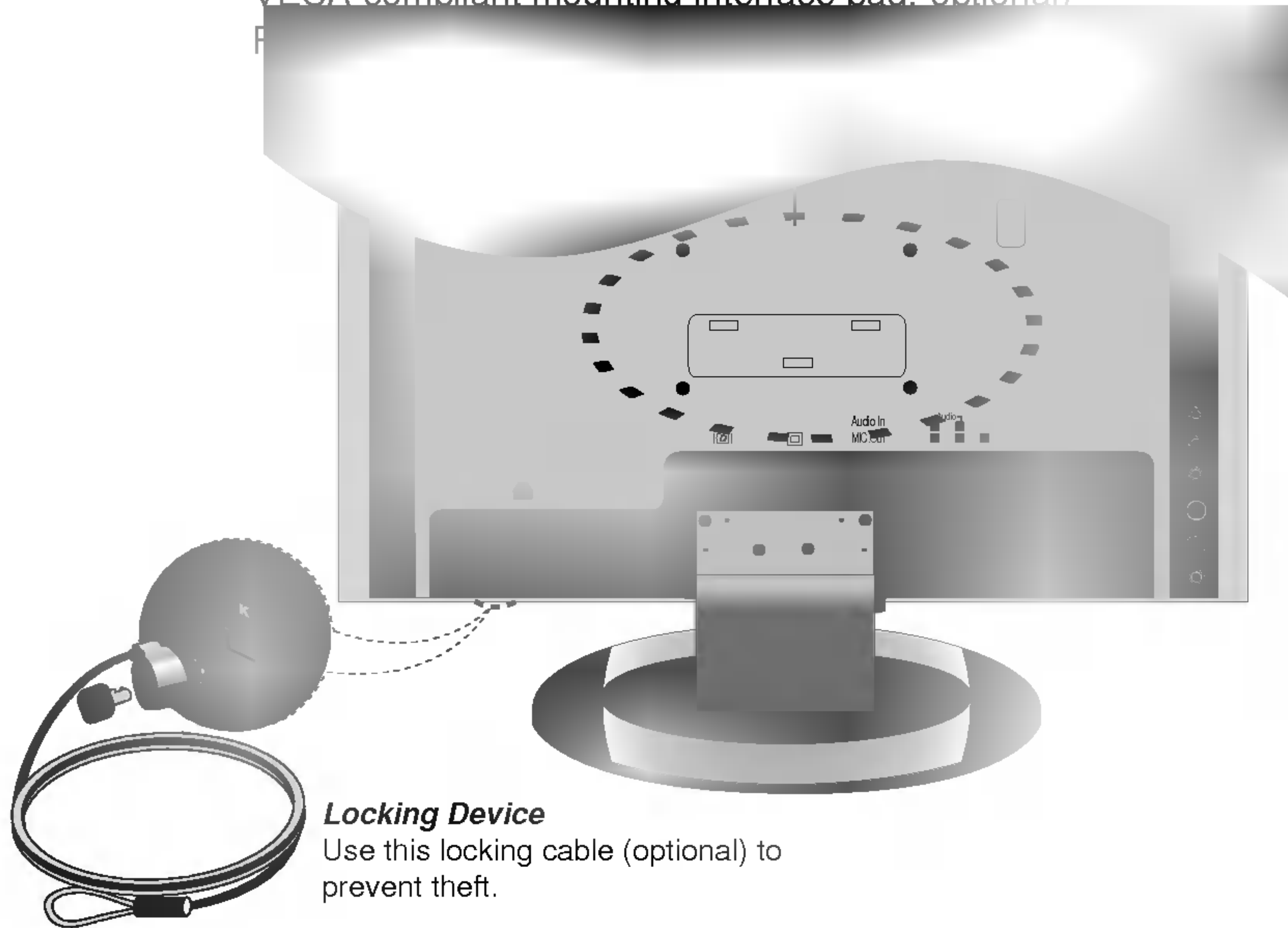

**Locking Device**  
Use this locking cable (optional) to prevent theft.





## DVI-D

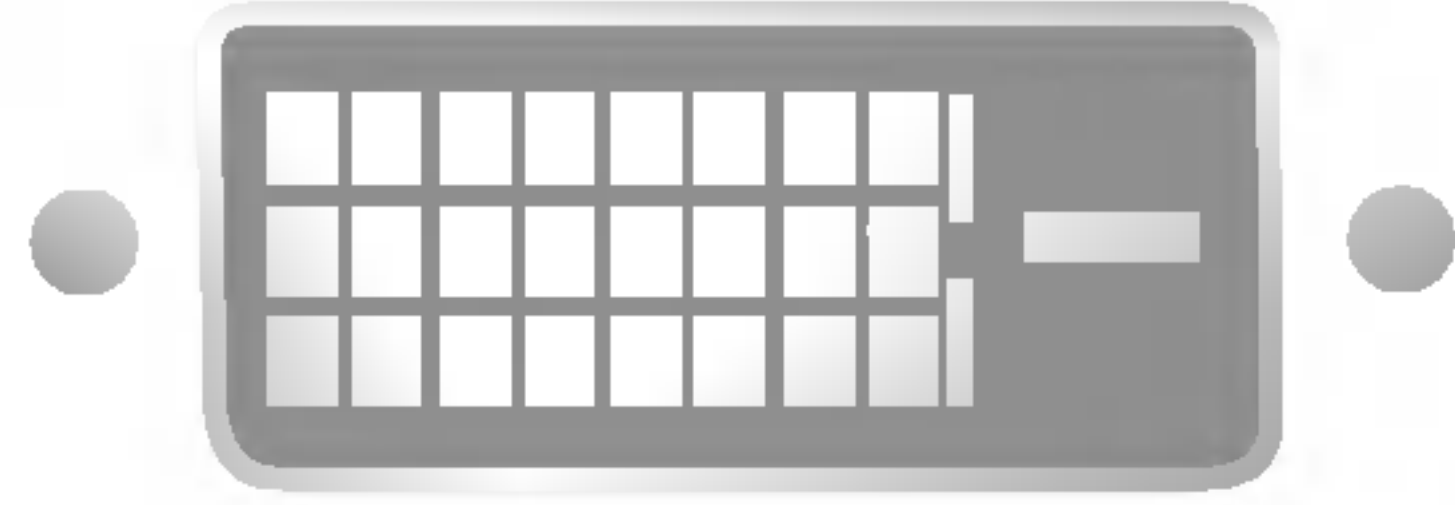

1	T. M. D. S. Data 2-
2	T. M. D. S. Data 2+
3	T. M. D. S. Data 2/4 Shield
4	T. M. D. S. Data 4-
5	T. M. D. S. Data 4+
6	DDC Clock
7	DDC Data
8	Analogue Vertical Synchronization
9	T. M. D. S. Data 1-
10	T. M. D. S. Data 1+
11	T. M. D. S. Data 1/3 Shield
12	T. M. D. S. Data 3-
13	T. M. D. S. Data 3+
14	+5V Power
15	Grounding (return for +5V, horizontal sync and vertical sync)
16	Hot Plug Detect
17	T. M. D. S. Data 0-
18	T. M. D. S. Data 0+
19	T. M. D. S. Data 0/5 Shield
20	T. M. D. S. Data 5-
21	T. M. D. S. Data 5+
22	T. M. D. S. Clock Shield
23	T. M. D. S. Clock+
24	T. M. D. S. Clock

T.M.D.S. (Transition Minimized Differential Signaling)