



PLASMA MONITOR OWNER'S MANUAL

Please read this manual carefully before operating your set.
Retain it for future reference.
Record model number and serial number of the set.
See the label attached on the back cover and quote this information to your dealer when you require service.

Model number :
Serial number :

Safety Instructions

- It is recommended that 42/50PM1MH / 60PZ9MH / 42PM3MVH model only be used at an altitude of less than 6561 feet (2000m) to get the best quality picture and sound.

WARNING

Do not place the set in direct sunlight or near heat sources such as heat registers, stove and so on.

- This may cause a fire.

Do not use the set in damp place such as a bathroom or any place where it is likely to get wet.

- This may cause a fire or could give an electric shock.

Bend antenna cable between inside and outside building to prevent rain from flowing in.

- This may cause water damaged inside the set and could give an electric shock.

Earth wire should be connected.

- If the earth wire is not connected, there is possible a danger of electric shock caused by the current leakage.
- If grounding methods are not possible, a separate circuit breaker should be employed and installed by a qualified electrician.

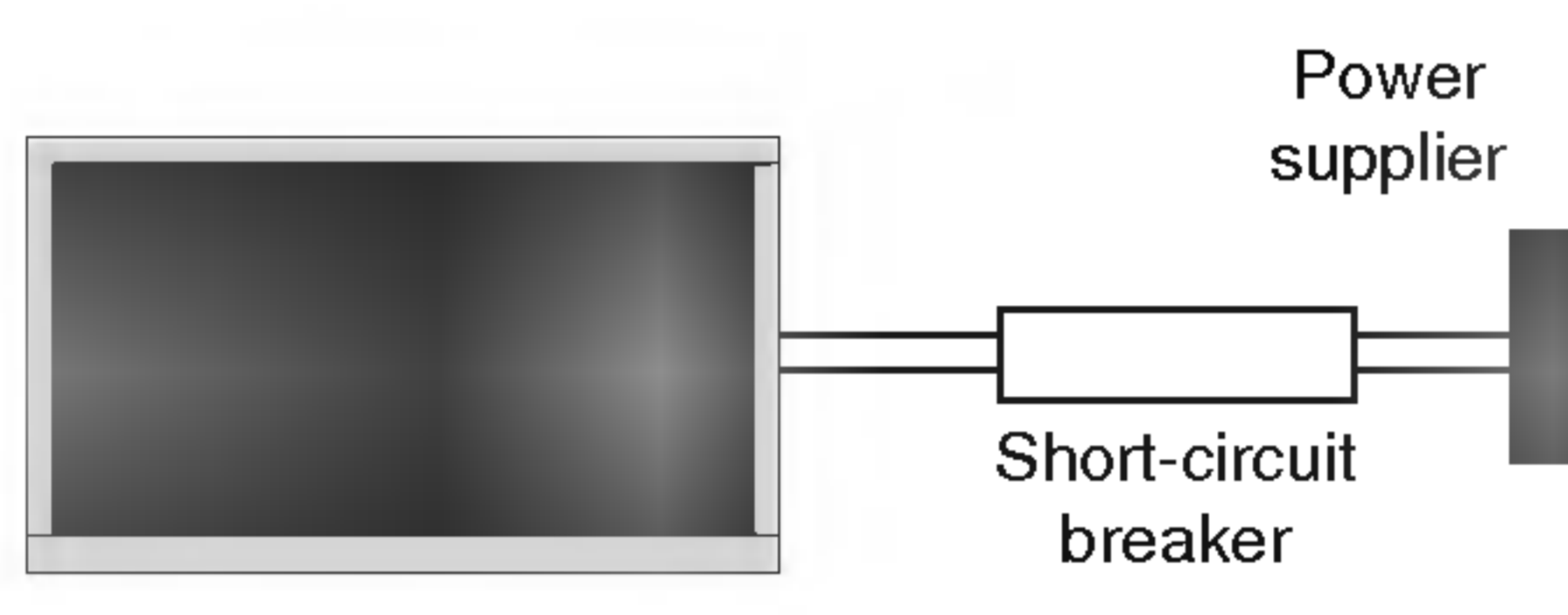

- Do not connect ground to telephone wires, lightning rods or gas pipe.

Apparatus shall not be exposed to dripping or splashing and no objects filled with liquids, such as vases, shall be placed on the apparatus.

Do not insert any object into the exhaust vent.

- This may cause a fire or could give an electric shock.

Do not place heavy objects on the set.

- This may cause serious injury to a child or adult.

Do not use water while cleaning the set.

- This may cause damaged the set or could give an electric shock.

In case of smoke or strange smell from the set, switch it off ,unplug it from the wall outlet and contact your dealer or service center.

- This may cause a fire or could give an electric shock.

Do not attempt to service the set yourself. Contact your dealer or service center.

- This may cause damaged the set or could give an electric shock.

During a lightning thunder, unplug the set from the wall outlet and don't touch an antenna cable.

- This may cause damaged the set or could give an electric shock.

DISCONNECTING DEVICE FROM MAINS

- Mains plug is the disconnecting device. The plug must remain readily operable.

Use a dedicated power cord. Do not modify or extend the power cord.

Do not install, remove, or reinstall the unit by yourself (customer).

For electrical work, contact the dealer, seller, a qualified electrician, or an Authorized Service Center. For installation, always contact the dealer or an Authorized Service Center.

Do not use if the power cord or plug is damaged, or socket is loose. Use a dedicated outlet for this appliance.

Do not over bend the power cord and do not place anything on the power cord. Do not install the monitor near any sharp edge to avoid wire damage.

WARNING in U.K. only

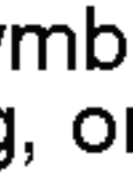
- * This set is supplied with a BS 1363 approved 13 amp mains plug, fused at 13 amp. When replacing the fuse always use a 13 amp BS 1362, BSI or ASTA approved type. Never use this plug with the fuse cover omitted. To obtain a replacement fuse cover contact your dealer or "LG Electronics U.K. Ltd." If the type of plug supplied is not suitable for the mains sockets in your home, then the plug should be removed and a suitable type fitted. A mains plug removed from the mains lead of this set must be destroyed. A mains plug with bared wires is hazardous if inserted in a mains socket. Do not connect either wire to the earth pin, marked with the letter E or with the earth symbol  or coloured green or green and yellow. If any other plug is fitted, use a 13 amp fuse, either in the plug, or at the distribution board. The wires in this mains lead are coloured in accordance with the following codes: BLUE: NEUTRAL, BROWN: LIVE. As the colours of the wires in the mains lead of this set may not correspond with the coloured marking identifying the terminals in your plug, proceed as follows: The wire which is coloured blue must be connected to the terminal which is marked with the letter N or coloured black. The wire which is coloured brown must be connected to the terminal which is marked with the letter L or coloured red.

* Safety instructions have two kinds of information, and each meaning of it is as below.

⚠ WARNING The violation of this instruction may cause serious injuries and even death.

⚠ NOTES The violation of this instruction may cause light injuries or damage of the product.

⚠ Take care of danger that may happen under specific condition.

⚠ NOTES

Never touch the power plug with a wet hand.

- This may cause an electric shock.

Disconnect from the mains and remove all connections before moving.

Do not place the set in a built-in installation such as a bookcase or rack.

- Ventilation required.

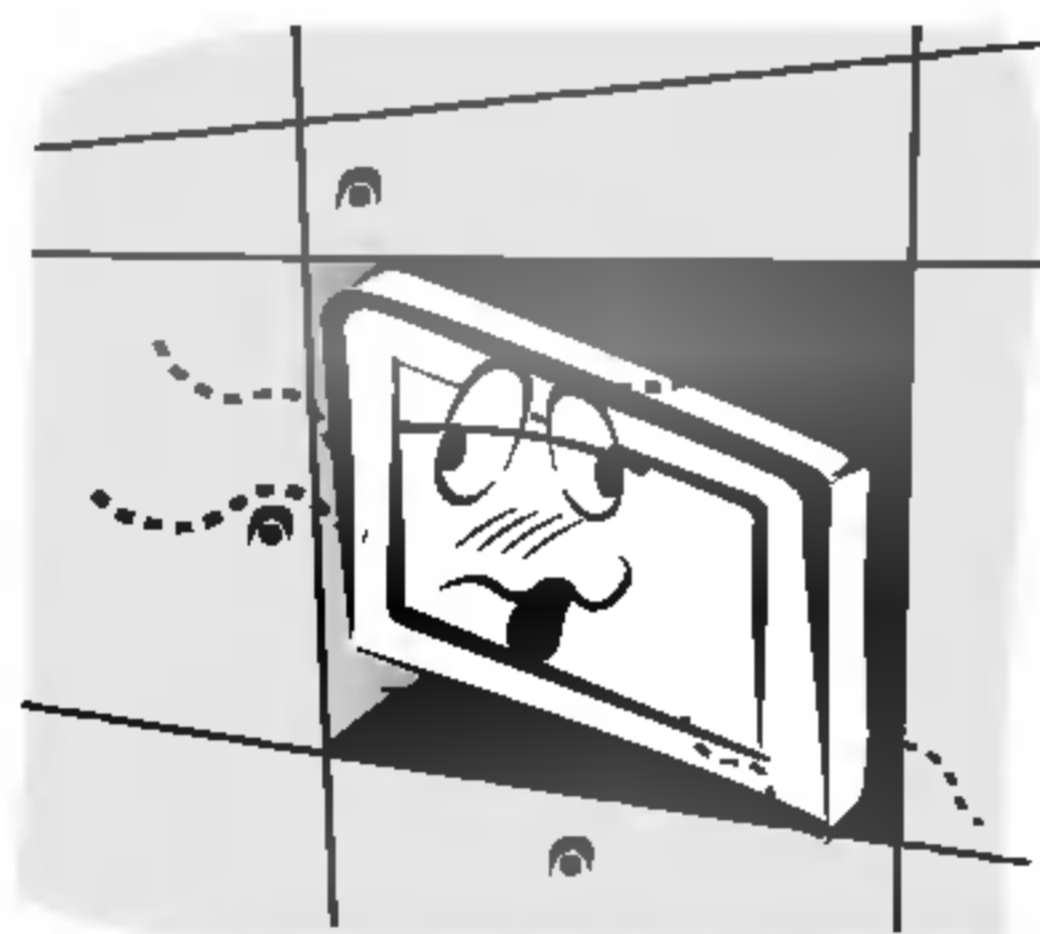

When installing the set on a table, be careful not to place the edge of its stand.

- This may cause the set to fall, causing serious injury to a child or adult, and serious damage to the set.



Do not place an outside antenna in the vicinity of overhead power lines or other electric light or power circuits.

- This may cause an electric shock.

There should be enough distance between an outside antenna and power lines to keep the former from touching the latter even when the antenna falls.

- This may cause an electric shock.

Do not pull the cord but the plug when unplugging.

- This may cause a fire.

Ensure the power cord doesn't trail across any hot objects like a heater.

- This may cause a fire or an electric shock.

Do not plug when the power cord or the plug is damaged or the connecting part of the power outlet is loose.

- This may cause a fire or an electric shock.

Dispose of used batteries carefully to protect a child from eating them.

- In case that it eats them, take it to see a doctor immediately.

When moving the set assembled with speakers do not carry holding the speakers.

- This may cause the set to fall, causing serious injury to a child or adult, and serious damage to the set.

Unplug this product from the wall outlet before cleaning. Do not use liquid cleaners or aerosol cleaners.

- This may cause damaged the set or could give an electric shock.

Contact the service center once a year to clean the internal part of the set.

- Accumulated dust can cause mechanical failure.

The distance between eyes and the screen should be about 5 ~ 7 times as long as diagonal length of the screen.

- If not, eyes will strain.

Unplug the set from the wall outlet when it is left unattended and unused for long periods of time or occurred a state of emergency.

- Accumulated dust may cause a fire or an electric shock from deterioration or electric leakage.

Contents

Safety Warnings		Time Menu Options	
Safety Instructions	2~3	Setting the Clock	23
Introduction		Setting the On/Off Timer	23
Remote Control Key Functions	6	Auto Sleep	23
Location and Function of Controls	7~10	Sleep Timer	23
Installation		Special Menu Options	
External Equipment Viewing Setups	11~12	Child Lock	24
Displayable Monitor Specification	13	ISM (Image Sticking Minimization) Method	24
HDMI	14~15	Low Power	25
Accessories	16	XD Demo	25
Installation Options	17	Menu Rotation for Vertical Viewing (option)	25
Operation		Screen Menu Options	
Turning on the Set	18	Auto adjustment	26
On-Screen Menu Language Selection (option)	18	Manual Configure	26
Picture Menu Options		Selecting Wide VGA/XGA mode	26
PSM (Picture Status Memory)	19	Initializing (Reset to original factory value)	26
CSM (Color Status Memory)	19	Setting Picture Format	27
Manual Colour Temperature Control	19	Picture Size Zoom	27
XD	19	Screen Position	27
sRGB (RGB[PC], HDMI[PC] mode only)	20	Cinema	28
ACM (Active Color Management)	20	NR (Noise Reduction)	28
Manual Picture Control	20	Split Zoom	28
Sound Menu Options		Miscellaneous	
SSM (Sound Status Memory)	21	External Control Device Setup	29~34
BBE	21	IR Code (NEC Format)	35~37
AVL (Auto Volume Leveler)	21	Troubleshooting Checklist	38
Adjusting Sound Control	22	Product Specifications	39
Speaker	22		

After reading this manual, keep it in the place where the user can always contact easily.

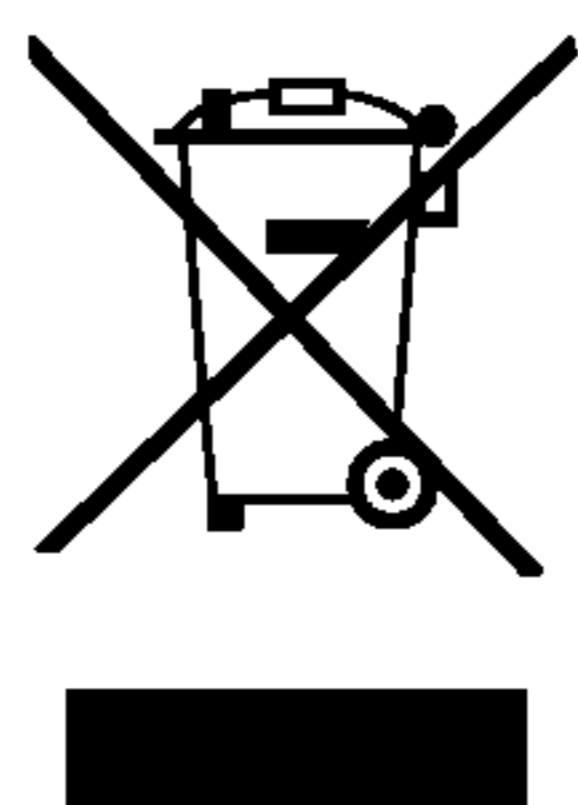

Disposal of your old appliance

1. When this crossed-out wheeled bin symbol is attached to a product it means the product is covered by the European Directive 2002/96/EC.
2. All electrical and electronic products should be disposed of separately from the municipal waste stream via designated collection facilities appointed by the government or the local authorities.
3. The correct disposal of your old appliance will help prevent potential negative consequences for the environment and human health.
4. For more detailed information about disposal of your old appliance, please contact your city office, waste disposal service or the shop where you purchased the product.

Introduction

What is a Plasma Display ?

If voltage is inputted to gas in glass panels, ultraviolet rays is outputted and fused with a fluorescent substance. At this moment, light is emitted. A Plasma Display is a next generation flat Display using this phenomenon.

160° - Wide angle range of vision

A Plasma Display provides more than 160° angle range of vision so that you can get a picture without distortion from any direction.

Easy installation

A Plasma Display is much lighter and smaller than other same class products so that you can install the Plasma Display at the desired place.

Big screen

The screen of a Plasma Display is 42" (50" or 60") so that you can get vivid experience as if you are in a theater.

Multimedia Plasma Display

A Plasma Display can be connected with a computer so that you can use it as a screen for conference, game, internet and so on.

The explanation about coloured dots may be present on PDP screen

The PDP which is the display device of this product is composed of 0.9 to 2.2 million cells and a few cell defects can occur in the manufacture of the PDP. Several coloured dots visible on the screen would be acceptable, in line with other PDP manufacturers and would not mean that the PDP is faulty. We hope you will understand that the product which corresponds to this standard is regarded as acceptable. It means that it could not be changed or refunded. We promise that we'll do our best to develop our technology to minimize the cell defects.

The explanation about noise of PDP (option)

In the same way that a fan is used in a PC to keep the CPU cool, the PDP is equipped with cooling fans to improve the reliability of this product. Therefore, a certain level of noise could occur when the fan is operated. This noise doesn't have any negative effect on its efficiency and liability and it's also determined to have no difficulty while using this product. The noise from the fans is normal in the operation of this product. We hope you will understand that a certain level of noise is acceptable. It means that it is not changeable nor refundable.

TO AVOID BURNING IMAGE INTO THE DISPLAY, DO NOT HAVE A STILL IMAGE ON SCREEN FOR EXTENDED PERIOD OF TIME. IMAGE AFTER BURN WILL NOT BE COVERED UNDER WARRANTY ie.Menus, Video games, Borders or LOGOS

WARNING

This is Class A product. In a domestic environment this product may cause radio interference in which case the user may be required to take adequate measures.

WARNING

TO REDUCE THE RISK OF FIRE AND ELECTRIC SHOCK, DO NOT EXPOSE THIS PRODUCT TO RAIN OR MOISTURE.

Remote Control Key Functions

- When using the remote control aim it at the remote control sensor of the set.
- There's maybe a defect in consecutive operation of remote control in specified brightness according to this set feature.

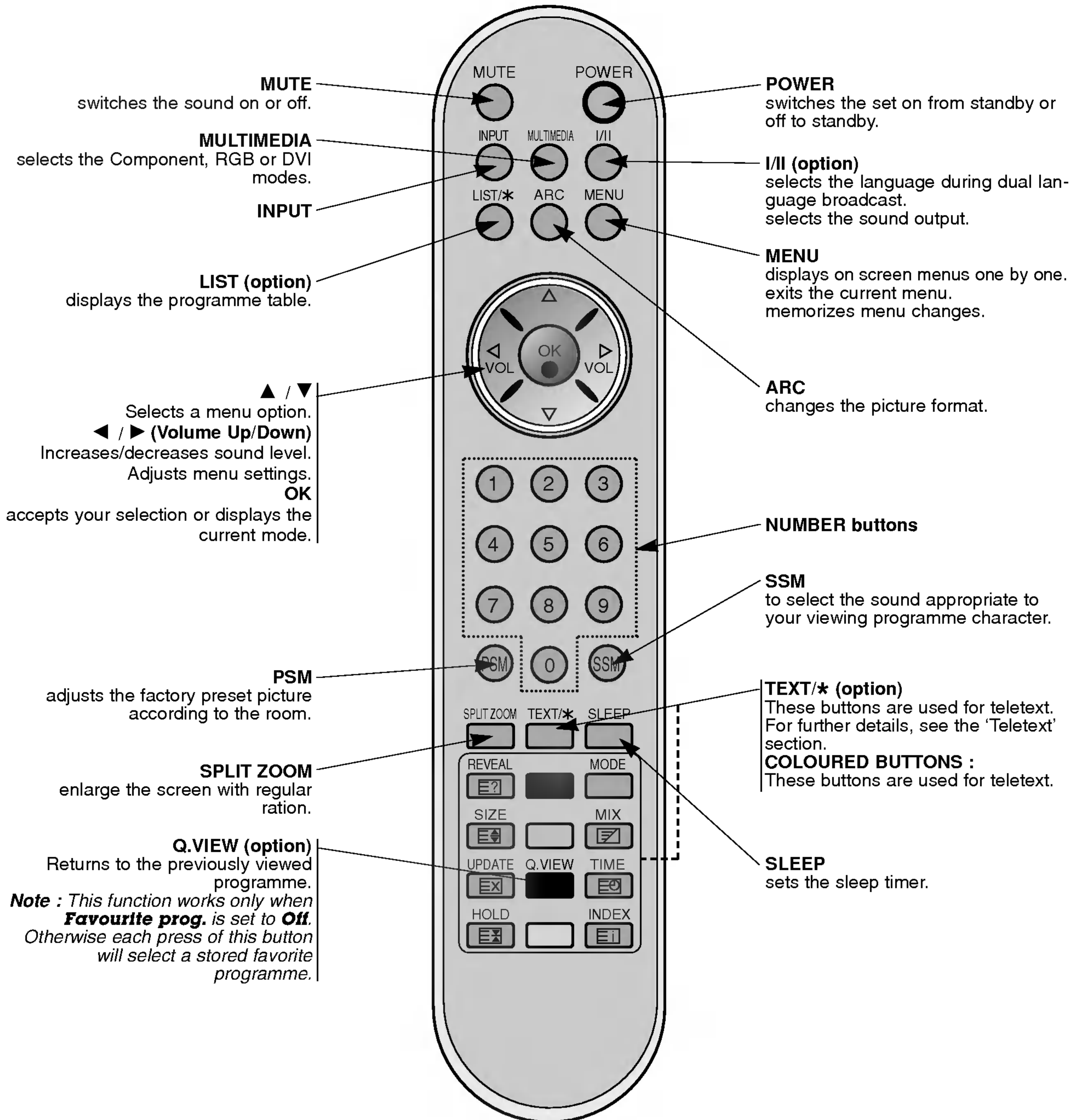

Installing Batteries

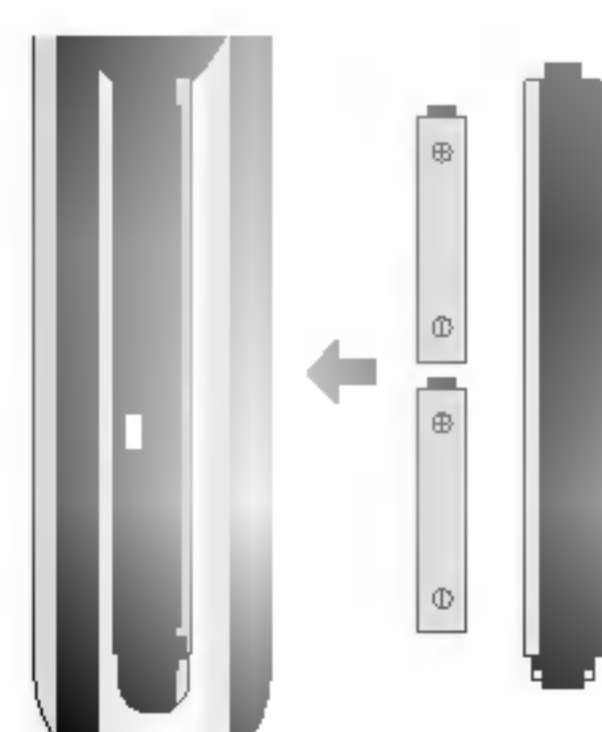

- Open the battery compartment cover on the back side and insert the batteries with correct polarity.
- Install two 1.5V alkaline batteries of AAA type. Don't mix used batteries with new batteries.

Location and Function of Controls

- Shown is a simplified representation of the set.
- Here shown may be somewhat different from your set.

<Front Panel Controls>

42PM1M/H series / 50PM1M/H series

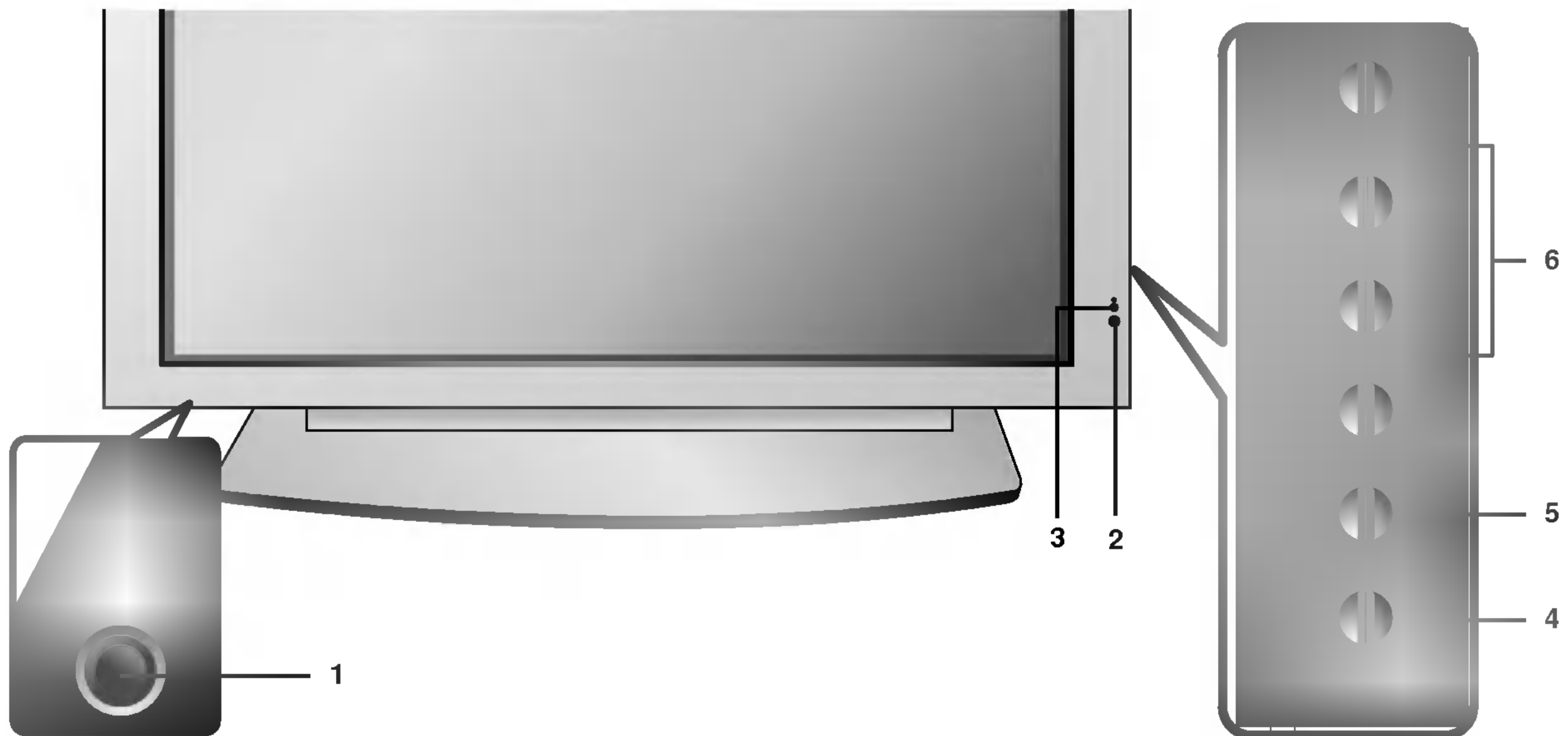

1. Main Power Button

2. Remote Control Sensor

3. Power Standby Indicator

Illuminates red in standby mode, Illuminates green when the set is turned on

4. INPUT SELECT Button

5. MENU

Displays on screen menus one by one.
Exits the current menu.
Memorizes menu changes.

6. ▲ / ▼

Selects a menu option.

◀ / ▶ (Volume Up/Down)

Increases/decreases sound level.
Adjusts menu settings.

60PZ9M/H series

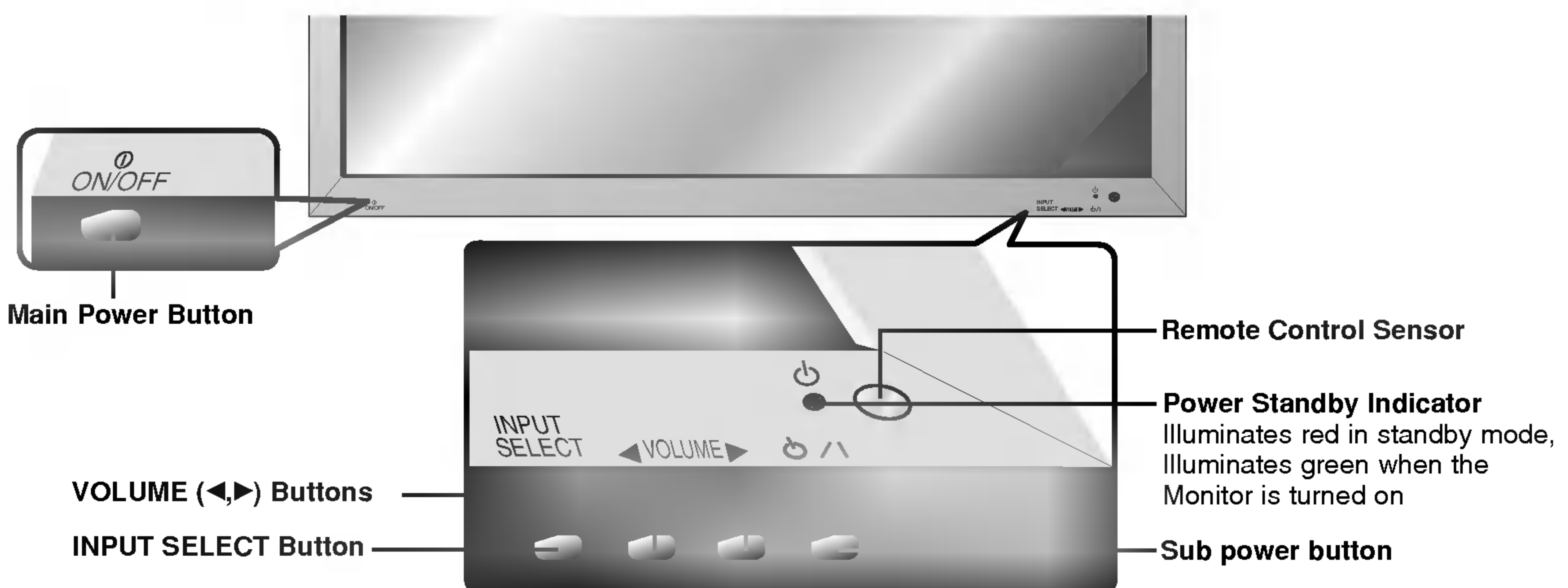

Main Power Button

VOLUME (◀,▶) Buttons

INPUT SELECT Button

Remote Control Sensor

Power Standby Indicator

Illuminates red in standby mode,
Illuminates green when the
Monitor is turned on

Sub power button

Location and Function of Controls

<Front Panel Controls>

42PM3MV/H series

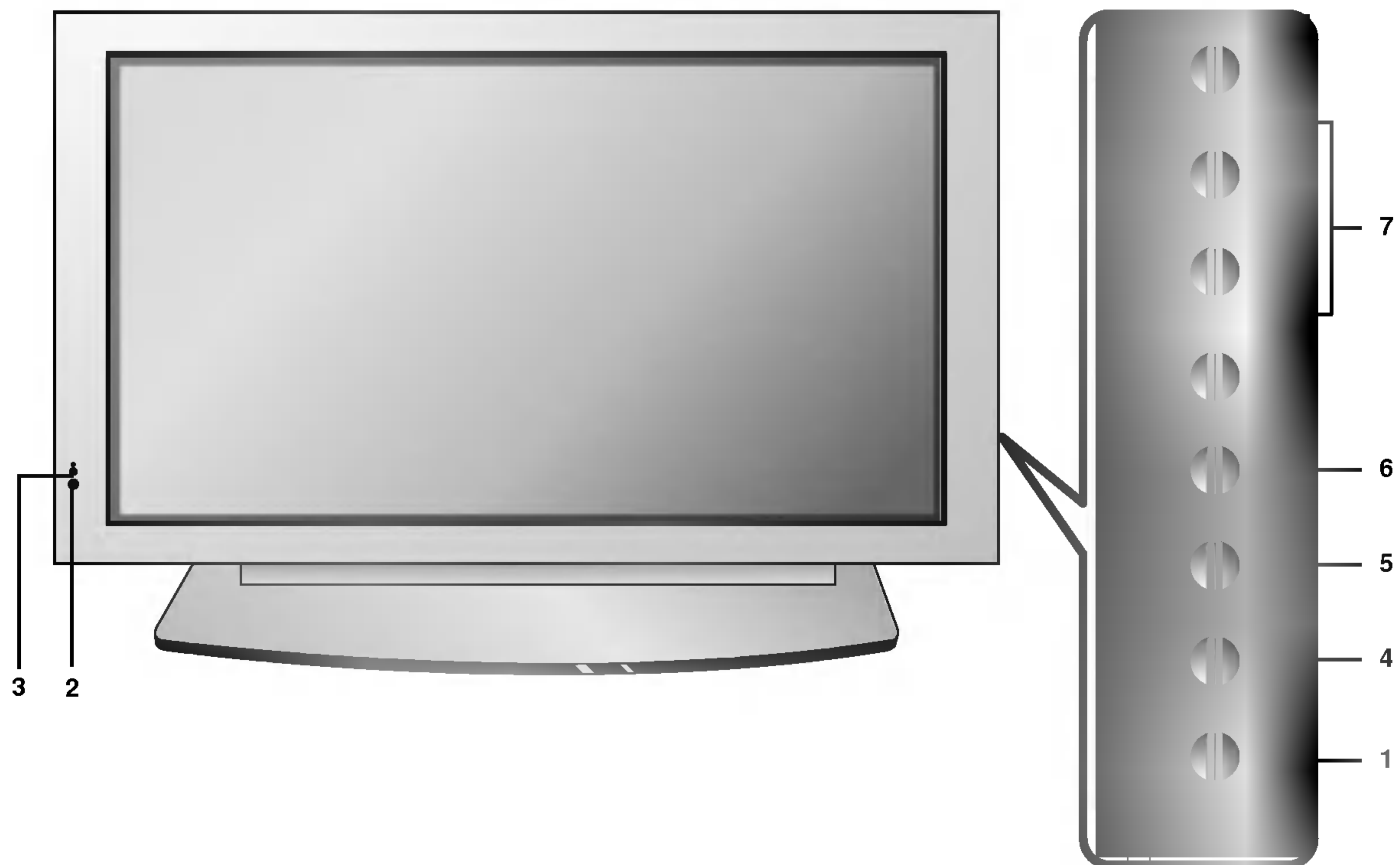

1. **Power Button**
Switches the set on from standby or off to standby.
2. **Remote Control Sensor**
3. **Power Standby Indicator**
Illuminates red in standby mode, Illuminates green when the set is turned on
4. **INPUT SELECT Button**
5. **MENU**
Displays on screen menus one by one.
Exits the current menu.
Memorizes menu changes.
6. **OK**
Accepts your selection or displays the current mode.
7. **▲ / ▼**
Selects a menu option.
◀ / ▶ (Volume Up/Down)
Increases/decreases sound level.
Adjusts menu settings.

<Back Panel>

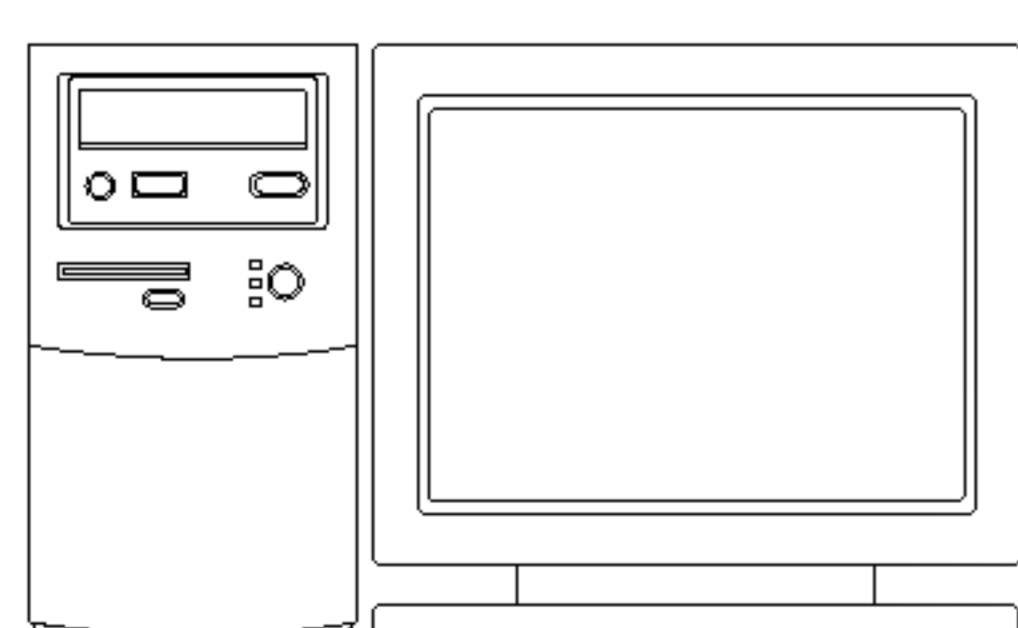
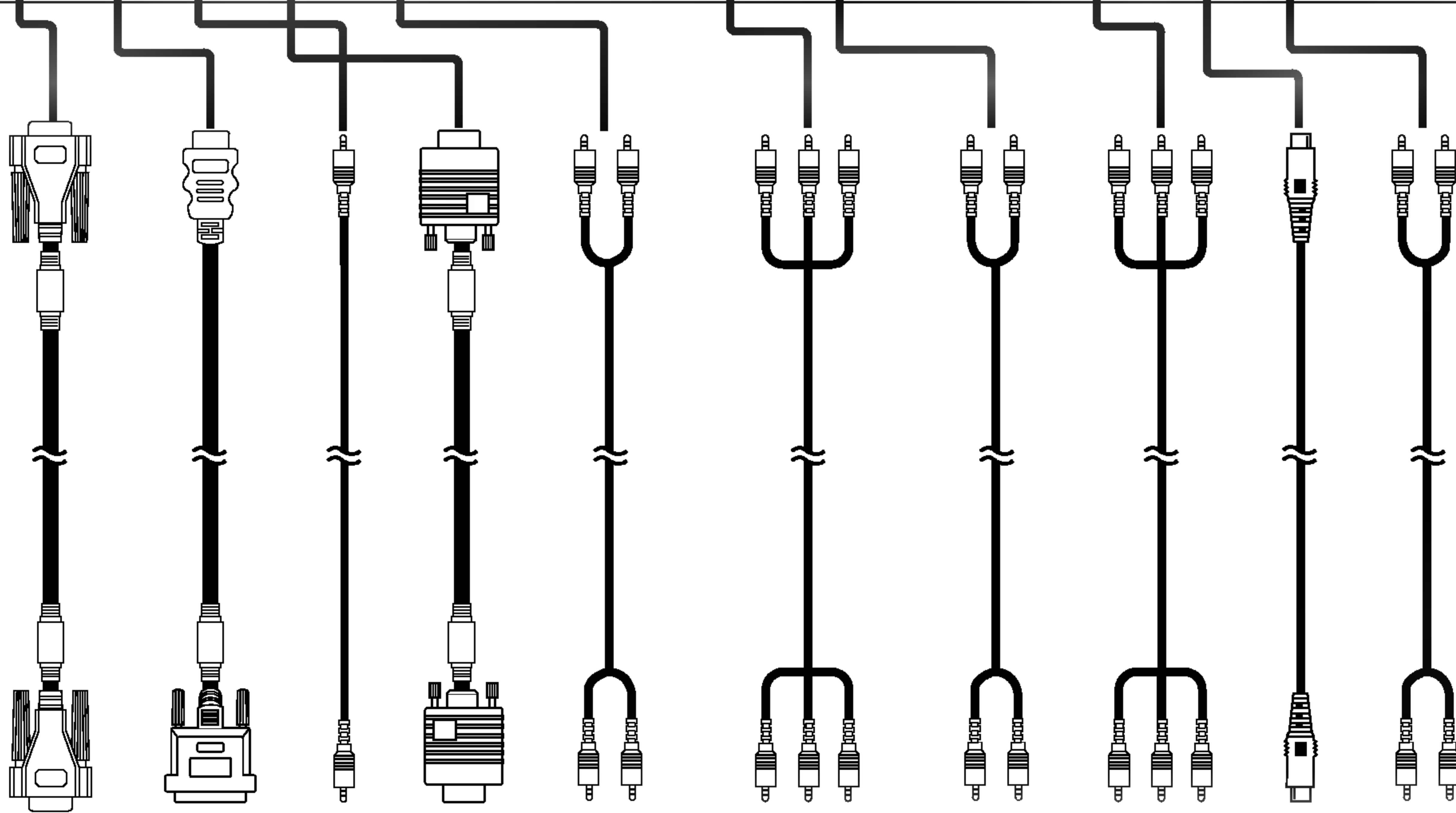
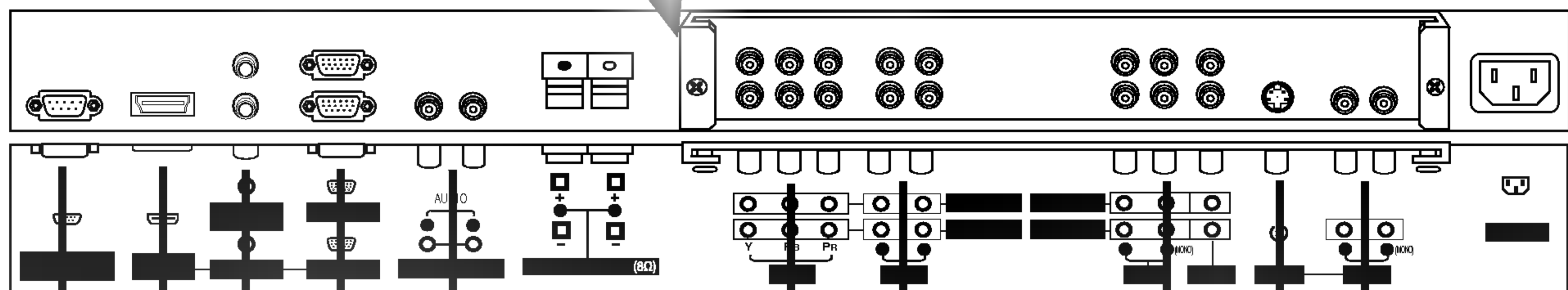
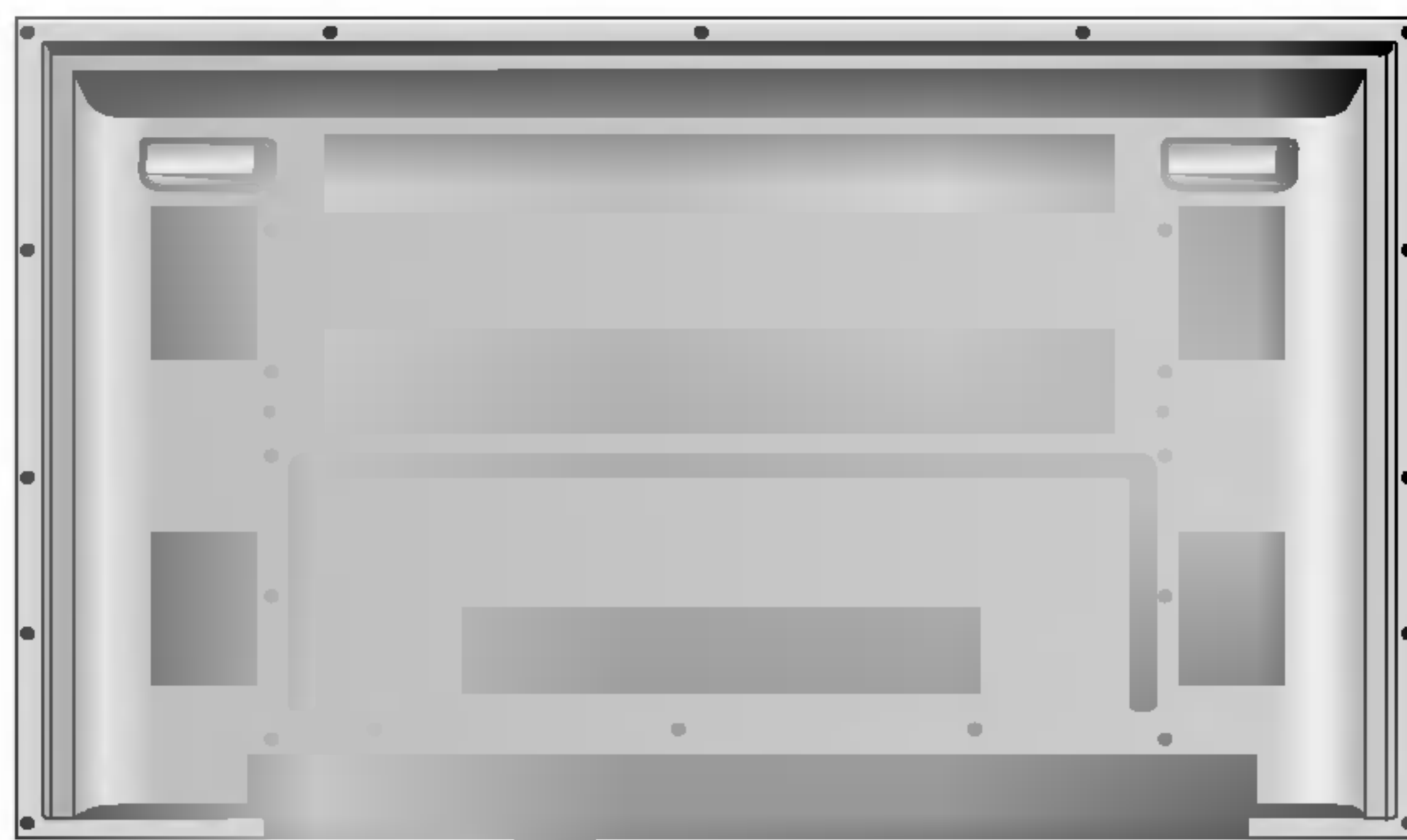

Connection to PC



Connection to AV equipment

Location and Function of Controls

<Back Panel>

RCA Type

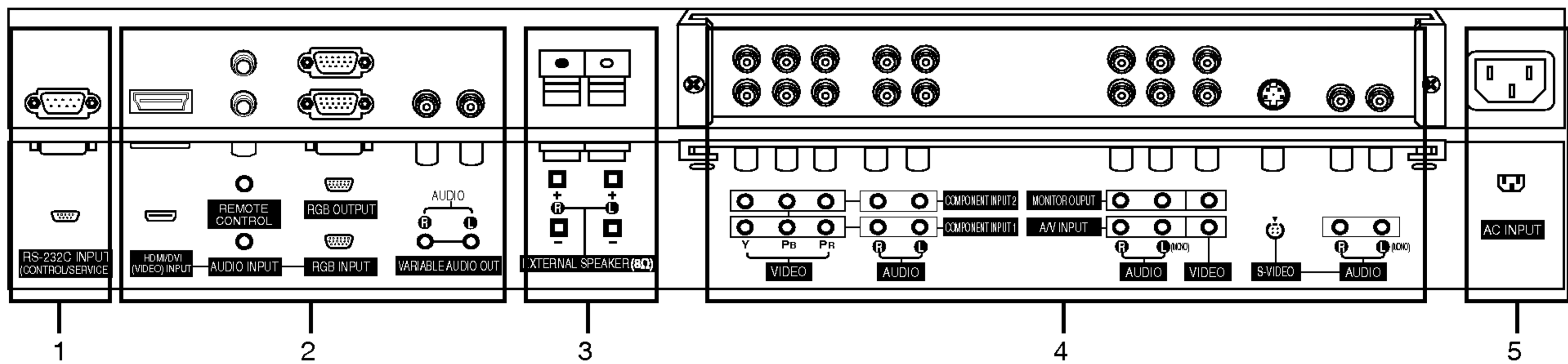

Scart Type

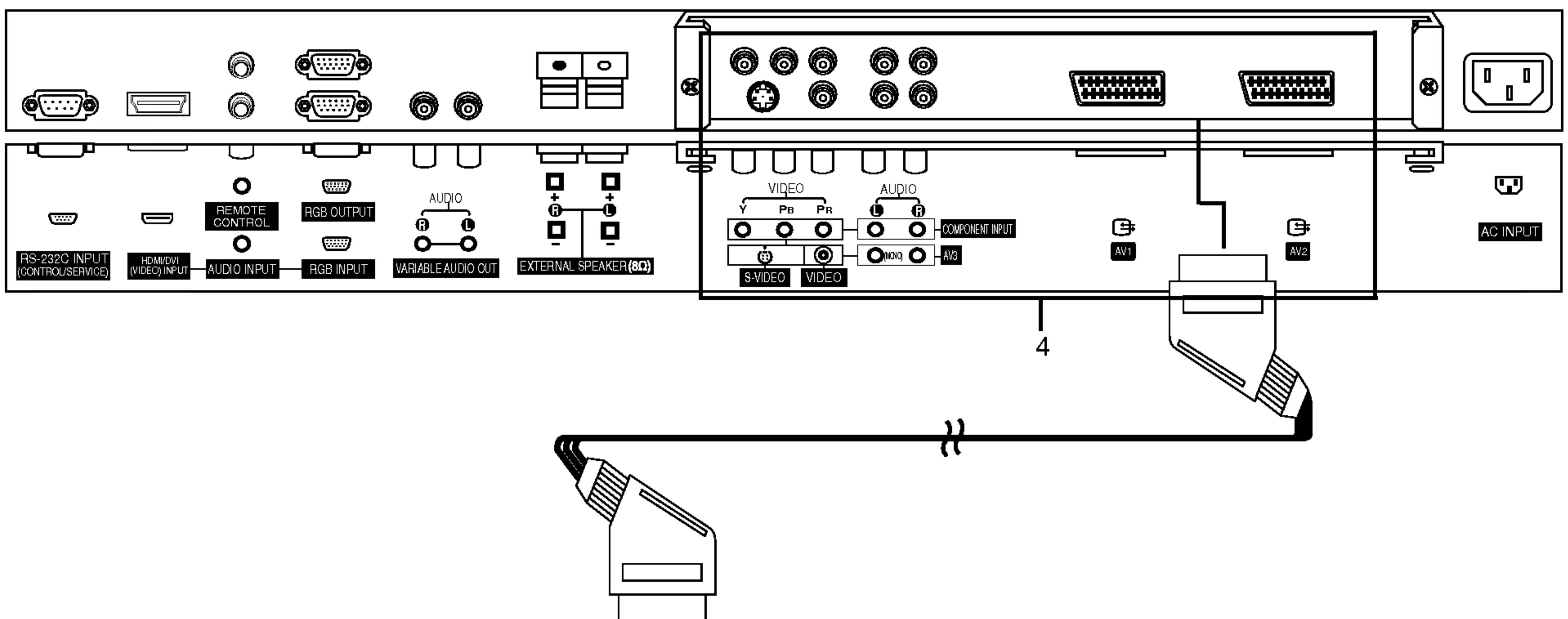

1. RS-232C INPUT (CONTROL/SERVICE) PORT

Connect to the RS-232C port on a PC.

2. HDMI/DVI (VIDEO) / AUDIO INPUT / RGB INPUT SOCKETS

Connect the set output socket of the PERSONAL COMPUTER to this socket.

Note: If you want to use RGB/DVI audio, we strongly recommend that you use the cable that has a core, or the EMI Filter core along with separate cable.

RGB OUTPUT SOCKET

You can watch the RGB signal on another set, connect RGB OUTPUT to another set's PC input port.

REMOTE CONTROL

VARIABLE AUDIO OUTPUT

3. EXTERNAL SPEAKER OUTPUT (8 ohm)

Connect to optional external speaker(s).

* For further information, refer to 'Speaker & Speaker Stand' manual.

4. COMPONENT / AUDIO INPUT SOCKETS S-VIDEO / AUDIO (L/MONO) INPUT SOCKETS VIDEO / AUDIO (L/MONO) INPUT SOCKETS

EURO SCART SOCKET

Connect the euro scart socket of the VCR to these sockets.

Note:

a. If you want to use the EURO scart cable, you have to use the signal shielded Euro scart cable.

b. If you want to use your external hi-fi stereo system, turn off the internal speakers of the set.

c. If the S-VIDEO(Y/C) signal is received through the Euro scart socket 2 (AV 2), you must change to the S-Video 2 (Y/C) mode.

5. POWER CORD SOCKET

This set operates on an AC power. The voltage is indicated on the Specifications page. Never attempt to operate the set on DC power.

External Equipment Viewing Setups

Watching VCR (When the Interface board is installed.)

- When connecting the set with external equipments, match the colours of connecting ports (Video - yellow, Audio(L) - white, Audio(R) -red).
- Connect the VIDEO INPUT socket(yellow) to the VIDEO INPUT socket of the set.
- If you have a mono VCR, connect the audio cable from the VCR to the AUDIO(L/MONO) input of the set.
- If you connect an S-VIDEO VCR to the S-VIDEO input, the picture quality is improved; compared to connecting a regular VCR to the Video input.
- Or, connect the Euro scart socket of the VCR to the Euro scart socket of the set.

Avoid having a fixed image remain on the screen for a long period of time. Typically a frozen still picture from a VCR, 4:3 picture format or if a CH label is present; the fixed image may remain visible on the screen.
Use the orbiter function to avoid having a fixed image. (Refer to p.24)

1. Press **INPUT** button on the remote control and select **AV, S-Video** or (**AV1, AV2, S-Video2** or **AV3**).
(If both **S-VIDEO** and **VIDEO** sockets have been connected to the S-VHS VCR simultaneously, only the **S-VIDEO** can be received.)
2. Insert a video tape into the VCR and press the **PLAY** button on the VCR. (See VCR owner's manual)

Watching Cable TV (When the Interface board is installed.)

- After subscribing to a cable TV service from a local provider and installing a converter, you can watch cable TV programming. This set cannot display TV programming without a TV tuner device or cable TV converter box connected to the set.

1. Press **INPUT** button on the remote control and select **AV, S-Video** or (**AV1, AV2, S-Video2** or **AV3**).
2. Tune to cable service provided channels using the cable box.

Watching external AV source (When the Interface board is installed.)

- When connecting the set with external equipments, match the colours of connecting ports.
- Or, connect the Euro scart socket of the VCR to the Euro scart socket of the set.

1. Press **INPUT** button on the remote control of the set to select **AV, S-Video** or (**AV1, AV2, S-Video2** or **AV3**).
2. Operate the corresponding external equipment. (See external equipment operating guide.)

Watching DVD (When the Interface board is installed.)

How to connect

- Connect DVD video inputs to Y, P_B, P_R of COMPONENT (DVD INPUT) and audio inputs to Audio sockets of AUDIO INPUT.
- Or, connect the Euro scart socket of the VCR to the Euro scart socket of the set.

How to use

1. Press **INPUT** or **MULTIMEDIA** button on the remote control of the set to select **Component** or (**Component1** or **Component2**).
2. Try this after turning on the DVD player.
(Refer to the DVD player's manual for operating instructions.)

• Component Input ports

You can get better picture quality if you connect DVD player with component input ports as below.

Component ports of the set	Y		
Video output ports of DVD player	Y	Pb	
	Y	B-Y	
	Y	Cb	
	Y	PB	

External Equipment Viewing Setups

Watching DTV Setup (option) (When the Interface board is installed.)

- To watch digitally broadcast programs, purchase/connect a digital set-top box.

How to connect a user-supplied Digital Set-Top Box

- Connect DTV set-top box video output to set COMPONENT (DVD/DTV INPUT) or to the set RGB (PC/DTV INPUT) or to the set HDMI/DVI (PC/DTV INPUT) connector depending on your set-top box connectors.
- Connect DTV set-top box audio outputs to set AUDIO INPUT jacks.

How to use

1. Turn on the a digital set-top box. (Refer to the owner's manual for the digital set-top box)
2. Use **INPUT** or **MULTIMEDIA** on the remote control to select **Component** or (**Component1** or **Component2**), **RGB** or **HDMI**.

• DTV Input signal

Mode \ Terminal	Component	RGB (DTV)	HDMI (DTV)
480i	o	x	x
576i	o	x	x
480p	o	o	o
576p	o	o	o
720p	o	o	o
1080i	o	o	o

Connecting PC

- To enjoy vivid picture and sound, connect a PC to the set.
- Avoid keeping a fixed image on the set's screen for a long period of time. The fixed image may become permanently imprinted on the screen; use a screen saver when possible.
- Connect PC to the RGB INPUT(PC INPUT) or HDMI/DVI INPUT(DIGITAL RGB INPUT) port of the set; change the resolution output of PC accordingly.
- There might be a noise according to some resolution, vertical pattern, contrast or brightness in PC mode. Then change the PC mode into other resolution or change the refresh rate into other rate or adjust the brightness and contrast on the menu until the picture is clean. If the refresh rate of the PC graphic card can not be changed, change the PC graphic card or consult it to the manufacturer of the PC graphic card.
- The synchronization input form for Horizontal and Vertical frequencies is separate.

Setup Instructions to Connect a PC to your set

- We recommend using 1024x768, 60Hz for the PC mode, they provide the best picture quality.
- If the resolution of PC is over UXGA, there will be no picture on the set.
- Connect the signal cable from the monitor output port of the PC to the RGB INPUT port of the set or the signal cable from the DVI output port of the PC to the HDMI/DVI INPUT port on the set.
- Connect the audio cable from the PC to the Audio input on the set. (Audio cables are not included with the set).
- If using a sound card, adjust PC sound as required.
- This set apply a VESA Plug and Play Solution. The set provides EDID data to the PC system with a DDC protocol. The PC adjusts automatically to use this set.
- DDC protocol is preset for RGB (Analog RGB), DVI (Digital RGB) mode.
- If required, adjust the set settings for Plug and Play functionally.
- If graphic card on the PC does not output analog and digital RGB simultaneously, connect only one of both RGB INPUT or HDMI/DVI INPUT to display the PC on the set.
If graphic card on the PC output analog and digital RGB simultaneously, set the set to either RGB or HDMI; (the other mode is set to Plug and Play automatically by the set.)
- DOS mode may not work depending on video card if using a DVI-I cable.

PC Setup

1. Turn on the PC and apply power to the set.
2. Turn on the display by pressing the **POWER** button on the set's remote control.
3. Use the **INPUT** or **MULTIMEDIA** button on the remote control to select the **RGB** or **HDMI** input source.
4. Set the resolution output of the PC to SXGA or under (1280 x 1024, 60Hz). (Refer to p. 13)

Displayable Monitor Specification

RGB / HDMI mode

Resolution	Horizontal Frequency(KHz)	Vertical Frequency(Hz)
640x350	31.468	70.09
	37.861	85.08
720x400	31.469	70.08
	37.927	85.03
640x480	31.469	59.94
	35.000	66.66
	37.861	72.80
	37.500	75.00
848x480	43.269	85.00
	31.500	60.00
	37.799	70.00
	39.375	75.00
852x480	31.500	60.00
	37.799	70.00
	39.375	75.00
800x600	31.500	60.00
	37.799	70.00
	39.375	75.00
	35.156	56.25
	37.879	60.31
832x624	48.077	72.18
	46.875	75.00
	53.674	85.06
	49.725	74.55
1024x768	48.363	60.00
	56.476	70.06
	60.023	75.02
	68.677	85.00
1152x864	54.348	60.05
	63.995	70.01
	67.500	75.00
1152x870	68.681	75.06
1280x960	60.023	60.02
1280x1024	63.981	60.02

42PM3MV/H series

RGB / HDMI mode

Resolution	Horizontal Frequency(KHz)	Vertical Frequency(Hz)
640x350	31.468	70.09
	37.861	85.08
720x400	31.469	70.08
	37.927	85.03
640x480	31.469	59.94
	35.000	66.66
	37.861	72.80
	37.500	75.00
848x480	43.269	85.00
	31.500	60.00
	37.799	70.00
	39.375	75.00
852x480	31.500	60.00
	37.799	70.00
	39.375	75.00
800x600	31.500	60.00
	37.799	70.00
	39.375	75.00
	35.156	56.25
	37.879	60.31
832x624	48.077	72.18
	46.875	75.00
	53.674	85.06
	49.725	74.55
1024x768	48.363	60.00
	56.476	70.06
	60.023	75.02
	68.677	85.00
1360x768	47.700	60.00
	59.625	75.02
1366x768	47.700	60.00
	59.625	75.02
1152x864	54.348	60.05
	63.995	70.01
	67.500	75.00
1152x870	68.681	75.06
1280x768	47.693	59.99
	60.091	74.93
1280x960	60.023	60.02
1280x1024	63.981	60.02

**42PM1M/H series
50PM1M/H series
60PZ9M/H series**



- HDMI™, the HDMI logo and High-Definition Multimedia Interface are trademarks or registered trademarks of HDMI Licensing LLC.
- This set can receive the High-Definition Multimedia Interface (HDMI) or Input of Digital Visual Interface(DVI).
- This set supports HDCP (High-bandwidth Digital Contents Protection) Protocol for the set (480p, 720p, 1080i) modes.
- When you Connect with HDMI/DVI Source Devices (DVD Player or Set Top Box or PC) supporting Auto HDMI/DVI function, automatically, support Plug & Play and then set the HDMI/DVI Source Devices (1280 x 720p) (or 42PM3MV/H series: 640 x 480p). After reading in HDMI/DVI Source Devices using Display Data Channel(DDC) Protocol, EDID stored in the set is used. If HDMI/DVI Source Devices not supported Auto HDMI/DVI is been, the Resolution is set, manually.
- To get the best picture quality, adjust the DVD Player or Set Top Box output resolution to 1280 x 720p (or 42PM3MV/H series: 640 x 480p).
- To get the best picture quality, adjust the PC graphics card to 1024 x 768 (or 42PM3MV/H series: 640 x 480), 60Hz.
- When Source Devices have DVI Output Connector, you must connect audio with separated cable.
(Refer to <How to connect>)

How to connect

1. When Source Devices (DVD Player or Set Top Box) support HDMI.
 - If Source Devices have HDMI Output Connector, Source Devices connect to the set with HDMI Cable .(not supplied with the product).
 - If Source Devices support Auto HDMI, automatically, Source Devices divert output resolution in 1280 x 720p (or 42PM3MV/H series: 640 x 480p). But if not, resolution divert Manually Setting for reference Manual of Source Devices.
 - To get the best picture quality, adjust the DVD Player or Set Top Box output resolution to 1280 x 720p (or 42PM3MV/H series: 640 x 480p).
 - Because HDMI sends Digital Video and Audio with one cable, need not especial Audio Cable for using HDMI Cable.
2. When Source Devices (DVD Player or Set Top Box) supports DVI.
 - If Source Devices have DVI Output Connector, Source Devices connect to the set with HDMI to DVI Cable (not supplied with the product).
 - If Source Devices support Auto DVI, automatically, Source Devices divert output resolution in 1280 x 720p (or 42PM3MV/H series: 640 x 480p). But if not, resolution divert Manually Setting for reference Manual of Source Devices.
 - To get the best picture quality, adjust the DVD Player or Set Top Box output resolution to 1280 x 720p (or 42PM3MV/H series: 640 x 480p).
 - In this case, Audio use other cable. When Source Devices have Analog Audio Output Connector, RGB/DVI Audio Input of the set connect to Audio Cable (not supplied with the product). And then you can listen to normal Audio.
3. When PC supports DVI.
 - If PC have DVI Output Connector, Source Devices connect to the set with HDMI to DVI Cable (not supplied with the product).
 - To get the best picture quality, adjust the PC graphics card to 1024 x 768 (or 42PM3MV/H series: 640 x 480), 60Hz.
 - Use the the set's HDMI/DVI (VIDEO) for video connections, depending on your PC connector.
 - If the graphics card on the PC does not output analog RGB and DVI simultaneously, connect only one of either RGB Input or HDMI/DVI Input to display the PC on the set.
 - If the graphics card on the PC does output analog RGB and DVI simultaneously, the set to either RGB Input or HDMI/DVI Input; (the other mode is set to Plug and Play automatically by the set.)
 - Then, make the corresponding audio connections. If using a sound card, adjust the PC sound as required.
 - In this case, Audio use other cable. When PC (or sound card of PC) have Analog Audio Output Connector, RGB/DVI Audio Input of the set connect to Analog Audio Cable (not supplied with the product). And then you can listen to normal Audio.

Reference

Cable sample

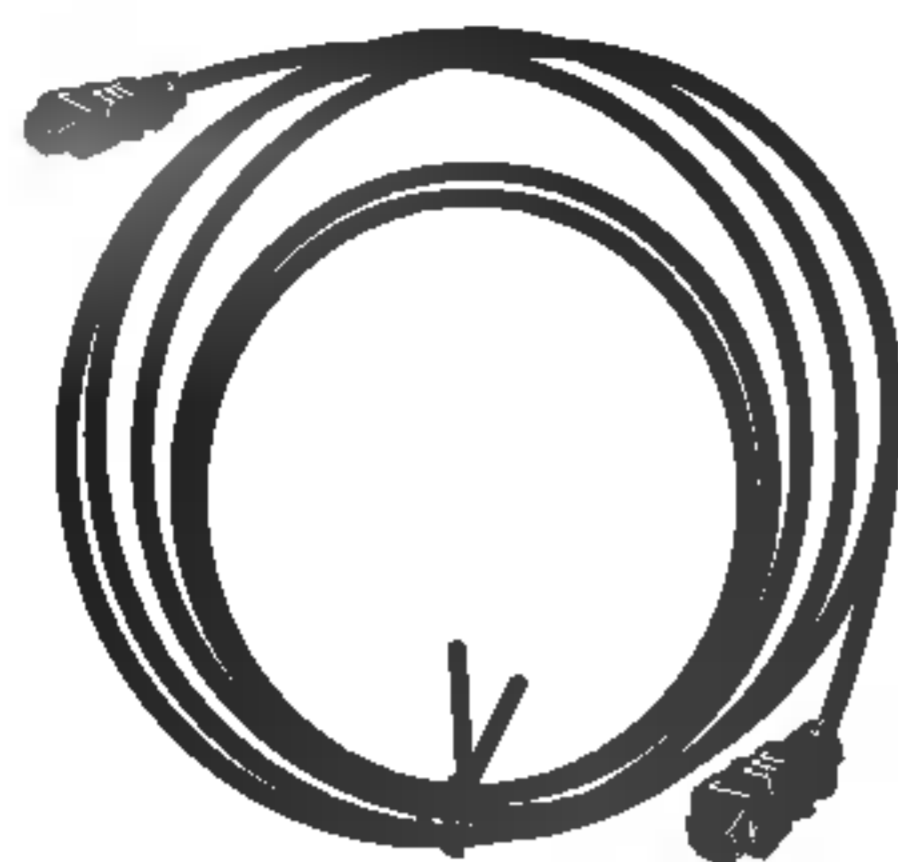

HDMI Cable
(not supplied with the product)

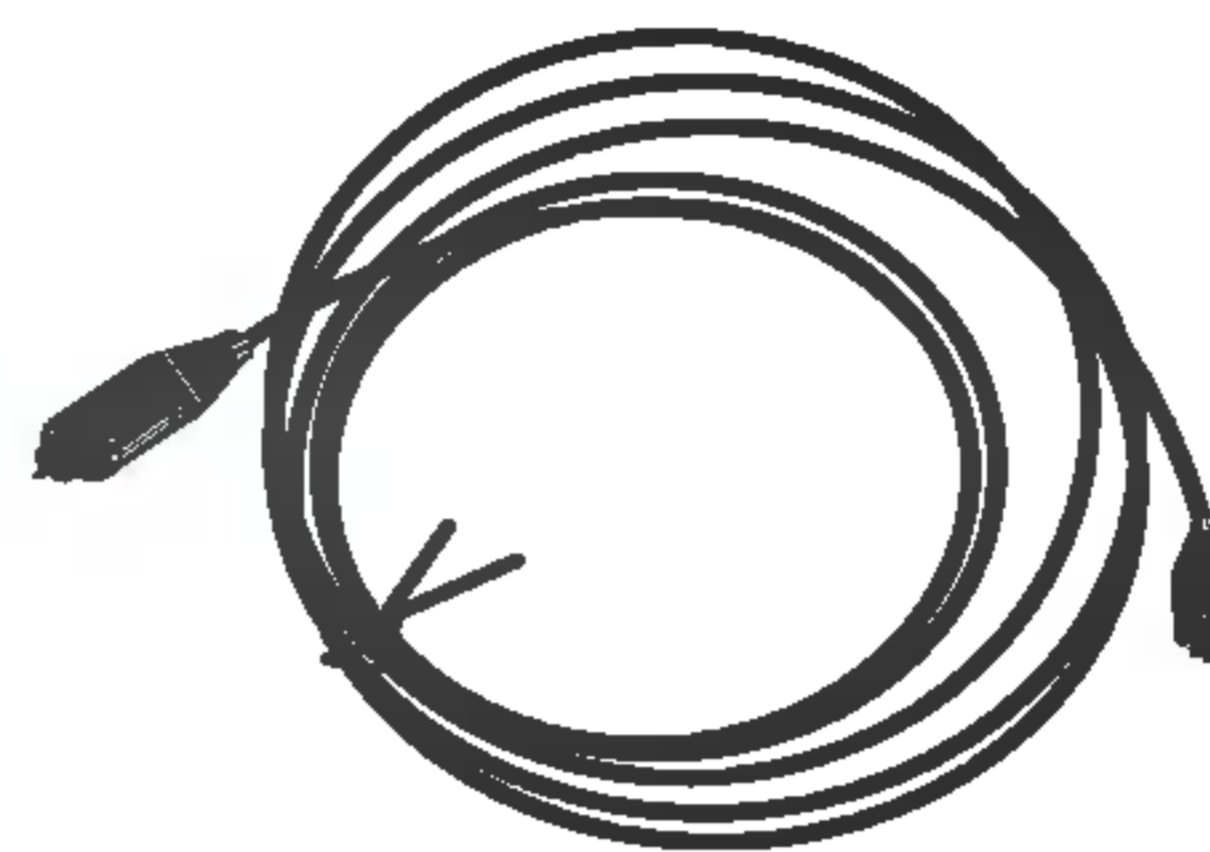

Analog Audio Cable (RCA type)
(not supplied with the product)



HDMI to DVI Cable
(not supplied with the product)

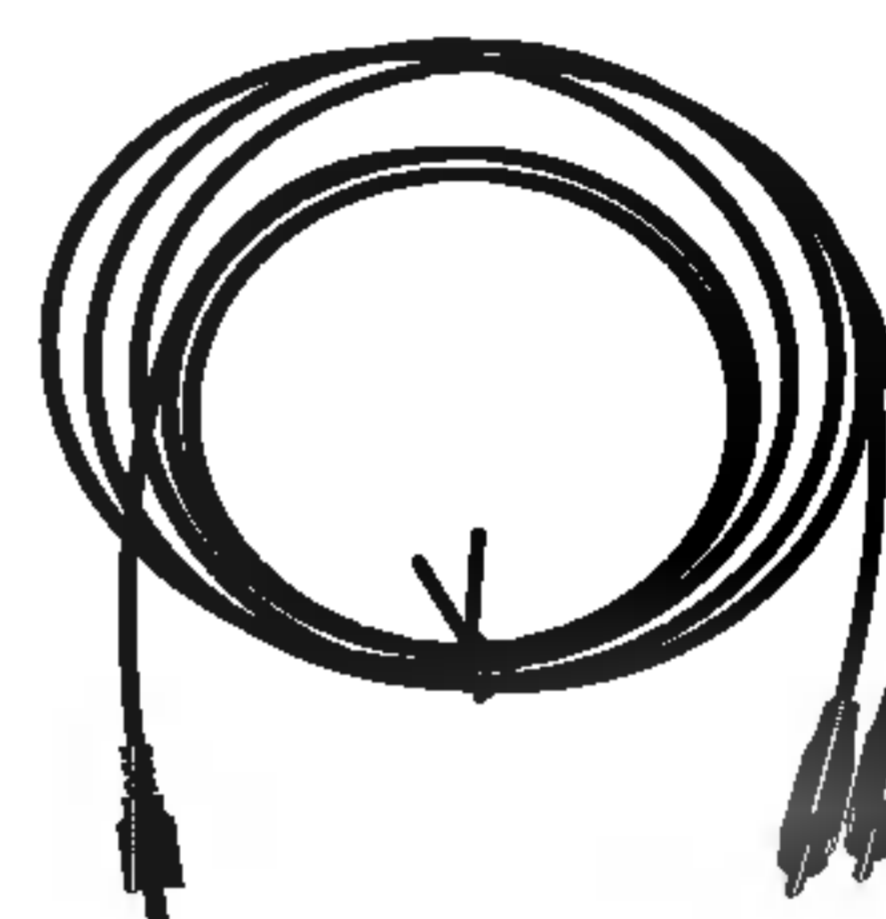

Analog Audio Cable (Stereo to RCA type)
(not supplied with the product)

How to use

1. Connect the HDMI/DVI Source Devices(DVD Player or Set Top Box or PC) and the set.
2. Turn on the display by pressing the POWER button on the set and HDMI/DVI Source Devices remote control.
3. Select HDMI/DVI Input source in Main Input option of SPECIAL menu.
4. Check the image on your set. There may be noise associated with the resolution, vertical pattern, contrast or brightness in HDMI/DVI Source Devices. If noise is present, change the HDMI/DVI Source Devices to another resolution, change the refresh rate or adjust the brightness and contrast on the menu until the picture is clear. If the refresh rate of the PC graphics card can not be changed, change the PC graphics card or consult the manufacturer of the PC graphics card.

Notes:

- Depending on the graphics card, DOS mode may not work if you use a HDMI to DVI Cable.
- Avoid keeping a fixed image on the set screen for a long period of time. The fixed image may become permanently imprinted on the screen. Use the Orbiter screen saver when possible.
- When Source Devices connected HDMI/DVI Input, output PC Resolution(VGA, SVGA, XGA), Position, Size may not fit to Screen. As shown in the lower picture, press the **MENU** button to adjust the screen Position of the set and contact a PC graphics card service center.
- When Source Devices connected HDMI/DVI Input output the set Resolution(480p, 720p, 1080i), the set Display fit EIA/CEA-861-B Specification to Screen. If not, refer to the Manual of HDMI/DVI Source Devices or contact your service center.
- In case HDMI/DVI Source Devices is not connected Cable or poor cable connection, "No Signal" OSD display in HDMI/DVI Input. And In case of Video Resolution not supported the set output in HDMI/DVI Source Devices, "No Signal" OSD display. Refer to the Manual of HDMI/DVI Source Devices or contact your service center.

Accessories

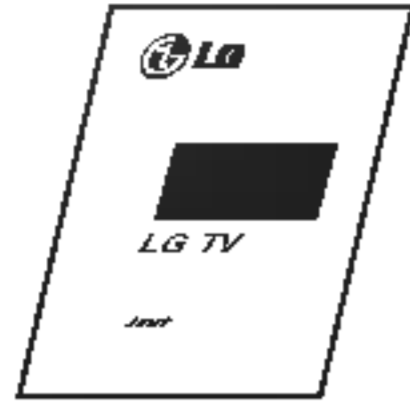

Owner's Manual

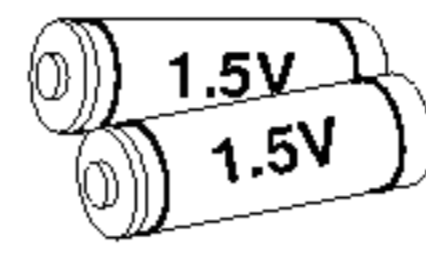

Alkaline batteries

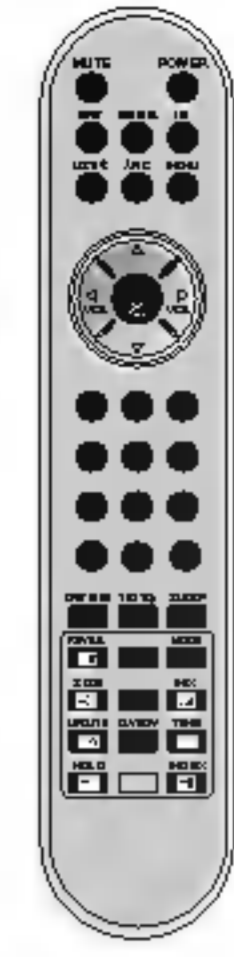

Remote Control handset

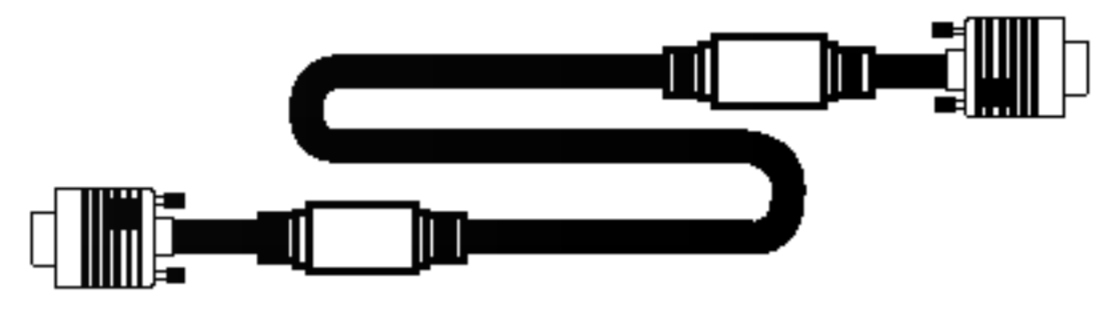

D-sub 15 pin cable
(60PZ9M/H series only)



Power Cord

Optional Extras

- Optional extras can be changed or modified for quality improvement without any notification new optional extras can be added.
- Contract your dealer for buying these items.

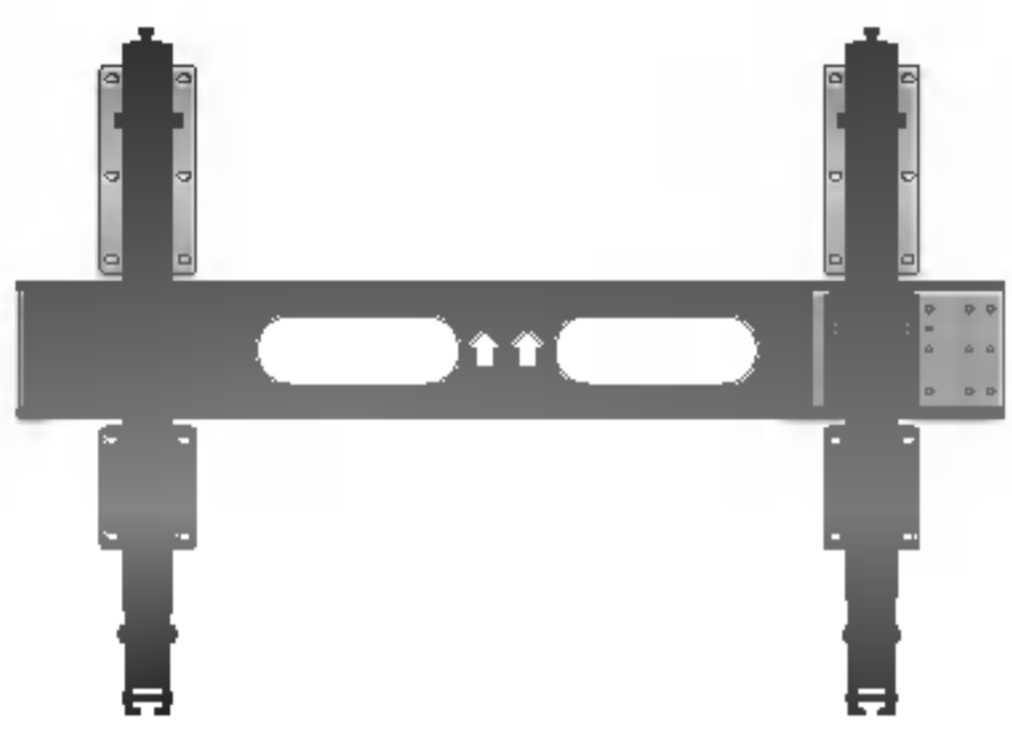

42/50PM1M/H series
42PM3MV/H series

Tilt wall mounting bracket

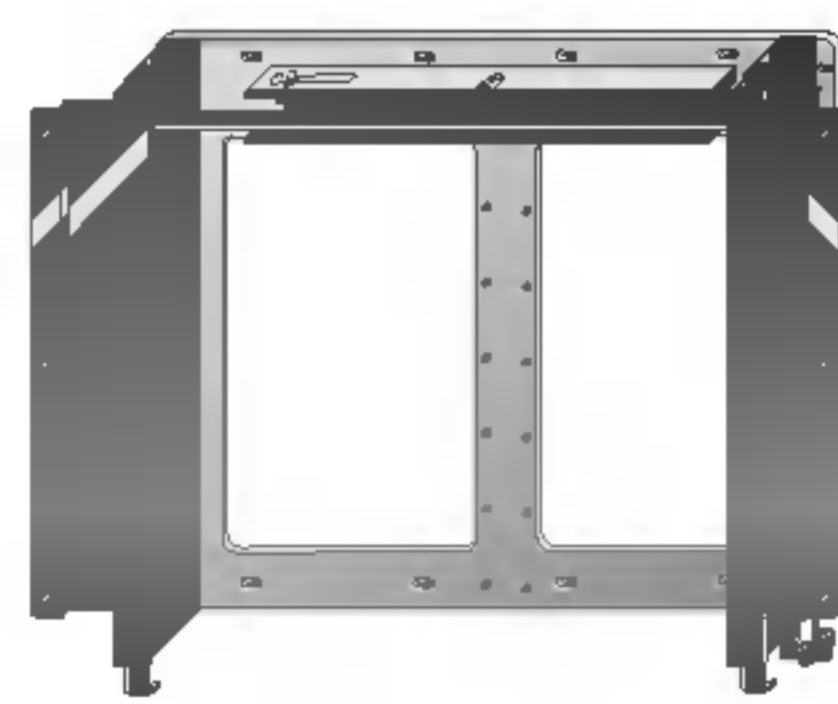

60PZ9M/H series

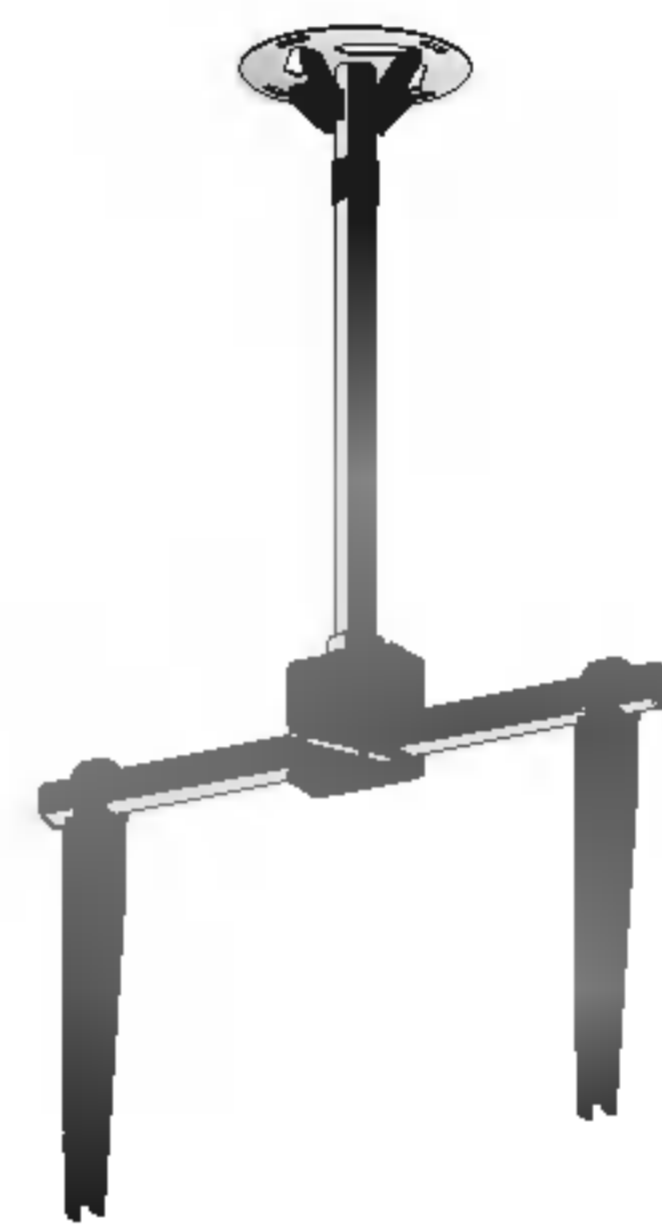

42/50PM1M/H series
42PM3MV/H series

Ceiling mounting bracket

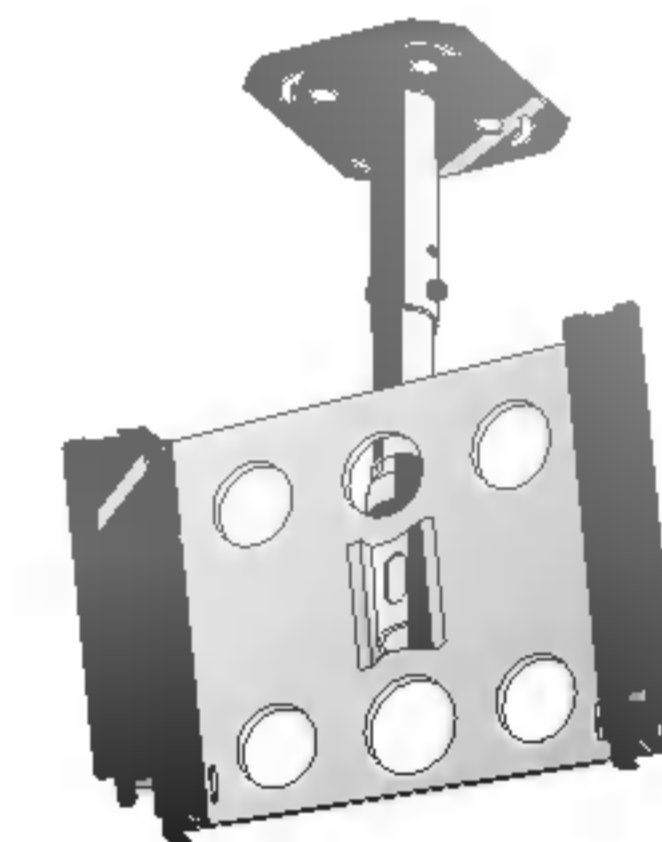

60PZ9M/H series

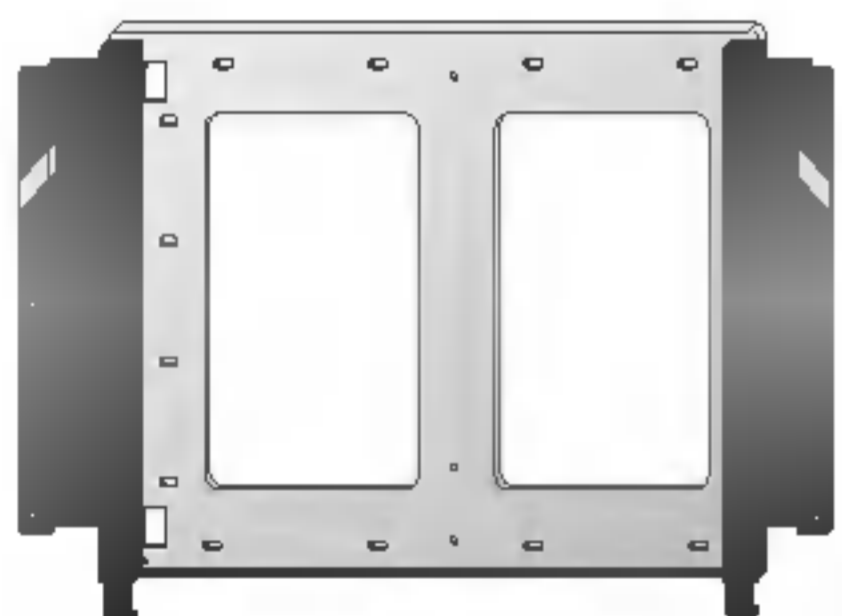

Wall mounting bracket

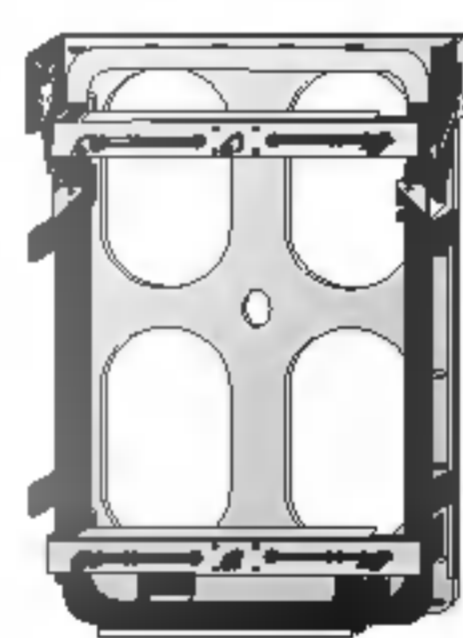

Vertical Wall mounting bracket

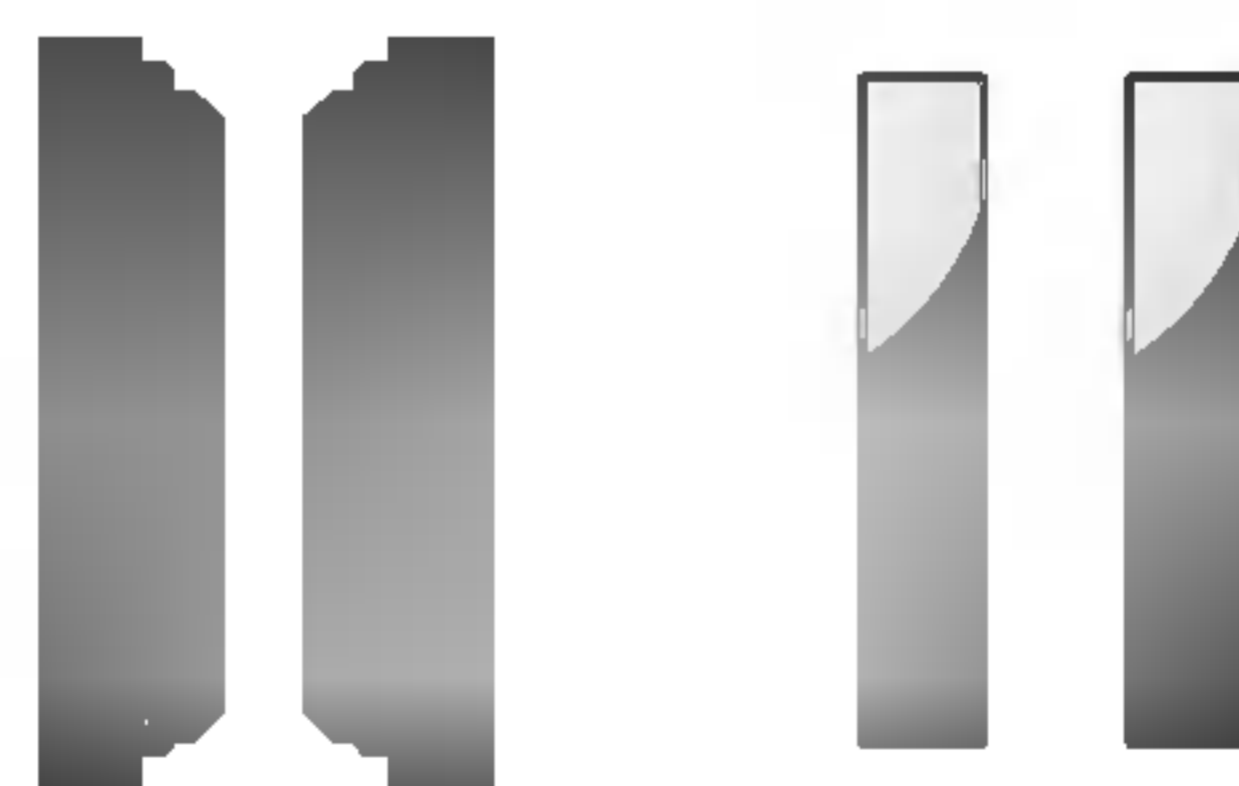

42/50PM1M/H series
42PM3MV/H series 60PZ9M/H series

Speakers



60PZ9M/H series
Desktop Speaker stand

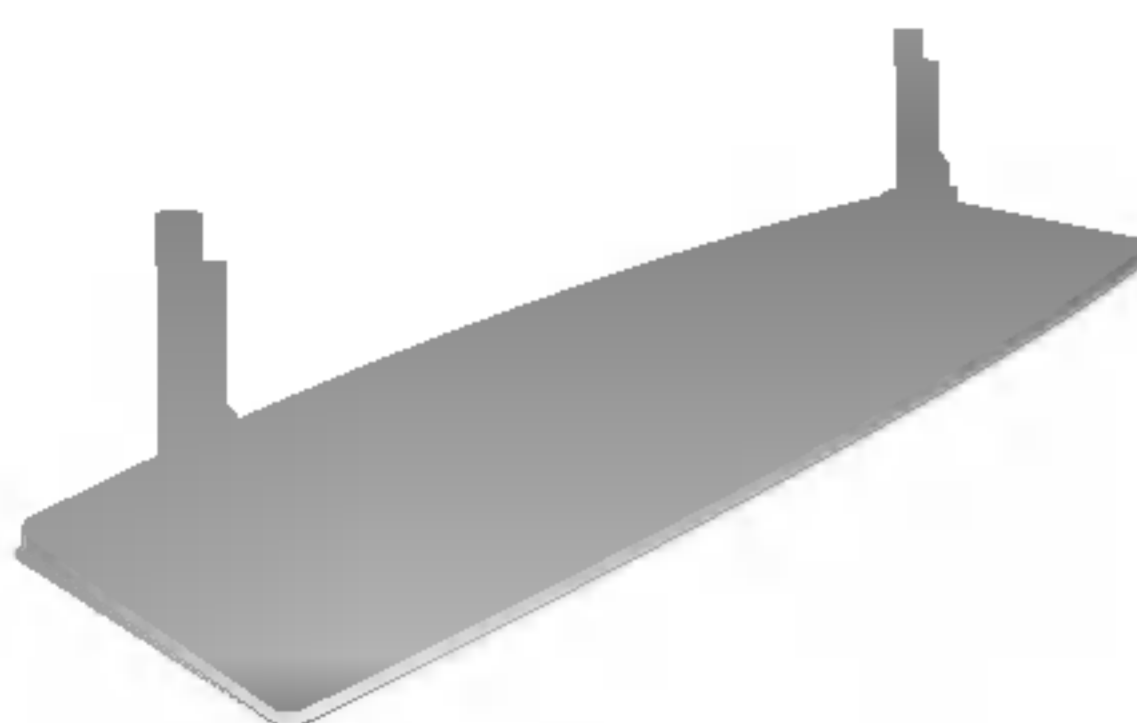

42/50PM1M/H series
42PM3MV/H series

Desktop stand

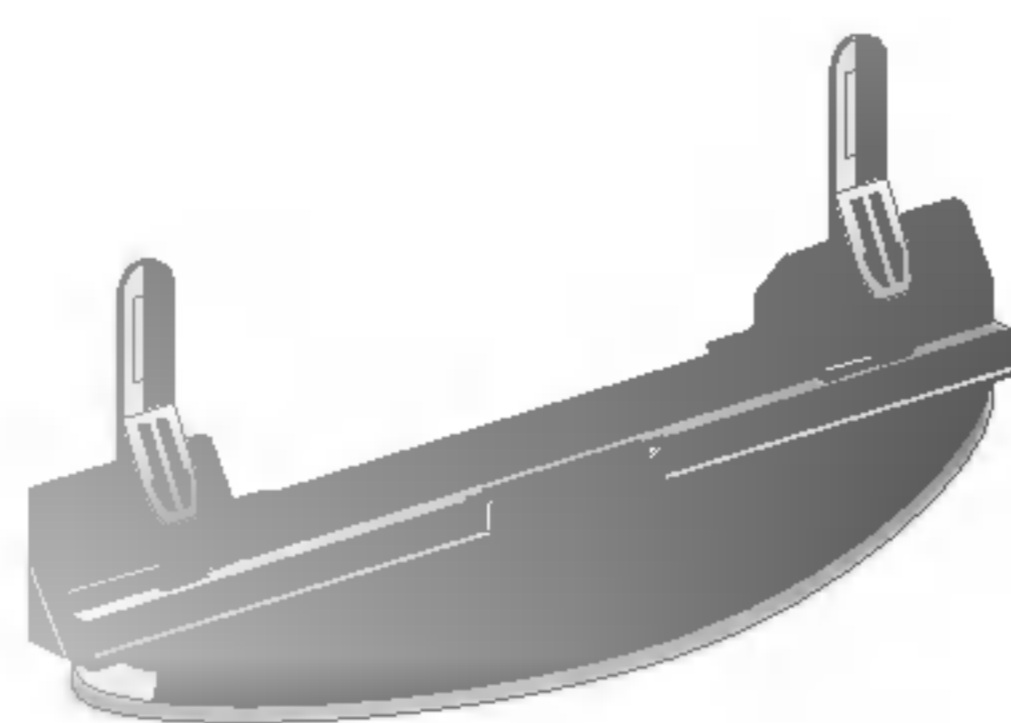

60PZ9M/H series



Video cables

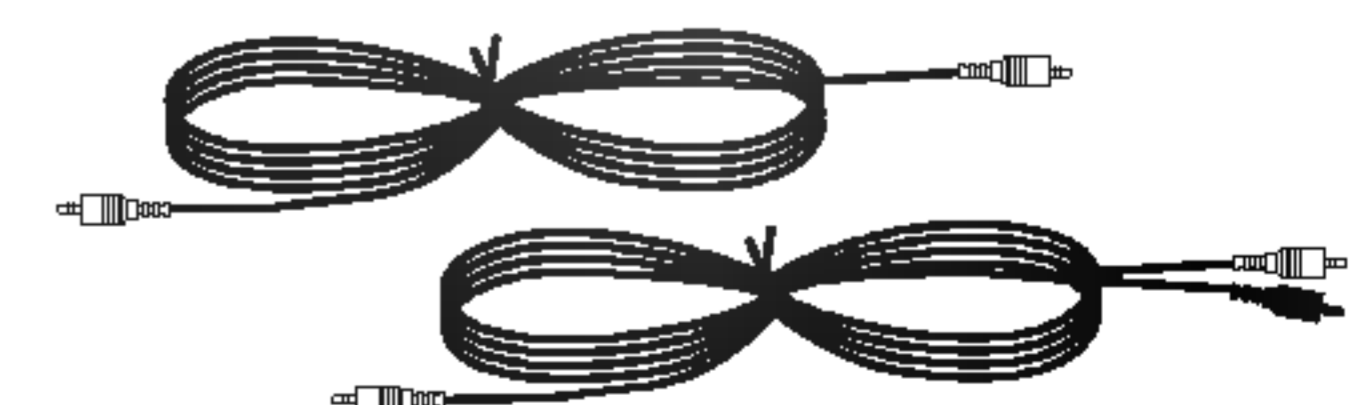

Audio cables

Installation Options

- The set can be installed in different ways such as on a wall, or on a desktop etc.
- Install this set only in a location where adequate ventilation is available.
- This set is designed so that it can be mounted either horizontally or vertically.

Wall Mount: Horizontal Installation

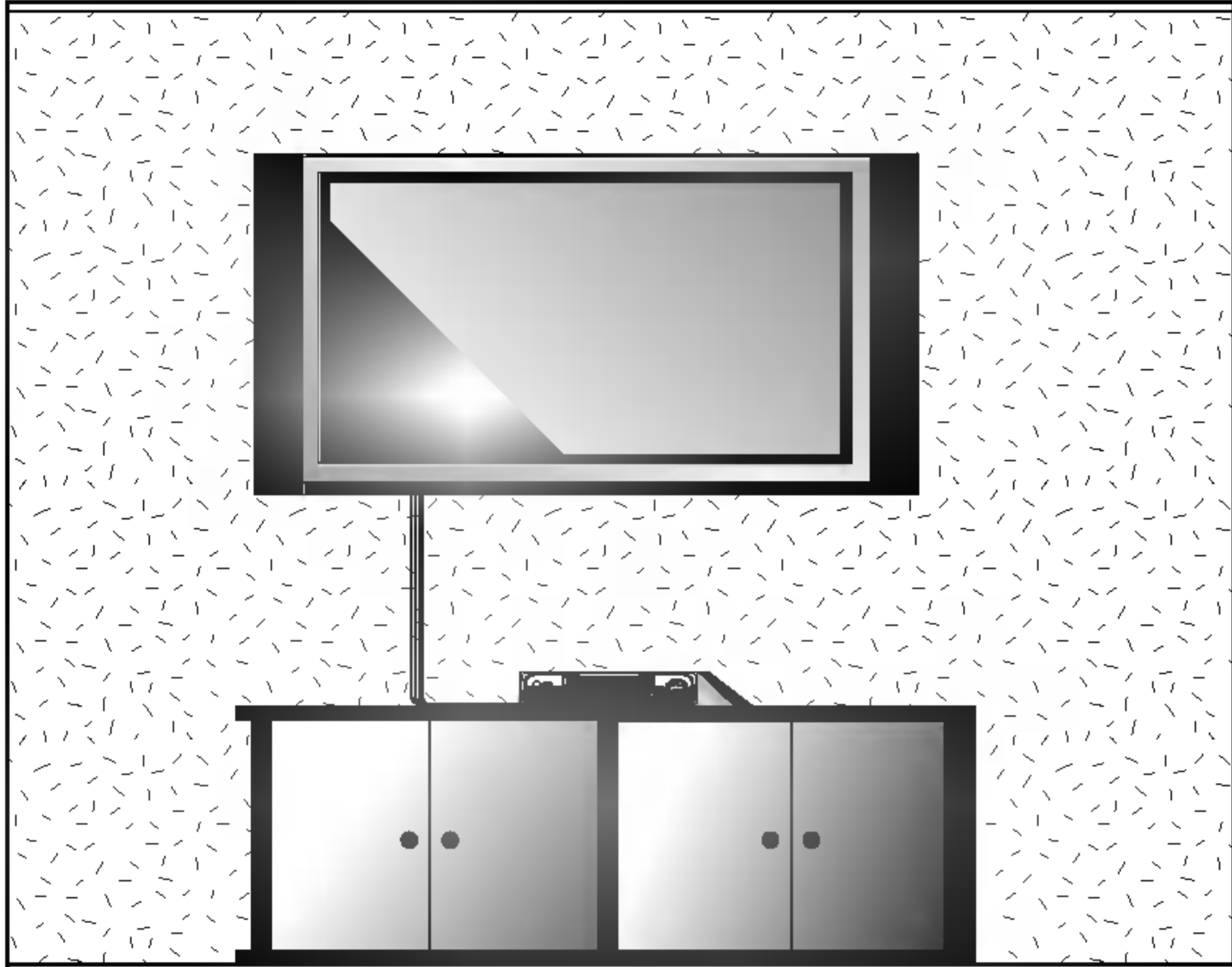

- The set can be installed on a wall as shown above. (For further information, refer to the optional 'Wall Mounting Bracket Installation and Setup Guide'.)
- Speakers are optional, and are shown for illustration only.

Wall Mount: Vertical Installation

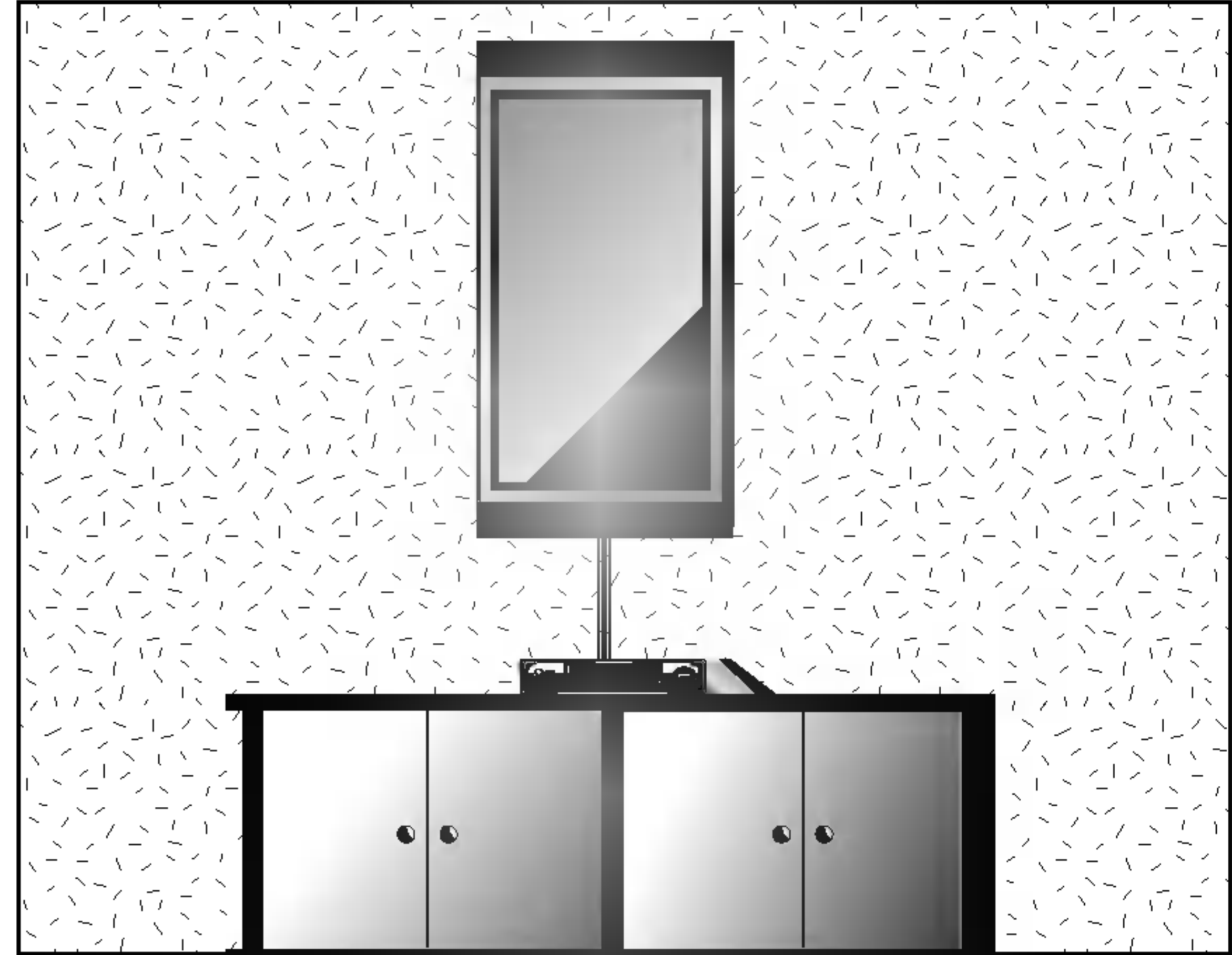

- The set can be installed vertically on the wall as shown above. (For further information, refer to the optional 'Wall Mounting Bracket Installation and Setup Guide'.)
 Caution: When installing the set vertically, the front panel controls must be in the left-down side position as shown above.
- Speakers are optional, and are shown for illustration only.
- **Note:** To use the set in a vertical orientation, the source's image must also be in a vertical format.

Desktop Pedestal Installation

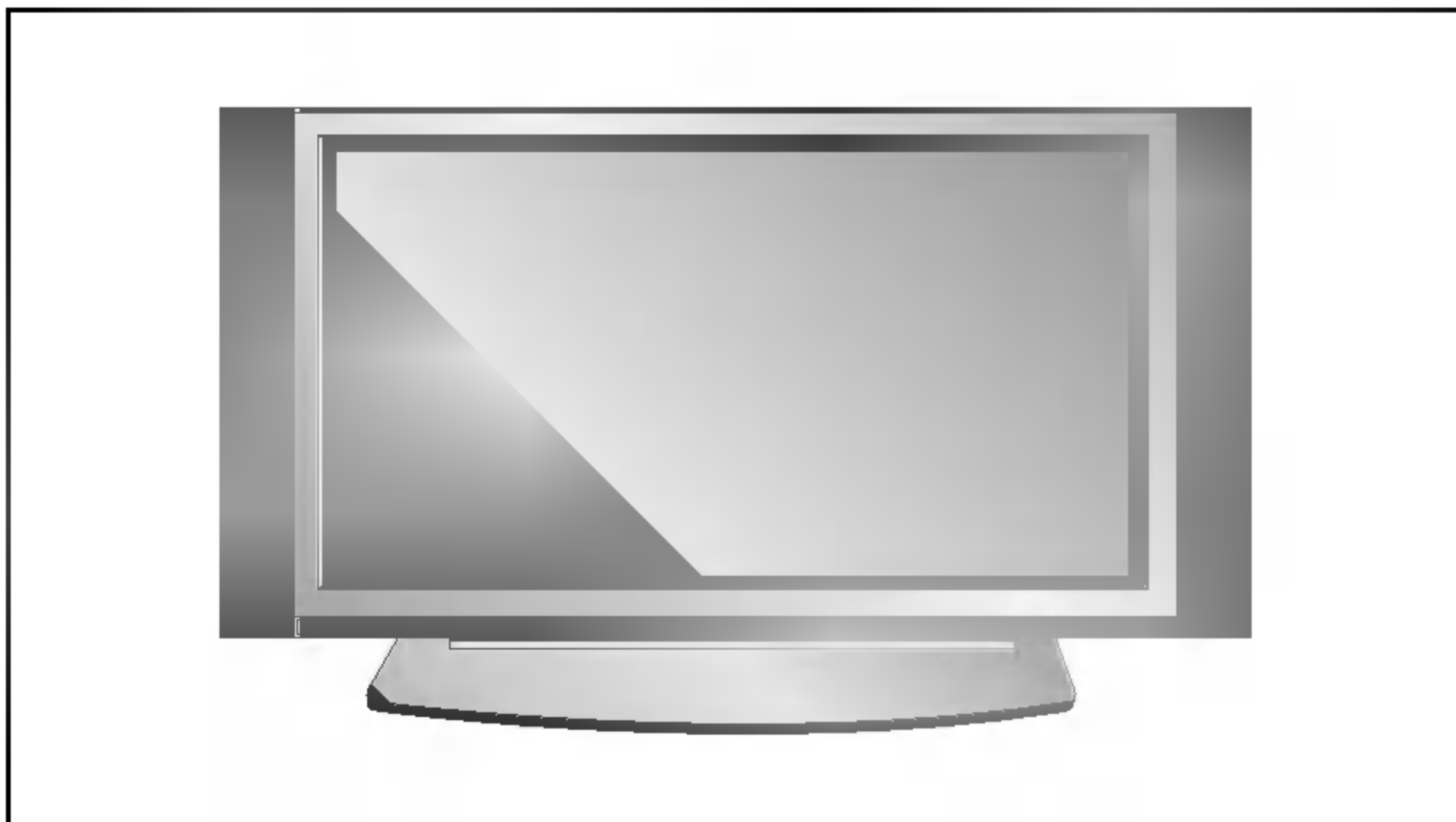

- The set can be mounted on a desk as shown above. (For further information, refer to the optional 'Desktop Stand Installation and Setup Guide'.)
- Speakers and speaker stands shown are optional, and are shown for example only.

To Mount on a Wall

Wall mount minimum allowable clearances for adequate ventilation.

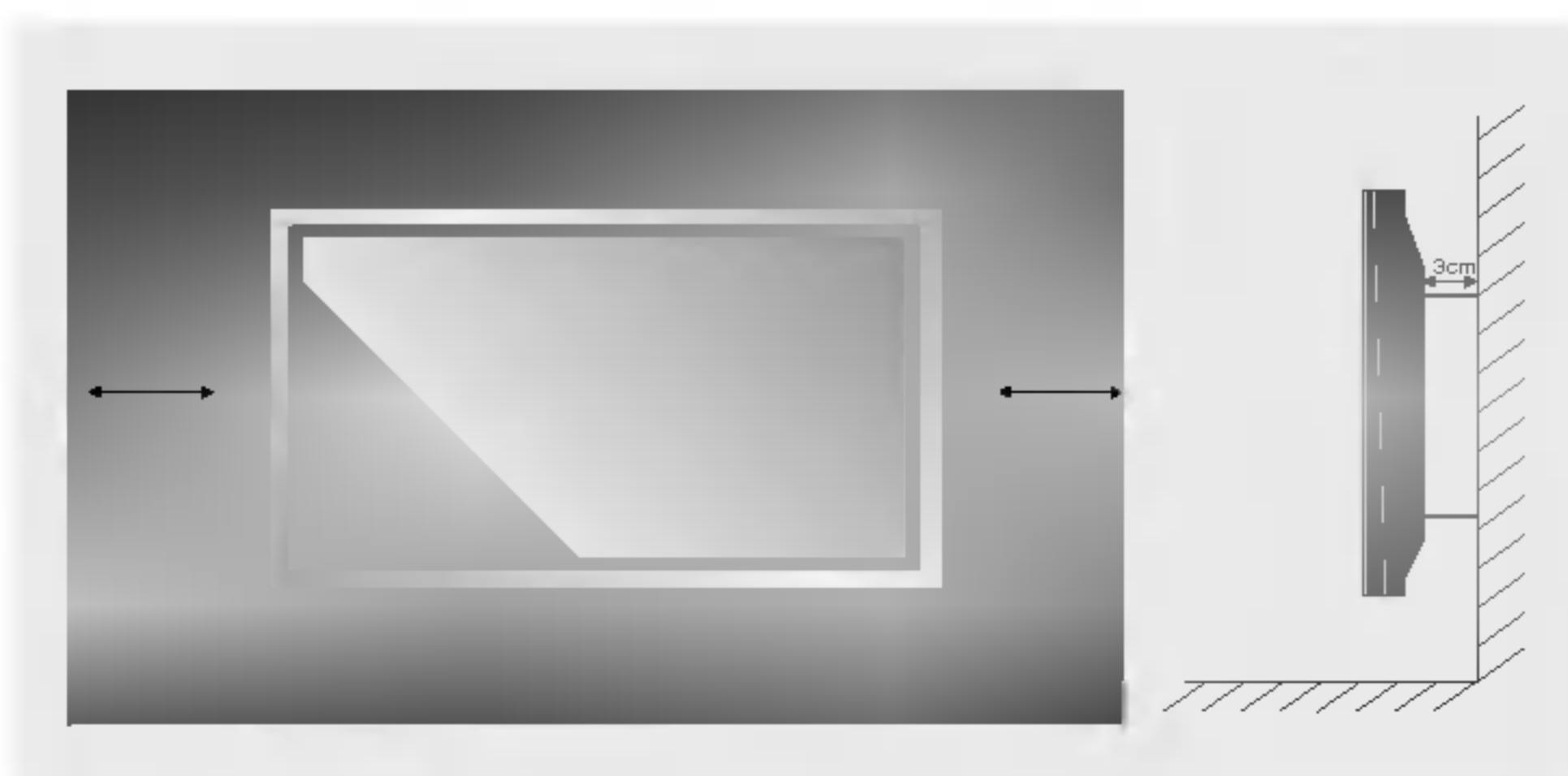

To Install on a Desktop

Pedestal mount minimum allowable clearances for adequate ventilation.

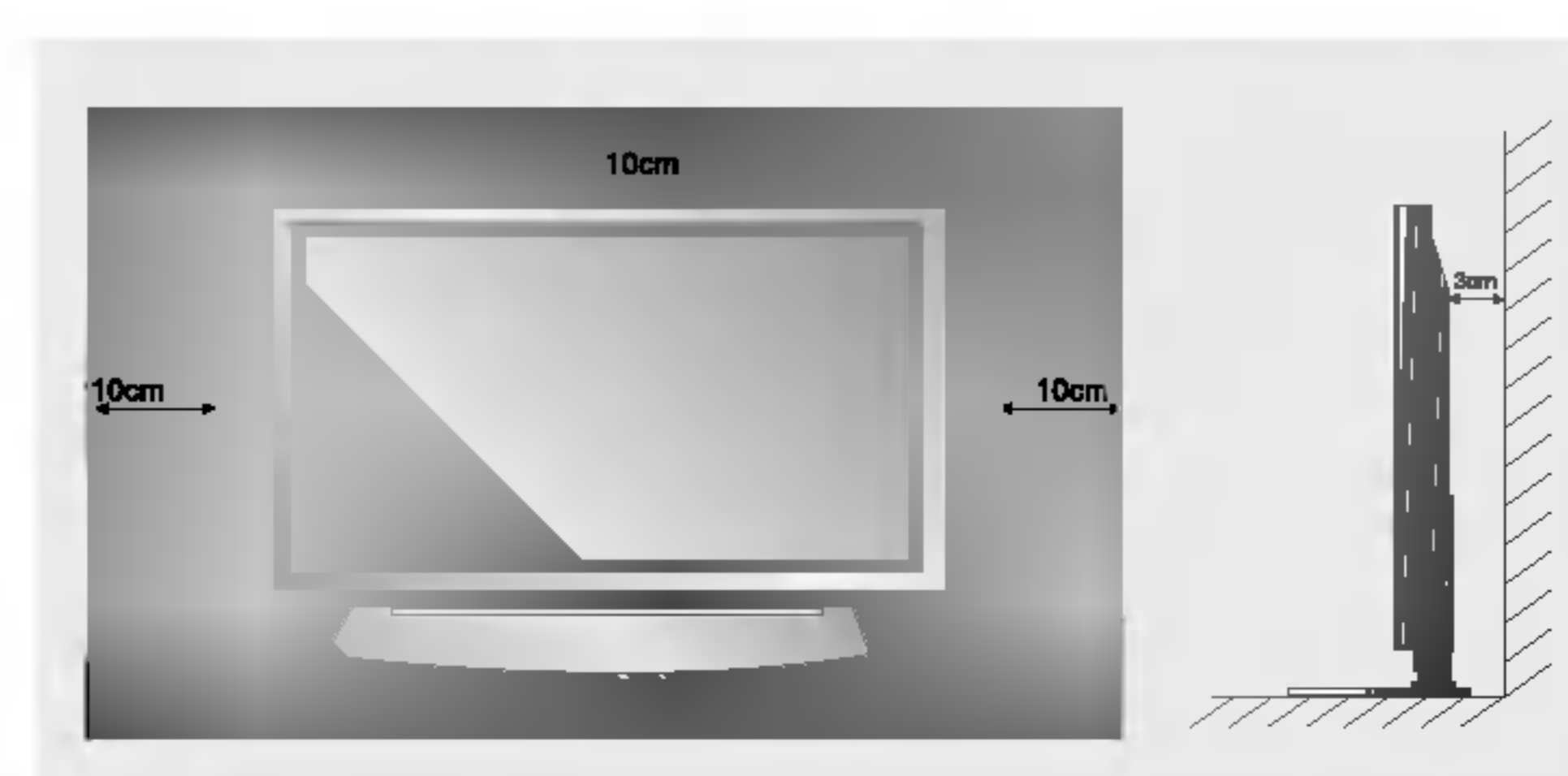

Turning on the Set

- When using the remote control, aim it at its sensor on the set.

42/50PM1M/H series / 60PZ9M/H series



1. Connect power cord correctly.
2. Press the **⏻ ON/OFF** button on the set. At this moment, the set is switched to standby mode. Press the **INPUT SELECT** button on the set or press the **POWER, INPUT, MULTIMEDIA, ▲ / ▼** or **NUMBER** button on the remote control and then the set will switch on.



1. If the set was turned off with the **⏻ ON/OFF** button on the set
 - Press the **⏻ ON/OFF** button on the set to turn the set on.
2. If the set was turned off with the remote control and the **⏻ ON/OFF** button on the set
 - Press the **⏻ ON/OFF** button on the set and then press the **INPUT SELECT** button on the set or press the **POWER, INPUT, MULTIMEDIA, ▲ / ▼** or **NUMBER** button on the remote control to turn the set on.

42PM3MV/H series



1. Connect power cord correctly, the set is switched to standby mode.
2. Press the **⏻ / I, INPUT SELECT** or **▲ / ▼** button on the set or press the **POWER, INPUT, MULTIMEDIA, ▲ / ▼** or **NUMBER** button on the remote control and then the set will switch on.



If the set was turned off with the remote control power button and the **⏻ / I** button on the set

- Press the **⏻ / I, INPUT SELECT** or **▲ / ▼** button on the set or press the **POWER, INPUT, MULTIMEDIA, ▲ / ▼** or **NUMBER** button on the remote control to turn the set on.

On-Screen Menu Language Selection (option)

- The menus can be shown on the screen in the selected language. First select your language.
 1. Press the **MENU** button and then use **▲ / ▼** button to select the **SPECIAL** menu.
 2. Press the **▶** button and then use **▲ / ▼** button to select **Language**.
 3. Press the **▶** button and then use **▲ / ▼** button to select your desired language.
From this point on, the on-screen menus will be shown in the language of your choice.
 4. Repeatedly press the **MENU** button to return to normal viewing.

Picture Menu Options

PSM (Picture Status Memory)

- This function adjusts the set to the best picture appearance.
- When adjusting picture options (contrast, brightness, colour, sharpness and tint (NTSC input only)) manually, PSM is automatically changed to **User**.

1. Press the **PSM** button

- Each press of the **PSM** button changes the screen display as shown below.



- You can also select **Dynamic**, **Standard**, **Mild** or **User** in the PICTURE menu.
- Picture options **Dynamic**, **Standard** and **Mild** are preset and programmed for good picture quality at the factory and cannot be changed.

CSM (Color Status Memory)

- To initialize values (reset to default settings), select the **Normal** option.

1. Press the **MENU** button and then use **▲ / ▼** button to select the PICTURE menu.

2. Press the **▶** button and then use **▲ / ▼** button to select **CSM**.

3. Press the **▶** button and then use **▲ / ▼** button to select the desired colour temperature.

4. Repeatedly press the **MENU** button to return to normal viewing.

- Each press of **▲ / ▼** button changes the screen display as shown below.

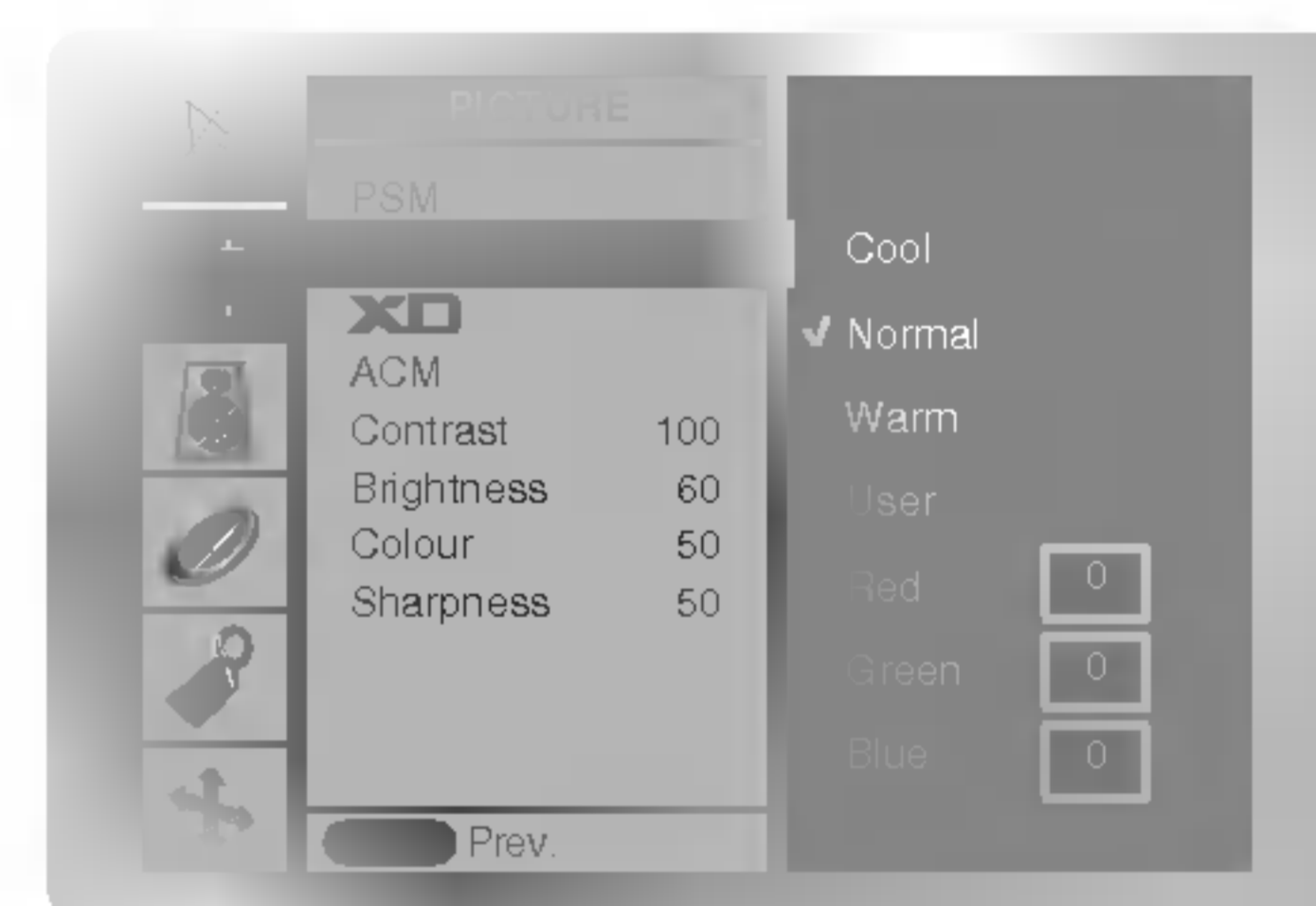

Manual Colour Temperature Control

- You can adjust red, green, or blue to any colour temperature you prefer.

1. Press the **MENU** button and then use **▲ / ▼** button to select the PICTURE menu.

2. Press the **▶** button and then use **▲ / ▼** button to select **CSM**.

3. Press the **▶** button and then use **▲ / ▼** button to select **User**.

4. Press the **▶** button and then use **◀ / ▶** button to make appropriate adjustments.

5. Repeatedly press the **MENU** button to return to normal viewing.

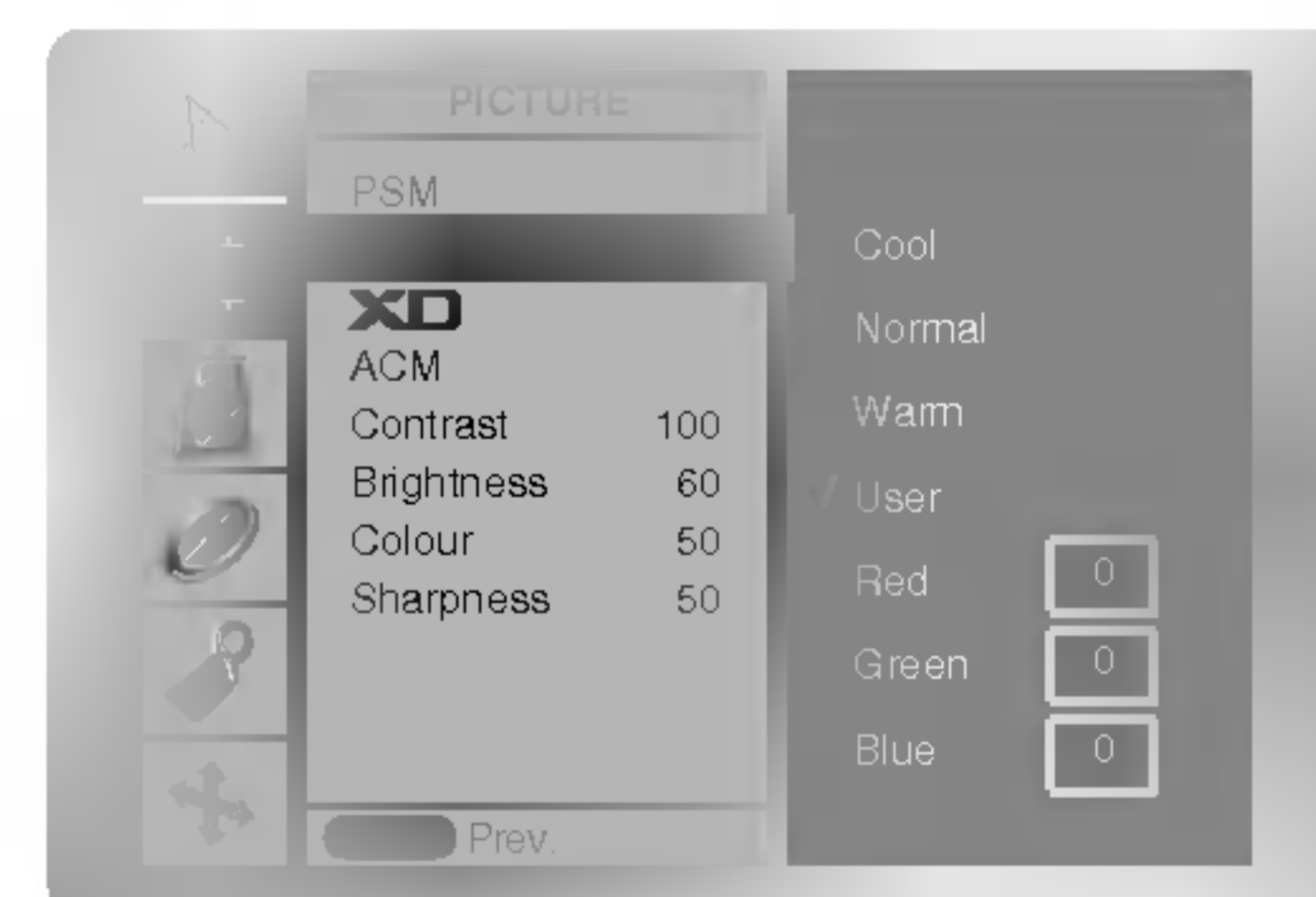

XD

- You can enjoy the vivid and hi-definition picture with LG's excellent Digital Reality processor technology.
- It's not available to use this function in RGB[PC], HDMI[PC] mode.
- When selecting picture options (**Dynamic**, **Standard** and **Mild**) in PICTURE menu, **XD** is automatically changed to **On**.

1. Press the **MENU** button and then use **▲ / ▼** button to select the PICTURE menu.

2. Press the **▶** button and then use **▲ / ▼** button to select **XD**.

3. Press the **▶** button and then use **▲ / ▼** button to select **On** or **Off**.

4. Repeatedly press the **MENU** button to return to normal viewing.



Picture Menu Options

sRGB (RGB[PC], HDMI[PC] mode only)

- When the set was connected to external equipment with sRGB function, It's adjusted a colour difference to display the equal image each other.

1. Press the **MENU** button and then use ▲ / ▼ button to select the PICTURE menu.
2. Press the ► button and then use ▲ / ▼ button to select **sRGB**.
3. Press the ► button and then use ▲ / ▼ button to select **On** or **Off**.
4. Repeatedly press the **MENU** button to return to normal viewing.



ACM (Active Color Management)

- Adjust the **ACM** to select the desired skin colour option.
- This function is not available for use in RGB[PC], HDMI[PC] mode.
- It's not available to use this function in **XD Off** mode.

1. Press the **MENU** button and then use ▲ / ▼ button to select the PICTURE menu.
2. Press the ► button and then use ▲ / ▼ button to select **ACM**.
3. Press the ► button and then use ◀ / ▶ button to make appropriate adjustments.
4. Repeatedly press the **MENU** button to return to normal viewing.



Manual Picture Control

- You can adjust picture contrast, brightness, colour, sharpness and tint (NTSC input only) to the levels you prefer.
- It's not available to use colour, sharpness function in RGB[PC], HDMI[PC] mode.
- In the broadcasting system PAL/SECAM, the picture item Tint doesn't work.

1. Press the **MENU** button and then use ▲ / ▼ button to select the PICTURE menu.
2. Press the ► button and then use ▲ / ▼ button to select the desired picture option.
3. Press the ► button and then use ◀ / ▶ button to make appropriate adjustments.
4. Repeatedly press the **MENU** button to return to normal viewing.





Sound Menu Options

SSM (Sound Status Memory)

- This function lets you enjoy the best sound without any special adjustment because the set automatically selects the appropriate sound option based on the program content.
- When adjusting sound options (treble and bass) manually, SSM is automatically changed to **User**.

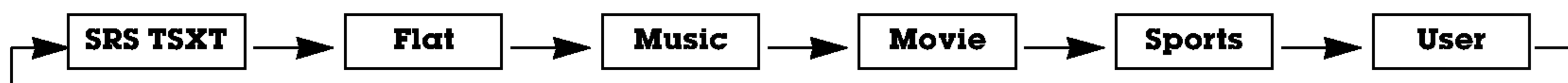
1. Press the **SSM** button.
2. Press the **SSM** button to select your desired sound.



- You can also select **SRS TSXT**, **Flat**, **Music**, **Movie**, **Sports** or **User** in the SOUND menu.
 - The sound **SRS TSXT**, **Flat**, **Music**, **Movie** and **Sports** are programmed for good sound reproduction at the factory and cannot be changed.
-  is a trademark of SRS Labs, Inc.
 - TruSurround XT technology is incorporated under license from SRS Labs, Inc.

BBE

- BBE High Definition Sound restores clarity and presence for better speech intelligibility and musical realism.

1. Press the **MENU** button and then use **▲ / ▼** button to select the SOUND menu.
2. Press the **▶** button and then use **▲ / ▼** button to select **BBE**.
3. Press the **▶** button and then use **▲ / ▼** button to select **On** or **Off**.
4. Repeatedly press the **MENU** button to return to normal viewing.

BBE Manufactured under license from BBE Sound, Inc.

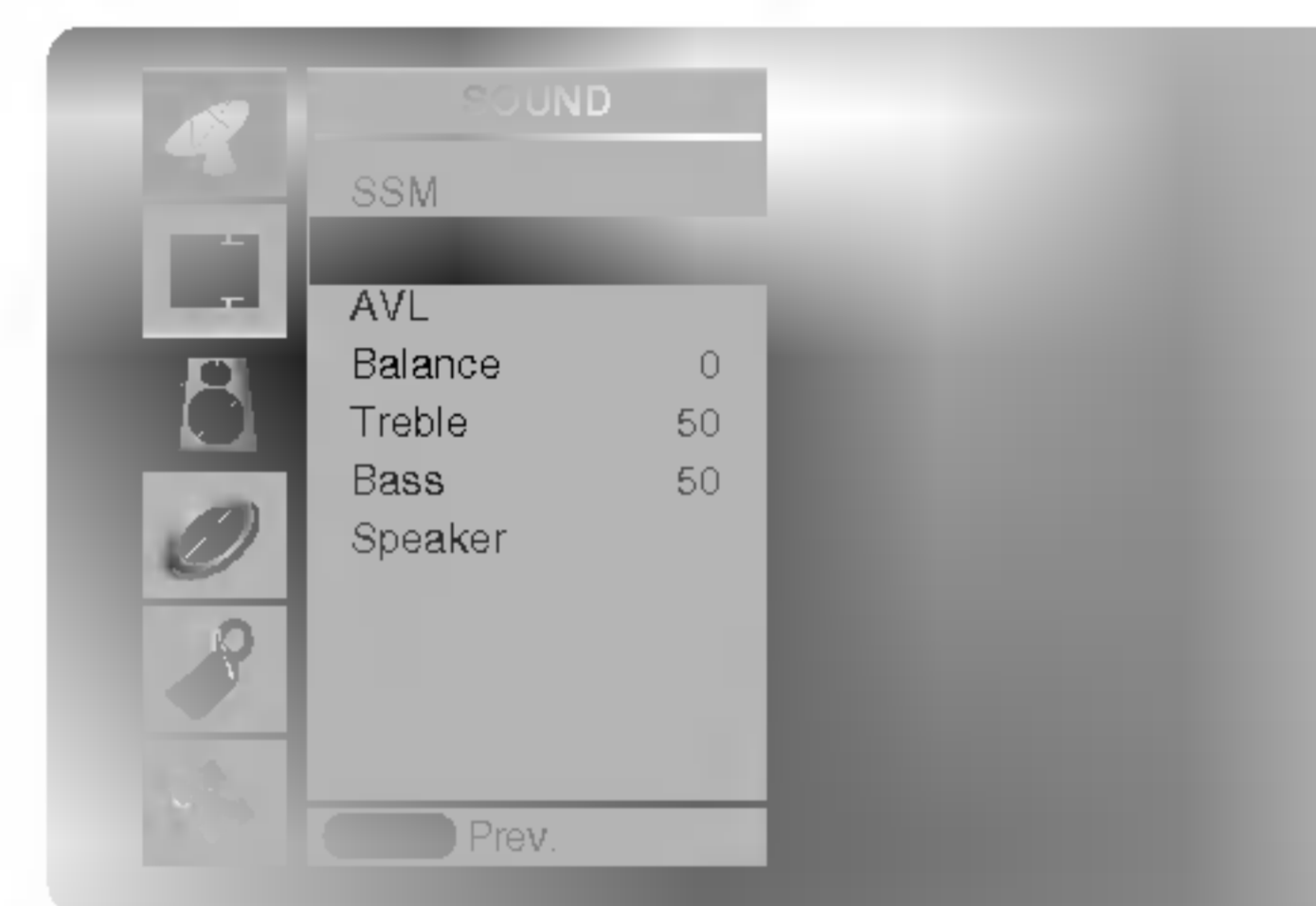

AVL (Auto Volume Leveler)

- This feature maintains an equal volume level; even if you change channels.

1. Press the **MENU** button and then use **▲ / ▼** button to select the SOUND menu.
2. Press the **▶** button and then use **▲ / ▼** button to select **AVL**.
3. Press the **▶** button and then use **▲ / ▼** button to select **On** or **Off**.
4. Repeatedly press the **MENU** button to return to normal viewing.

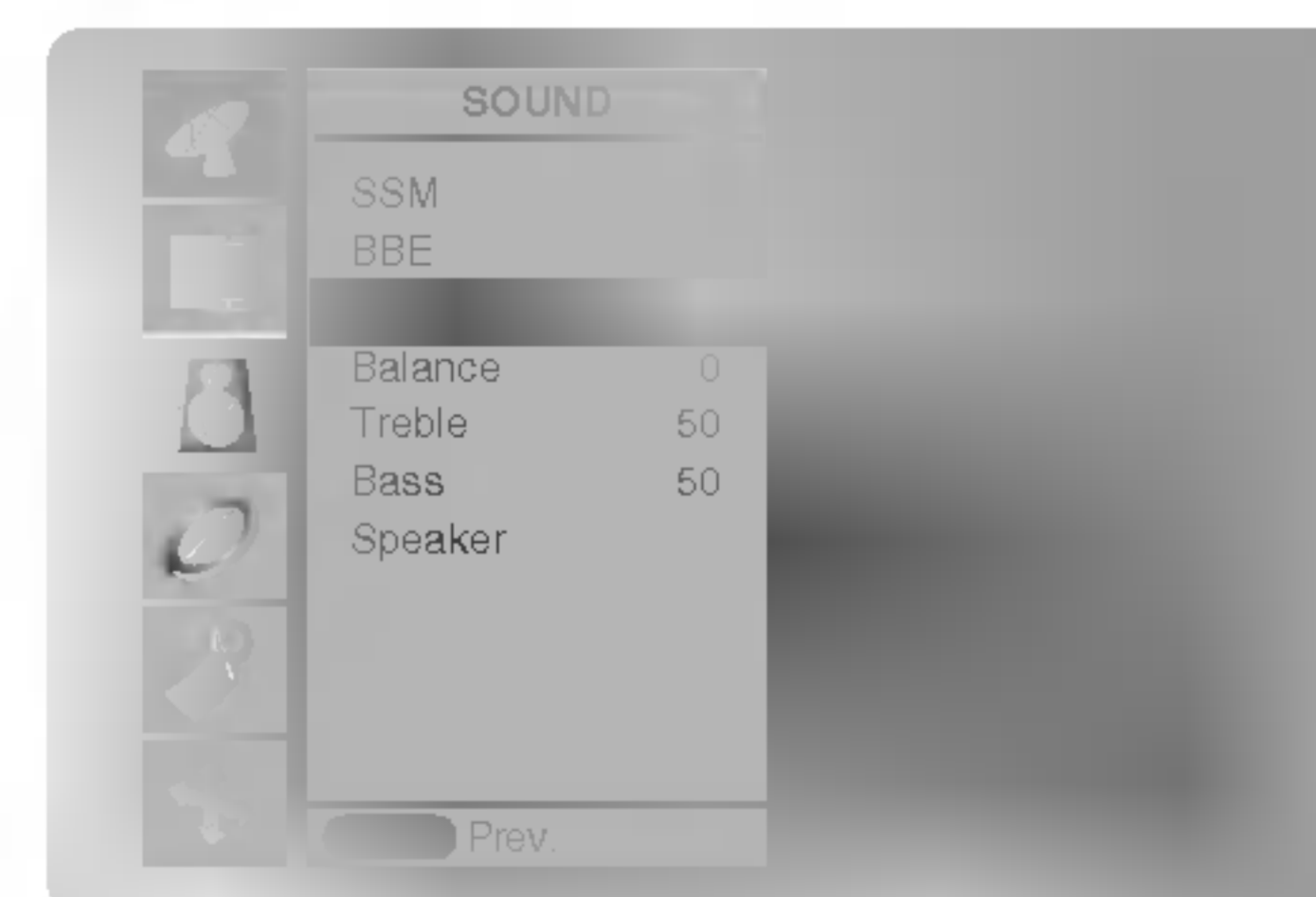

Sound Menu Options

Adjusting Sound Control

1. Press the **MENU** button and then use ▲ / ▼ button to select the SOUND menu.
2. Press the ► button and then use ▲ / ▼ button to select the desired sound item.
3. Press the ► button and then use ◀ / ▶ button to make appropriate adjustments.
4. Repeatedly press the **MENU** button to return to normal viewing.

Note : Treble, Bass or BBE aren't suitable to use **SRS TSXT**.

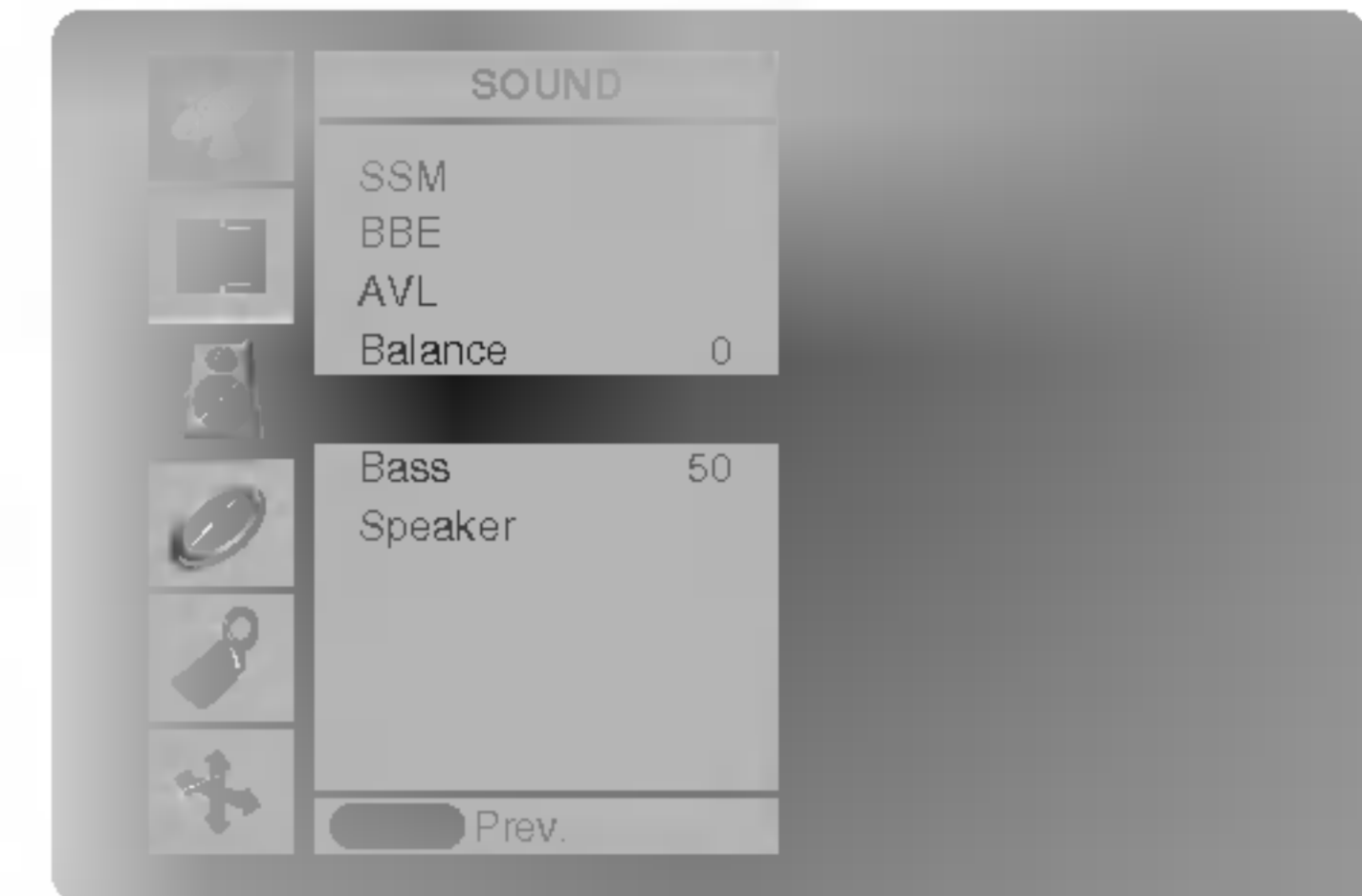

Speaker

- You can adjust internal speaker status.
- In COMPONENT, RGB[PC] and HDMI[PC] mode, speaker/variable audio can be output even though there is no video signal.

1. Press the **MENU** button and then use ▲ / ▼ button to select the SOUND menu.
2. Press the ► button and then use ▲ / ▼ button to select **Speaker**.
3. Press the ► button and then use ▲ / ▼ button to select **On** or **Off**.
4. Repeatedly press the **MENU** button to return to normal viewing.

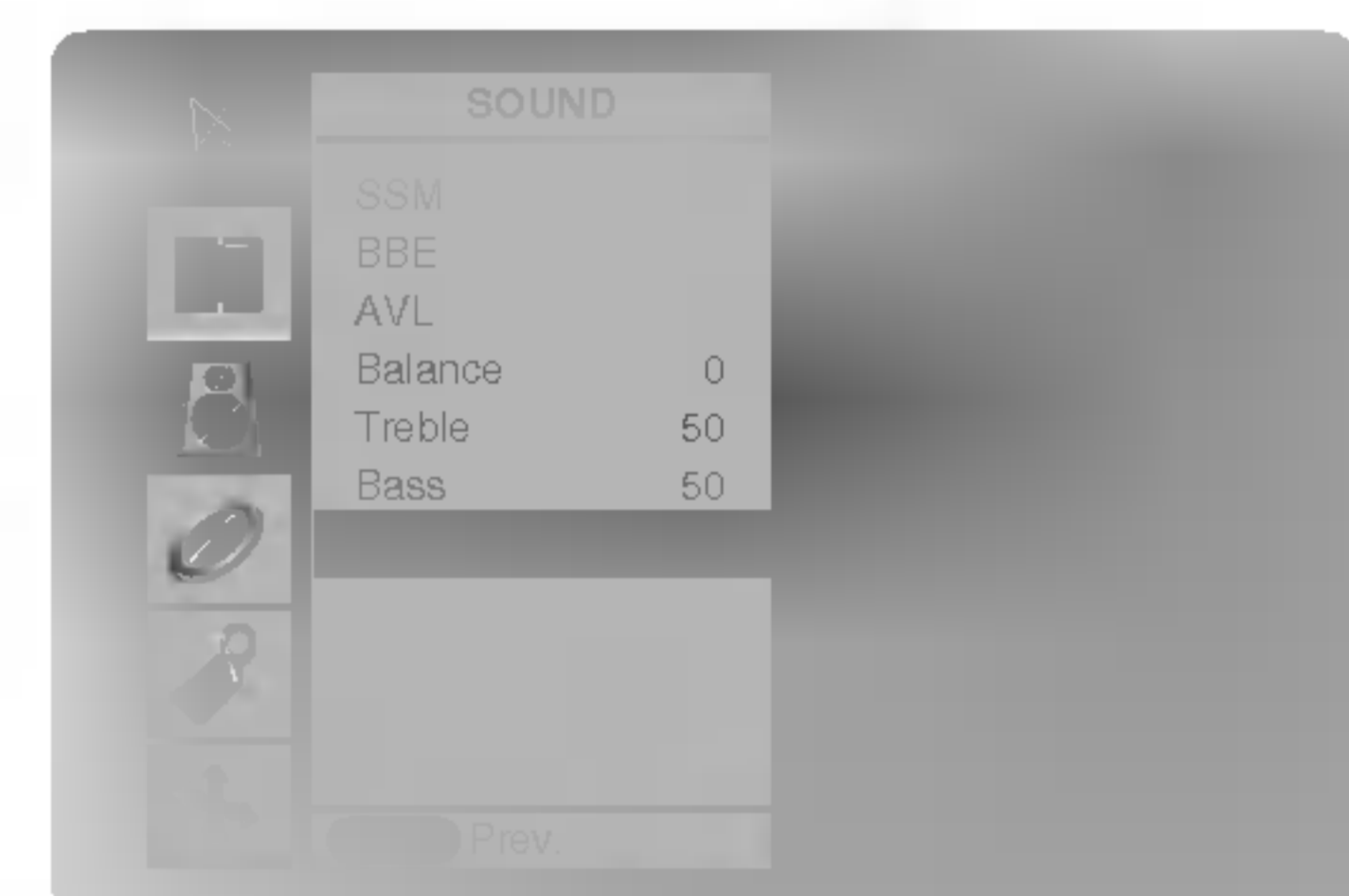

Time Menu Options

Setting the Clock

- If current time setting is erased by a power failure or if the set is unplugged, reset the clock.

 1. Press the **MENU** button and then use ▲ / ▼ button to select the TIME menu.
 2. Press the ► button and then use ▲ / ▼ button to select **Clock**.
 3. Press the ► button and then use ▲ / ▼ button to adjust the hour.
 4. Press the ► button and then use ▲ / ▼ button to adjust the minute.
 5. Repeatedly press the **MENU** button to return to normal viewing.

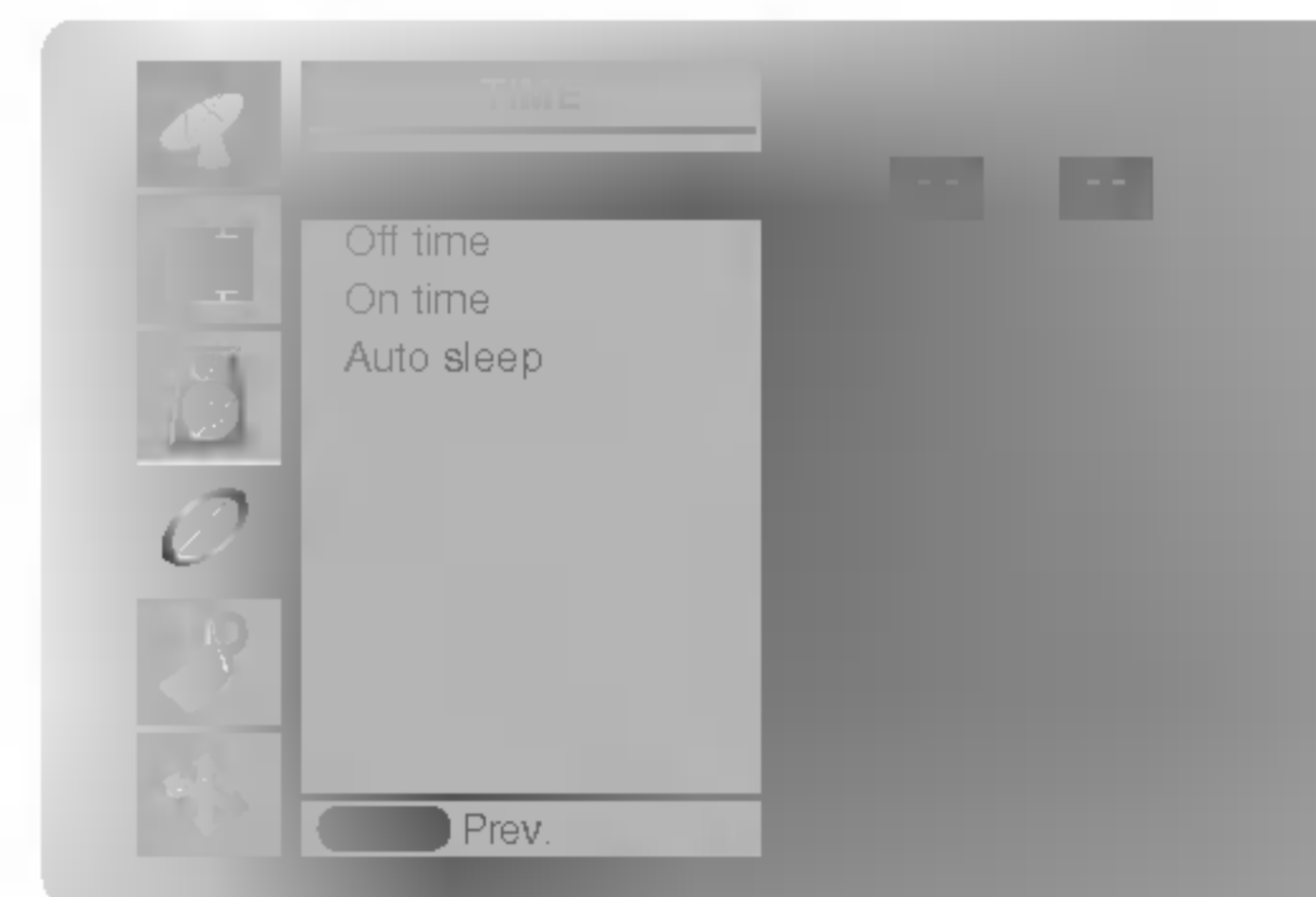

Setting the On/Off Timer

- Timer function operates only if current time has been already set.
- Off Timer function overrides on Timer function if they are set to the same time.
- The set must be in standby mode for the On Timer to work.

 1. Press the **MENU** button and then use ▲ / ▼ button to select the TIME menu.
 2. Press the ► button and then use ▲ / ▼ button to select **Off time** or **On time**.
 3. Press the ► button and then use ▲ / ▼ button to select **On**.
 4. Press the ► button and then use ▲ / ▼ button to adjust the hour.
 5. Press the ► button and then use ▲ / ▼ button to adjust the minute.
 6. **Only On time function**; Press the ► button and then use ▲ / ▼ button to adjust volume level.
 7. Repeatedly press the **MENU** button to return to normal viewing.

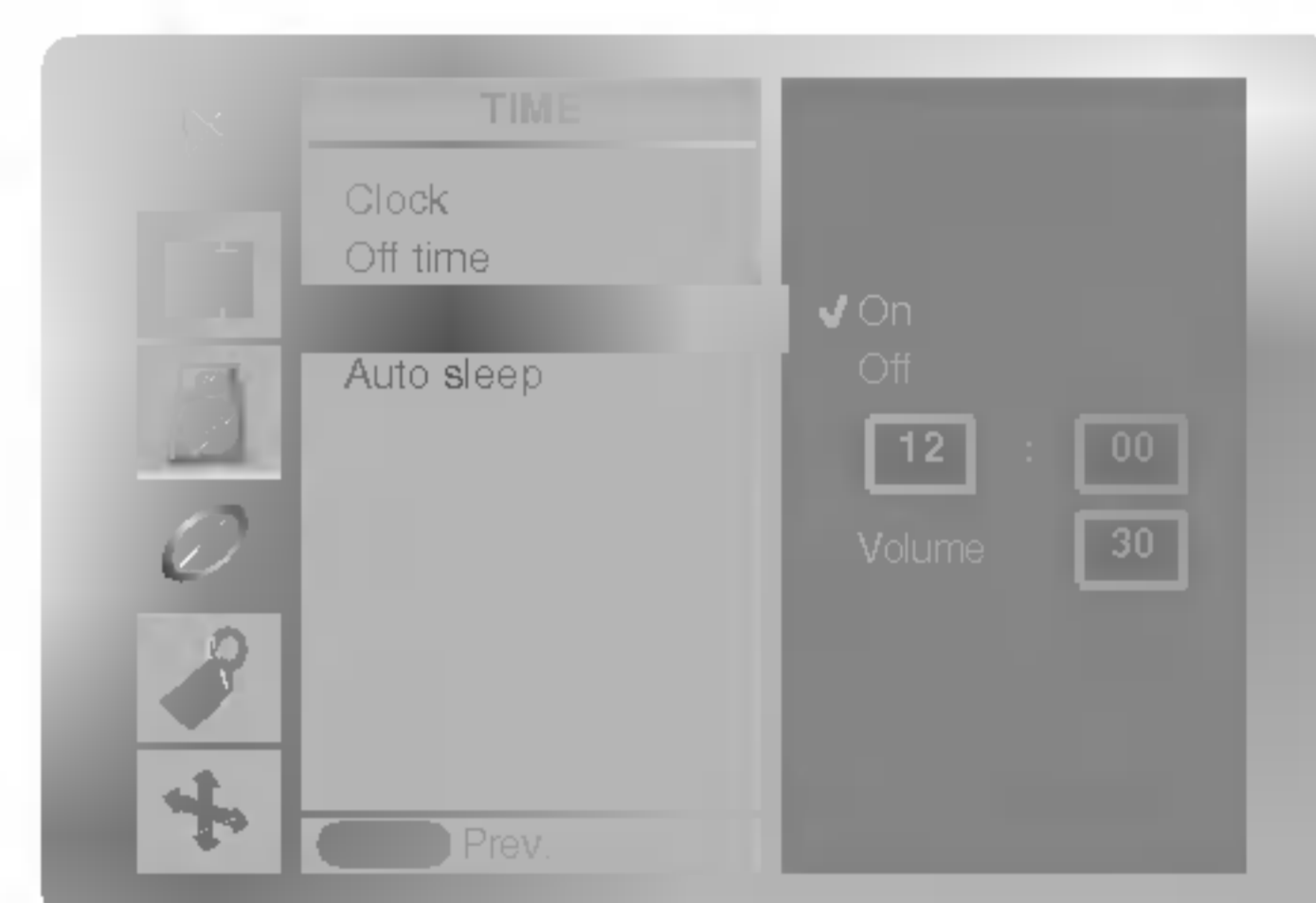

- To cancel **Off/On time** function
Press the ▲ / ▼ button to select **Off** in step 3.

Auto Sleep

- If there is no input signal, the set turn off automatically after 10 minutes.

 1. Press the **MENU** button and then use ▲ / ▼ button to select the TIME menu.
 2. Press the ► button and then use ▲ / ▼ button to select **Auto sleep**.
 3. Press the ► button and then use ▲ / ▼ button to select **On** or **Off**.
 4. Repeatedly press the **MENU** button to return to normal viewing.

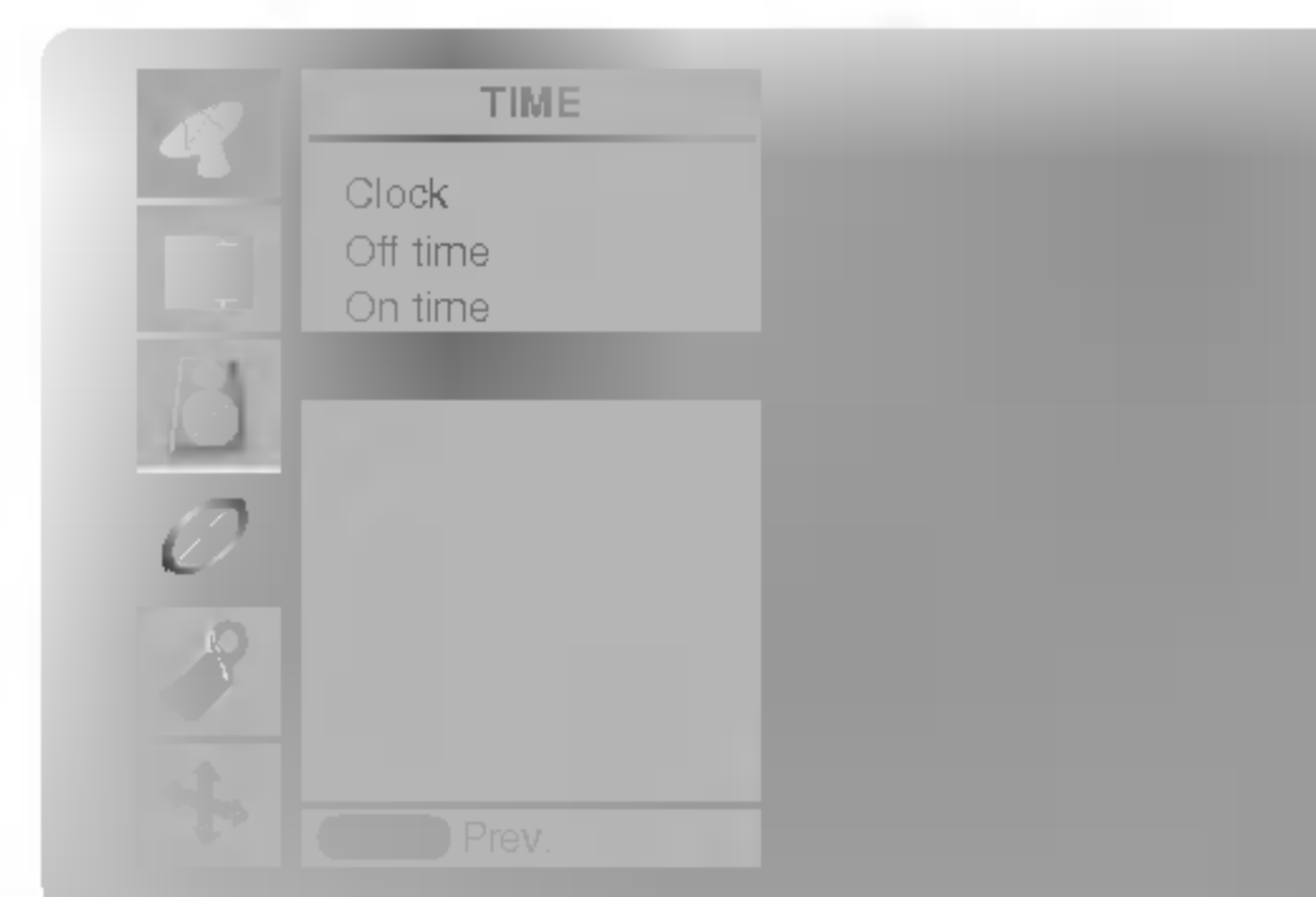

Sleep Timer

- Sleep timer turns the set off at the preset time.
- Press the **SLEEP** button to select the number of minutes. The display --- **Min** will appear on the screen, followed by **10, 20, 30, 60, 90, 120, 180** and **240** minutes. The timer begins to count down from the number of minutes selected.

- a. To check the remaining sleep time, press the **SLEEP** button once.
- b. To cancel the sleep time, repeatedly press the **SLEEP** button until the display --- **Min** appears.
- c. If you turn the set off after setting the sleep timer, the setting will be erased.

Special Menu Options

Child Lock

- The set can be set up so that it can only be used with the remote control.
 1. Press the **MENU** button and then ▲ / ▼ button to select the **SPECIAL** menu.
 2. Press the ► button and then ▲ / ▼ button to select **Child lock**.
 3. Press the ► button and then ▲ / ▼ button to select **On** or **Off**.
 4. Repeatedly press the **MENU** button to return to normal viewing.

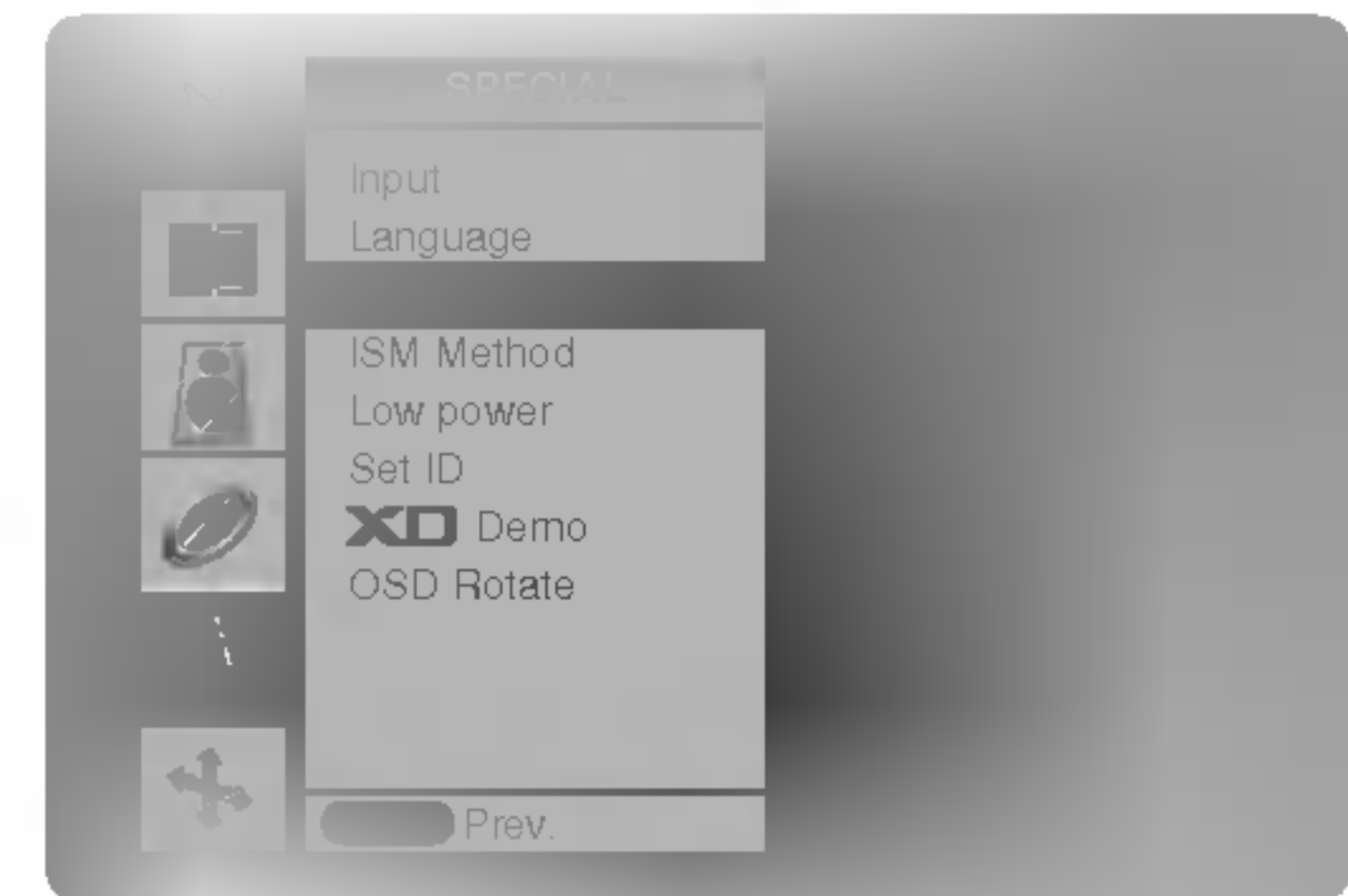

- This set programmed to remember which option it was last set to even if you turn the set off.
- In **Child lock 'On'**, if the set is turned off, press the **INPUT SELECT** button on the set or **POWER** or **INPUT** button on the remote control.
- With the **Child lock On**, the display '▲ Child lock on' appears on the screen if any button on the front panel is pressed while viewing the set.

ISM (Image Sticking Minimization) Method

- Frozen still picture from a PC/video game displayed on the screen for prolonged periods will result in an ghost image remaining even when you change the image. Avoid allowing a fixed image to remain on the set's screen for a long period of time.

1. Press the **MENU** button and then use ▲ / ▼ button to select the **SPECIAL** menu.
2. Press the ► button and then ▲ / ▼ button to select **ISM Method**.
3. Press the ► button and then ▲ / ▼ button to select either **Normal**, **White wash**, **Orbiter** or **Inversion**. If you unnecessary to set this function, set **Normal**.

- **White Wash :**

White Wash removes permanent images from the screen.

Note: An excessive permanent image may be impossible to clear entirely with White Wash.

- **Orbiter :**

Orbiter may help prevent ghost images. However, it is best not to allow any fixed image to remain on the screen. To avoid a permanent image on the screen, the screen will move every 2 minutes.

- **Inversion :**

This is the function to invert the panel color of the screen. The panel color is automatically inverted every 30 minutes.

4. Repeatedly press the **MENU** button to return to normal viewing.

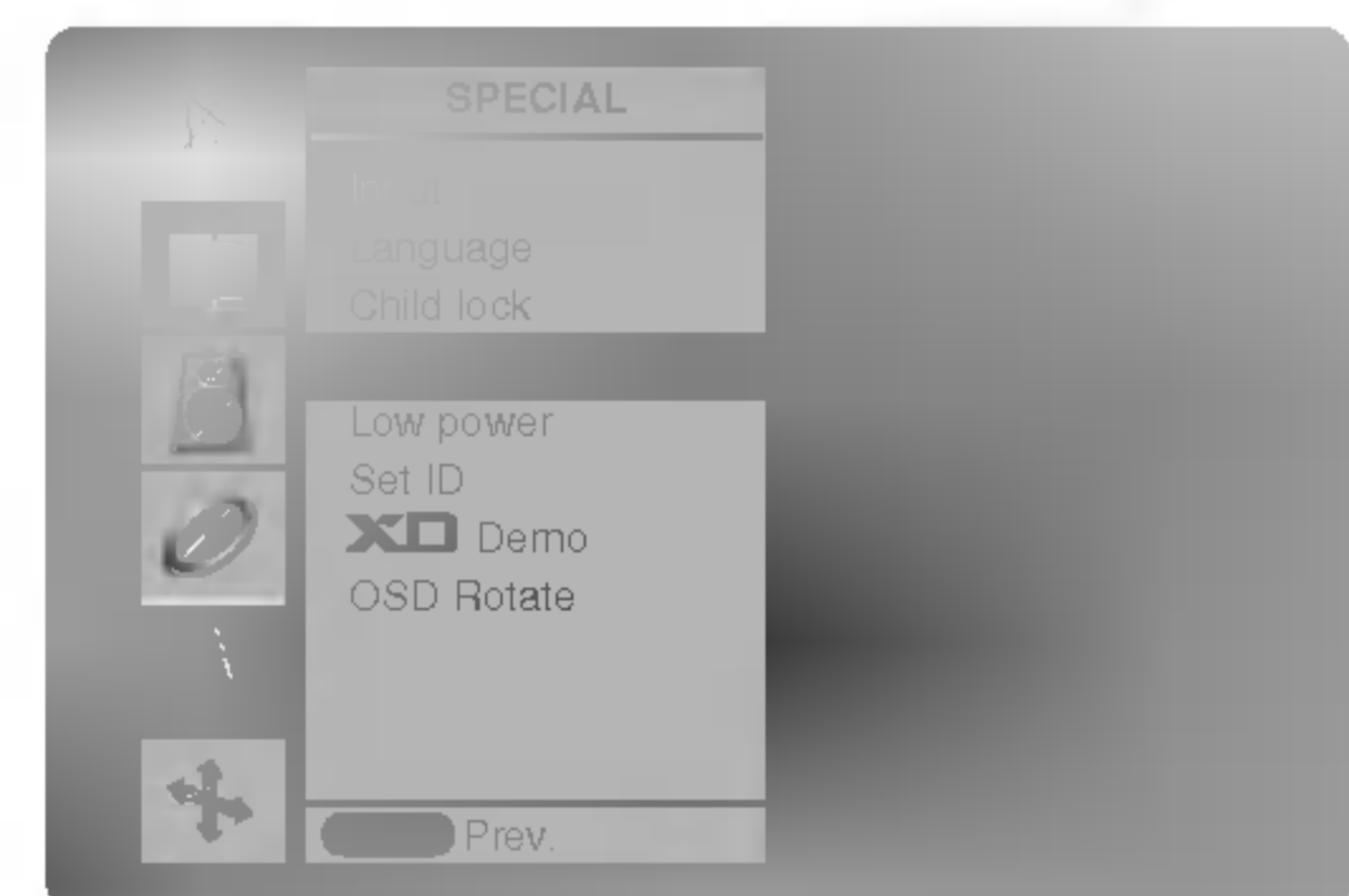

Low Power

- This is the function to reduce the power consumption of the set.
- 1. Press the **MENU** button and then use ▲ / ▼ button to select the **SPECIAL** menu.
- 2. Press the ► button and then use ▲ / ▼ button to select **Low power**.
- 3. Press the ► button and then use ▲ / ▼ button to select **On** or **Off**.
- 4. Repeatedly press the **MENU** button to return to normal viewing.

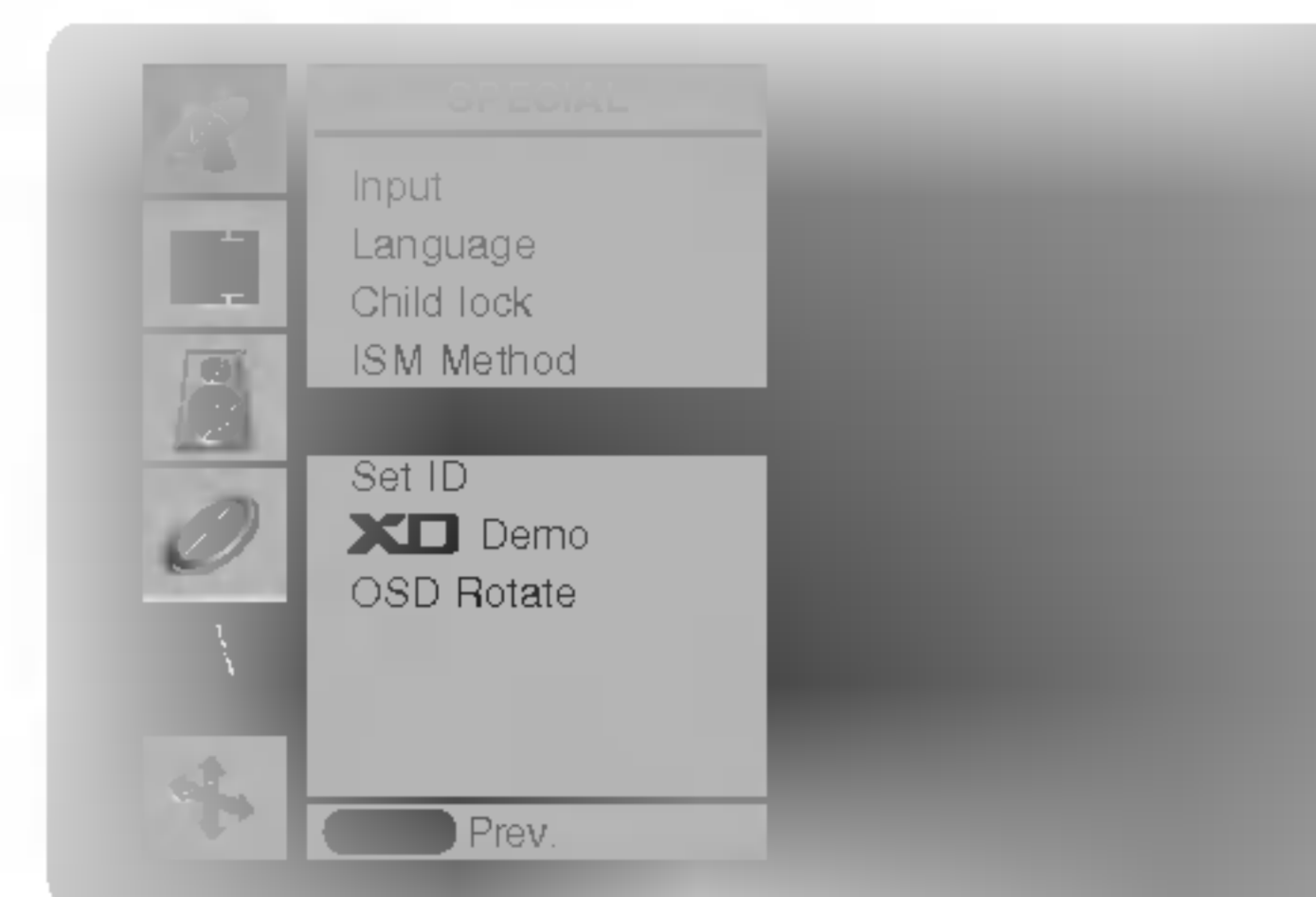

X.D Demo

- Use it to see the difference between X.D demo on and X.D Demo off.
- This function is not available for use in RGB[PC], HDMI[PC] mode.
- It's not available to use this function in **Rotate** mode.
- 1. Press the **MENU** button and then use ▲ / ▼ button to select the **SPECIAL** menu.
- 2. Press the ► button and then use ▲ / ▼ button to select **X.D Demo**.
- 3. Press the ► button to begin **X.D Demo**.
- 4. To stop **X.D Demo**, press the **MENU** button.

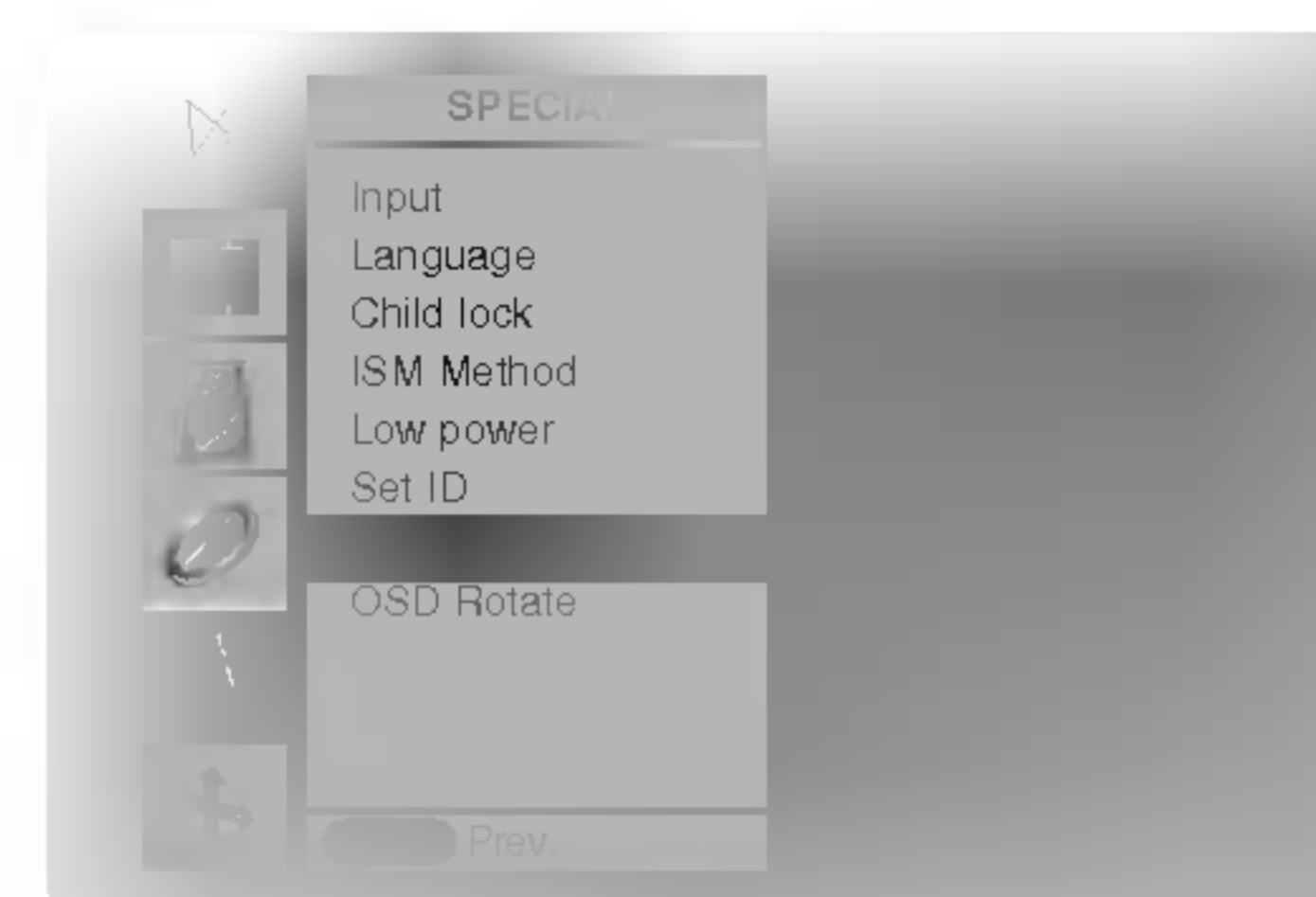

Menu Rotation for Vertical Viewing (option)

1. Press the **MENU** button and then use ▲ / ▼ button to select the **SPECIAL** menu.
2. Press the ► button and then use ▲ / ▼ button to select **OSD Rotate**.
3. Press the ► button and then use the ▲ / ▼ button to select **Normal** or **Rotate**.
 - Select **Normal** : if the set is installed horizontally.
 - Select **Rotate** : if the set is installed vertically.
4. Repeatedly press the **MENU** button to return to normal viewing.

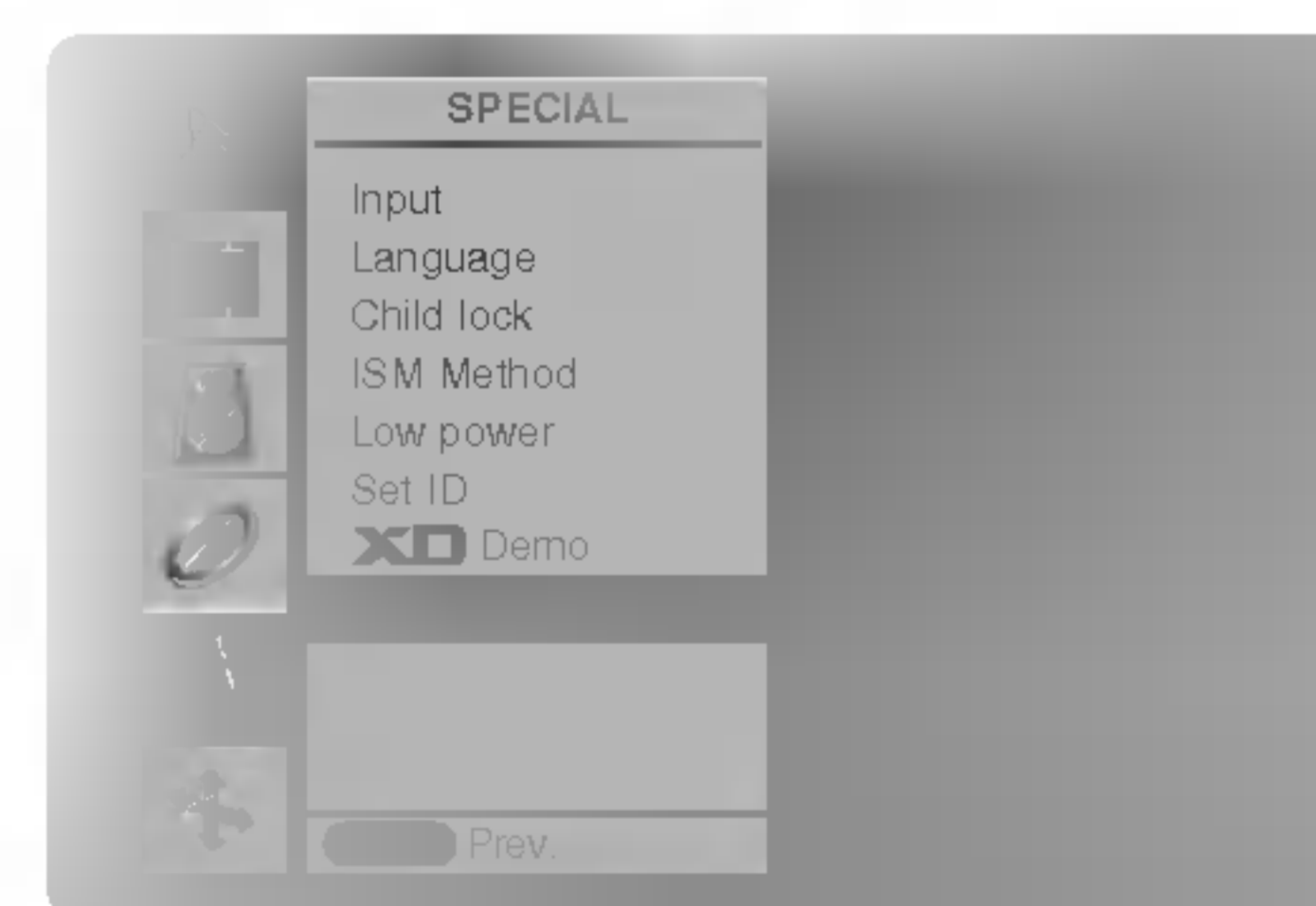

Screen Menu Options

Auto adjustment

- Automatically adjusts picture position and minimizes image shaking.
 - This function works in the following mode: RGB [PC] mode only
1. Press the **MENU** button and then use ▲ / ▼ button to select the SCREEN menu.
 2. Press the ► button and then use ▲ / ▼ button to select **Auto config.**
 3. Press the ► button to start **Auto config.**
 - When **Auto config.** has finished, **OK** will be shown on screen.
 - If the position of the image is still not correct, try Auto adjustment again.
 4. If picture needs to be adjusted more after Auto adjustment in RGB (PC), you can adjust the **Manual config.**
 5. Repeatedly press the **MENU** button to return to normal viewing.
- Although the image is still not correct, your set is functioning properly but needs further adjustment.
 - The **Auto config.** functions don't need to be run for HDMI mode.



Manual Configure

- If the picture isn't clear after auto adjustment and especially that characters are still trembling, adjust the picture phase manually.
 - To correct the screen size, adjust **Clock**.
 - This function works in the following mode:
RGB[PC], RGB[DTV], HDMI[DTV], COMPONENT[DTV] mode only
 - It's not available to use Phase, Clock function in RGB[DTV], HDMI[DTV], COMPONENT[DTV] mode.
1. Press the **MENU** button and then ▲ / ▼ button to select the SCREEN menu.
 2. Press the ► button and then ▲ / ▼ button to select **Manual config.**
 3. Press the ► button and then ▲ / ▼ button to select **Phase, Clock, H-Position** or **V-Position**.
 4. Press the ◀ / ▶ button to make appropriate adjustments.
 5. Repeatedly press the **MENU** button to return to normal viewing.



Selecting Wide VGA/XGA mode

- To see a normal picture, match the resolution of RGB mode and selection of VGA/XGA mode.
 - In some models, it's not available to selection of XGA mode.
 - This function works in the following mode: RGB[PC] mode only
1. Press the **MENU** button and then use ▲ / ▼ button to select the SCREEN menu.
 2. Press the ► button and then use ▲ / ▼ button to select **VGA Mode** (or **XGA Mode**).
 3. Press the ► button and then use ▲ / ▼ button to select the desired VGA/XGA resolution.
 4. Repeatedly press the **MENU** button to return to normal viewing.



Initializing (Reset to original factory value)

This function operates in current mode.
To initialize the adjusted value

1. Press the **MENU** button and then ▲ / ▼ button to select the SCREEN menu.
2. Press the ► button and then ▲ / ▼ button to select **Reset**.
3. Press the ► button.
 - You can initialize Phase, Clock, H-Position, V-Position, Position and Zoom +/-.



Setting Picture Format

- You can watch the screen in various picture formats; **Spectacle**, **Full** (option), **Original**, **4:3**, **16:9** (Wide), **14:9** and **Zoom**.

1. Press the **MENU** button and then use **▲ / ▼** button to select the **SCREEN** menu.
2. Press the **▶** button and then use **▲ / ▼** button to select **ARC**.
3. Press the **▶** button and then use **▲ / ▼** button to select **Spectacle**, **Full** (option), **Original**, **4:3**, **16:9**, **14:9** or **Zoom**.

• **Spectacle**

When your TV receives the wide screen signal, following selection will lead you to adjust the picture horizontally, in non-linear proportion, to fill the entire screen.

• **Full** (option)

When your TV receives the wide screen signal, following selection will lead you to adjust the picture horizontally or vertically, in a linear proportion, to fill the entire screen fully.

• **Original**

When your TV receives the wide screen signal, it will be automatically changed to the picture format to be sent.

• **4:3**

Following selection will lead you to view a picture with an original 4:3 aspect ratio, with gray bars appearing at both the left and right sides.

• **16:9** (Wide)

Following selection will lead you to adjust the picture horizontally, in a linear proportion, to fill the entire screen (useful for viewing 4:3 formatted DVDs).

• **14:9**

You can enjoy the picture format of 14:9 or general TV programme through the 14:9 mode. The screen 14:9 is viewed just like that the screen 4:3 is magnified to the left / right.

• **Zoom**

Following selection will lead you to view the picture without any alternation, while filling the entire screen. However, the top and bottom portions of the picture will be cropped.

4. Repeatedly press the **MENU** button to return to normal viewing.



- You can only select **4:3** and **16:9** (Wide) in RGB[PC], HDMI[PC] mode only.
- You can only select **4:3**, **16:9** (Wide) and **Zoom** in RGB[DTV], HDMI[DTV], Component [DTV] mode only.
- You can only select **Spectacle**, **Full**, **4:3**, **16:9** (Wide), **14:9** and **Zoom** in Component [480i/576i] mode only.
- There might be uncomfortable in full mode. Then change into other mode.

Picture Size Zoom

- When enlarging or reducing the picture, the screen may be display unnatural picture.

1. Press the **MENU** button and then **▲ / ▼** button to select the **SCREEN** menu.
2. Press the **▶** button and then **▲ / ▼** button to select **Zoom +/-**.
3. Press the **▶** button and then **◀ / ▶** button to make appropriate adjustments.
4. Repeatedly press the **MENU** button to return to normal viewing.



Screen Position

- You are available to this function after adjusting Zoom +/-.

1. Press the **MENU** button and then **▲ / ▼** button to select the **SCREEN** menu.
2. Press the **▶** button and then **▲ / ▼** button to select **Position**.
3. Press the **▶** button and then **▲ / ▼** or **◀ / ▶** button to adjust the position.
4. Repeatedly press the **MENU** button to return to normal viewing.

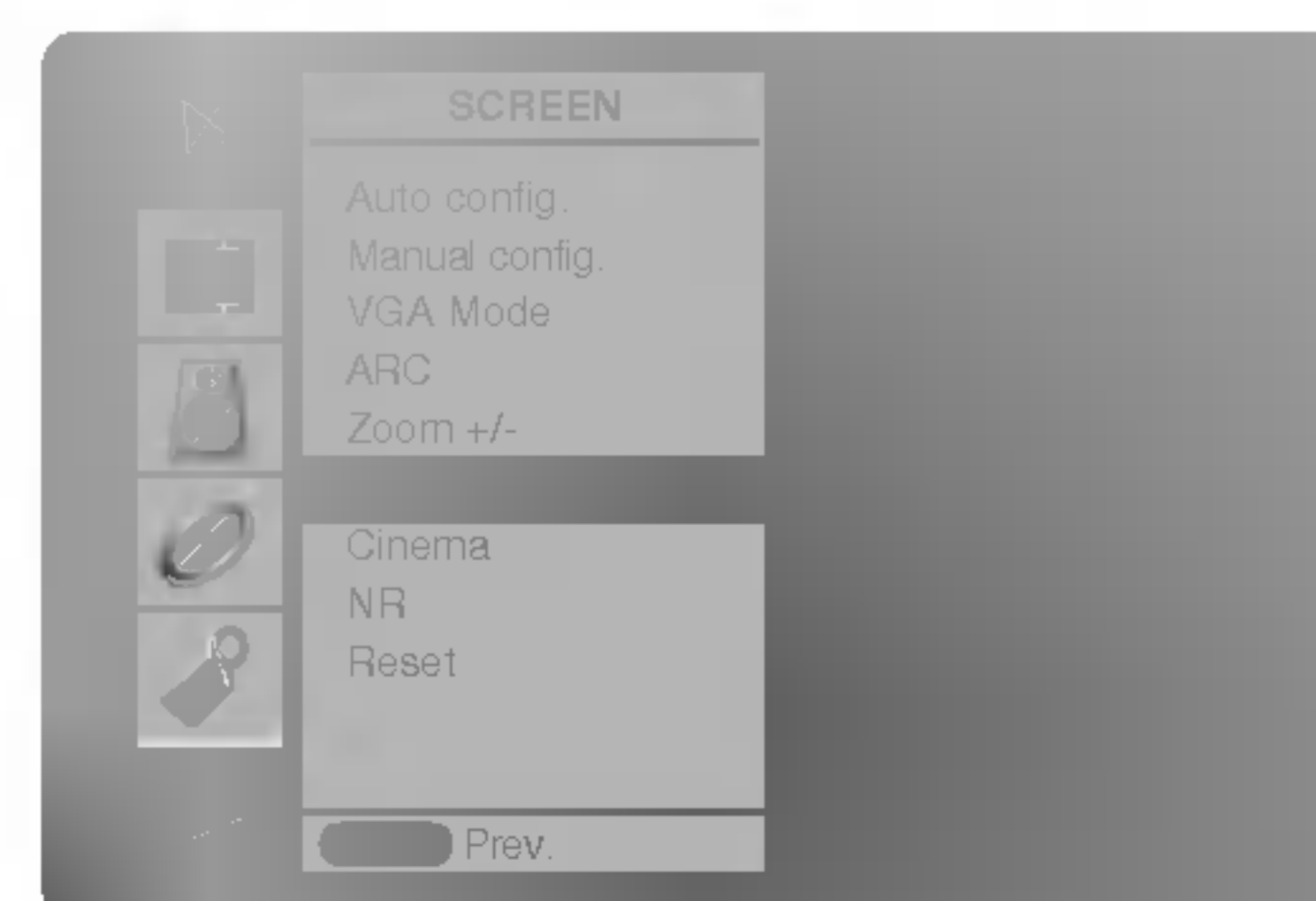

Screen Menu Options

Cinema

- When you watch the movie, this function adjusts the set to the best picture appearance.
- This function works in the following mode:
AV, S-VIDEO, COMPONENT 480i/576i.

1. Press the **MENU** button and then use ▲ / ▼ button to select the SCREEN menu.
2. Press the ► button and then use ▲ / ▼ button to select **Cinema**.
3. Press the ► button and then use ▲ / ▼ button to select **On** or **Off**.
4. Repeatedly press the **MENU** button to return to normal viewing.

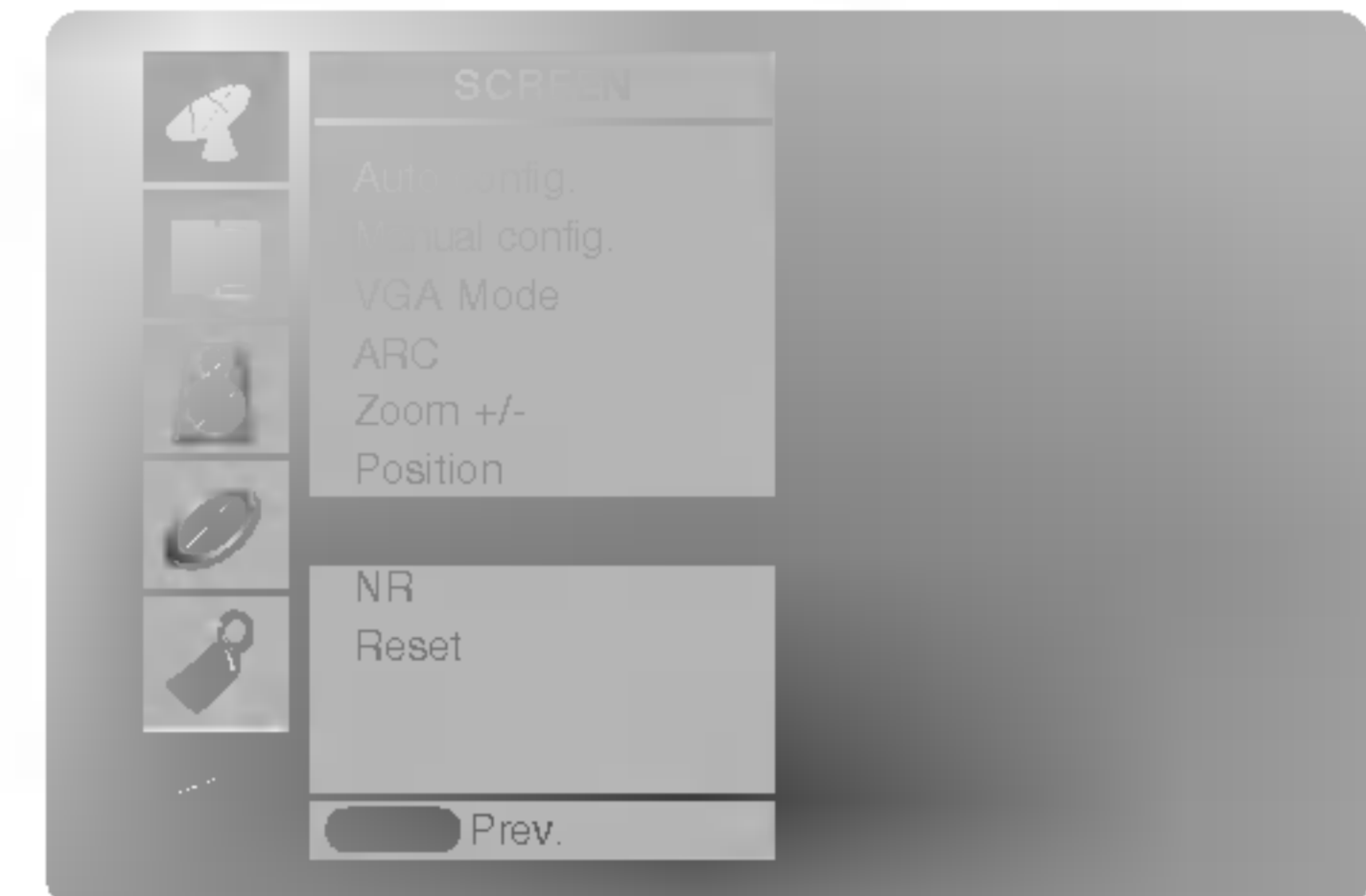

NR (Noise Reduction)

- You can select **3D NR** or **MPEG NR** to reduce the picture noise which may appear on the screen during watching the TV.
- This function is not available for use in RGB[PC], HDMI[PC] mode.
- **3D NR** is not available for use in RGB, HDMI, COMPONENT[DTV] mode.

1. Press the **MENU** button and then use ▲ / ▼ button to select the SCREEN menu.
2. Press the ► button and then use ▲ / ▼ button to select **NR**.
3. Press the ► button and then use ▲ / ▼ button to select **3D NR** or **MPEG NR**.
4. Repeatedly press the **MENU** button to return to normal viewing.



Split Zoom

- This is the function to enlarge the screen with regular ration.
- It's available to use this function in every input source.
- It's not available to use this function in **Rotate** mode.
- With 2-SPLIT ZOOM, you can only move the screen into upside or downside.
- If a screen is enlarged, a screen can move without selecting a section of screen.

1. Press the **SPLIT ZOOM** button.
 - Each press of **SPLIT ZOOM** button changes the screen display as shown below.

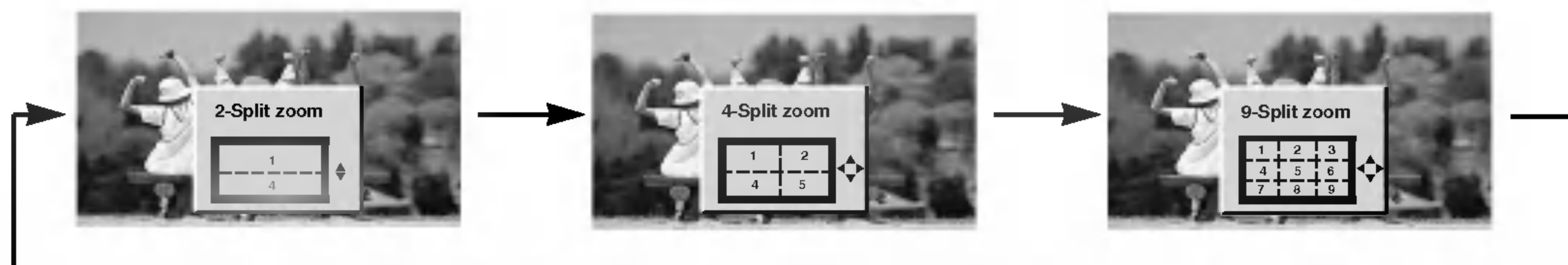

In case of 9-Split Zoom:

Press the number button to select the section you want to enlarge.
If you choose No.5, the 5 section is enlarged and also can move the enlarged screen with using the ▲ / ▼ or ◀ / ▶ button.

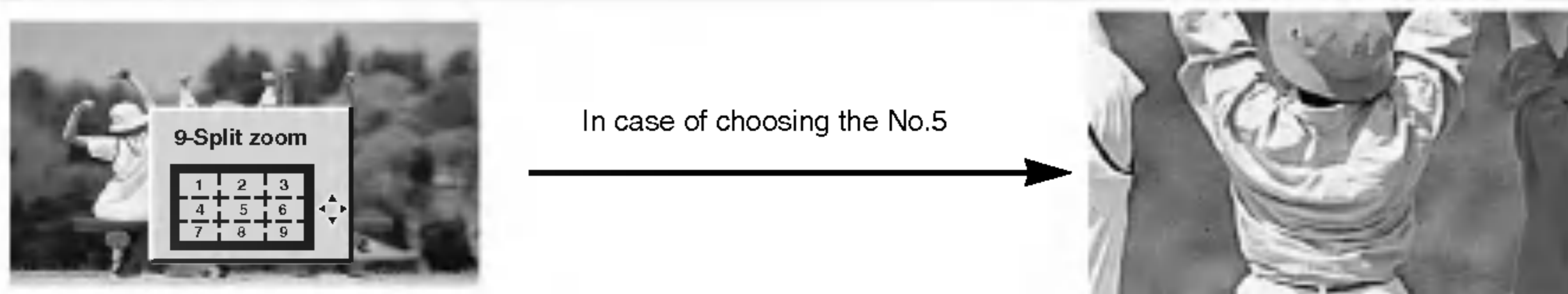

The 5 section is changed to a full screen.

External Control Device Setup

- Connect the RS-232C input jack to an external control device (such as a computer or an A/V control system) and control the set's functions externally.

How to connect external control equipment

- Connect the serial port of the control device to the RS-232C jack on the set back panel.
- RS-232C connection cables are not supplied with the set.
- The set remote control and front panel controls (except main power) will not be functional if the set is controlled by a PC computer or other external device.

Type of connector; D-Sub 9-pin male

No.	Pin name
1	No connection
2	RXD (Receive data)
3	TXD (Transmit data)
4	DTR (DTE side ready)
5	GND
6	DSR (DCE side ready)
7	RTS (Ready to send)
8	CTS (Clear to send)
9	No Connection

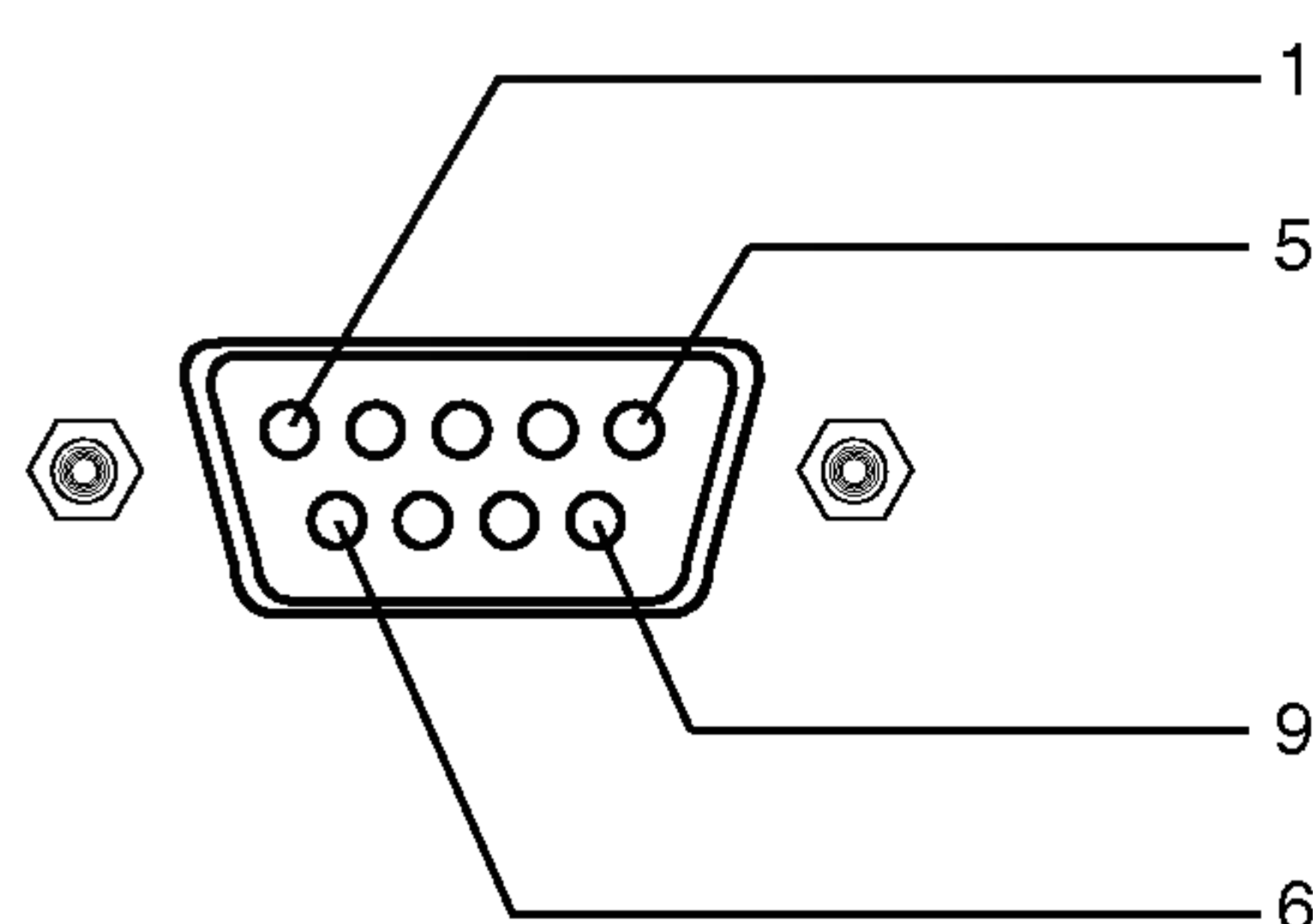

RS-232C configurations

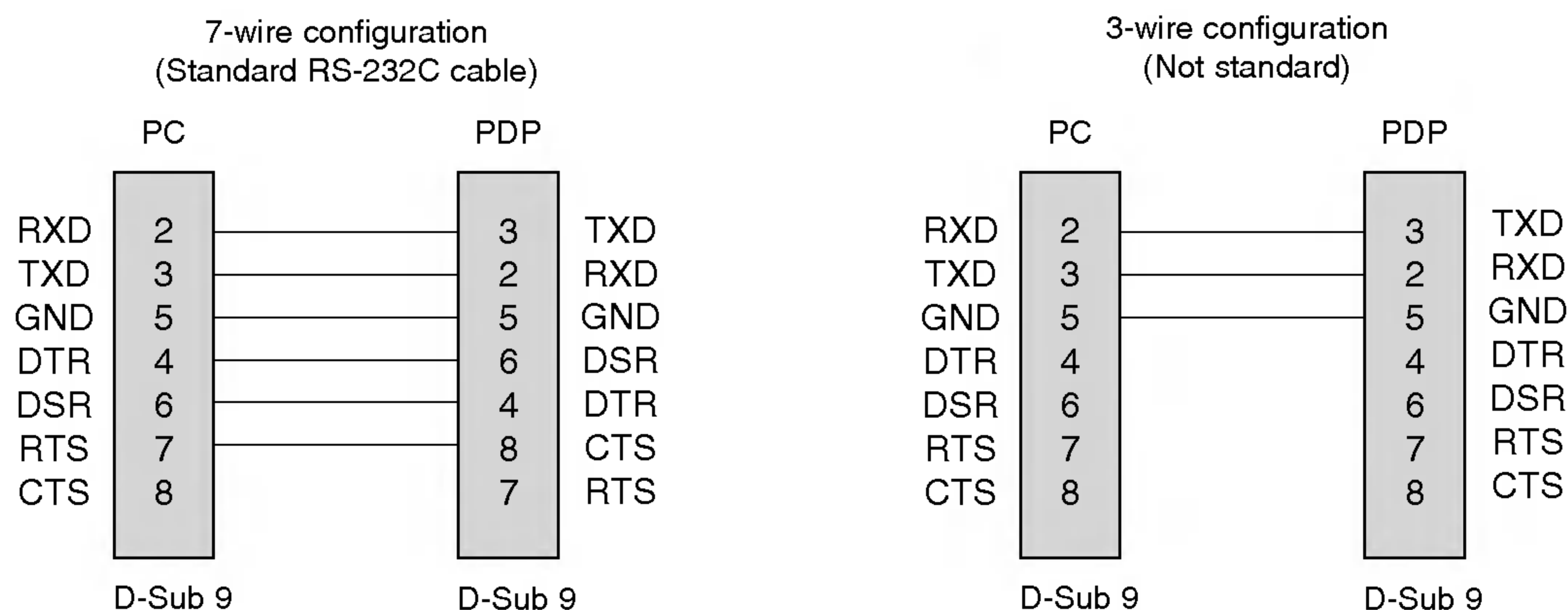

Set ID

- Use this function to specify a set ID number.
 - Refer to 'Real Data Mapping 1'. See page 34.
1. Press the **MENU** button and then use the ▲ / ▼ button to select the SPECIAL menu.
 2. Press the ► button and then use ▲ / ▼ button to select **Set ID**.
 3. Press the ► button and then use ◀ / ▶ button to adjust **Set ID** to choose the desired monitor ID number.
 - The adjustment range of **Set ID** is 1 ~ 99.
 4. Repeatedly press the **MENU** button to return to normal viewing.

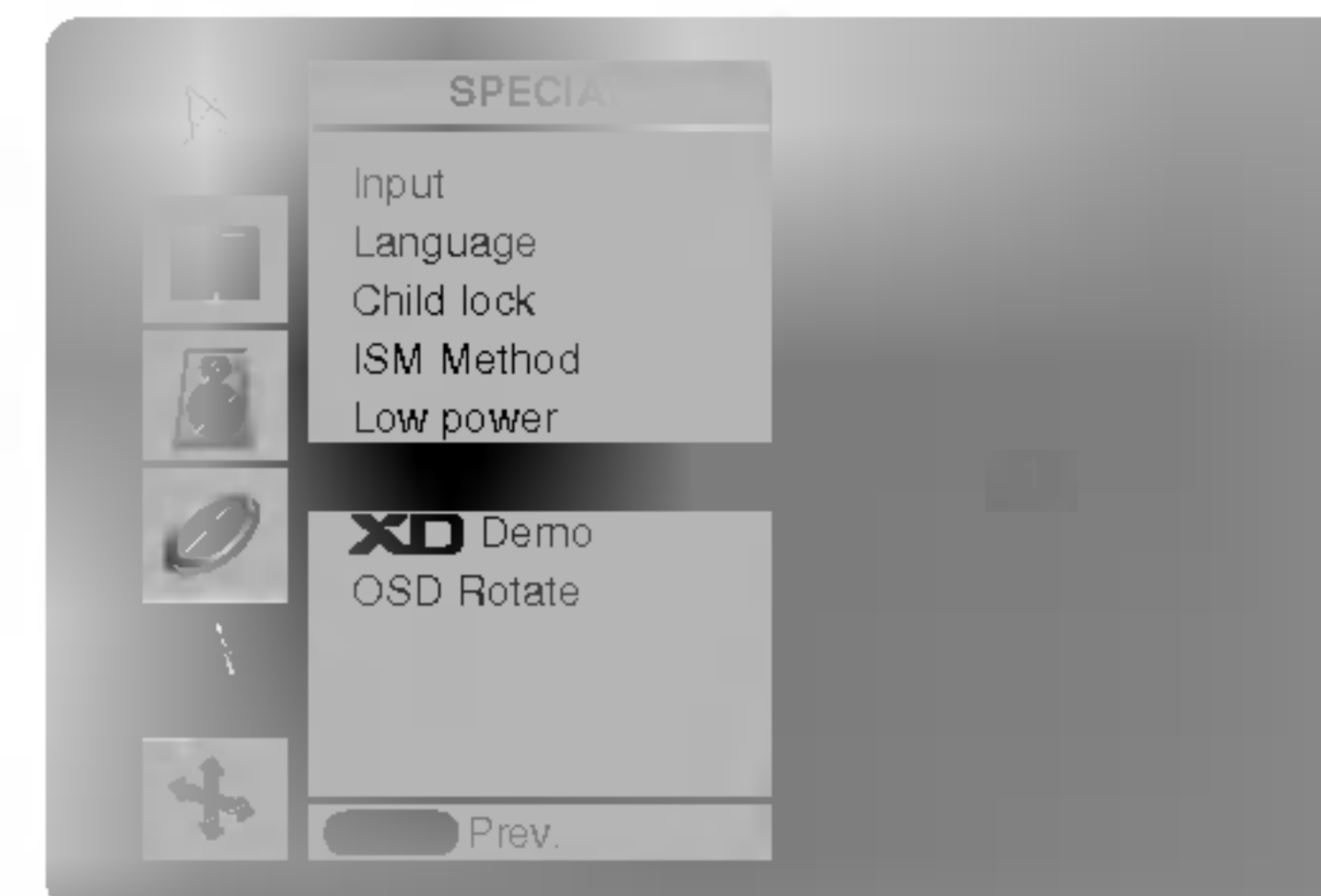

Communication Parameters

- Baud rate : 9600 bps (UART)
- Data length : 8 bits
- Parity : None
- * Use a crossed (reverse) cable.
- Stop bit : 1 bit
- Communication code : ASCII code

Command Reference List

	COMMAND 1	COMMAND 2	DATA (Hexadecimal)
01. Power	k	a	0 ~ 1
02. Input Select	k	b	Refer to p. 31
03. Aspect Ratio	k	c	Refer to p. 31
04. Screen Mute	k	d	0 ~ 1
05. Volume Mute	k	e	0 ~ 1
06. Volume Control	k	f	0 ~ 64
07. Contrast	k	g	0 ~ 64
08. Brightness	k	h	0 ~ 64
09. Colour	k	i	0 ~ 64
10. Tint	k	j	0 ~ 64
11. Sharpness	k	k	0 ~ 64
12. OSD Select	k	l	0 ~ 1
13. Remote control lock mode	k	m	0 ~ 1
14. Split Zoom	k	p	0 ~ 99
15. Treble	k	r	0 ~ 64
16. Bass	k	s	0 ~ 64
17. Balance	k	t	0 ~ 64
18. Colour Temperature (CSM)	k	u	0 ~ 3
19. Red Adjustment	k	v	0 ~ 50
20. Green Adjustment	k	w	0 ~ 50
21. Blue Adjustment	k	\$	0 ~ 50
22. Abnormal Status	k	z	0 ~ a
23. ISM Method	j	p	0 ~ 3
24. Low Power	j	q	0 ~ 1
25. Orbiter Time Setting	j	r	1 ~ FE
26. Orbiter Pixel Setting	j	s	1 ~ 3
27. Auto Configure	j	u	1
28. Send IR Code	m	c	Key code
29. Input select	x	b	Refer to p. 34

* When setting the 22 ~ 29, a menu doesn't display on screen.

Transmission / Receiving Protocol

Transmission

[Command1][Command2][][Set ID][][Data][Cr]

- * [Command 1] : First command to control PDP set. (j, k, m or x)
- * [Command 2] : Second command to control PDP set.
- * [Set ID] : You can adjust the set ID to choose desired monitor ID number in special menu. Adjustment range is 1 ~ 99. When selecting Set ID '0', every connected PDP set is controlled. Set ID is indicated as decimal (1~99) on menu and as Hexa decimal (0x0~0x63) on transmission/receiving protocol.
- * [DATA] : To transmit command data. Transmit 'FF' data to read status of command.
- * [Cr] : Carriage Return ASCII code '0x0D'
- * [] : ASCII code 'space (0x20)'

OK Acknowledgement

[Command2][][Set ID][][OK][Data][x]

- * The set transmits ACK (acknowledgement) based on this format when receiving normal data. At this time, if the data is data read mode, it indicates present status data. If the data is data write mode, it returns the data of the PC computer.

Error Acknowledgement

[Command2][][Set ID][][NG][Data][x]

- * The set transmits ACK (acknowledgement) based on this format when receiving abnormal data from non-viable functions or communication errors.

- Data 1: Illegal Code
- 2: not support function
- 3: Wait more time

01. Power (Command 2 : a)

- ▶ To control Power On/Off of the set.

Transmission

[k][a][][Set ID][][Data][Cr]

Data 0 : Power Off 1 : Power On

Ack

[a][][Set ID][][OK][Data][x]

- ▶ To show Power On/Off.

Transmission

[k][a][][Set ID][][FF][Cr]

Ack

[a][][Set ID][][OK][Data][x]

* In like manner, if other functions transmit '0xFF' data based on this format, Acknowledgement data feed back presents status about each function.

02. Input Select (Command 2 : b)

- ▶ To select input source for the set.
You can also select an input source using the INPUT button on the set's remote control.

Transmission

[k][b][][Set ID][][Data][Cr]

- RCA Type -

Data 0 : RGB	3 : Component2
1 : HDMI	4 : AV
2 : Component1	5 : S-Video

- Scart Type -

Data 0 : RGB	4 : AV2
1 : HDMI	5 : S-Video2
2 : Component	6 : AV3
3 : AV1	

Ack

[b][][Set ID][][OK][Data][x]

03. Aspect Ratio (Command 2 : c)

- ▶ To adjust the screen format. (Main picture format)
You can also adjust the screen format using the ARC (Aspect Ratio Control) button on remote control or in the SCREEN menu.

Transmission

[k][c][][Set ID][][Data][Cr]

Data 1 : Normal screen (4:3)	6 : Original
2 : Wide screen (16:9)	7 : Wide screen (14:9)
3 : Spectacle	8 : Full
4 : Full screen (Zoom)	

Ack

[c][][Set ID][][OK][Data][x]

* Using the PC input, you select either 16:9 or 4:3 screen aspect ratio.

04. Screen Mute (Command 2 : d)

- ▶ To select screen mute on/off.

Transmission

[k][d][][Set ID][][Data][Cr]

Data 0 : Screen mute off (Picture on)
1 : Screen mute on (Picture off)Ack

[d][][Set ID][][OK][Data][x]

05. Volume Mute (Command 2 : e)

- ▶ To control volume mute on/off.
You can also adjust mute using the MUTE button on remote control.

Transmission

[k][e][][Set ID][][Data][Cr]

Data 1 : Volume mute on (Volume off)
0 : Volume mute off (Volume on)Ack

[e][][Set ID][][OK][Data][x]

06. Volume Control (Command 2 : f)

- ▶ To adjust volume.
You can also adjust volume with the volume buttons on remote control.

Transmission

[k][f][][Set ID][][Data][Cr]

Data Min : 0 ~ Max : 64

* Refer to 'Real data mapping 1'. See page 34.

Ack

[f][][Set ID][][OK][Data][x]

07. Contrast (Command 2 : g)

- ▶ To adjust screen contrast.
You can also adjust contrast in the PICTURE menu.

Transmission

[k][g][][Set ID][][Data][Cr]

Data Min : 0 ~ Max : 64

* Refer to 'Real data mapping 1'. See page 34.

Ack

[g][][Set ID][][OK][Data][x]

08. Brightness (Command 2 : h)

- ▶ To adjust screen brightness.
You can also adjust brightness in the PICTURE menu.

Transmission

[k][h][][Set ID][][Data][Cr]

Data Min : 0 ~ Max : 64

* Refer to 'Real data mapping 1'. See page 34.

Ack

[h][][Set ID][][OK][Data][x]

09. Colour (Command 2 : i)

- ▶ To adjust the screen colour.
You can also adjust colour in the PICTURE menu.

Transmission

[k][i][][Set ID][][Data][Cr]

Data Min : 0 ~ Max : 64
* Refer to 'Real data mapping 1'. See page 34.

Ack

[i][][Set ID][][OK][Data][x]

10. Tint (Command 2 : j) (option)

- ▶ To adjust the screen tint.
You can also adjust tint in the PICTURE menu.

Transmission

[k][j][][Set ID][][Data][Cr]

Data Red : 0 ~ Green : 64
* Refer to 'Real data mapping 1'. See page 34.

Ack

[j][][Set ID][][OK][Data][x]

11. Sharpness (Command 2 : k)

- ▶ To adjust the screen sharpness.
You can also adjust sharpness in the PICTURE menu.

Transmission

[k][k][][Set ID][][Data][Cr]

Data Min : 0 ~ Max : 64
* Refer to 'Real data mapping 1'. See page 34.

Ack

[k][][Set ID][][OK][Data][x]

12. OSD Select (Command 2 : l)

- ▶ To select OSD (On Screen Display) on/off when controlling remotely.

Transmission

[k][l][][Set ID][][Data][Cr]

Data 0 : OSD off 1 : OSD on

Ack

[l][][Set ID][][OK][Data][x]

13. Remote control lock mode (Command 2 : m)

- ▶ To lock the front panel controls on the set and remote control.

Transmission

[k][m][][Set ID][][Data][Cr]

Data 0 : Lock off 1 : Lock on

Ack

[m][][Set ID][][OK][Data][x]

* If you're not using the remote control, use this mode.
When main power is on/off, external control lock is released.

14. Split Zoom (Command 2 : p)

- ▶ To operate split zoom function and select the split zoom section number.

Transmission

[k][p][][Set ID][][Data][Cr]

Data Min: 0 ~ Max: 99
ex. Data 21: Selection 1 of 2 split zoom.
• Refer to 'Real data mapping 2'.

Ack

[p][][Set ID][][OK][Data][x]

* **Real data mapping 2**

0 : Reset split zoom
21: Selection 1 of 2 split zoom
24: Selection 4 of 2 split zoom
41: Selection 1 of 4 split zoom
42: Selection 2 of 4 split zoom
44: Selection 4 of 4 split zoom
45: Selection 5 of 4 split zoom
91: Selection 1 of 9 split zoom
⋮
99: Selection 9 of 9 split zoom

15. Treble (Command 2 : r)

- ▶ To adjust treble.
You can also adjust treble in the SOUND menu.

Transmission

[k][r][][Set ID][][Data][Cr]

Data Min : 0 ~ Max : 64
* Refer to 'Real data mapping 1'. See page 34.

Ack

[r][][Set ID][][OK][Data][x]

16. Bass (Command 2 : s)

- ▶ To adjust bass.
You can also adjust bass in the SOUND menu.

Transmission

[k][s][][Set ID][][Data][Cr]

Data Min : 0 ~ Max : 64
* Refer to 'Real data mapping 1'. See page 34.

Ack

[s][][Set ID][][OK][Data][x]

17. Balance (Command 2 : t)

- ▶ To adjust balance.
You can also adjust balance in the SOUND menu.

Transmission

[k][t][][Set ID][][Data][Cr]

Data Min : 0 ~ Max : 64
* Refer to 'Real data mapping 1'. See page 34.

Ack

[t][][Set ID][][OK][Data][x]

18. Colour Temperature (Command 2 : u)

- ▶ To adjust colour temperature.
You can also adjust CSM in the PICTURE menu.

Transmission

```
[k][u][ ][Set ID][ ][Data][Cr]
```

Data 0: Cool 1: Normal 2: Warm 3: User

Ack

```
[u][ ][Set ID][ ][OK][Data][x]
```

19. Red Adjustment (Command 2 : v)

- ▶ To adjust red in colour temperature.

Transmission

```
[k][v][ ][Set ID][ ][Data][Cr]
```

Data Min : 0 ~ Max : 50

* Refer to 'Real data mapping 3'. See page 34.

Ack

```
[v][ ][Set ID][ ][OK][Data][x]
```

20. Green Adjustment (Command 2 : w)

- ▶ To adjust green in colour temperature.

Transmission

```
[k][w][ ][Set ID][ ][Data][Cr]
```

Data Min : 0 ~ Max : 50

* Refer to 'Real data mapping 3'. See page 34.

Ack

```
[w][ ][Set ID][ ][OK][Data][x]
```

21. Blue Adjustment (Command 2 : \$)

- ▶ To adjust blue in colour temperature.

Transmission

```
[k][$][ ][Set ID][ ][Data][Cr]
```

Data Min : 0 ~ Max : 50

* Refer to 'Real data mapping 3'. See page 34.

Ack

```
[$][ ][Set ID][ ][OK][Data][x]
```

22. Abnormal State (Command 2 : z)

- ▶ To recognize an abnormal state.

Transmission

```
[k][z][ ][Set ID][ ][FF][ ][Cr]
```

Data FF : Read

Ack

```
[z][ ][Set ID][ ][OK][Data][x]
```

Data 0: Normal (Power on and signal exist)
1: No signal (Power on)
2: Turn the set off by remote control
3: Turn the set off by sleep time function
4: Turn the set off by RS-232C function
5: 5V down
6: AC down
7: Turn the set off by Fan Alarm function
8: Turn the set off by Off time function
9: Turn the set off by Auto sleep function
a: Turn the set off by AV board detect

* This function is "read only".

**23. ISM Method
(Command 1 : j, Command 2 : p)**

- ▶ To control the ISM method. You can also adjust ISM Method in SPECIAL menu.

Transmission

```
[j][p][ ][Set ID][ ][Data][Cr]
```

Data 0 : Normal Mode 2 : Orbiter
1 : White Wash 3 : Inversion

Ack

```
[p][ ][Set ID][ ][OK][Data][x]
```

**24. Low Power
(Command 1 : j, Command 2 : q)**

- ▶ To reduce the power consumption of the set. You can also adjust Low Power in SPECIAL menu.

Transmission

```
[j][q][ ][Set ID][ ][Data][ ][Cr]
```

Data 0 : Off
1 : On

Ack

```
[q][ ][Set ID][ ][OK][Data][x]
```

**25. Orbiter Time Setting
(Command 1 : j, Command 2 : r)**

- ▶ To adjust orbiter operation time term.

Transmission

```
[j][r][ ][Set ID][ ][Data][ ][Cr]
```

Data Min: 1 ~ Max: FE

* Refer to 'Real data mapping 1'.

Ack

```
[r][ ][Set ID][ ][OK][Data][x]
```

26. Orbiter Pixel Setting
(Command 1 : j, Command 2 : s)

► To adjust pixel number in orbiter function.

Transmission

[j][s][][Set ID][][Data][Cr]

Data Min: 1 ~ Max: 3
* Refer to 'Real data mapping 1'.

Ack

[s][][Set ID][][OK][Data][x]

27. Auto Configure
(Command 1 : j, Command 2 : u)

► To adjust picture position and minimize image shaking automatically. It works only in RGB (PC) mode.

Transmission

[j][u][][Set ID][][Data][Cr]

Data 1: To set

Ack

[u][][Set ID][][OK][Data][x]

28. Send IR Code
(Command 1 : m, Command 2 : c)

► To send IR remote key code.

Transmission

[m][c][][Set ID][][Data][Cr]

Data Key code - Refer to page 36~37.

Ack

[c][][Set ID][][OK][Data][x]

* Real data mapping 1

0	: Step 0
⋮	
A	: Step 10 (Set ID 10)
⋮	
F	: Step 15 (Set ID 15)
10	: Step 16 (Set ID 16)
⋮	
64	: Step 100
⋮	
6E	: Step 110
⋮	
73	: Step 115
74	: Step 116
⋮	
C7	: Step 199
⋮	
FE	: Step 254
FF	: Step 255

* Real data mapping 3

0	: -40
1	: -39
2	: -38
⋮	
28	: 0
⋮	
4E	: +38
4F	: +39
50	: +40

29. Input select (Command 1 : x, Command 2 : b)

► To select input source for the set.

Transmission

[x][b][][Set ID][][Data][Cr]

Data Structure

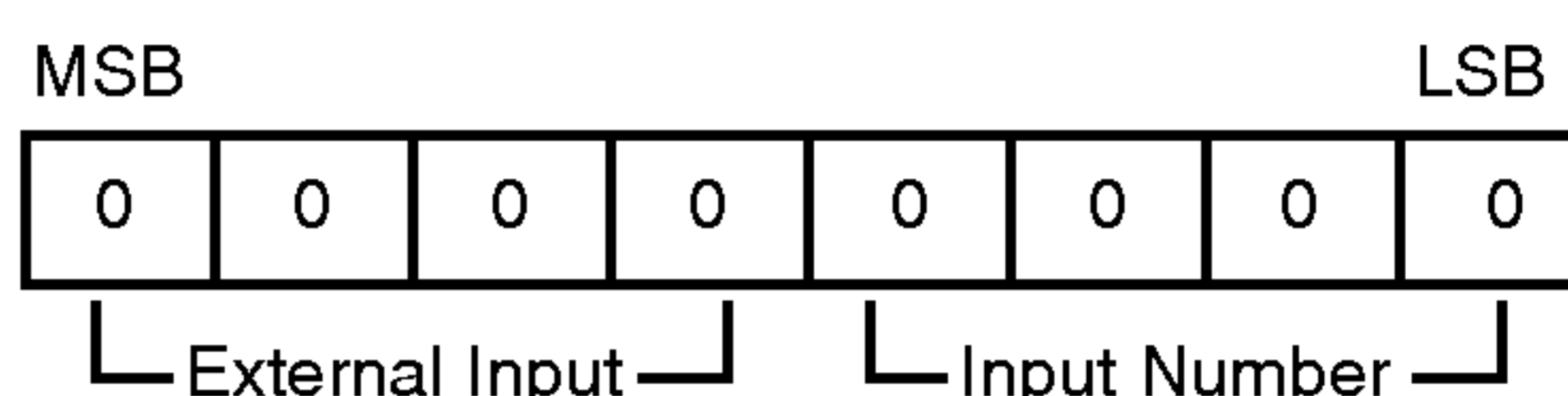

External Input				Data
0	0	0	1	Analog
0	0	1	0	AV
0	1	0	0	Component
0	1	0	1	RGB-DTV
0	1	1	0	RGB-PC
1	0	0	1	HDMI

- RCA Type -

Input Number				Data
0	0	0	0	Input1
0	0	0	1	Input2

- Scart Type -

Input Number				Data
0	0	0	0	Input1
0	0	0	1	Input2
0	0	1	0	Input3
0	0	1	1	Input4

Ack

[b][][Set ID][][OK][Data][x]

IR Code (NEC Format)

How to connect

- ▶ Connect your wired remote control to the Remote Control port on the set.

Remote Control IR Code (NEC Format)

▶ Output waveform

Single pulse, modulated with 37.917KHz signal at 455KHz

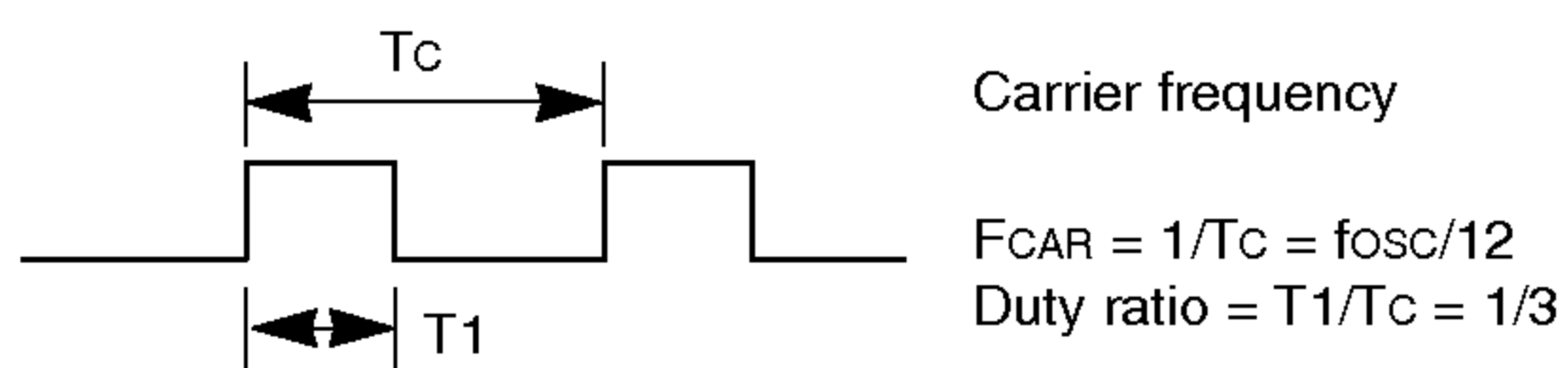

▶ Configuration of frame

- 1st frame

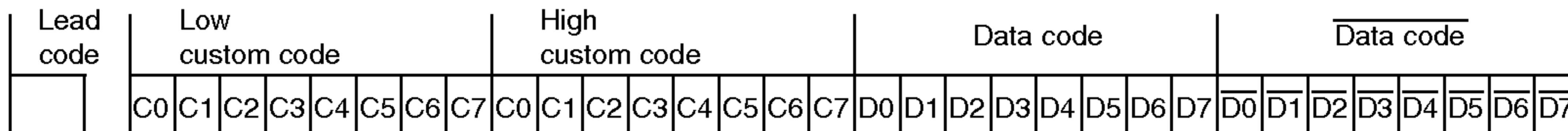

- Repeat frame

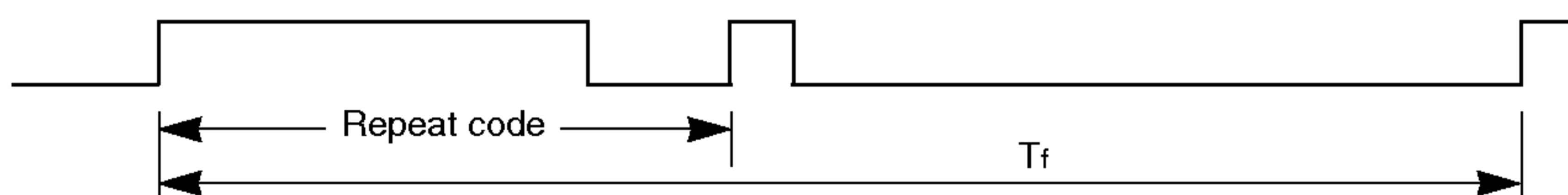

▶ Lead code

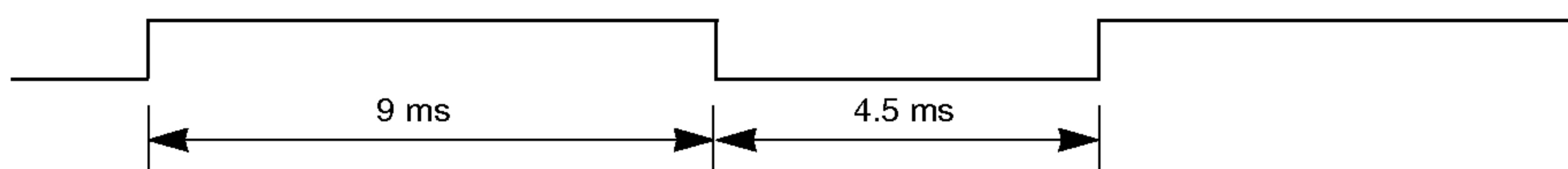

▶ Repeat code

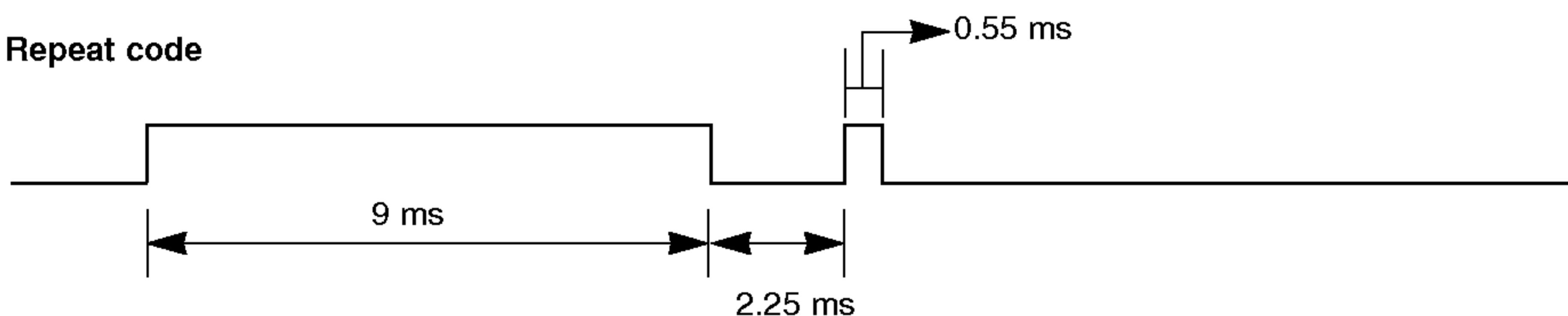

▶ Bit description

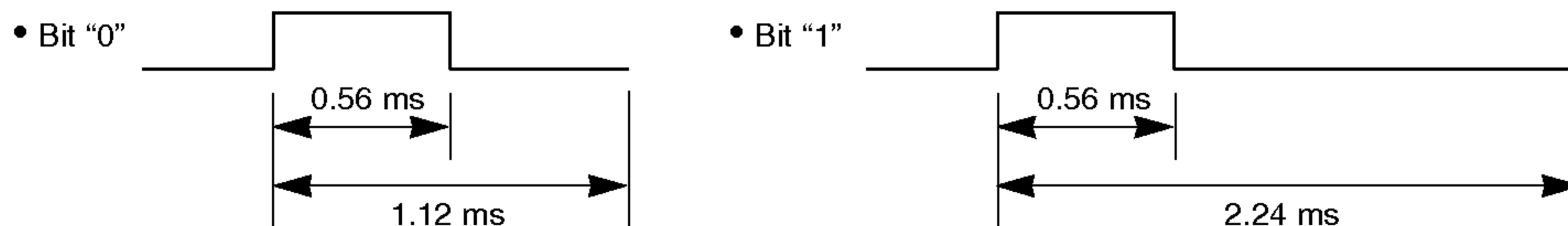

▶ Frame interval : Tf

The waveform is transmitted as long as a key is depressed.

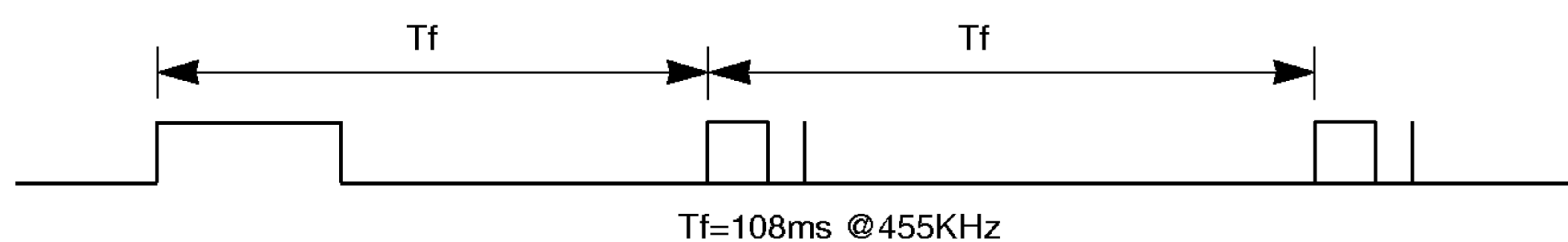

- RCA Type -

Code (Hexa)	Function	Note
00	UP (▲)	R/C Button
01	DOWN (▼)	R/C Button
02	VOL (▶)	R/C Button
03	VOL (◀)	R/C Button
08	POWER	R/C Button (Power On/Off)
C4	POWER ON	Discrete IR Code (Only Power On)
C5	POWER OFF	Discrete IR Code (Only Power Off)
09	MUTE	R/C Button
10	Number Key 0	R/C Button
11	Number Key 1	R/C Button
12	Number Key 2	R/C Button
13	Number Key 3	R/C Button
14	Number Key 4	R/C Button
15	Number Key 5	R/C Button
16	Number Key 6	R/C Button
17	Number Key 7	R/C Button
18	Number Key 8	R/C Button
19	Number Key 9	R/C Button
0B	INPUT	R/C Button
98	MULTIMEDIA	R/C Button
BF	COMPONENT1	Discrete IR Code (Input COMPONENT1 Selection)
D4	COMPONENT2	Discrete IR Code (Input COMPONENT2 Selection)
C6	HDMI	Discrete IR Code (Input HDMI Selection)
D5	RGB	Discrete IR Code (Input RGB Selection)
5A	AV	Discrete IR Code (Input AV Selection)
D8	S-Video	Discrete IR Code (Input S-Video Selection)
0A	I/II	R/C Button
0E	SLEEP	R/C Button
43	MENU	R/C Button
44	OK(●)	R/C Button
4D	PSM	R/C Button
52	SSM	R/C Button
53	LIST	R/C Button
20	TEXT/★	R/C Button
2A	REVEAL	R/C Button
22	MODE	R/C Button
24	MIX	R/C Button
26	TIME	R/C Button
62	UPDATE	R/C Button
64	SIZE	R/C Button
65	HOLD	R/C Button
70	INDEX	R/C Button
79	ARC	R/C Button
76	ARC (4:3)	Discrete IR Code (Only 4:3 mode)
77	ARC (16:9)	Discrete IR Code (Only 16:9 mode)
AF	ARC (Zoom)	Discrete IR Code (Only Zoom mode)

- Scart Type -

Code (Hexa)	Function	Note
00	UP (▲)	R/C Button
01	DOWN (▼)	R/C Button
02	VOL (▶)	R/C Button
03	VOL (◀)	R/C Button
08	POWER	R/C Button (Power On/Off)
C4	POWER ON	Discrete IR Code (Only Power On)
C5	POWER OFF	Discrete IR Code (Only Power Off)
09	MUTE	R/C Button
10	Number Key 0	R/C Button
11	Number Key 1	R/C Button
12	Number Key 2	R/C Button
13	Number Key 3	R/C Button
14	Number Key 4	R/C Button
15	Number Key 5	R/C Button
16	Number Key 6	R/C Button
17	Number Key 7	R/C Button
18	Number Key 8	R/C Button
19	Number Key 9	R/C Button
0B	INPUT	R/C Button
98	MULTIMEDIA	R/C Button
BF	COMPONENT	Discrete IR Code (Input COMPONENT Selection)
C6	HDMI	Discrete IR Code (Input HDMI Selection)
D5	RGB	Discrete IR Code (Input RGB Selection)
5A	AV1	Discrete IR Code (Input AV1 Selection)
D0	AV2	Discrete IR Code (Input AV2 Selection)
D1	AV3	Discrete IR Code (Input AV3 Selection)
D3	S-Video2	Discrete IR Code (Input S-Video2 Selection)
0A	I/II	R/C Button
0E	SLEEP	R/C Button
43	MENU	R/C Button
44	OK(●)	R/C Button
4D	PSM	R/C Button
52	SSM	R/C Button
53	LIST	R/C Button
20	TEXT/★	R/C Button
2A	REVEAL	R/C Button
22	MODE	R/C Button
24	MIX	R/C Button
26	TIME	R/C Button
62	UPDATE	R/C Button
64	SIZE	R/C Button
65	HOLD	R/C Button
70	INDEX	R/C Button
79	ARC	R/C Button
76	ARC (4:3)	Discrete IR Code (Only 4:3 mode)
77	ARC (16:9)	Discrete IR Code (Only 16:9 mode)
AF	ARC (Zoom)	Discrete IR Code (Only Zoom mode)

Troubleshooting Checklist

No picture & No sound	<ul style="list-style-type: none">• Check whether the set is turned on.• Power cord inserted into wall outlet?• Plug another product's power cord into the wall outlet where the set's power cord was plugged in.
Picture OK & No sound	<ul style="list-style-type: none">• Press the VOLUME (▶) button.• Sound muted? Press MUTE button. <p>Check whether the Speaker is "On" in the SOUND menu. (Refer to p. 22)</p>
The remote control doesn't work	<ul style="list-style-type: none">• Check to see if there is any object between the set and the remote control causing obstruction.• Check to see if the batteries are installed with the correct polarities. (Refer to p.6)• Check if the remote control handset is set up to correct mode.• Install new batteries. (Refer to p.6)
Picture appears slowly, after switching on	<ul style="list-style-type: none">• This is normal as the image is muted during the startup process of the set. Please contact your service centre, if the picture has not appeared after five minutes.
No or Poor colour or Poor picture	<ul style="list-style-type: none">• Select Colour in the PICTURE menu and press the VOLUME (▶) button. (Refer to p.20)• Keep a certain distance between the set and the VCR.• Activate any function to restore the brightness of the picture. (If still picture is on the screen for more than 5 minutes, the screen gets dark.)
Horizontal/vertical bars or picture shaking	<ul style="list-style-type: none">• Check for local interference such as an electrical appliance or power tool.
No output from one of the speakers	<ul style="list-style-type: none">• Adjust Balance in the SOUND menu. (Refer to p.22)
Unusual sound from inside the set	<ul style="list-style-type: none">• A change in ambient humidity or temperature may result in an unusual noise at the time of switching off or on of the set and does not indicate a fault with the set.

Product Specifications

MODEL	42PM1M 42PM1M-TA 42PM1M-ZA	42PM1MH 42PM1MH-TA	50PM1M 50PM1M-TA 50PM1M-ZA	50PM1MH 50PM1MH-TA
Width (inches / mm)	42 / 1066		49.3 / 1253	
Height (inches / mm)	25.6 / 650		29.3 / 745	
Depth (inches / mm)	3.9 / 97.5		4 / 99.5	
Weight (pounds / kg)	66 / 30		90.4 / 41	
Power requirement	AC100-240V, 50/60Hz			
Operating Temperature Range	32 ~ 104°F (0 ~ 40°C)			
Operating Humidity Range	Less than 80%			

MODEL	60PZ9M 60PZ9M-TA 60PZ9M-ZA	60PZ9MH 60PZ9MH-TA	42PM3MV 42PM3MV-TA 42PM3MV-ZA	42PM3MVH 42PM3MVH-TA
Width (inches / mm)	56.9 / 1455		41.4 / 1050	
Height (inches / mm)	34.8 / 883		24.8 / 630	
Depth (inches / mm)	4.5 / 112		3.6 / 91.5	
Weight (pounds / kg)	138.9 / 63		64 / 29	
Power requirement	AC100-240V, 50/60Hz			
Operating Temperature Range	32 ~ 104°F (0 ~ 40°C)			
Operating Humidity Range	Less than 80%			

- The specifications shown above may be changed without notice for quality improvement.

