



Room Air Conditioner OWNER'S MANUAL

Please read carefully and thoroughly this manual before operating this unit.



Safety Precautions

- Warning2
- Caution3

Operating Instructions

- Preparation before operation.. 4
- Remote Control Features..... 5
- Operation Mode Selection..... 7
- Additional Features.....13

Care and Maintenance

- Care and Maintenance.....16
- Operation Tips.....18

Troubleshooting tips

- Before You
Call For Service..... 19

Safety precautions

To prevent injury to the user or other people and property damage, the following instructions must be followed.

■ Incorrect operation due to ignoring of instruction will cause harm or damage. the seriousness is classified by the following indications.

● WARNING ●

This symbol indicates the possibility of death or serious injury.

● CAUTION ●

This symbol indicates the possibility of injury or damage to properties only.

● WARNING ●

■ **Do not install, remove or disassemble the unit by yourself.**

- Improper installation will cause water leakage, electrical shock, or fire. Please consult authorized dealer or specialist for the installation work. Please note that fault caused by improper installation is not covered by warranty.
- Unit must be installed in an easily accessible area. Any additional cost required to hire a special equipment to service the unit will be the responsibility of the customer.

● WARNING ●

Plug in the power plug

- Otherwise, it will cause electrical shock or fire due to heat generation.

Do not operate or store the unit with the power plug inserted.

- It will cause electrical shock or fire due to heat generation.

Do not damage or use an extension cord.

- It will cause electrical shock or fire.
- If the supply cord is damaged, it must be replaced by the manufacturer or its service agent or a similarly qualified person in order to avoid a hazard.

Do not modify power cord

- It will cause electrical shock or fire due to heat generation.

Do not operate in wet

- It may cause electrical shock.

Do not insert anything into the fan.

- Since the fan rotates at high speed, this may cause an injury or damage the unit.

Do not expose the unit to rain or moisture.

- This could damage our health.

When an abnormality (smell of burning, etc) occurs, stop the unit.

- If the unit continues to be operated in an abnormal condition, it may cause a fire, damage, etc. In this case, consult your dealer.

Repair or relocation should be done by a qualified technician.

- If this is done incorrectly, it may cause a fire, electric shock, injury by dropping of the unit, water leakage, etc. Consult your dealer.

CAUTION

- Contact the authorized service technician or repair person for maintenance of this unit.
- Contact the installer for installation of this unit.
- The air conditioner is not intended for use by young children or infirm persons without supervision.
- Young children should be supervised to ensure that they do not play with the air conditioner.

CAUTION



- It may cause an injury.
- Should be disconnected from supply



- Water may enter the unit and degrade the insulation. It may cause an electric shock.



- An oxygen shortage may occur.



- Since the fan rotates at high speed during operation, it may cause an injury.



- This could injure the pet or plant.



- The unit may drop or fall down and cause an injury.



- It may cause a fire or deformation of the cabinet.



- It may affect combustion.



- It may cause an injury through dropping or falling down.



- It will cause an injury by the rotating blower.



- If not, dirt may collect and cause a fire.



- It may cause an injury, etc. by falling down.



- Do not use this air conditioner to preserve precision devices, food, animal, plants, and art objects. It may cause deterioration of quality, etc.



- In the cooling mode, if it is operated in a room with high humidity (80% RH or more) for a long time, water condensed in the air conditioner may drop and may wet and spoil furniture, etc.

Preparation before operation

How to Insert the Batteries

- 1 Remove the battery cover by pulling it according to the arrow direction.
- 2 Insert new batteries making sure that the (+) and (-) of battery are installed correctly.
- 3 Reattach the cover by sliding it back into position.

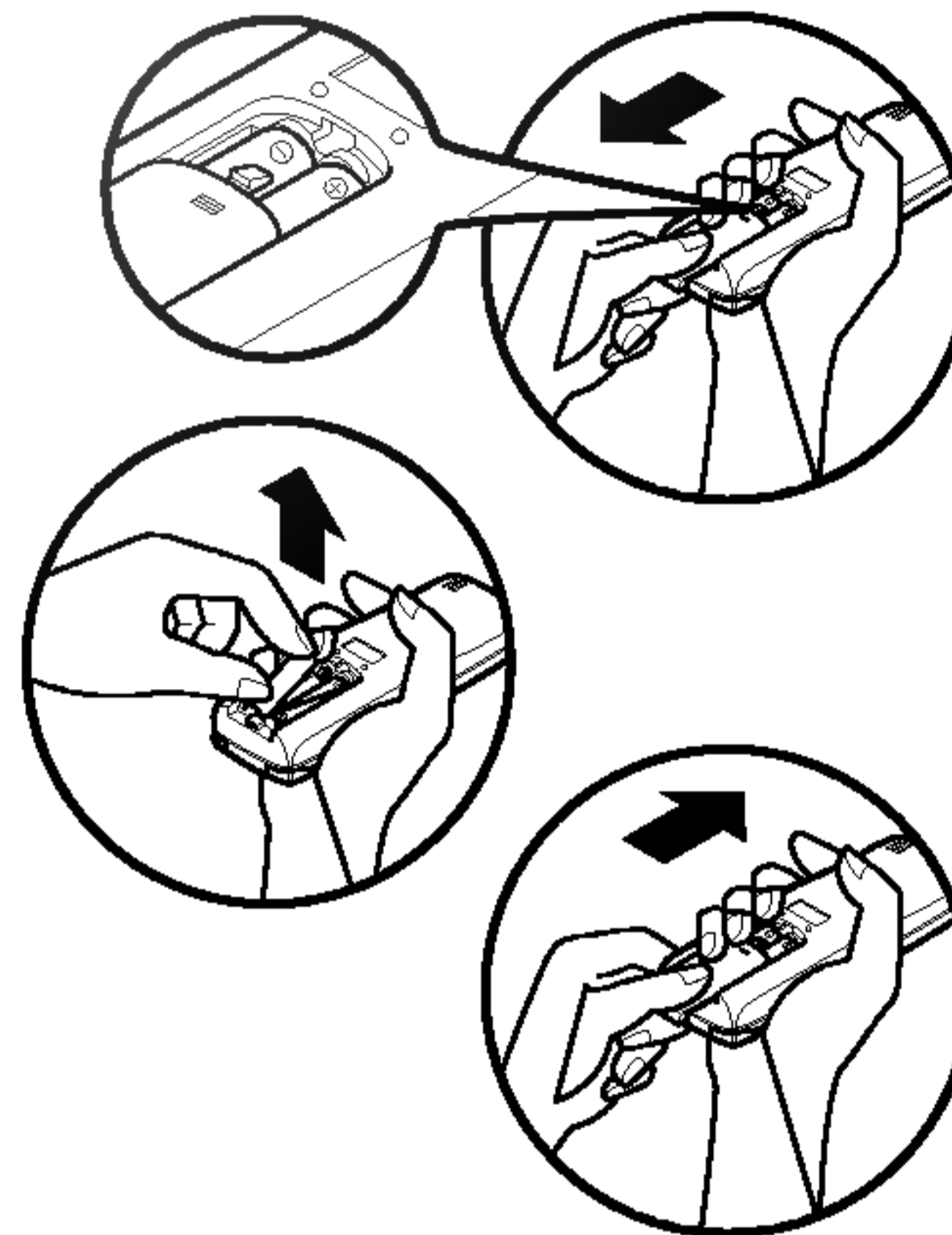

NOTES:

- Use 2 AAA(1.5volt) batteries. Do not use rechargeable batteries.

Storage and Tips For Using the Remote Control

- The remote control may be stored by mounting it on a wall.
- To operate the room air conditioner, aim the remote control at the signal receptor.

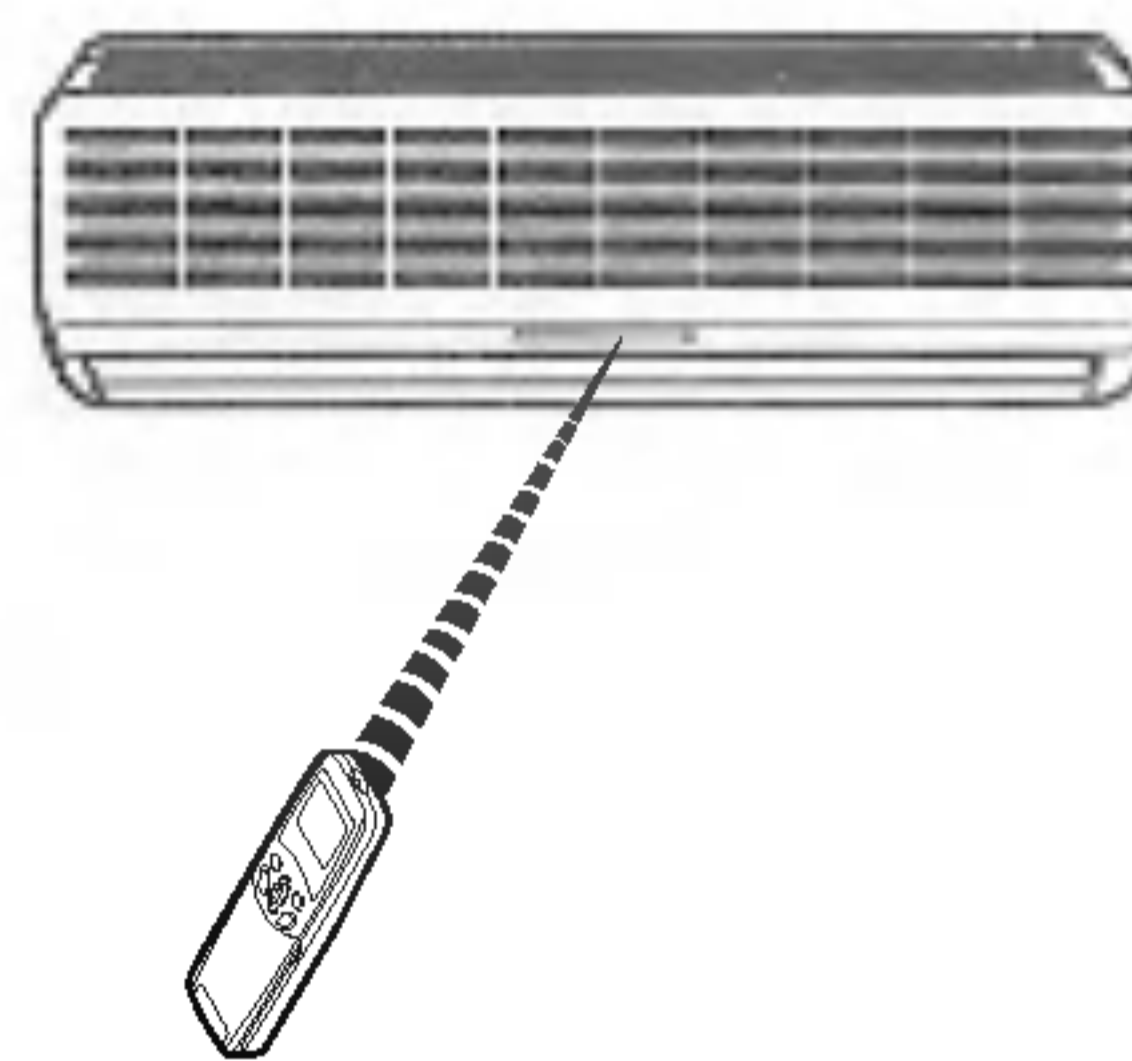
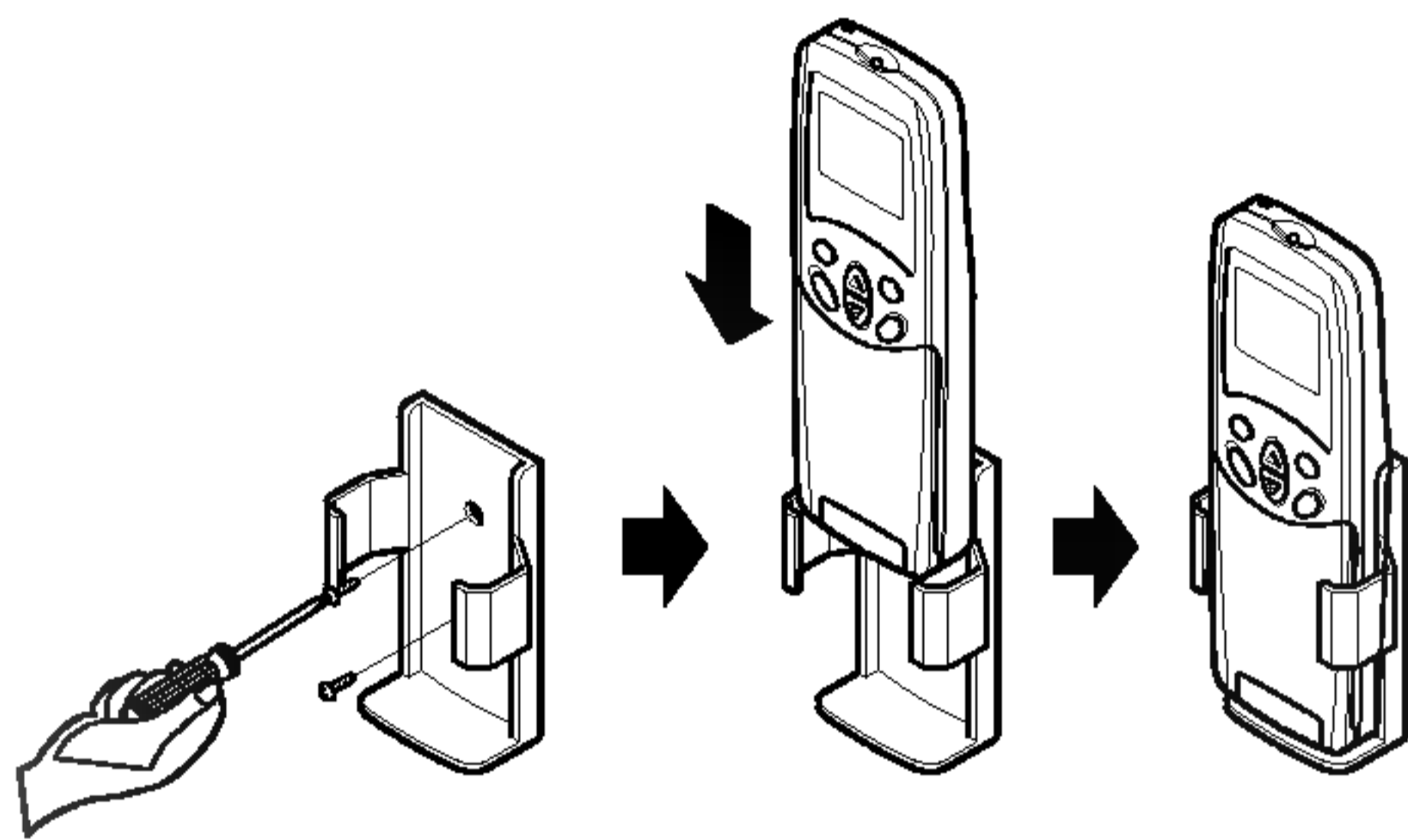

Signal Receptor

Receives the signals from the remote control.(Signal receiving sound: two short beeps or one long beep.)

Operation Indication Lamps

- ⓘ On/Off : Lights up during the system operation.
- ★ Sleep Mode : Lights up during Sleep Mode Auto operation.
- 🕒 Timer : Lights up during Timer operation.
- *🔻 Defrost Mode : Lights up during Defrost Mode or Hot Start operation (Heat pump model only)
- OUT DOOR** OUTDOOR UNIT OPERATION : Lights up during outdoor unit operation. (Cooling model only)

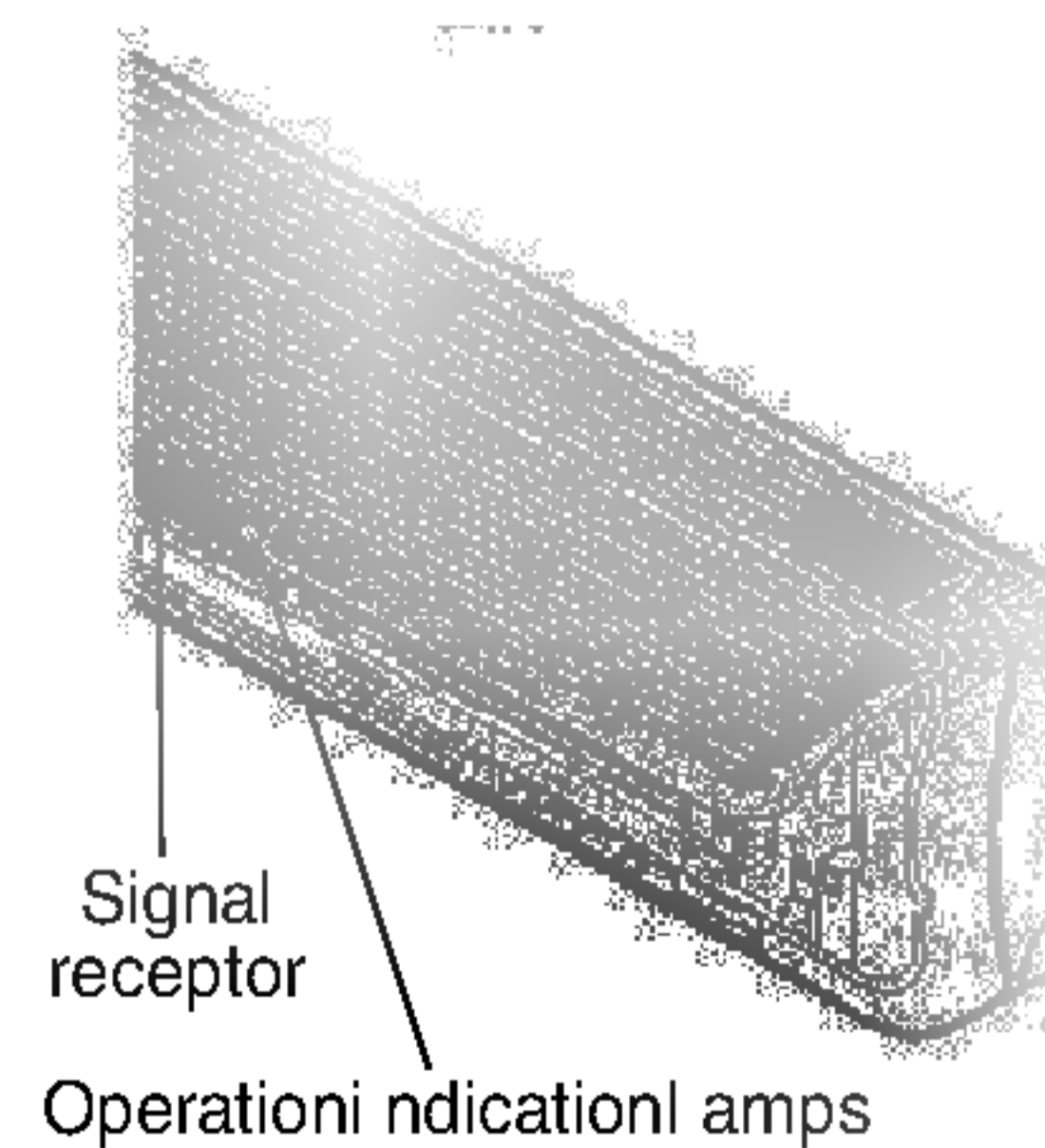





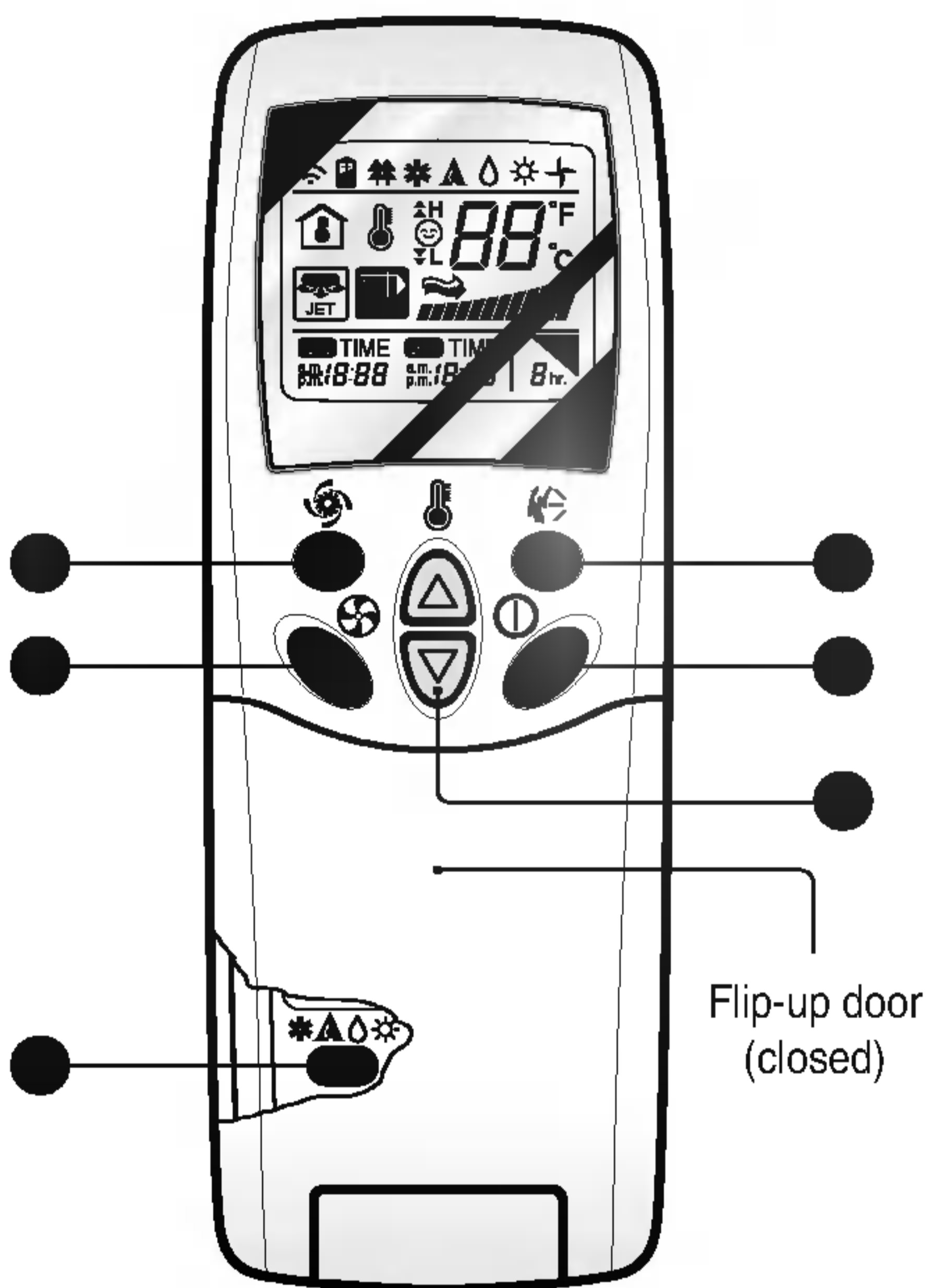

About the remote control on the system

The remote control transmits the signals to the system.



Features of the Remote Control- Door Closed



- 
START/STOP BUTTON
 Operation starts when this button is pressed and stops when the button is pressed again.
- 
OPERATION MODE SELECTION BUTTON
 Used to select the operation mode.
- 
ROOM TEMPERATURE SETTING BUTTONS
 Used to select the room temperature.
- 
INDOOR FAN SPEED SELECTOR
 Used to select fan speed in four steps low, medium, high, or CHAOS.
- 
JET COOL
 Used to start or stop the speed cooling. (Speed cooling operates super high fan speed in cooling mode).
- 
CHAOS SWING BUTTON
 Used to stop or start louver movement and set the desired up/down airflow direction.

Operation Mode

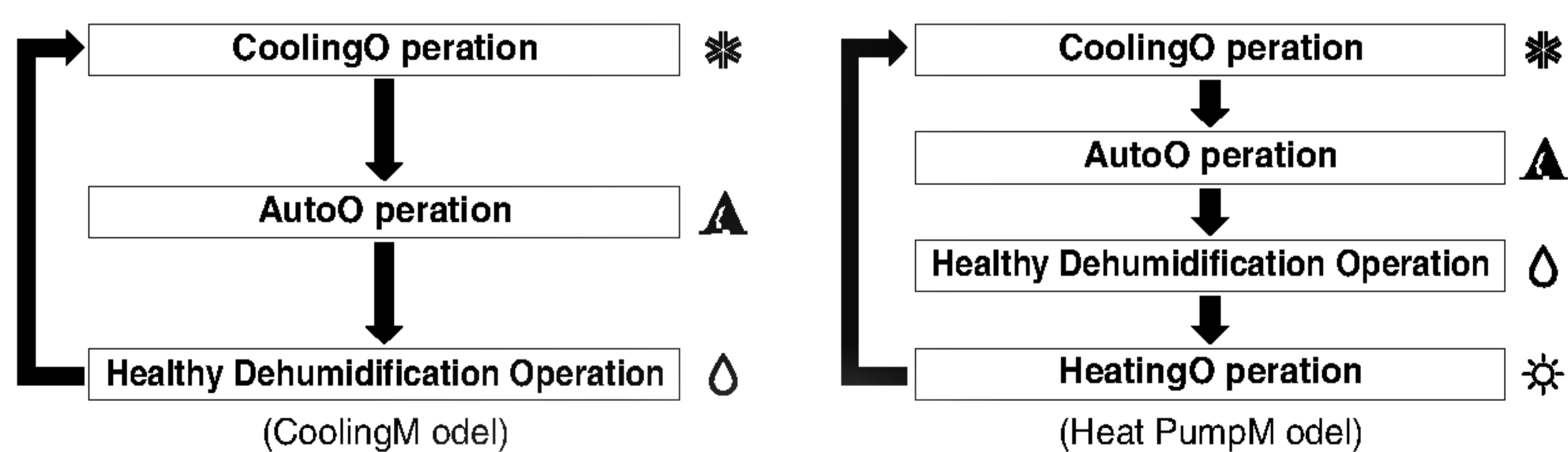



Features of the Remote Control- Door Opened

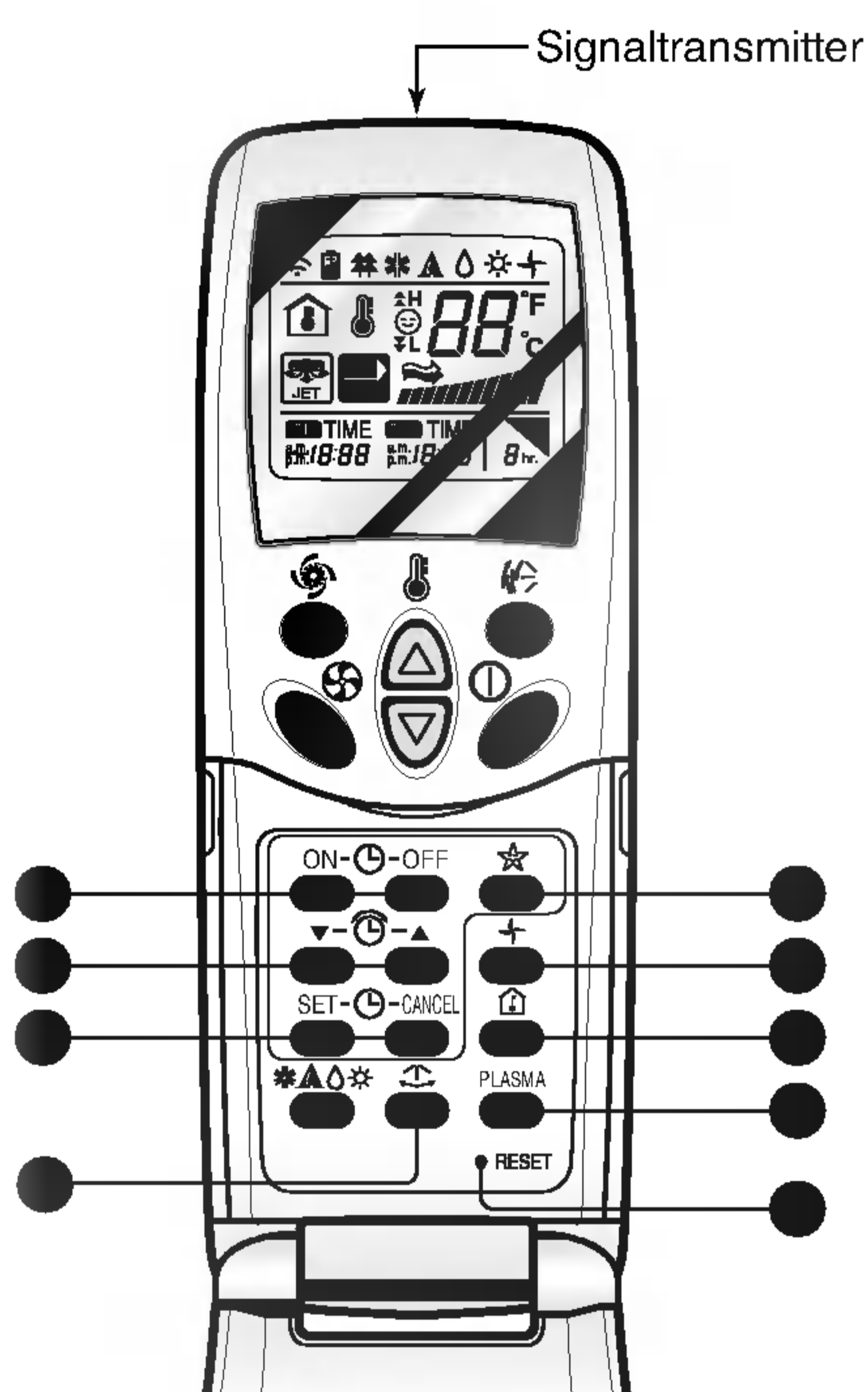

- **ON/OFF TIMER BUTTONS**
Used to set the time of starting and stopping operation.
- **TIME SETTING BUTTONS**
Used to adjust the time, (See page 13)
- **TIMER SET/CANCEL BUTTONS**
Used to set the timer when the desired time is obtained and to cancel the Timer operation. (See page 13)
- **SLEEP MODE AUTO BUTTON**
Used to set Sleep Mode Auto operation. (See page 13)
- **AIR CIRCULATION BUTTON**
Used to circulate the room air without cooling or heating (turns indoor fan on/off). (See page 14)
- **ROOM TEMPERATURE CHECKING BUTTON**
Used to check the room temperature.
- **PLASMA**
Used to start or stop the plasma-purification function. (See page 12)
- **HORIZONTAL AIRFLOW DIRECTION CONTROL BUTTON (NOT ON ALL MODELS)**
Used to set the desired horizontal airflow direction. (See page 14)
- **RESET BUTTON**
Used prior to resetting time or after replacing batteries.

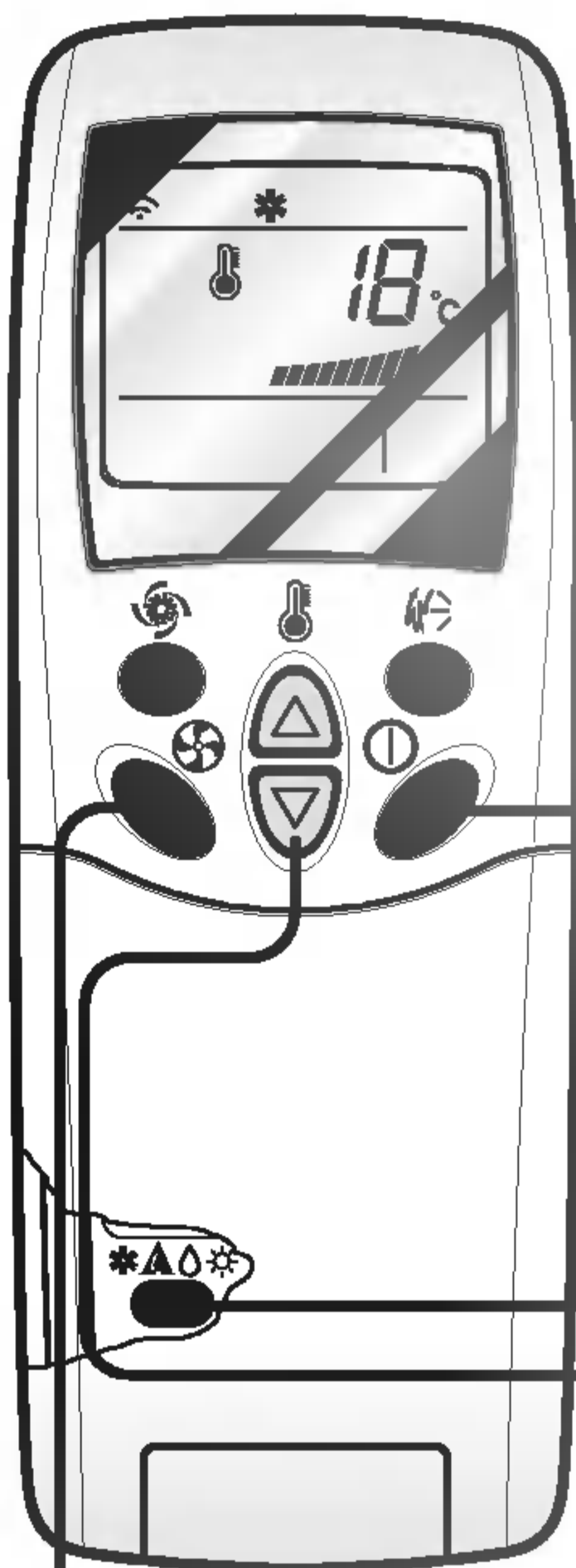

How to use the Operation Mode Selection button

Cooling Operation

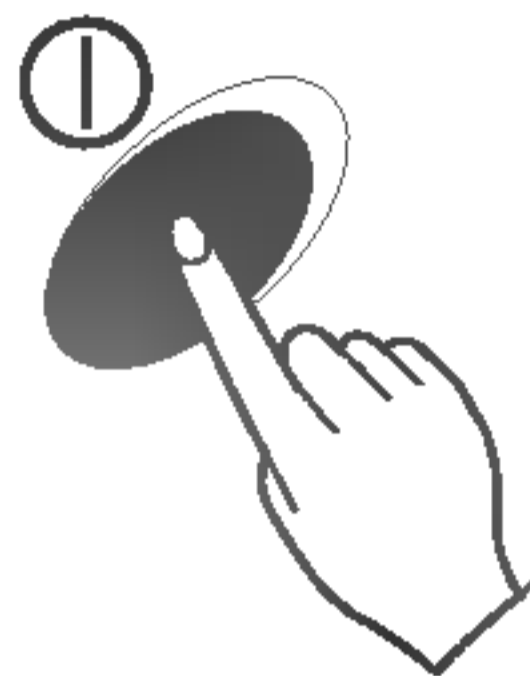

- 1** Press the Start/Stop button. The unit will respond with a beep.

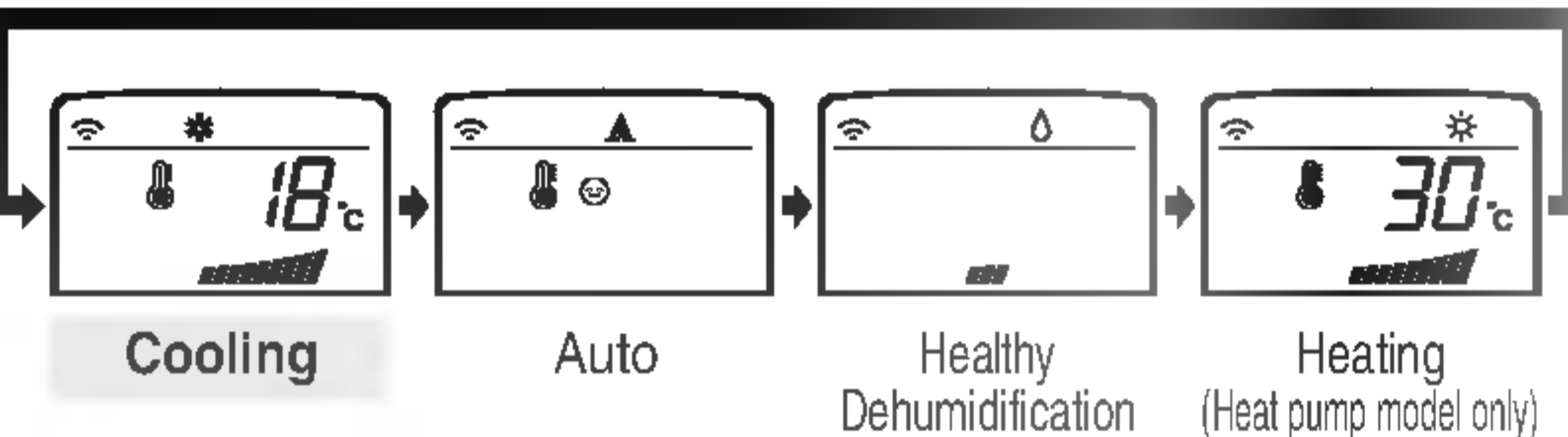
- 2** Open the door on the remote control. To select **Cooling Operation**, press the Operation Mode Selection button. Each time the button is pressed, the operation mode is shifted in the direction of the arrow.

- 3** Close the door on the remote control. Set the temperature higher than the room temperature. The temperature can be set within a range of 18°C~30°C in 1°C increments.

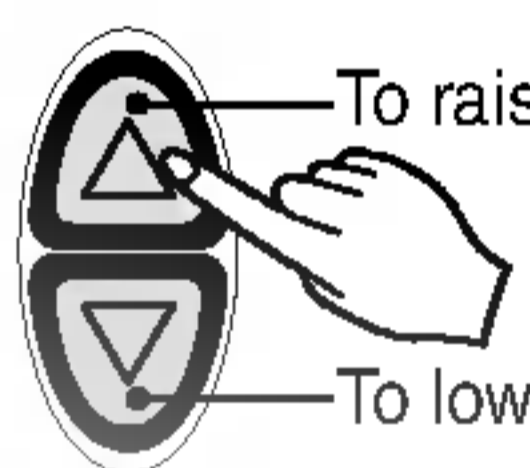

To raise the temperature
To lower the temperature
- 4** Set the fan speed with the door of the remote control still closed. You can select the fan speed in four steps—low, medium, high or CHAOS. Each time the button is pressed, the fan speed mode is shifted.



Natural wind by the CHAOS logic

- For more fresh feeling than other fan speed, press the Indoor Fan Speed Selector and set to CHAOS mode. In this mode, the wind blows like natural breeze by automatically changing fan speed according to the CHAOS logic.



Auto Operation

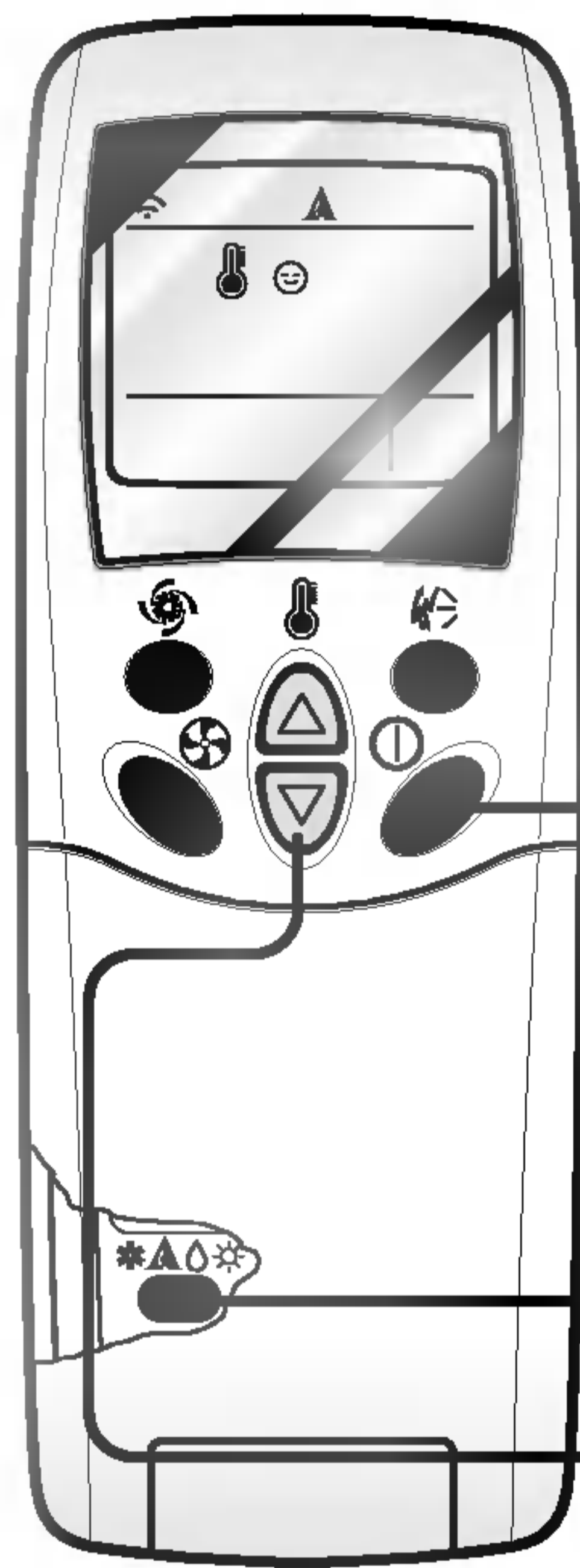

1

Press the Start/Stop button.
The unit will respond with a beep.

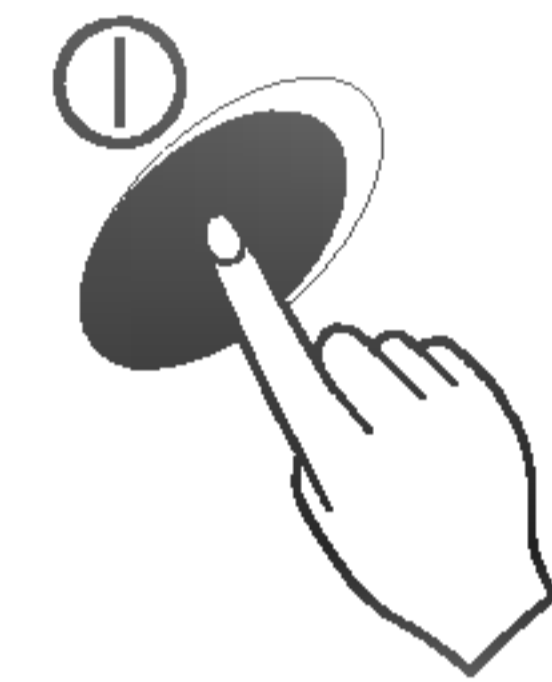

2

Open the door on the remote control. To select **Auto Operation**, press the Operation Mode Selection button. Each time the button is pressed, the operation mode is shifted in the direction of the arrow.

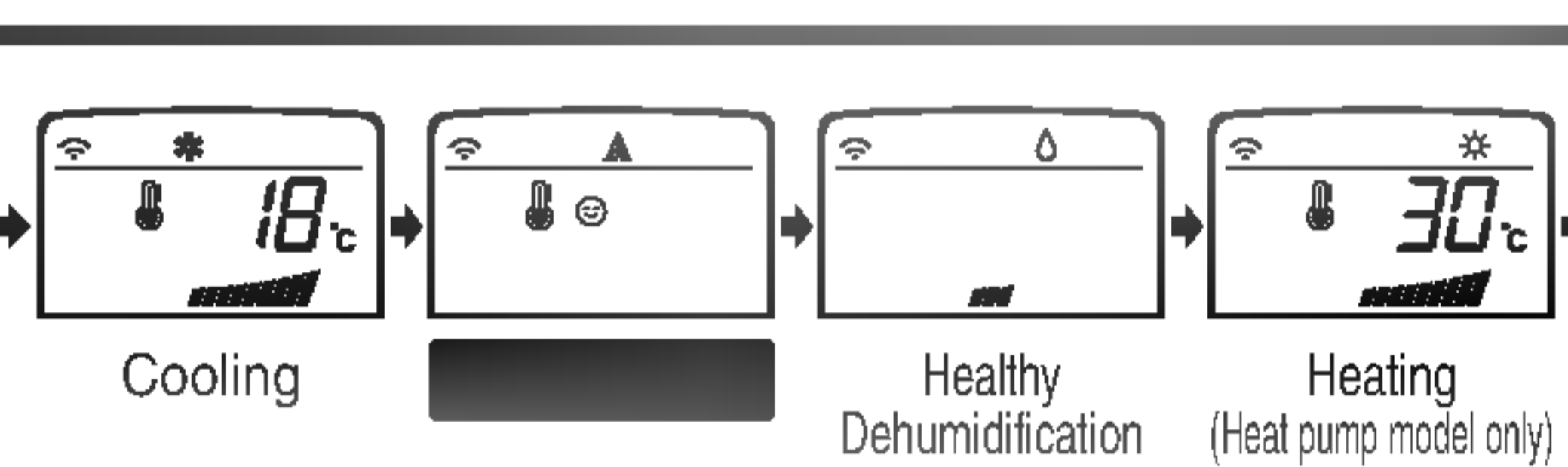

3

The temperature and fan speed are automatically set by the electronic controls based on the actual room temperature. If you want to change the set temperature, close the door on the remote control and press the Room Temperature Setting buttons. The cooler or warmer you feel, the more times (up to two times) you should press the button. The set temperature will be changed automatically.

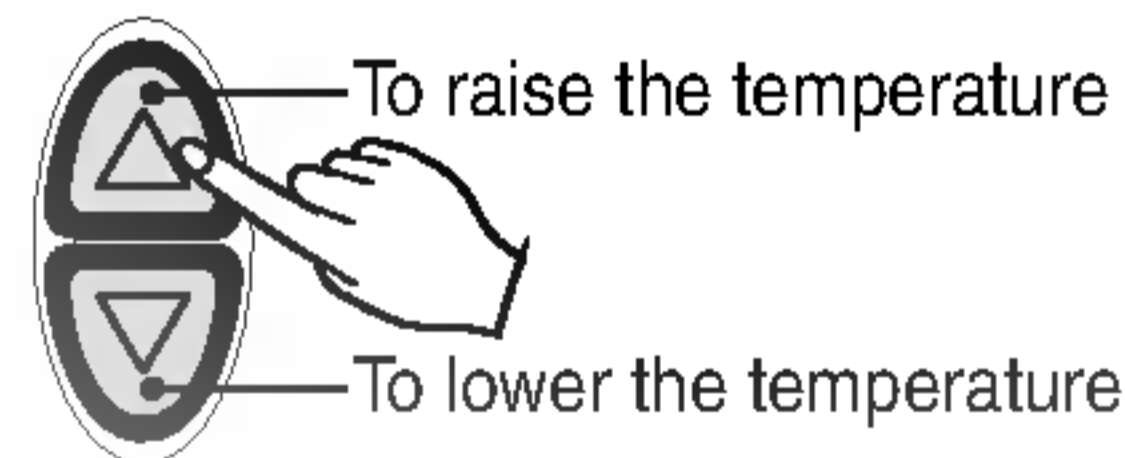

During Auto Operation:

- You cannot switch the indoor fan speed. It has already been set by the Fuzzy rule.
- If the system is not operating as desired, manually switch to another mode. The system will not automatically switch from the cooling mode to the heating mode, or from heating mode to cooling mode, it must be done by manually resetting.
- During Auto Operation, pressing the chaos swing button makes the horizontal louvers swing up and down automatically. If you want to stop auto-swing, press the chaos swing button again.

Healthy Dehumidification Operation

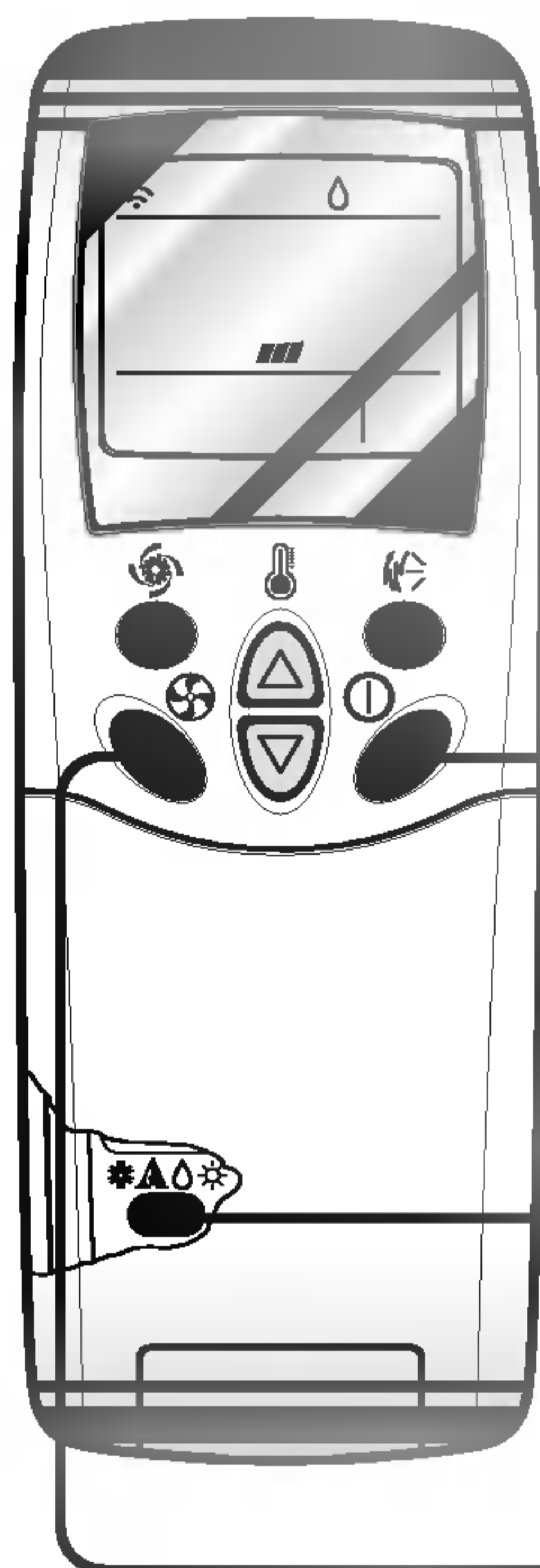

- 1** Press the Start/Stop button. The unit will respond with a beep.

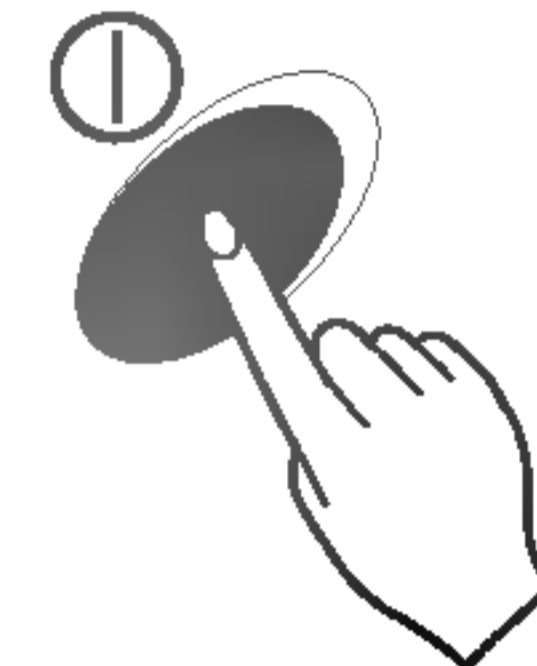

- 2** Open the door on the remote control. To select **Healthy Dehumidification Operation**, press the Operation Mode Selection button. Each time the button is pressed, the operation mode is shifted in the direction of the arrow.

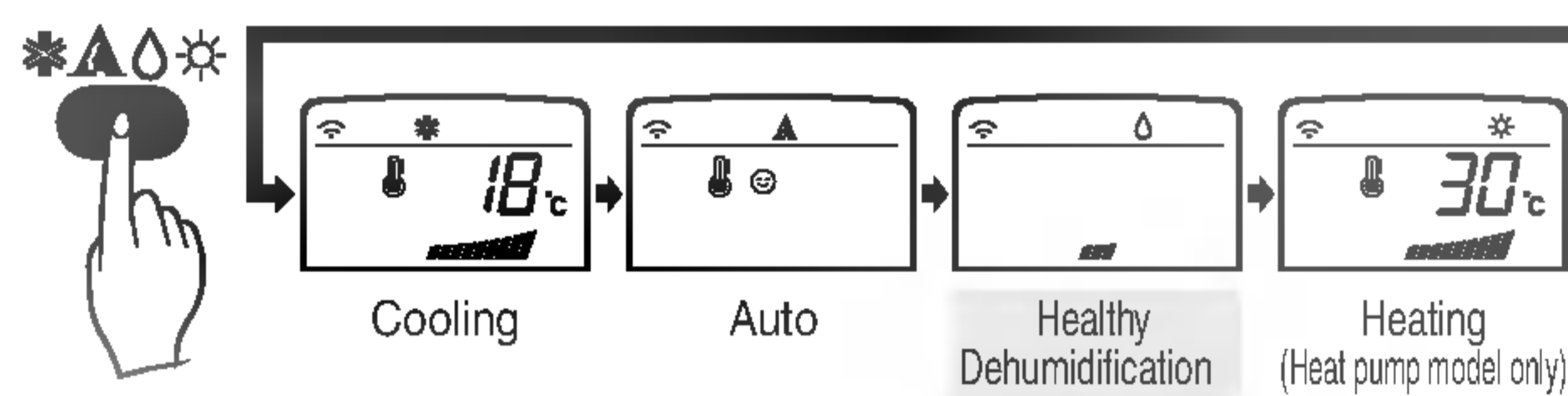

- 3** Set the fan speed again with the door of the remote control still closed. You can select the fan speed in four steps—low, medium, high, or CHAOS. Each time the button is pressed, the fan speed mode is shifted.



Natural wind by the CHAOS logic

- Formorefresh feelingt hano therf ans peed, p resst hel ndoorF an SpeedS electora nds ett oC HAOSm ode. l nt hism ode, t hew ind blowsl iken aturalb reezeb ya utomaticalyc hangingf ans peed accordingt ot heC HAOSI ogic.

During Healthy Dehumidification Operation:

- If you select the dehumidification mode on the operation selection button, the A/C starts to run the dehumidification function. It automatically sets the room temp. and airflow volume to the best condition for dehumidification, based on the sensed current room temp. In this case, however, the setting temp. is not displayed in the remote control and you are not able to control the room temp. either.
- During the healthy dehumidification function, the airflow volume is automatically set according to the optimization algorithm responding to the current room temp. status which makes the room condition healthy and comfortable even in the high humidity season.



Heating Operation(Heat pump model only)

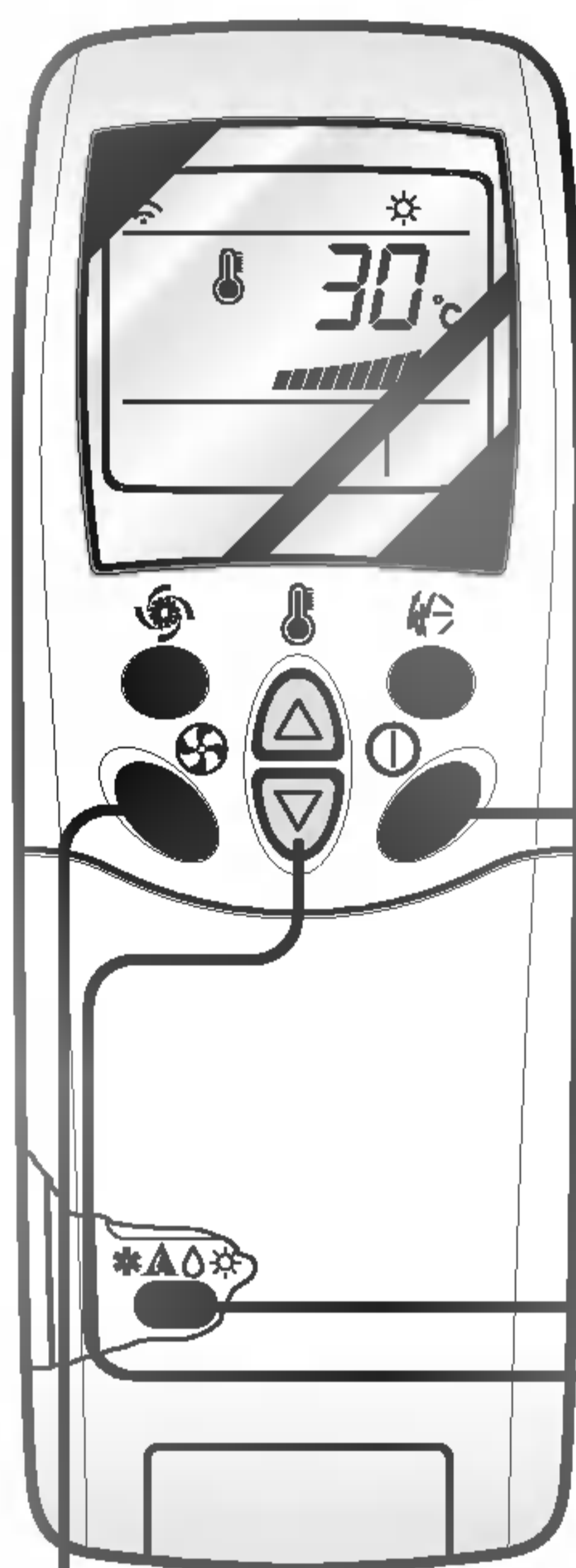

1

Press the Start/Stop button.
The unit will respond with a beep.

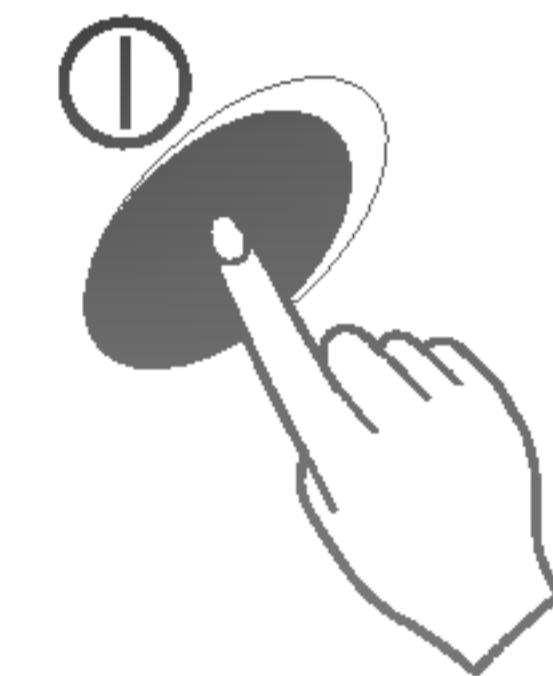

2

Open the door on the remote control. To select **Heating Operation**, press the Operation Mode Selection button. Each time the button is pressed, the operation mode is shifted in the direction of the arrow.

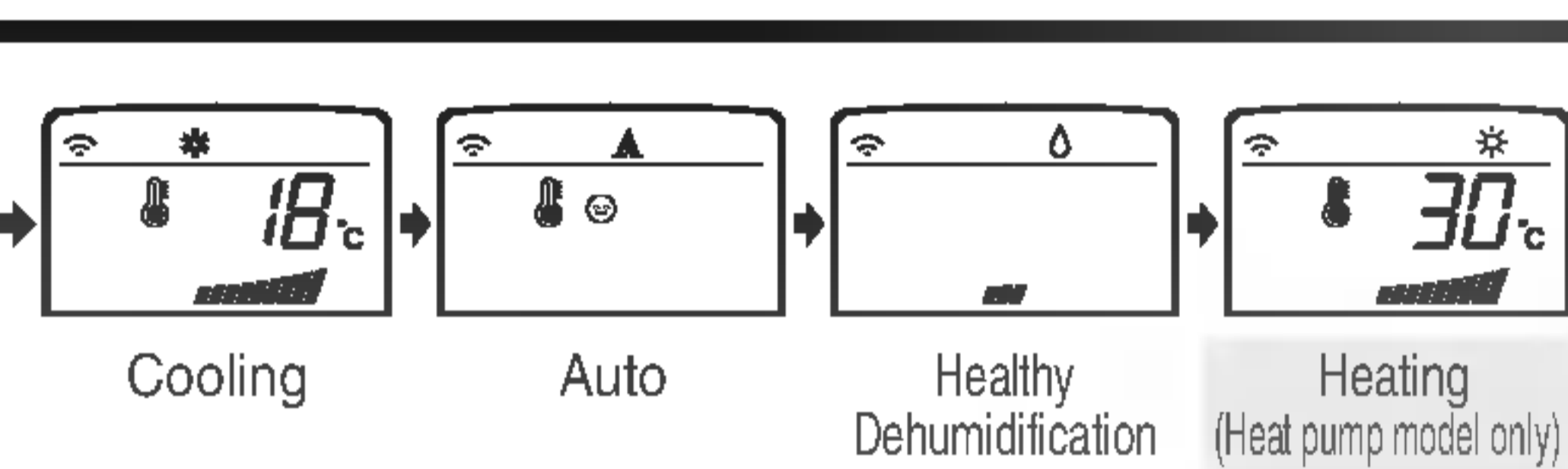

3

Close the door on the remote control. Set the temperature higher than the room temperature. The temperature can be set within a range of 16°C~30°C in 1°C increments.

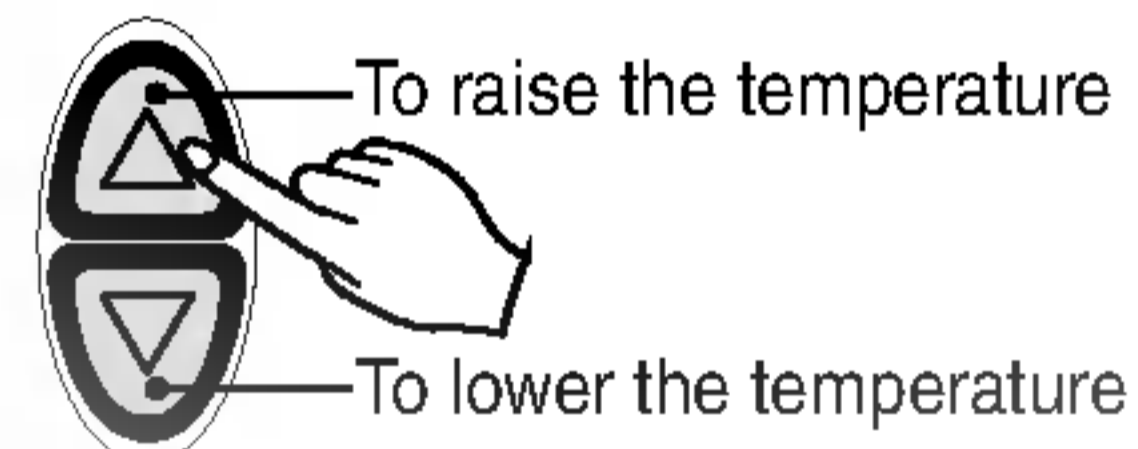

4

Set the fan speed again with the door of the remote control still closed. You can select the fan speed in four steps—low, medium, high or CHAOS. Each time the button is pressed, the fan speed mode is shifted.



Natural wind by the CHAOS logic

- For more fresh feeling than other fan speed, press the Indoor Fan Speed Selector and set to CHAOS mode. In this mode, the wind blows like natural breeze by automatically changing fan speed according to the CHAOS logic.



Jet Cool Operation

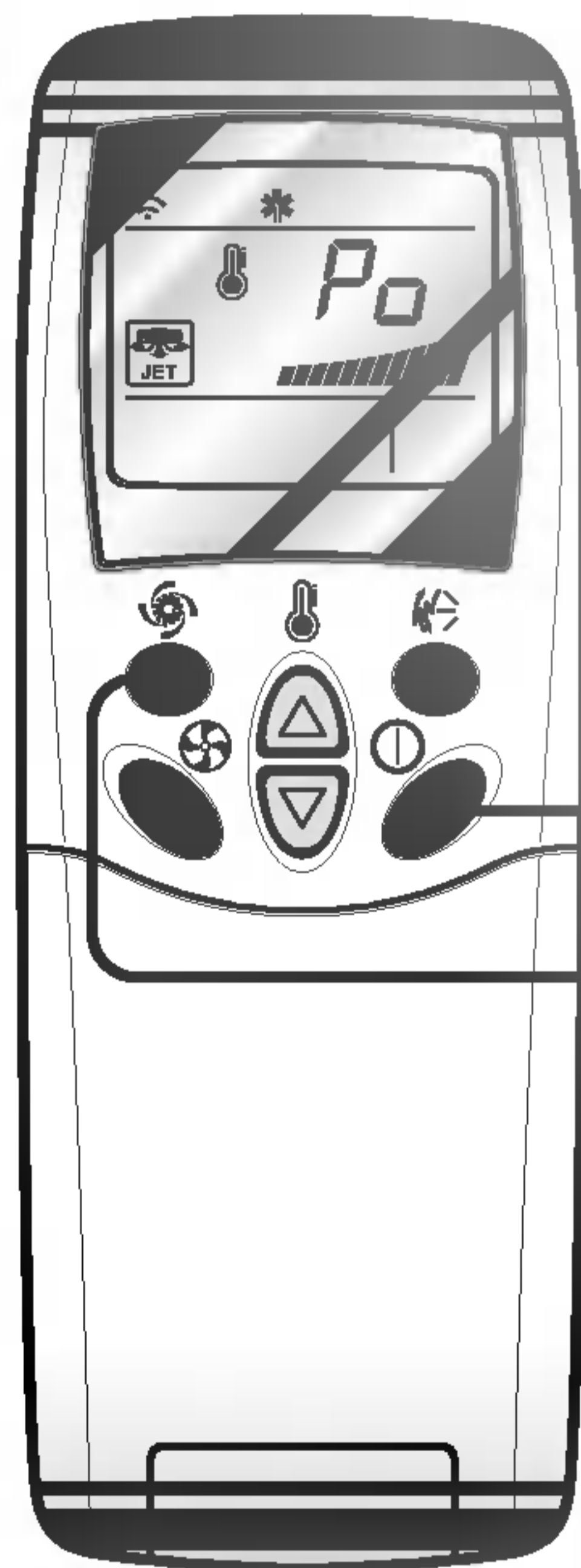

1

Press the Start/Stop button.
The unit will respond with
a beep.



2

Press the Jet **Cool** button to operate
the speed cooling mode and the unit
will operate in super high fan speed
on cooling mode for 30 minutes.



3

To cancel the Jet Cool mode, press the Jet Cool button
again or the fan speed button or the room temperature
setting button and the unit will operate in high fan speed on
cooling mode.

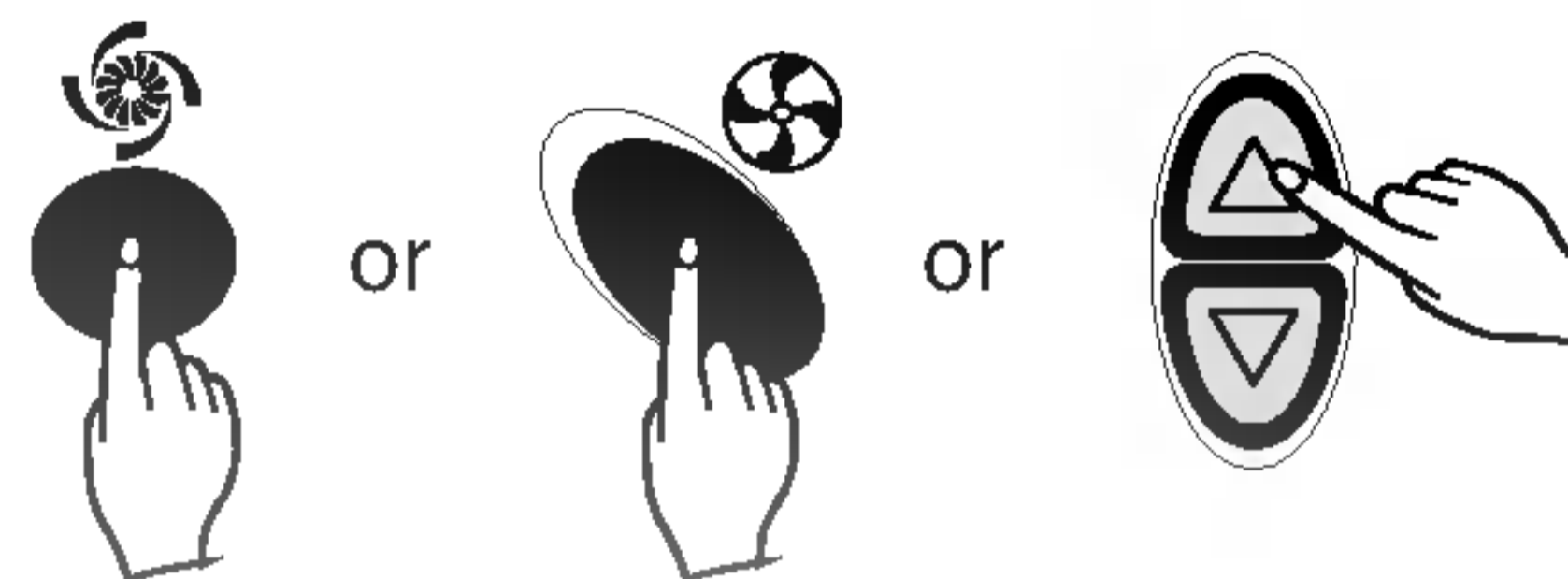

NOTE:

- During the JET COOL function at any moment, the A/C starts to blow the cool air at extremely high speed for 30 minutes setting the room temp. automatically to 18°C. It is especially used to cool the room temp. in the shortest time in a hot summer. In heat pump mode or neurofuzzy mode, however, the JET COOL function is not available.
- In order to return to the normal cooling mode from the JET COOL mode, you just press either the operation mode selection button, airflow volume selection or temp. setting button or the JET COOL button again.





PLASMA Purification Operation (Optional)

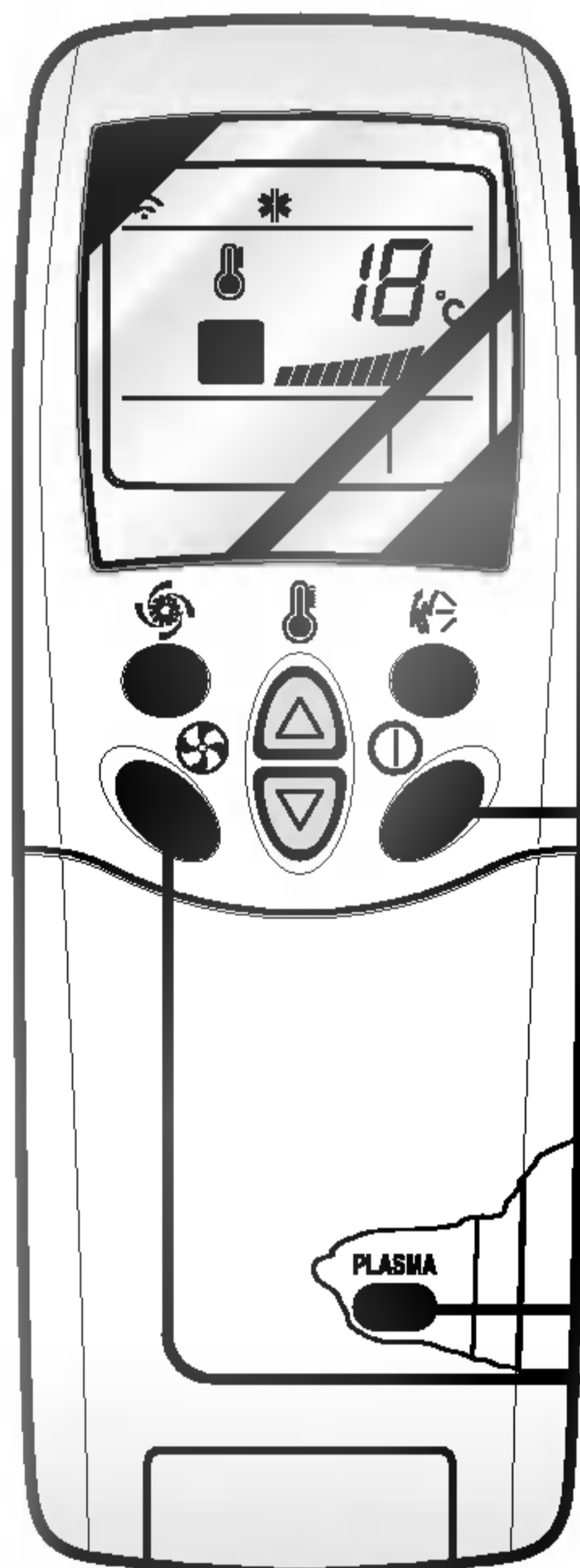

1

Press the Start/Stop button.
The unit will respond with a beep.

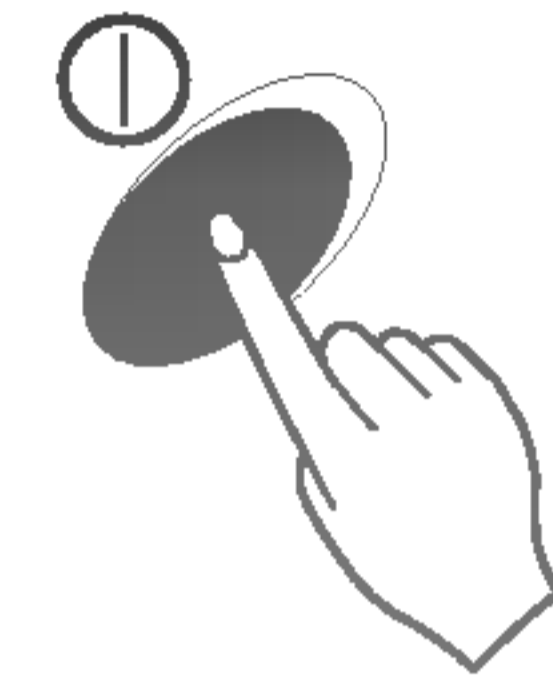

2

Open the door on the remote control.
Press the PLASMA air purifying operation ON/OFF button.
Operation will start when the button is pressed and stop when the button is pressed again.

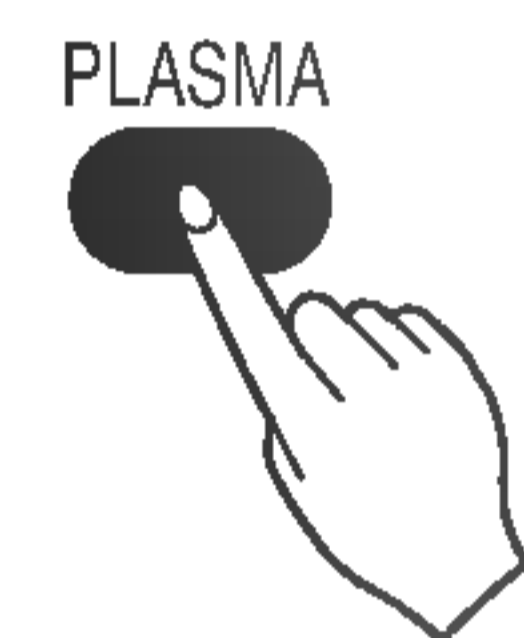

3

Set the fan speed again with door of the remote control closed. You can select the fan speed in four steps-low, medium, high or CHAOS. Each time the button is pressed, the fan speed mode is shifted.



* Air purifying operation (PLASMA) can be with cooling, Heating or any other operations.

PLASMA Air Purifying Operation only

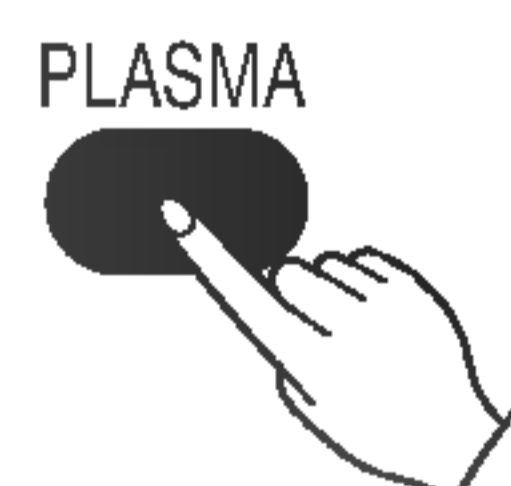
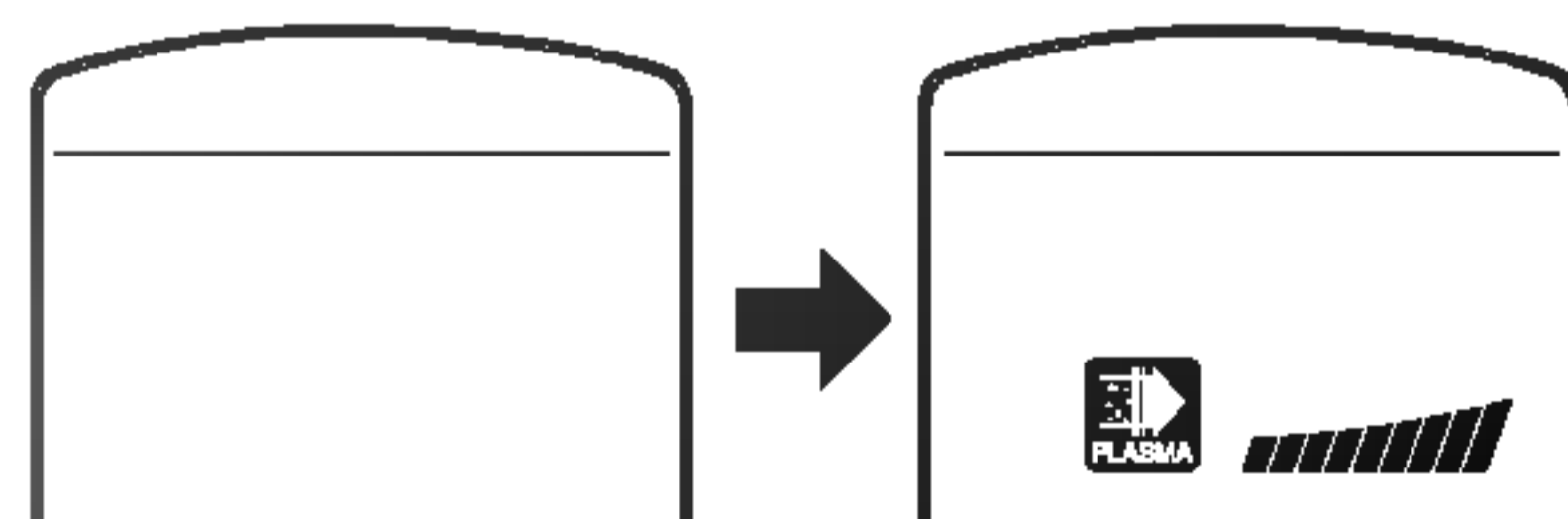

If you press the only PLASMA button, PLASMA air purifying operates only.

Then, fan speed is low. You can select the fan speed in four steps-low, medium, high or CHAOS.

Each time the button () is pressed, the fan speed mode is shifted.

Additional features

Sleep Mode

- Press the Sleep Mode Auto button to set the time you want the unit to turn off automatically.
- The Timer is programmed in one-hour increments by pressing the Sleep Mode Auto button 1 to 7 times.
The sleep mode is available for 1 to 7 times. To alter the time period in steps of 1 hour, press the Sleep Mode Button while aiming at air conditioner.
- Make sure the Sleep Mode Auto LED lights up.



To cancel the Sleep Mode, press the sleep Mode Auto button several times until the star (★) disappears from the operation display.

Note: 1. The Sleep Mode will be operated at slow fan speed (cooling) or medium fan speed (heat pump only) for quiet sleeping.
2. Remote Control will display Fan Speed. Set before sleep mode although Unit Fan Speed changes.

IN COOLING MODE : The temperature will automatically rise by 1°C over the next 30 minutes and by 2°C in 1 hour for comfortable sleeping.

Setting the Time

- Time can be set only when you have pressed the Reset button. If you have just replaced the batteries, the Reset button should be pressed to reset the time.

Press the Start/Stop button.



- Press the Time Setting buttons until the desired time is set.



- Press the Timer SET button.



Note: Check the indicator for A.M. and P.M.

Delay Start/Pre-Set Stop

- Make sure the time is set correctly on the remote control display.

- Press the ON/OFF Timer buttons to turn Timer on or off.



- Press the Time Setting buttons until the desired time is set.



- Press the selected on/off setting by pressing the Timer SET button while aiming the remote control at the signal receptor.



To cancel the timer setting

Press the Timer Cancel button while aiming remote control at the signal receptor.
(The timer lamp on the air conditioner and the display will go out.)



NOTE: Select one of the following four types of operation.

with the unit running



Delay OFF Timer



Delay ON Timer



Delay OFF and ON Timer



Delay ON and OFF Timer



Vertical Airflow Direction Control

The up/down airflow (Vertical Airflow) can be adjusted by using the remote control.



- Press the Start/Stop button to start the unit.
- Press Chaos Swing button and the louvers will swing up and down. Press the Chaos Swing button again to set the vertical louver at the desired airflow direction.



Note:

- If you press the CHAOS swing button, the horizontal airflow direction is changed automatically based on the CHAOS algorithm to distribute the air in the room evenly and at the same time to make the human body feel most comfortable, as if enjoying a natural breeze.
- Always use the remote control to adjust the up/down airflow direction. Manually moving the vertical airflow direction louver by hand, could damage the air-conditioner.
- When the unit is shut off, the up/down airflow direction louver will close the air outlet vent of the system.

To adjust left/right(Horizontal Airflow) direction

Caution : Ensure that the unit is turned off before adjusting the horizontal airflow direction control. Carefully open vertical louver to allow access to the horizontal airflow direction.



Adjust the left/right airflow direction by hand.



Horizontal Airflow Direction Control (Option)

The left/right(Horizontal Airflow) can be adjusted by using the remote control. Press the Start/Stop button to start the unit.

Open the door on the remote control. Press the Airflow Direction Start/Stop button and the louvers will swing left and right. Press the Horizontal Airflow Direction Control Button again to set the horizontal louver at the desired airflow direction.

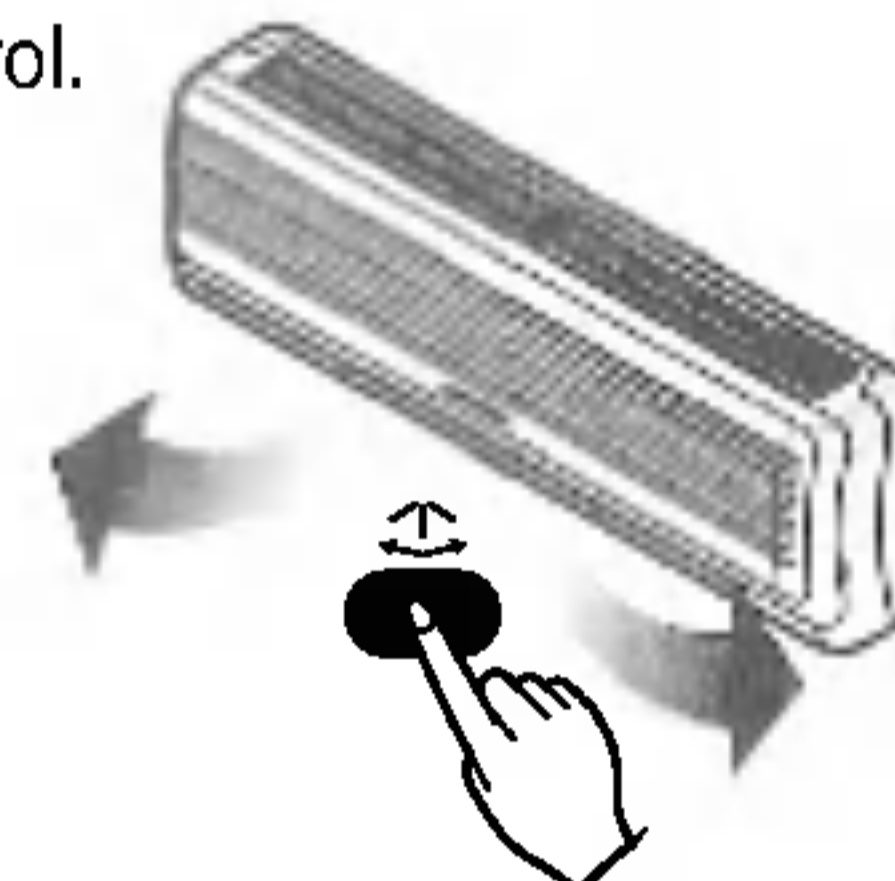

Air Circulation Mode

Circulates the room air without cooling or heating.

- Press the Start/Stop button. the unit will respond with a beep.
- Open the door on the remote control. Press the Air Circulation button. Close the door on the remote control. Now each time that you press the Indoor Fan Speed Selector, the fan speed is shifted from low to CHAOS and back to low again.

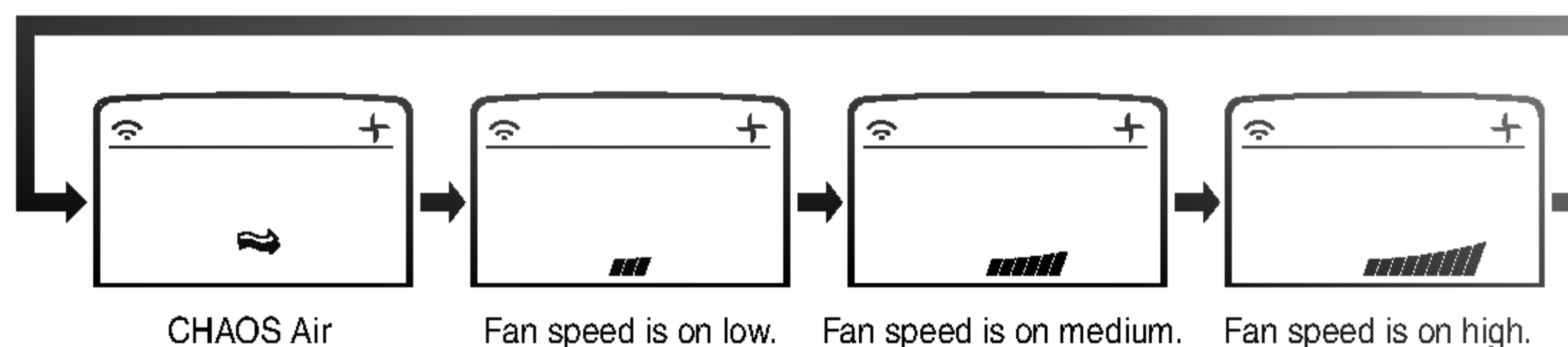

Note:

- **CHAOS Air** economizes power consumption and prevents overcooling. The fan speed is automatically changed from high to low or vice versa, depending on the ambient temperature.



Forced Operation

Operation procedures when the remote control can't be used.
The operation will be started if the power button is pressed.
If you want to stop operation, re-press the button.

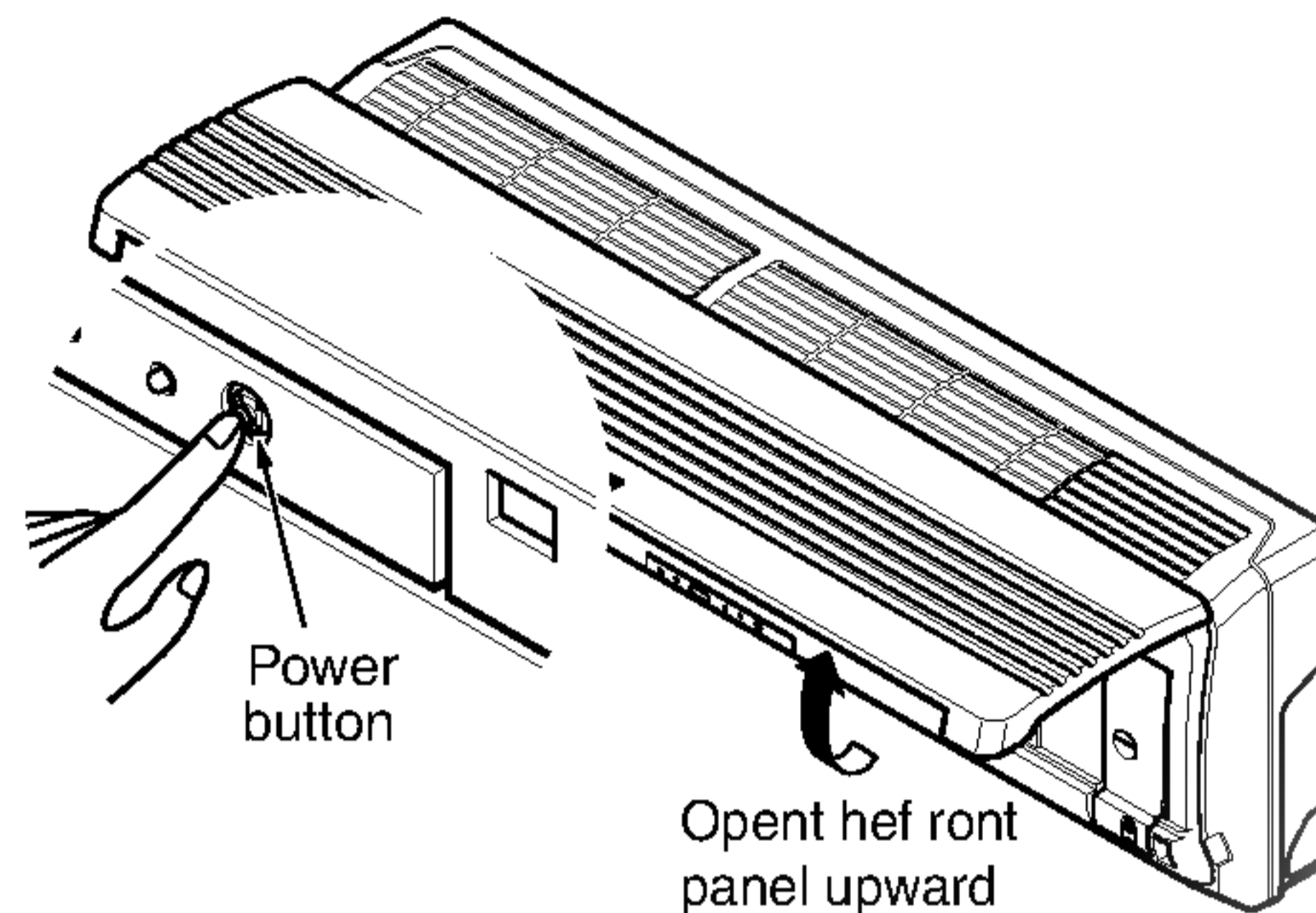

	Cooling Model	Heat pump Model		
		Room Temp. $\geq 24^{\circ}\text{C}$	$21^{\circ}\text{C} \geq$ Room Temp. $< 24^{\circ}\text{C}$	Room Temp. $< 21^{\circ}\text{C}$
Operating mode	Cooling	Cooling	Healthy Dehumidification	Heating
Indoor FAN Speed	High	High	High	High
Setting Temperature	22°C	22°C	23°C	24°C

Test operation

During the TEST OPERATION, the unit operates in cooling mode at high speed fan, regardless of room temperature and resets in 18 minutes.

During test operation, if remote controller signal is received, the unit operates as remote controller sets. If you want to use this operation, open the front panel upward and Press the power button let it be pressed for about 3 seconds.

If you want to stop the operation, re-press the button.

Auto restart

In case the power comes on again after a power failure, Auto Restarting Operation is the function to operate procedures automatically to the previous operating conditions.

So there is no need of activating this function by pressing any key or button.

In the initial mode, the fan operates at a low speed and the compressor starts 2.5~3 minutes later.

As the compressor starts, the fan speed also resumes its previous setting mode.

Helpful information

Fan speed and cooling capacity.

The cooling capacity indicated in the specification is the value when the fan speed is set to high, and the capacity will be lower at low or medium fan speed.

High fan speed is recommended when you wish to cool the room quickly.

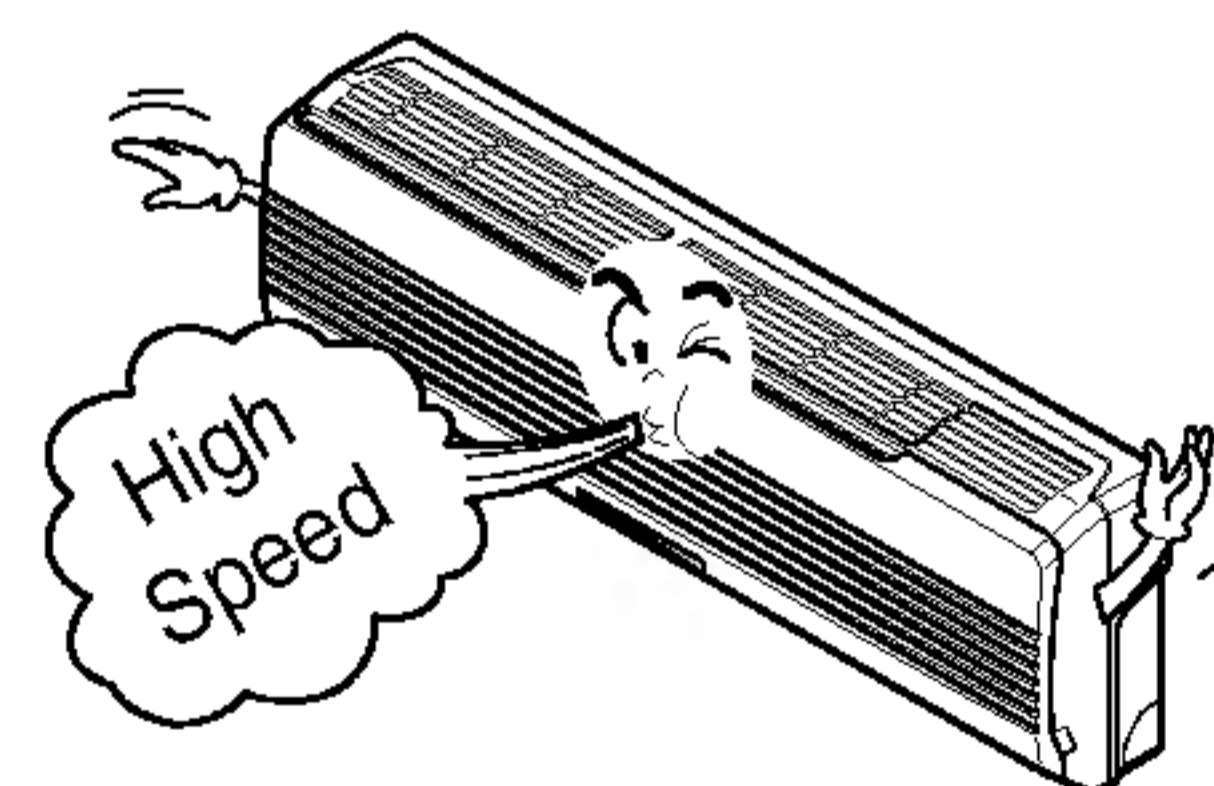

Care and maintenance of the air conditioner

CAUTION: Before performing any maintenance, turn off the main power to the system.

Indoor Unit

Grille, Case, and Remote Control

- Turn the system off before cleaning. To clean, wipe with a soft, dry cloth. Do not use bleach or abrasives.

NOTE:

Supply power must be disconnected before cleaning the indoor unit.

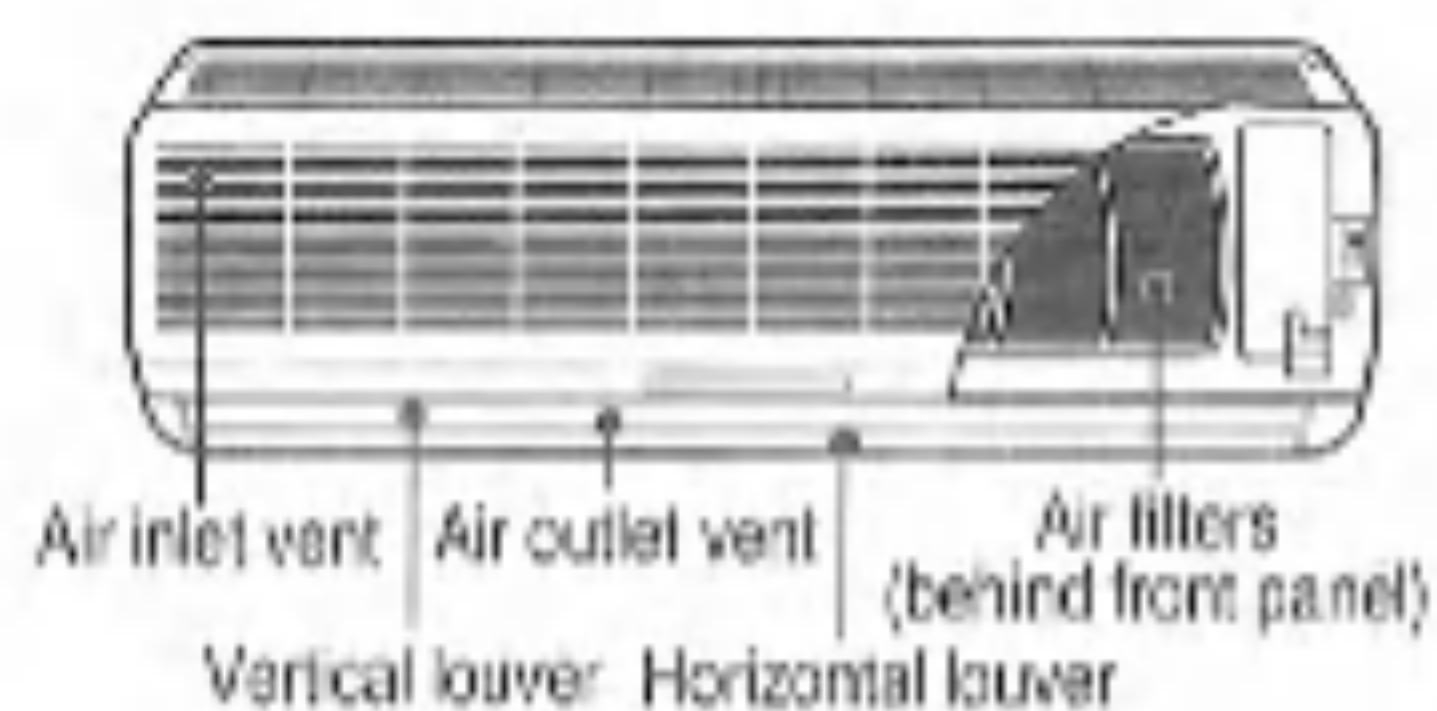

AIR FILTERS

The air filters behind the front grille should be checked and cleaned once in every 2 weeks or more often if necessary.

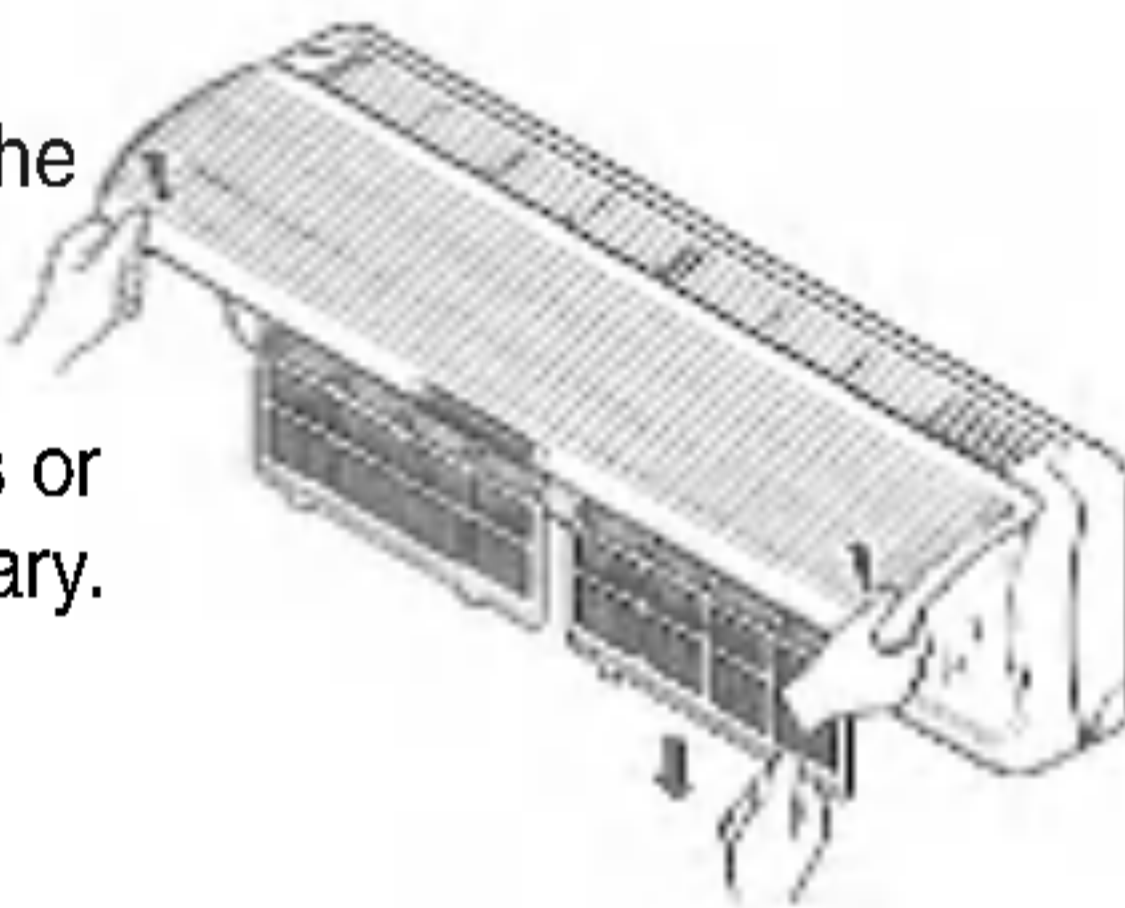

PLASMA FILTER, DEODORIZER FILTER(OPTIONAL)

The PLASMA filter behind the air filters should be checked and cleaned once in every 3 months or more often if necessary.



Don't touch this PLASMA Filter within 10 seconds after opening the inlet grille, it may cause an electric shock.

- Never use any of the following:

- Water hotter than 40°C
Could cause deformation and/or discoloration.
- Volatile substances
Could damage the surfaces of the air conditioner.



- Lift the front access panel and pull the filter tab slightly forward to remove the filter.
- Clean the filter with a vacuum or warm, soapy water.
 - If dirt is conspicuous, wash with a solution of detergent in lukewarm water.
 - If hot water (40 °C or more) is used, it may be deformed.
- After washing with water, dry well in the shade.
- Re-install the air filter.
- After removing the air filters, pull slightly forward to remove the PLASMA filter.
- Dip the PLASMA filter into the water mixed with neutral detergent, for 20~30 minutes.
- Dry the PLASMA filter in the shade for a day (Especially, the humidity must be removed perfectly on this parts).
- Note the cuts of electric discharge lines.
- Re-install the PLASMA filter to the original position.
- After removing the air filters, pull slightly forward to remove the DEODORIZER filter.
- Dry in the sunlight for two hours.
- Re-install the DEODORIZER filter to the original position.

Replacement of Purifying Filter(Optional)

• Recommended use period : About 2 years

- Open front panel and remove air filters

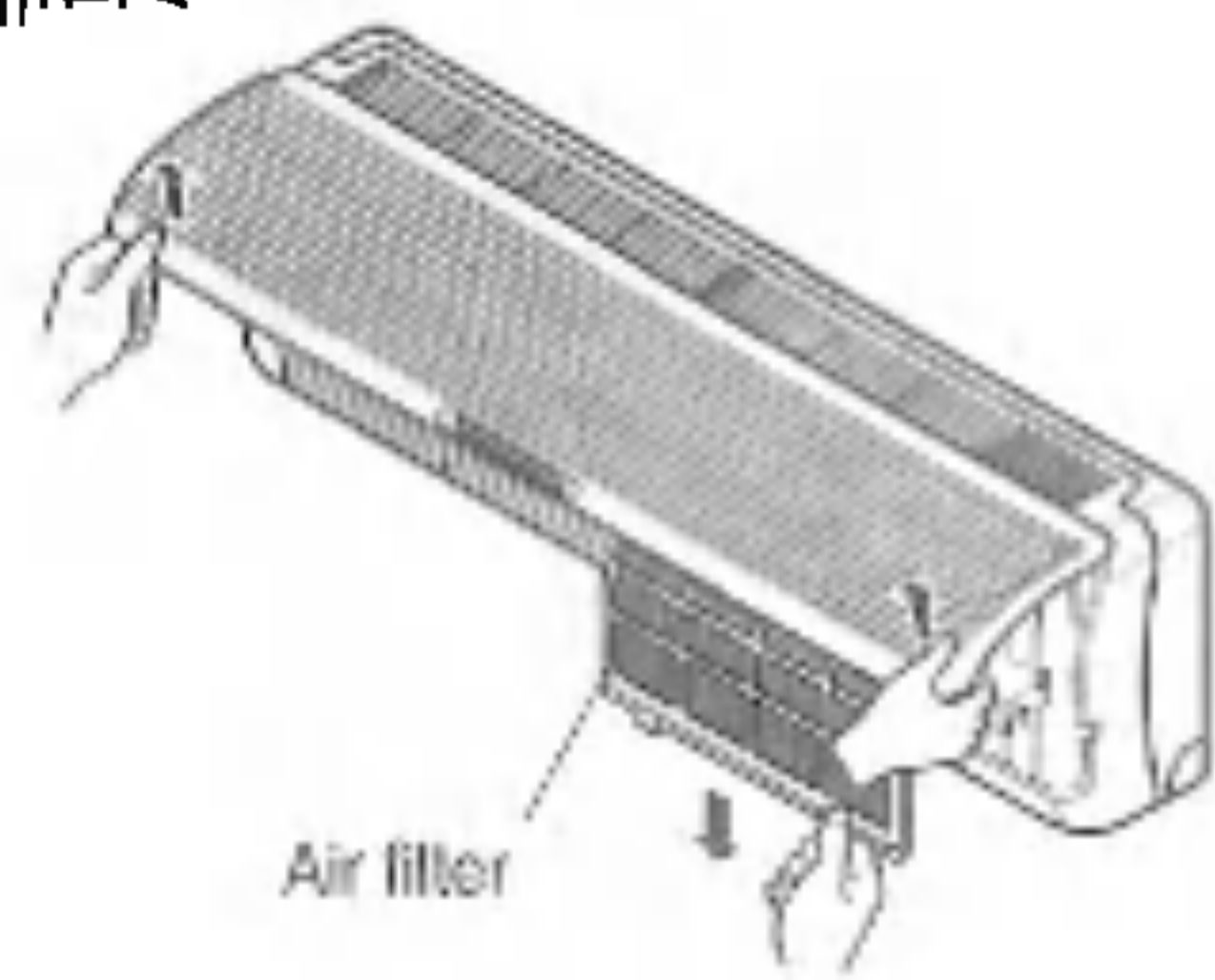

- Remove air purifying filters.

- Insert new air purifying filters.

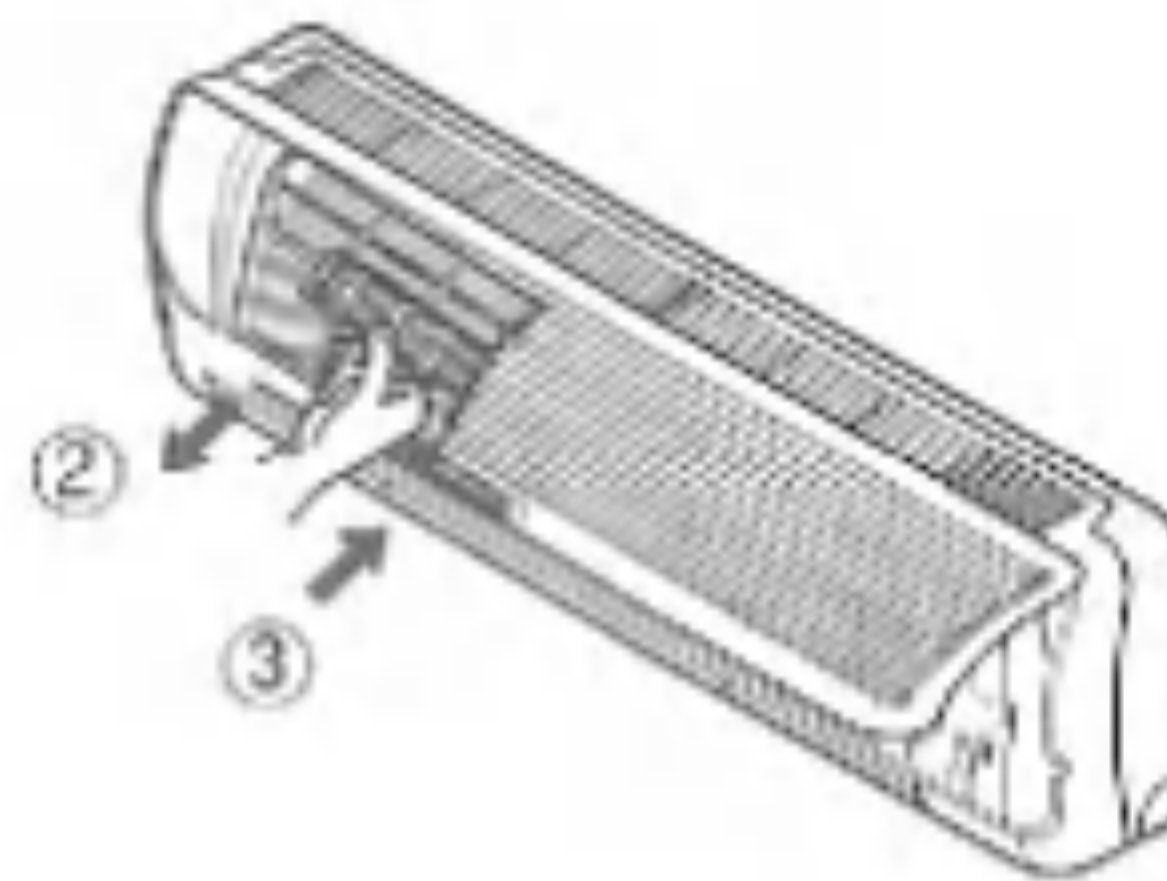

- Reinsert air filters and close front panel

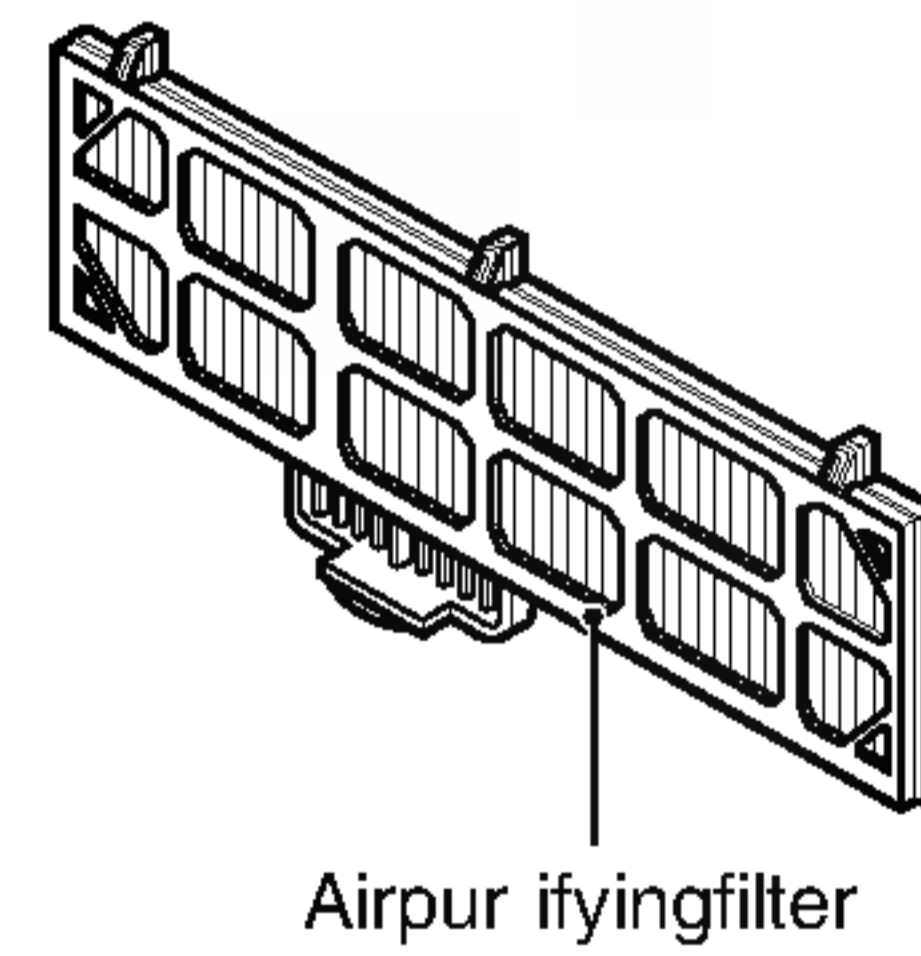
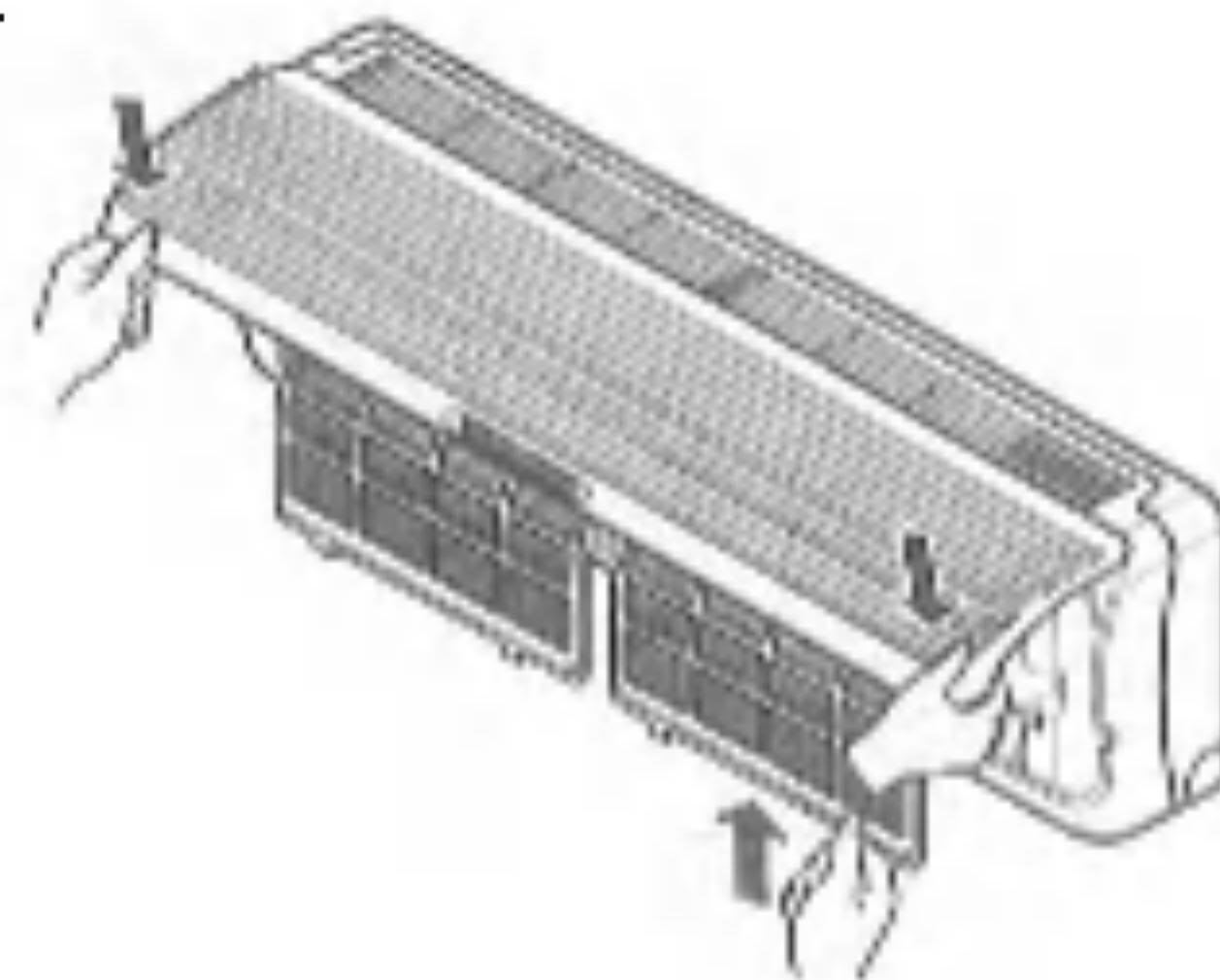

Outdoor Unit

The heat exchanger coils and panel vents of the outdoor unit should be checked regularly. If clogged with dirt or soot, the heat exchanger and panel vents may be professionally steam cleaned.

NOTE:

Dirty or clogged coils will reduce the operating efficiency of the system and cause higher operating costs.

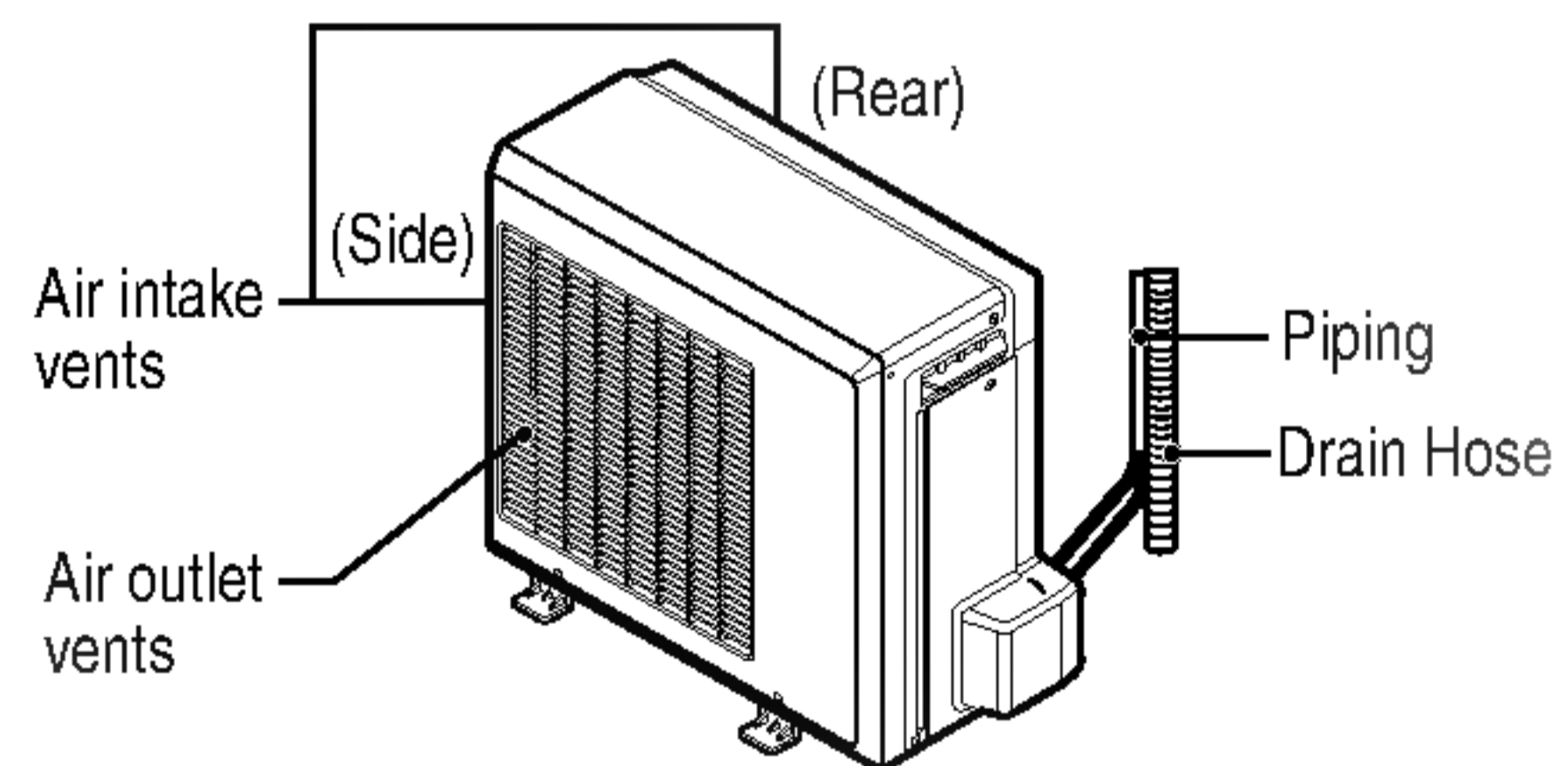
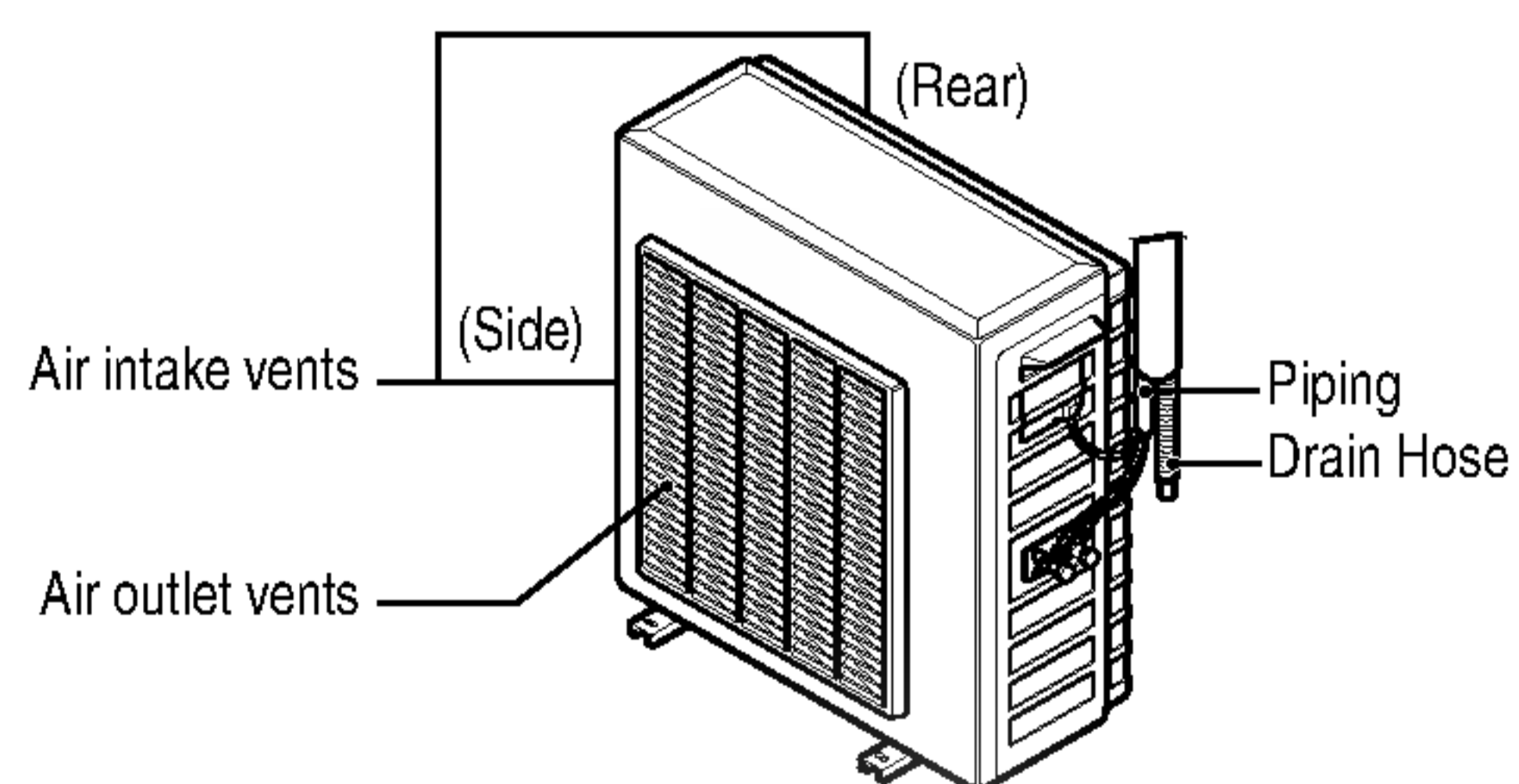
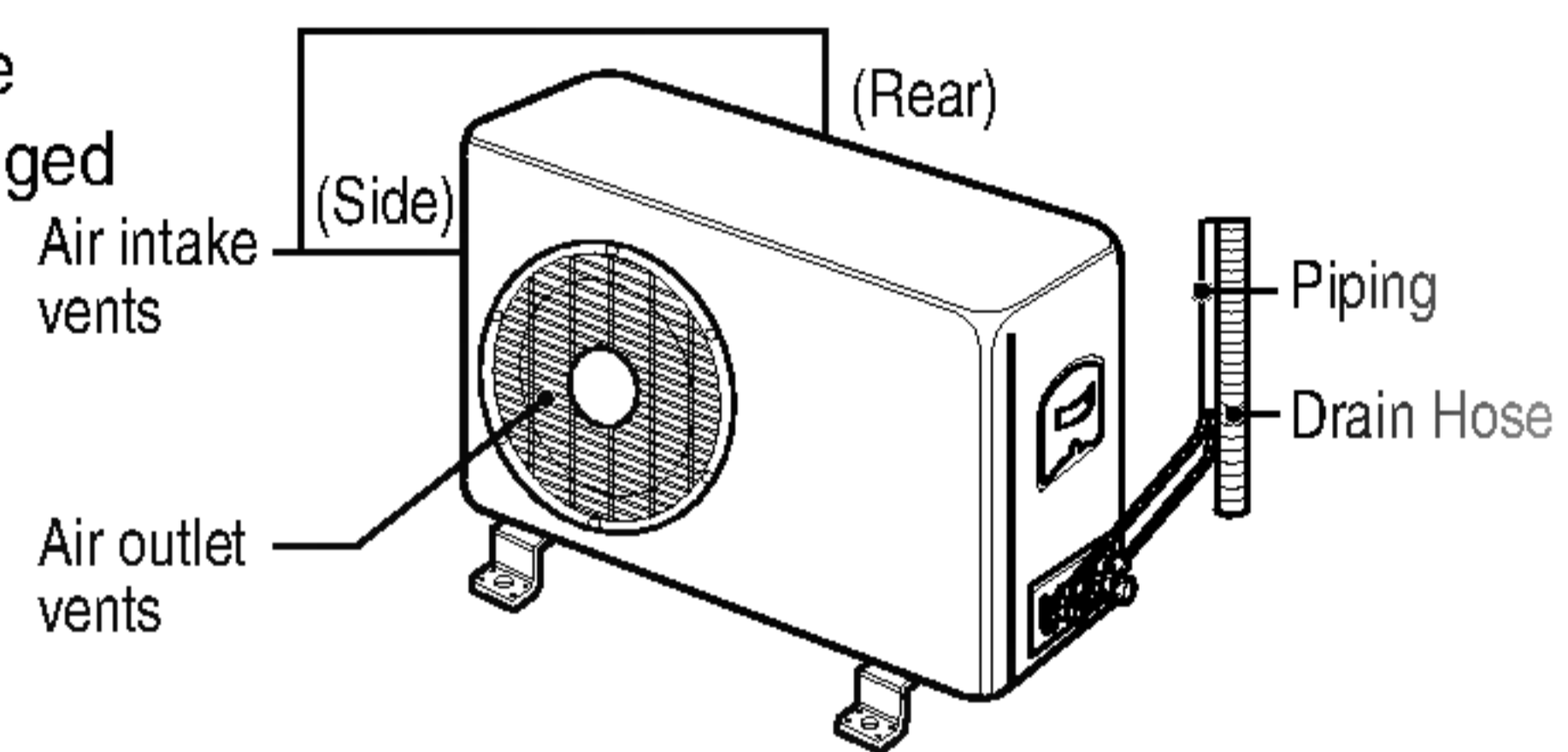

When the air conditioner is not going to be used for a long time.

1 Operate the air conditioner on Air circulation mode (Refer to page 13) for 2 to 3 hours.

- This will dry out the internal mechanisms.

2 Turn off the circuit breaker, and disconnect the plug.



Turn off the circuit breaker when the air conditioner is not going to be used for a long time.
Dirt may collect and may cause a fire.

3 Remove the batteries from the remote control.

1 Clean the air filter and install it in the indoor unit.
(Refer to page 17 for cleaning filters.)

2 Check that the air inlet and outlet of the indoor/outdoor unit are not blocked.

Operation Tips

This is not good for the health and wastes electricity.

Do not let direct sunshine enter the room when the air conditioner is in operation.

Adjust the vertical and horizontal airflow direction to ensure a uniform temperature in the room.

Avoid opening doors and windows as much as possible to keep the cool air in the room.

Blockages in the air filter reduces the airflow and lowers the cooling and dehumidifying effects. Clean at least once in every two weeks.

Since windows are kept closed, it is a good idea to open them and ventilate the room now and then.

Before you call for service...



Troubleshooting Tips! Save time and money!

Check the following points before requesting repairs or service.... If the fault persists, please contact your dealer or service center.

Case	Explanation	See page
The air conditioner does not operate.	• Have you made a mistake in timer operation?	13
	• Has the fuse blown or has the circuit breaker been tripped?	-
The room has a peculiar odor.	• Check that this is not a damp smell exuded by the walls, carpet, furniture, or cloth items in the room.	-
It seems that condensation is leaking from the air conditioner.	• Condensation occurs when the airflow from the air conditioner cools the warm room air.	-
Air conditioner does not operate for about 3 minutes when restarted.	• This is the protector of the mechanism. • Wait about three minutes and operation will begin.	-
Does not cool or heat effectively.	• Is the air filter dirty? See air filter cleaning instructions.	16
	• Has the temperature been set incorrectly?	7, 10
	• Are the indoor unit's air inlet or outlet vents obstructed?	-
The air conditioner operation is noisy.	• For a noise that sounds like water flowing. -This is the sound of freon flowing inside the air conditioner unit. • For a noise that sounds like the compressed air releasing into atmosphere. -This is the sound of the dehumidifying water being processed inside the air conditioning unit.	-
Remote control display is faint, or no display at all.	• Are the batteries depleted? • Are the batteries inserted in the opposite (+) and (-) directions?	4
Crack sound is heard.	• This sound is generated by the expansion/constriction of the front panel, etc. due to changes of temperature.	-

NOTE

WATER RESISTANT: The outdoor side of this appliance is WATER RESISTANT.
The indoor side is not water resistant and should not be exposed to excess water.



P/No.:HI03-00344E