



DVD MICRO KARAOKE SYSTEM OWNER'S MANUAL

MODEL : LX-K3350Q
(LX-K3350A/X, LXS-K3350V)
LX-K3340Q
(LX-K3340A/X, LXS-K3340V)



Please read this manual carefully before operating your set.
Retain it for future reference.

Designs and specifications are subject to change without notice for
improvement.

The working life of this product is 7 years since the date of purchase.



WARNING: TO REDUCE THE RISK OF ELECTRIC SHOCK DO NOT REMOVE COVER (OR BACK) NO USER-SERVICEABLE PARTS INSIDE REFER SERVICING TO QUALIFIED SERVICE PERSONNEL.



This lightning flash with arrowhead symbol within an equilateral triangle is intended to alert the user to the presence of uninsulated dangerous voltage within the product's enclosure that may be of sufficient magnitude to constitute a risk of electric shock to persons.



The exclamation point within an equilateral triangle is intended to alert the user to the presence of important operating and maintenance (servicing) instructions in the literature accompanying the appliance.

WARNING: TO REDUCE THE RISK OF FIRE OR ELECTRIC SHOCK, DO NOT EXPOSE THIS PRODUCT TO RAIN OR MOISTURE.

CLASS 1 LASER PRODUCT
 KLASSE 1 LASER PRODUKT
 LUOKAN 1 LASER LAITE
 KLASS 1 LASER APPARAT
 CLASSE 1 PRODUIT LASER

CAUTION:

This Digital Video Disc Player employs a Laser System.

To ensure proper use of this product, please read this owner's manual carefully and retain for future reference, should the unit require maintenance, contact an authorized service location-see service procedure.

Use of controls, adjustments or the performance of procedures other than those specified herein may result in hazardous radiation exposure.

To prevent direct exposure to laser beam, do not try to open the enclosure. Visible laser radiation when open. DO NOT STARE INTO BEAM.

CAUTION: The apparatus shall not be exposed to water, dripping or splashing and that no objects filled with liquids, such as vases, shall be placed on the apparatus.

CAUTION concerning the Power Cord

Most appliances recommend they be placed upon a dedicated circuit;

That is, a single outlet circuit which powers only that appliance and has no additional outlets or branch circuits. Check the specification page of this owner's manual to be certain.

Do not overload wall outlets. Overloaded wall outlets, loose or damaged wall outlets, extension cords, frayed power cords, or damaged or cracked wire insulation are dangerous. Any of these conditions could result in electric shock or fire.

Periodically examine the cord of your appliance, and if its appearance indicates damage or deterioration, unplug it, discontinue use of the appliance, and have the cord replaced with an exact replacement part by an authorized servicer.

Protect the power cord from physical or mechanical abuse, such as being twisted, kinked, pinched, closed in a door, or walked upon. Pay particular attention to plugs, wall outlets, and the point where the cord exits the appliance.



Disposal of your old appliance

1. When this crossed-out wheeled bin symbol is attached to a product it means the product is covered by the European Directive 2002/96/EC.
2. All electrical and electronic products should be disposed of separately from the municipal waste stream via designated collection facilities appointed by the government or the local authorities.
3. The correct disposal of your old appliance will help prevent potential negative consequences for the environment and human health.
4. For more detailed information about disposal of your old appliance, please contact your city office, waste disposal service or the shop where you purchased the product.





INTRODUCTION

Safety Precautions	2
Table of Contents	3
Before Use	3
Front Panel/ Rear Panel	4
Remote Control	5

PREPARATION

Connections	6-8
Before Operation	9-15

OPERATION

Operation with DVD and Video CD	16-18
Operation with Audio CD and MP3/WMA Disc	19
Operation with JPEG Disc	20
Programmed Playback	21
Operation with DivX Disc	22
Operation with RADIO	23
Operation with TAPE	24
Operation with KARAOKE	25-29

REFERENCE

Troubleshooting	30
Language Code List/Country Code List	31
Specifications	



About Symbols

About the symbol display



“” may appear on the TV screen during operation. This icon means the function explained in this owner’s manual is not available on that specific DVD video disc.

About the disc symbols for instructions

A section whose title has one of the following symbol is applicable only to the disc represented by the symbol.



-  DVD
-  Video CDs
-  Audio CDs
-  MP3 disc
-  WMA disc
-  JPEG disc
-  DivX disc

About the symbols for instructions

-  Indicates hazards likely to cause harm to the unit itself or other material damage.
-  Indicates special operating features of this unit.
-  Indicates tips and hints for making the task easier.



Playable Discs

	DVD (8 cm / 12 cm disc)
	Video CD (VCD) (8 cm / 12 cm disc)
	Audio CD (8 cm / 12 cm disc)

In addition, this unit can play a DVD±R, DVD±RW, SVCD, and CD-R or CD-RW that contains audio titles, MP3, WMA, JPEG or DivX files.

Notes

- Depending on the conditions of the recording equipment or the CD-R/RW (or DVD±R/RW) disc itself, some CD-R/RW (or DVD±R/RW) discs cannot be played on the unit.
- Do not attach any seal or label to either side (the labeled side or the recorded side) of a disc.
- Do not use irregularly shaped CDs (e.g., heart-shaped or octagonal). It may result in malfunctions.

Notes on DVDs and Video CDs

Some playback operations of DVDs and Video CDs may be intentionally fixed by software manufacturers. As this unit plays DVDs and Video CDs according to disc content designed by the software manufacturer, some playback features of the unit may not be available or other functions may be added.

Refer also to the instructions supplied with the DVDs and Video CDs. Some DVDs made for business purposes may not be played on the unit.

Regional code of the DVD player and DVDs

Your system has a region code printed on the back of the unit and will only play DVDs labelled with the same region code.

DVDs labelled  will also play on this system. If you try to play any other DVD, the message “Check Regional Code” will appear on the TV screen. Depending on the DVD, no region code indication may be labelled even though playing the DVD is prohibited by area restrictions.

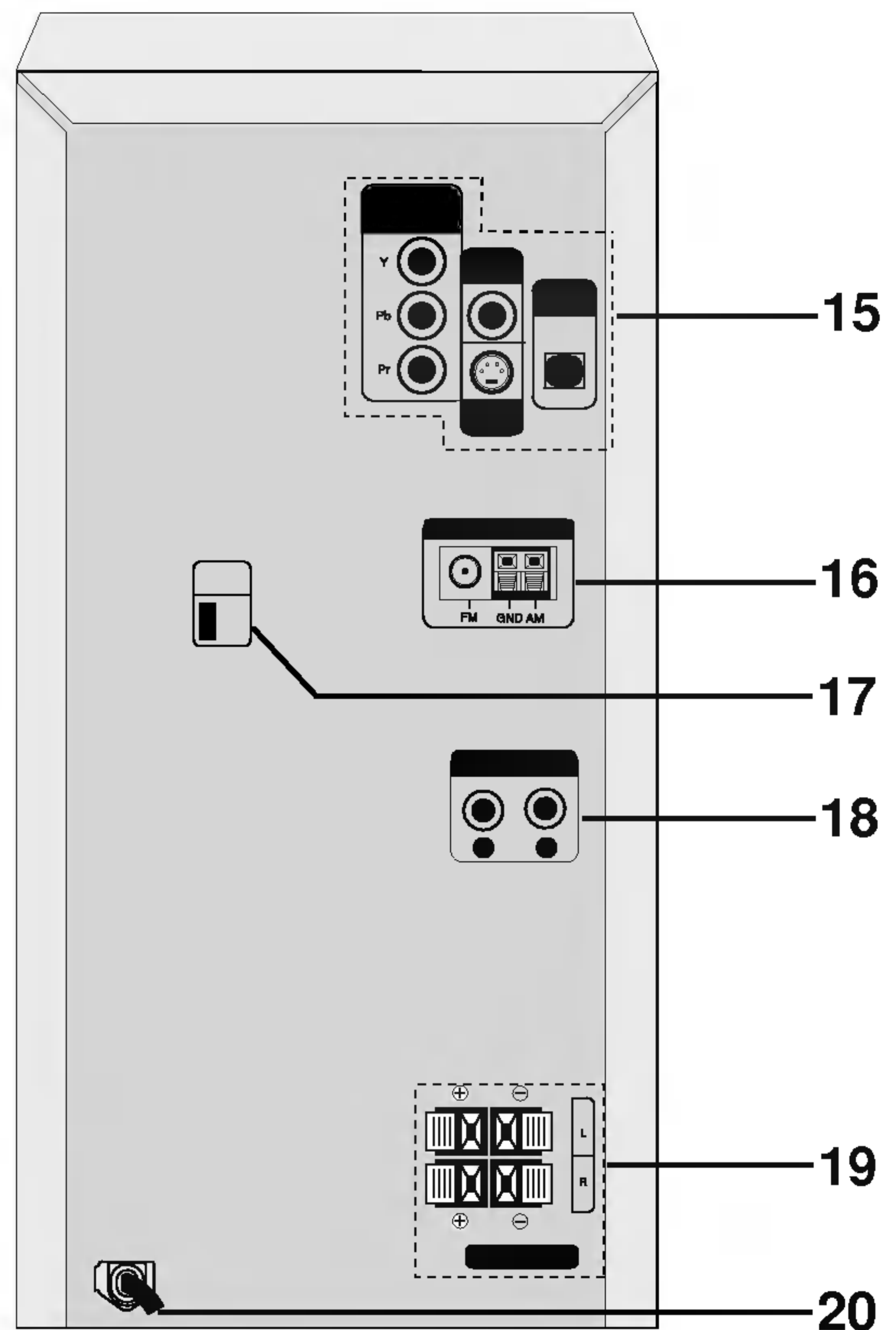
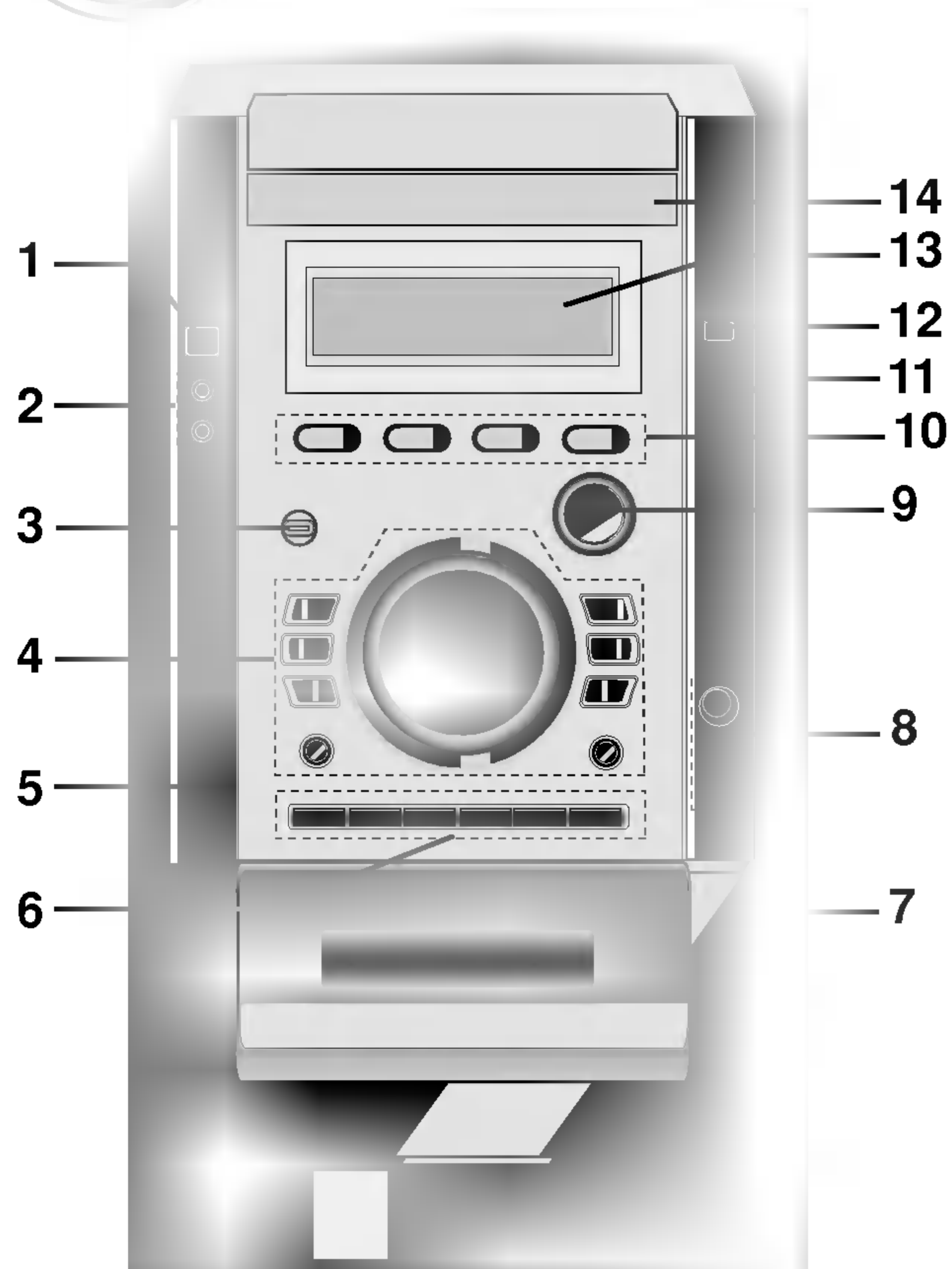

1. POWER (⏻ STANDBY/ON) button
2. • CLOCK button
• TIMER button
3. XDSS button
4. • VOLUME knob
• PRESET (-/+) buttons
• TAPE REVERSE PLAY (◀) button
• PLAY (▶) button
• CD SEARCH (◀◀/▶▶), TAPE REWIND/
FAST FORWARD (◀◀/▶▶) buttons
• TUNING (-/+) buttons, TEMPO (-/+) buttons
• CD PAUSE (||)/STEP button
• STOP (■)/CLEAR button
• OAO button
• RECORD/ RECORD PAUSE (●REC/||) button
5. HEADPHONE SOCKET (🎧 PHONES) -∅3.5mm
6. • EQUALIZER (EQ) button
• PLAY MODE button
• SET/COUNT. RESET button
• CD SYNCHRO RECORDING (CD SYNC.) button
• MODE/RIF button
• PROGRAM/MEMORY button

7. ▲ PUSH EJECT position
8. • MIC VOLUME KNOB (MIC VOL.) : OPTIONAL
• MIC JACKS (MIC) : OPTIONAL
9. MULTI JOG DIAL
• MANUAL TUNING
• CD SKIP (◀◀/▶▶)
• CLOCK ADJUST
• KEY CONTROL (b/#)
10. FUNCTION SELECT buttons
(TUNER/BAND, DVD/CD/KARAOKE, TAPE, AUX)
11. REMOTE SENSOR
12. OPEN/CLOSE (▲) button
13. DISPLAY WINDOW
14. CD TRAY
15. • COMPONENT VIDEO OUT/ PROGRESSIVE
SCAN (Y Pb Pr) Connectors
• MONITOR OUT Connector
• S-VIDEO OUT Connector
• OPTICAL OUT Connector
16. FM/AM ANTENNA Connector
17. VOLTAGE SELECTOR : OPTIONAL
18. AUX INPUT (L/R)
19. SPEAKER Connector
20. POWER CORD



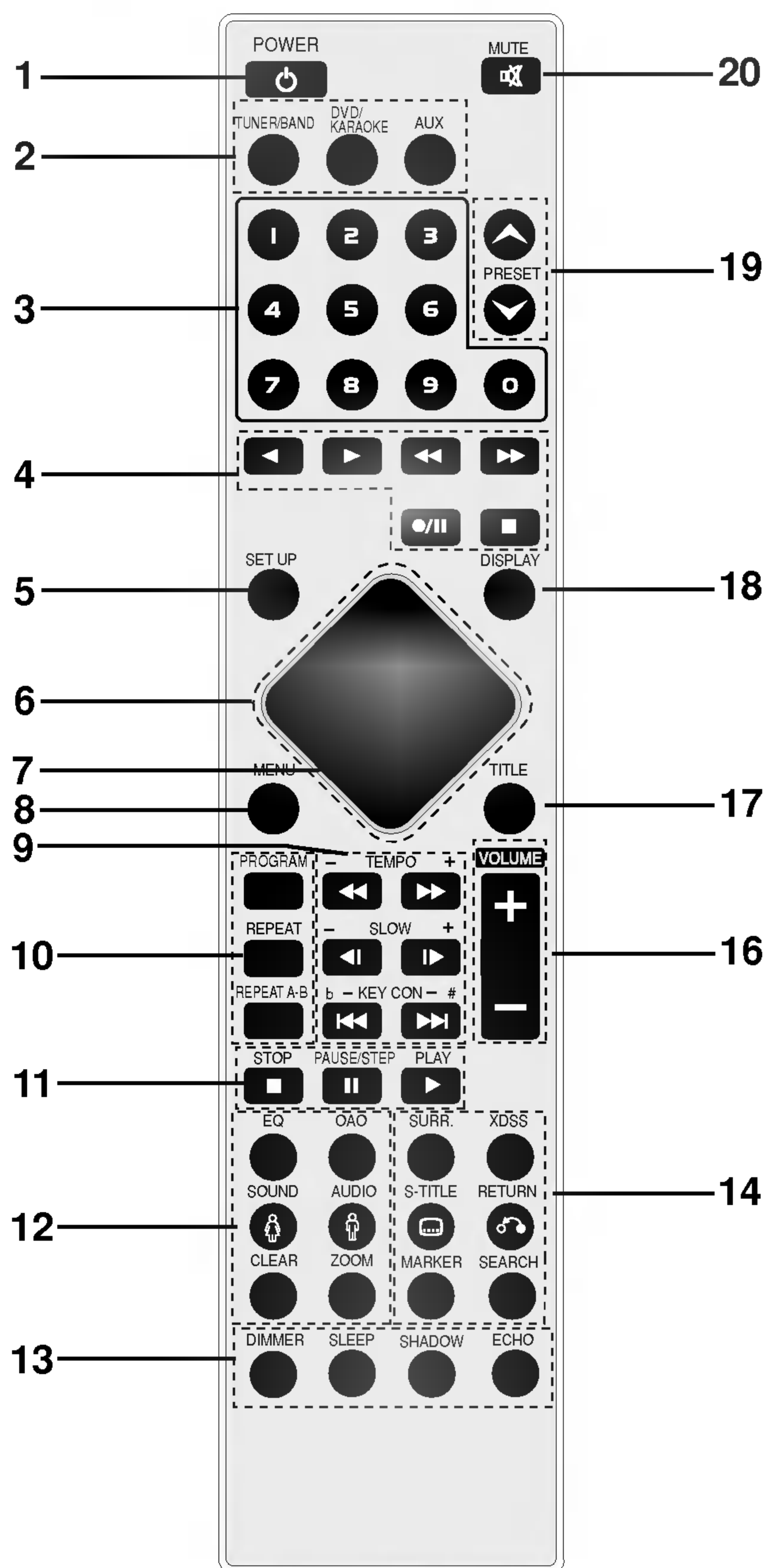

1. POWER button
2. FUNCTION SELECT buttons (TUNER/BAND, DVD/KARAOKE, AUX)
3. NUMERIC buttons (0-9)
4. TAPE FUNCTION buttons
 - REVERSE PLAY (◀: optional)
 - PLAY (▶)
 - REWIND/ FAST FORWARD PLAY (◀◀/▶▶)
 - RECORD/ RECORD PAUSE (●/||)
 - TAPE STOP (■)
5. SET UP button
6. ARROW buttons (For use in highlighting a selection on a GUI menu screen, TITLE and MENU screen.)
7. SELECT/ENTER button
8. MENU button (Use the MENU button to display the menu screen included on DVD video discs.)
9. SCAN (◀◀/▶▶)/ TEMPO (-/+)/ SLOW (◀||/||▶)/ KEY CONTROL (b/#)/ SKIP (◀◀/▶▶) buttons
10. PROGRAM/ REPEAT/ REPEAT A-B buttons
11. STOP (■), PAUSE/STEP, PLAY (▶) buttons
12. EQUALIZER (EQ)/ OAO/ SOUND/ FEMALE(♀) AUDIO/ MALE(♂) / CLEAR / ZOOM buttons
13. DIMMER/ SLEEP/ SHADOW/ ECHO buttons
14. SURROUND (Surr.)/ XDSS/ SUBTITLE (S-TITLE) RETURN / MARKER/ SEARCH buttons
15. VOLUME +/- buttons
16. VOLUME +/- buttons
17. TITLE button (Use the TITLE button to display the title screen included on DVD video discs.)
18. DISPLAY button
19. PRESET (▼/▲) buttons
20. MUTE button

Remote Control Operation Range

Point the remote control at the remote sensor and press the buttons.

- **Distance:** About 23 ft (7 m) from the front of the remote sensor
- **Angle:** About 30° in each direction of the front of the remote sensor

Remote control battery installation

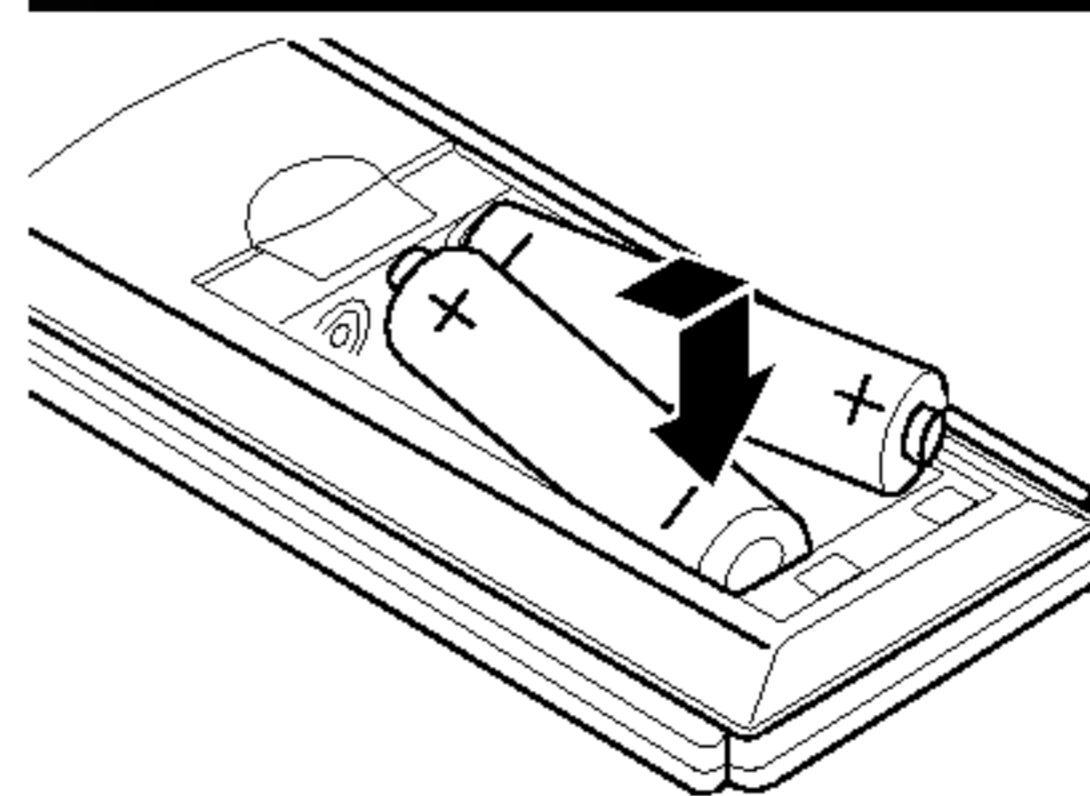

Detach the battery cover on the rear of the remote control, and insert two R03 (size AAA) batteries with + and - aligned correctly.

⚠ Caution

Do not mix old and new batteries. Never mix different types of batteries (standard, alkaline, etc.).



Connecting to a TV

- Make one of the following connections, depending on the capabilities of your existing equipment.

Tips

- Depending on your TV and other equipment you wish to connect, there are various ways you could connect the unit. Use one of the connections described below.
- Please refer to the manuals of your TV, VCR, Stereo System or other devices as necessary to make the best connections.

Caution

- Make sure the unit is connected directly to the TV. Select the correct AV input on your TV.
- Do not connect your unit to TV via your VCR. The DVD image could be distorted by the copy protection system.

Video connection

Connect the MONITOR OUT jack from the unit to the VIDEO IN jack on the TV using the video cable supplied (V).

S-Video connection

Connect the S-VIDEO OUT jack on the unit to the S-VIDEO IN jack on the TV using the S-Video cable (S).

Component Video (Color Stream®) connection

Connect the COMPONENT VIDEO OUT/ PROGRESSIVE SCAN jacks from the unit to the corresponding in jacks on the TV using an Y Pb Pr cable (C).

Progressive Scan (ColorStream® pro) connection

- If your television is a high-definition or “digital ready” television, you may take advantage of the unit’s progressive scan output for the highest video resolution possible.
- If your TV does not accept the Progressive Scan format, the picture will appear scrambled if you try Progressive Scan on the unit.

Connect the COMPONENT VIDEO/ PROGRESSIVE SCAN jacks from the unit to the corresponding in jacks on the TV using an optional Y Pb Pr cable (C).

Note

- Set the Progressive to “On” on the Setup menu for progressive signal, see page 13.

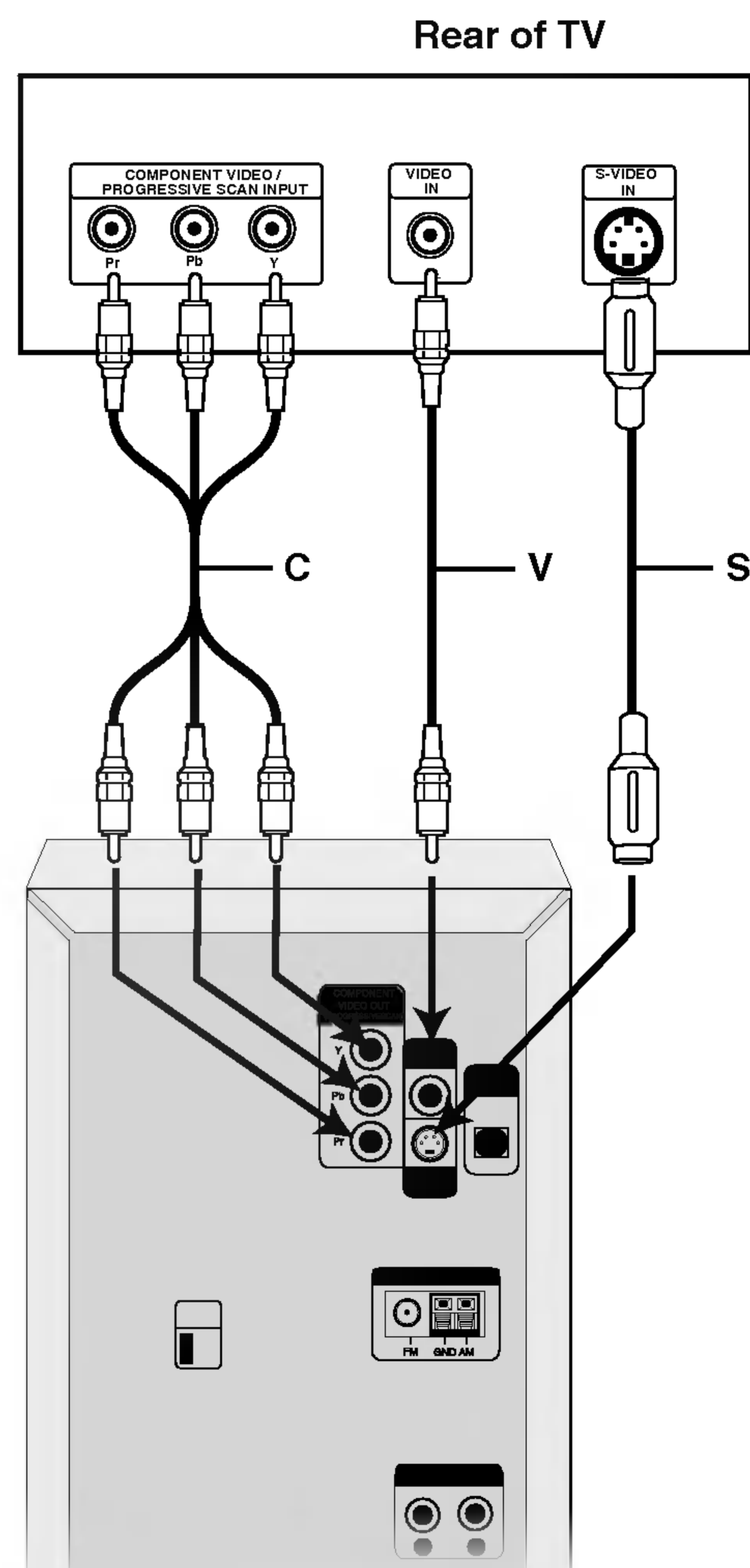



Connecting to Antenna

Connect the supplied FM/AM antennas for listening to the radio.

- Connect the AM loop antenna to the AM antenna connector.
- Connect the FM wire antenna to the FM antenna connector.

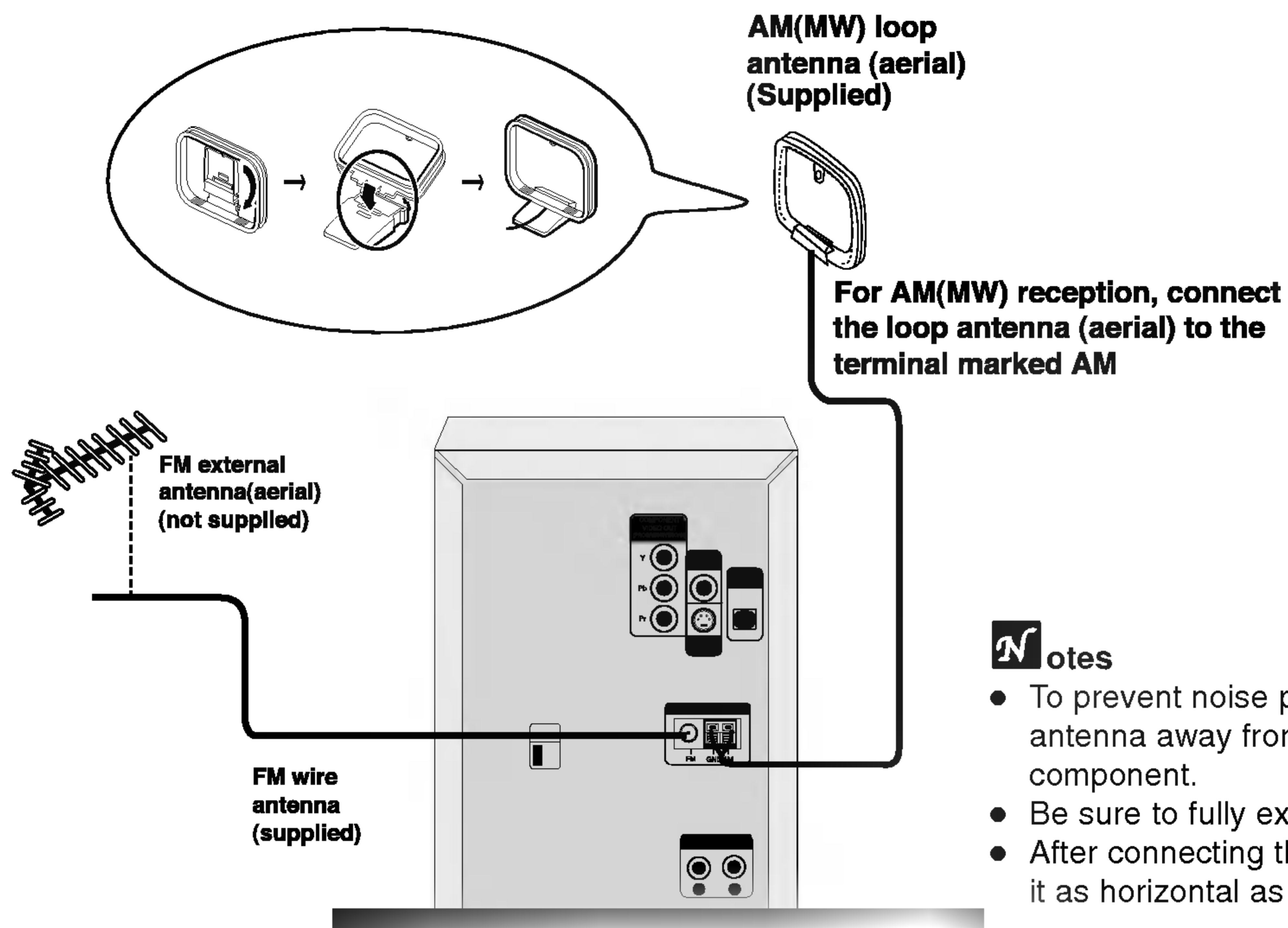

Speaker System Connection

Connect the speaker cords to the speaker connector.

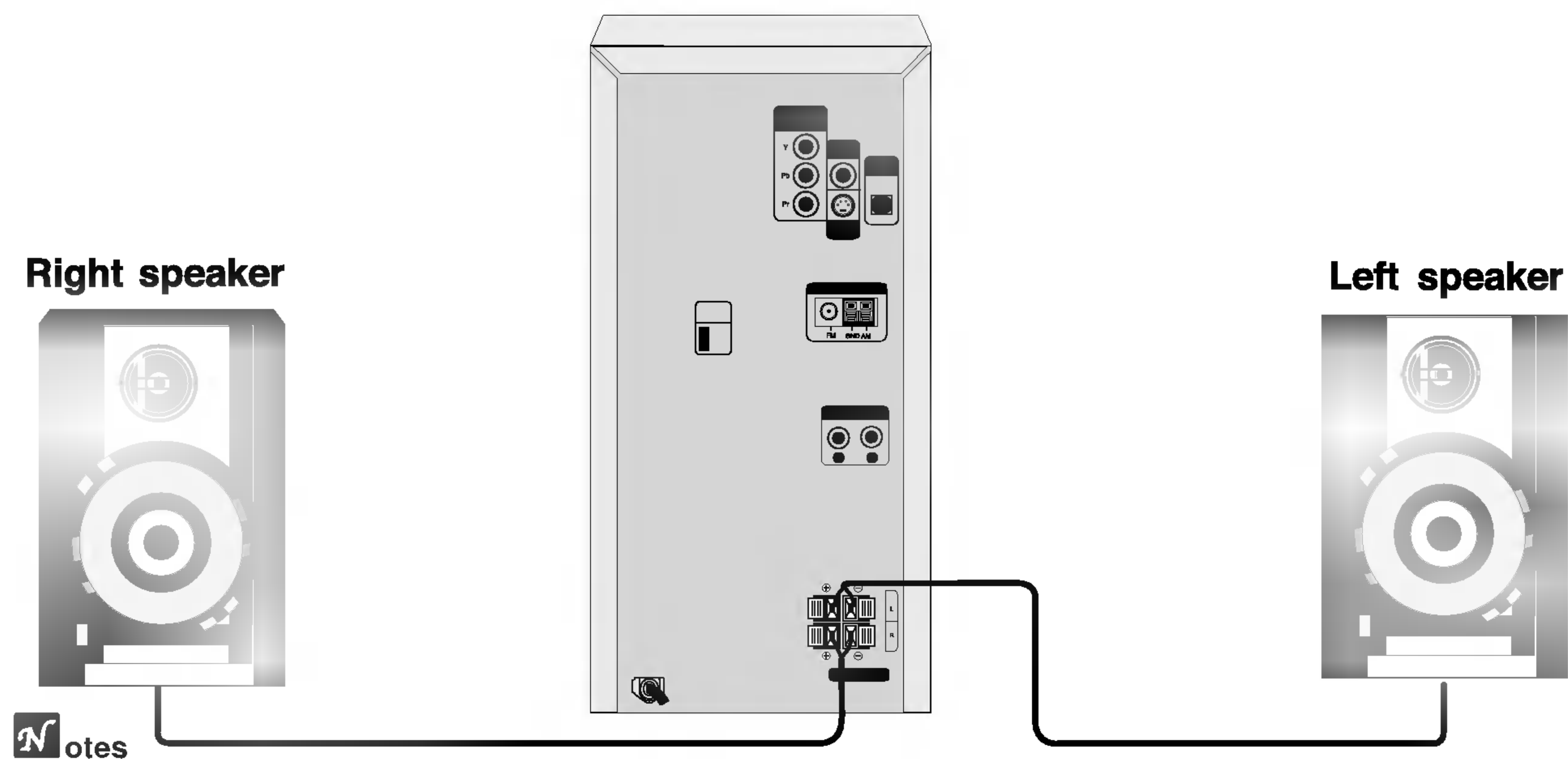



Connecting to Auxiliary Equipment

You can use VCR or other unit connected to the AUX connector.

- 1** Connect a VCR or auxiliary device, etc to the AUX connector.
- 2** Select AUX function pressing the AUX button on the unit or the remote control.

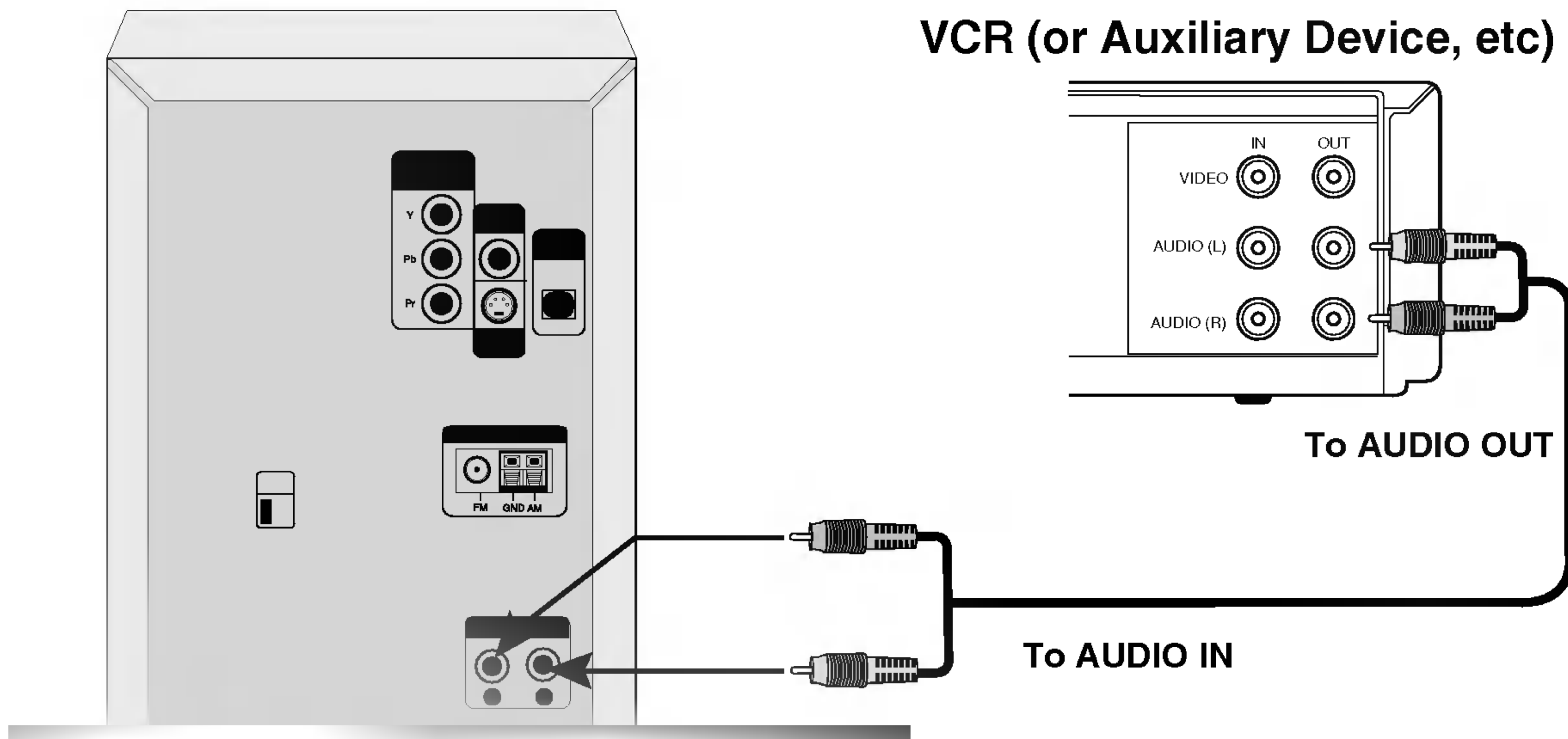

Connecting to Optional Equipment

Connecting to an amplifier equipped with two channel digital stereo (PCM) or to an Audio/ Video receiver equipped with a multi-channel decoder (Dolby Digital™ or MPEG 2)

Connect the OPTICAL OUT connector of this unit to the corresponding in jack on your Amplifier or Receiver.

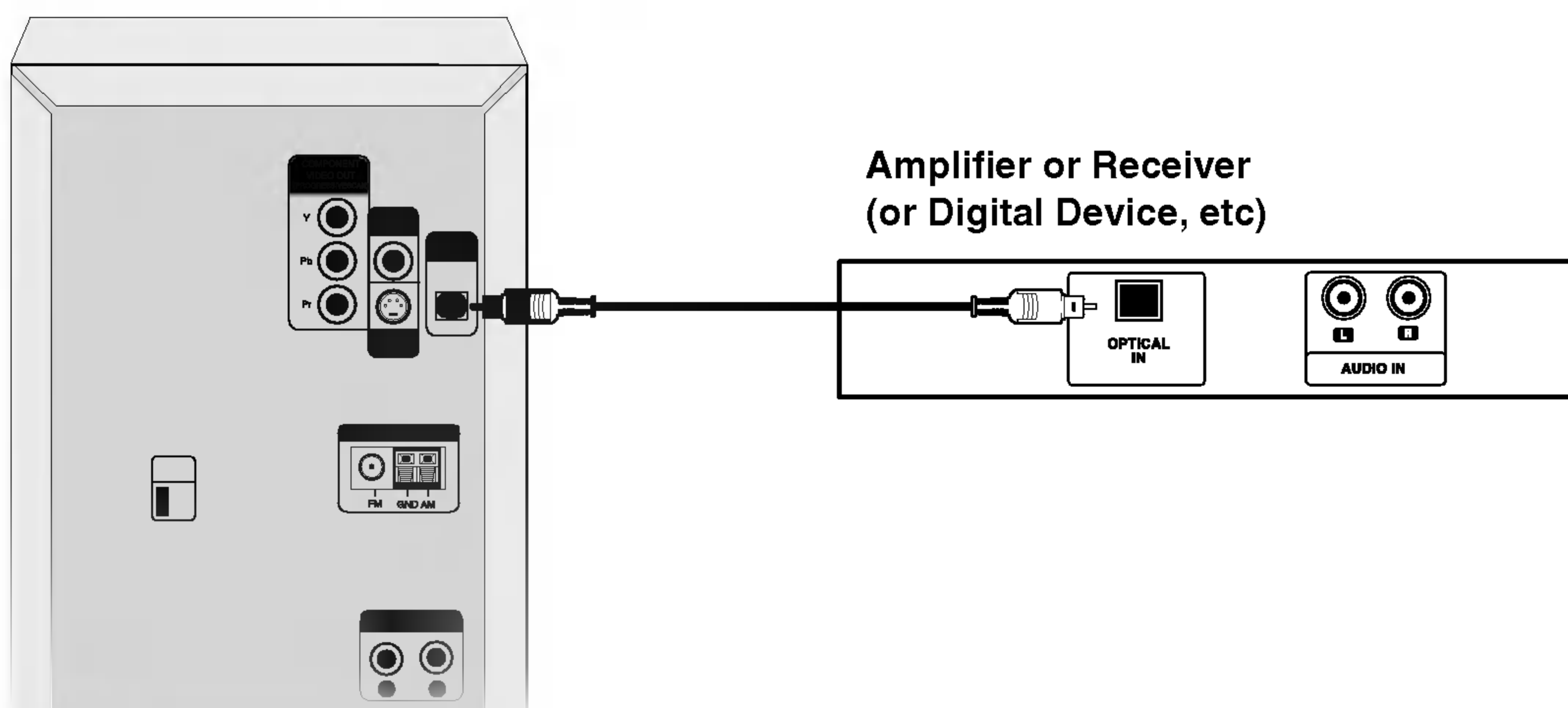

Note

If the audio format of the digital output does not match the capabilities of your unit, the receiver will produce a strong, distorted sound or no sound at all.



Volume Adjustment

- Turn VOLUME knob clockwise to increase the sound level, or counterclockwise to decrease it.
- Use VOLUME + to increase the sound level, or use VOLUME - to decrease it on the remote control.

MUTE

Press MUTE to turn off the sound, press again to restore.

You can mute your unit in order, for example, to answer the telephone,  flashes in the display window.

Sound Quality Adjustment

• To activate stereo sound

You can choose between 4 fixed sound impressions. Select a desired sound mode using the EQUALIZER (EQ).

FLAT	: Linear frequency response
ROCK	: More bass, more treble
POP	: Less bass, less treble
CLASSIC	: For orchestral music

• Headphone Jack

Connect a stereo headphone plug ($\phi 3.5\text{mm}$) into the headphone jack.

The speakers are automatically disconnected when you plug in the headphones (not supplied).

SURROUND

To activate surround mode

Press SURROUND (SURR.) to reinforce surround effect.

SURROUND ON \leftrightarrow SURROUND OFF

XDSS (Extreme Dynamic Sound System)

Press XDSS to reinforce treble and bass.

- The "XDSS ON" indicator lights up.

To cancel it press XDSS again.

- The "XDSS OFF" indicator lights up.

OAO (Orientation Acoustic Optimizer) ON/OFF

Press OAO to reinforce the bass sound.

The "OAO ON" or "OAO OFF" indicator lights. To cancel, press OAO again.

DIMMER

This function is darken the display window by half in power-on status. Press DIMMER on the remote control. To cancel it press the button again.

Setting the Clock

1 Press CLOCK.
(If the clock requires setting, press and hold CLOCK for more than 2 seconds.)
- The hours display begins to blink.

2 Select either the 12 hour cycle or the 24 hour cycle by turning MULTI JOG DIAL.

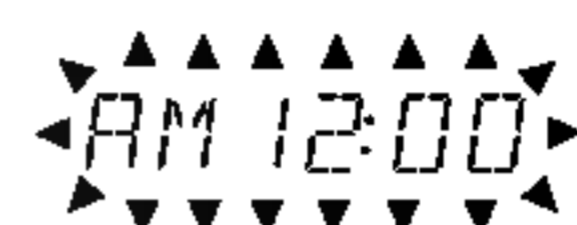

(12HR)

or



(24HR)

3 Press SET to confirm the selected hour cycle.

4 Use MULTI JOG DIAL to set the current hour.

5 Press SET.

6 Use MULTI JOG DIAL to set current minutes.

7 Press SET and the correct time is shown on the display.

8 Press CLOCK at any time to show the time on the display, for about 5 seconds.

Sleep Timer Function

When the sleep timer is set, the unit automatically turns off after the specified time has elapsed.

1 To specify the time delay before the power is turned off, press SLEEP.

In the display window you can see *SLEEP 180* for about 5 seconds. This means that the system turns off automatically after 180 minutes.

2 Each time you press SLEEP the setting changes in the following order.

SLEEP 180 \rightarrow 150 \rightarrow 120 \rightarrow 90 \rightarrow 80 \rightarrow 70 \rightarrow 60 \rightarrow 50 \rightarrow 40 \rightarrow 30 \rightarrow 20 \rightarrow 10 \rightarrow OFF \rightarrow SLEEP 180...

3 To check the remaining time until the power is turned off.

While the sleep function is active press SLEEP briefly. The time remaining until the unit turns off is displayed for about 5 seconds.

Note

If you press SLEEP while the sleep time is displayed, the SLEEP time is reset.

To cancel Sleep Timer setting

If you wish to stop the function, press the SLEEP button repeatedly until "SLEEP 10" appears, and then press SLEEP once again after "SLEEP 10" shows on the display window.



Timer Function

With the TIMER function you can have the radio reception and recording, CD or tape playing turned on and off at the time desired.

1 Press **CLOCK** to check the current time.

For your reference

If you don't set clock, timer function doesn't work.

2 Press **TIMER** to enter the timer setting mode. TUNER-CD-TAPE flash in the display window in turn.

For your reference

If you want to correct the previous memorized TIMER setting, press and hold the TIMER button more than 2 seconds.

- The previous memorized timer setting for on Time and "⊖" indicators appear in the display.

3 Press **SET** when the desired function flashes.

4 1. a. When you select TUNER function, 'PLAY' and 'REC' indicator flash in the display window alternately for about 3 seconds.

'PLAY' indicator : TUNER play only

'REC' indicator : TUNER play and recording

b. Press **SET** when the desired function flashes.

c. Select the previous memorized preset number with **MULTI JOG DIAL** on the front panel and press **SET**.

'ON TIME' indicator appears for about 0.5 seconds in the display window and then disappears.

2. When you select **CD** or **TAPE** function, 'ON TIME' indicator appears for about 0.5 seconds in the display window and then disappears.

5 Set the turn on hour by turning **MULTI JOG DIAL**.

6 Press **SET** to confirm the turn on hour time.

7 Set the turn on minutes time turning **MULTI JOG DIAL**.

8 Press **SET** to confirm the turn on minutes time.

'OFF TIME' indicator appears for about 0.5 seconds in the display window and then disappears.

9 Set the turn off hour time turning **MULTI JOG DIAL**.

10 Press **SET**.

11 Set the turn off minutes turning **MULTI JOG DIAL**.

12 Press **SET**.

13 Adjust the volume level turning **MULTI JOG DIAL**.

14 Press **SET**.

"⊖" appear in the display window and the timer setting has been completed.

15 Turn the system off.

The selected timer functions are automatically switched on and off at the preset times.

To cancel or check the timer

Each time the **TIMER** button is pressed you can select the timer set or cancel. You can also check the timer setting status.

To activate or check the timer, press the **TIMER** button repeatedly so that "⊖" appears in the display window.

To cancel the **TIMER**, press the **TIMER** button repeatedly so that "⊖" disappears from the display window.

Note

If the disc is inserted the DVD, VCD or MP3 except audio CD on the unit, the timer function plays to the TUNER.



Using Microphone (OPTIONAL)

You can sing to a music source by connecting a microphone to the unit.

- 1** Connect your microphone to the MIC socket.
“ECHO-OFF” will be shown in the display window.
- 2** Play a music you want.
- 3** Sing along with the accompaniment.
Adjust the microphone volume by turning MIC VOLUME KNOB.

For your reference

You can record during using microphone.
Refer to the “Recording” explanation section.
(See page 24.)

Notes

- When not using the microphone, set the MIC volume knob to minimum or turn off the MIC and remove the microphone from the MIC socket.
- If the microphone is set too near the speaker, a howling sound may be produced. In this case, move the microphone away from the speaker or decrease the sound level by using the MIC volume control.
- If sound through the microphone is extremely loud, it may be distorted. In this case, turn the MIC volume control toward minimum.

To Adjust ECHO Volume

You can give an echo effect to the sound from the microphones.

Press the ECHO repeatedly.

ECHO - OFF → ECHO - 1 → ECHO - 2



Mini Glossary for Audio Stream & Surround mode

DIGITAL

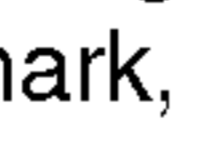
The Dolby Digital surround format lets you enjoy up to 5.1 channels of digital surround sound from a Dolby Digital program source. If you play DVDs with “” mark, you can enjoy even better sound quality, greater spatial accuracy, and improved dynamic range.

Manufactured under license from Dolby Laboratories. “Dolby”, “Pro Logic” and double-D symbol are trademarks of Dolby Laboratories.

BYPASS

Outputs the sound from the front left and right speakers and subwoofer.

Sound Mode

You can enjoy surround sound simply by selecting one of the pre-programmed sound fields according to the program you want to listen to.

When DVD is inserted

You can change the Digital Audio Output mode by pressing the **AUDIO** button on the remote control during playback.

Each time you press SOUND button, the “BYPASS” indicator will only be shown on the display window.

When Video CD is inserted

Each time you press SOUND button, the sound mode of Video CD is changed on the display window as the following order.

BYPASS → STUDIO → CLUB → HALL → THEATER 1 → CHURCH → BYPASS...

Note



After you select the “Bypass” of sound mode by pressing SOUND button, press AUDIO button. The Left, Right and Stereo of audio channel will be displayed on the TV screen.

When CD is inserted

Each time you press SOUND button, the sound mode of Audio CD is changed on the display window as the following order.

BYPASS → STUDIO → CLUB → HALL → THEATER 1 → CHURCH → BYPASS...

For your reference

- Initial sound of DVD function is BYPASS.
- You can identify the encoding format of program software by looking at its packaging.
 - Dolby Digital discs are labelled with the  logo.
 - Dolby Surround encoded programs are labelled with the  logo.

Note

When you play sound tracks with 96kHz sampling frequency, the output signals will be converted to 48kHz (sampling frequency).



Caution:

Before using the remote control, press the **DVD/CD/KARAOKE** button to select the device to be operated.



Press ◀ or ▶ to change the setting of an item.

The number buttons can be also be used for setting numbers (e.g., title number). For some functions, press SELECT/ENTER to execute the setting.

General Explanation

This manual gives basic instructions for operating the unit. Some DVDs require specific operation or allow only limited operation during playback.

When this occurs, the symbol  appears on the TV screen, indicating that the operation is not permitted by the unit or is not available on the disc.

On-Screen Display

General playback status can be displayed on the TV screen. Some items can be changed on the menu.

On-screen display operation







Press **DISPLAY** during playback.



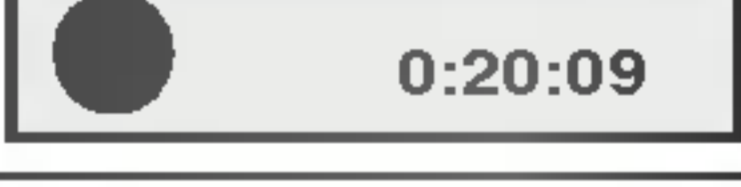
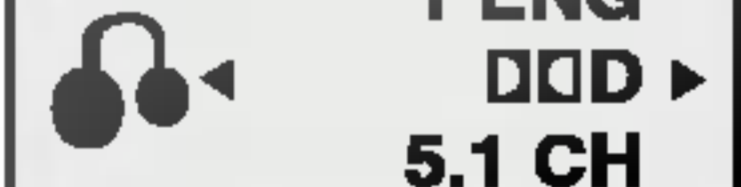
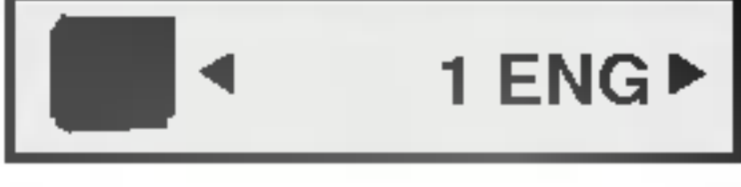

Press **▲ / ▼** to select an item.

The selected item will be highlighted.

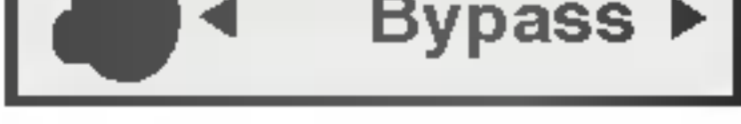
Example: On-Screen Display during playing DVD

Items	Function / Action using ▲ / ▼ to select item	Selection Method
Title Number	 Shows the current title number and total number of titles / skips to the desired title number.	◀/▶, Numbers, or SELECT/ENTER
Chapter Number	 Shows the current chapter number and total number of chapters / skips to the desired chapter number.	◀/▶, Numbers, or SELECT/ENTER
Time search	 Shows the elapsed playing time / searches by elapsed time.	Numbers, SELECT/ENTER
Audio language and Digital Audio Output mode	 Shows the current audio soundtrack language, encoding method, and channel number / changes the setting.	◀/▶ or AUDIO
Subtitle language	 Shows the current subtitle language / changes the setting.	◀/▶ or SUBTITLE
Angle	 Shows the current angle number and total number of angles / changes the angle.	◀/▶
Sound	 Shows the current sound mode / changes the setting.	◀/▶ or SOUND

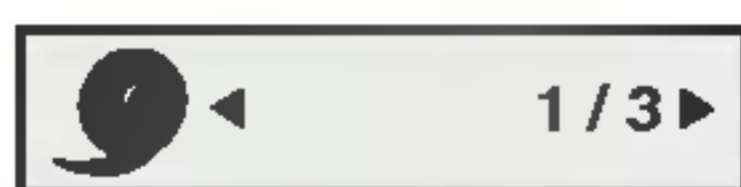
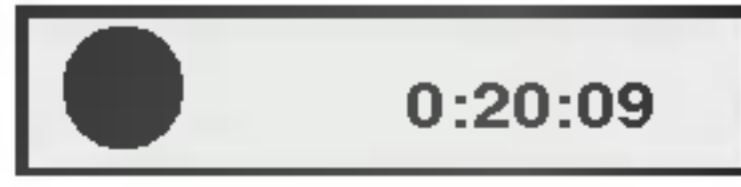
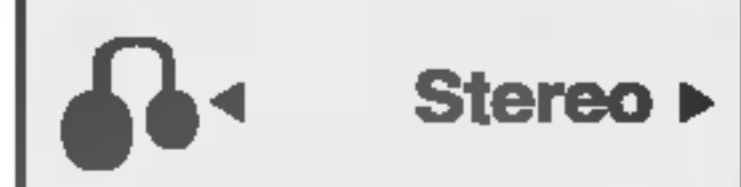
Example: On-Screen Display during playing VCD

Items	Function / Action using ▲ / ▼ to select item	Selection Method
Track Number	 Shows the current track number, total number of tracks and PBC On mode / skips to the desired track number.	◀/▶, Numbers, or SELECT/ENTER
Time	 Shows the elapsed playing time.	◀/▶, Numbers, or SELECT/ENTER
Audio Channel	 Shows the audio channel / changes the audio channel.	◀/▶ or AUDIO
Sound	 Shows the current sound mode / changes the setting.	◀/▶ or SOUND

Temporary Feedback Field Icons



Repeat title



Repeat sequence



Resume play from this point



Action prohibited or not available



Notes

- Some discs may not provide all of the features on the on-screen display example shown below.
- If no button is pressed for 10 seconds, the on-screen display disappears.



Initial Settings

By using the Setup menu, you can make various adjustments to items such as picture and sound. You can also set a language for the subtitles and the Setup menu, among other things. For details on each Setup menu item, see pages 13 to 15.

To display and exit the Menu:

Press SETUP to display the menu. A second press of SETUP will take you back to initial screen.

To go to the next level:

Press **▶** on the remote control.

To go back to the previous level:

Press **◀** on the remote control.

General Operation

- 1 Press SETUP.**
The setup menu appears.
- 2 Use ▲ / ▼ to select the desired option then press ▶ to move to the second level.**
The screen will be shown the current setting for the selected item, as well as alternate setting(s).
- 3 Use ▲ / ▼ to select the second desired option then press ▶ to move to the third level.**
- 4 Use ▲ / ▼ to select the desired setting then press SELECT/ENTER to confirm your selection.**
Some items require additional steps.
- 5 Press SETUP or PLAY to exit the setup menu.**

LANGUAGE

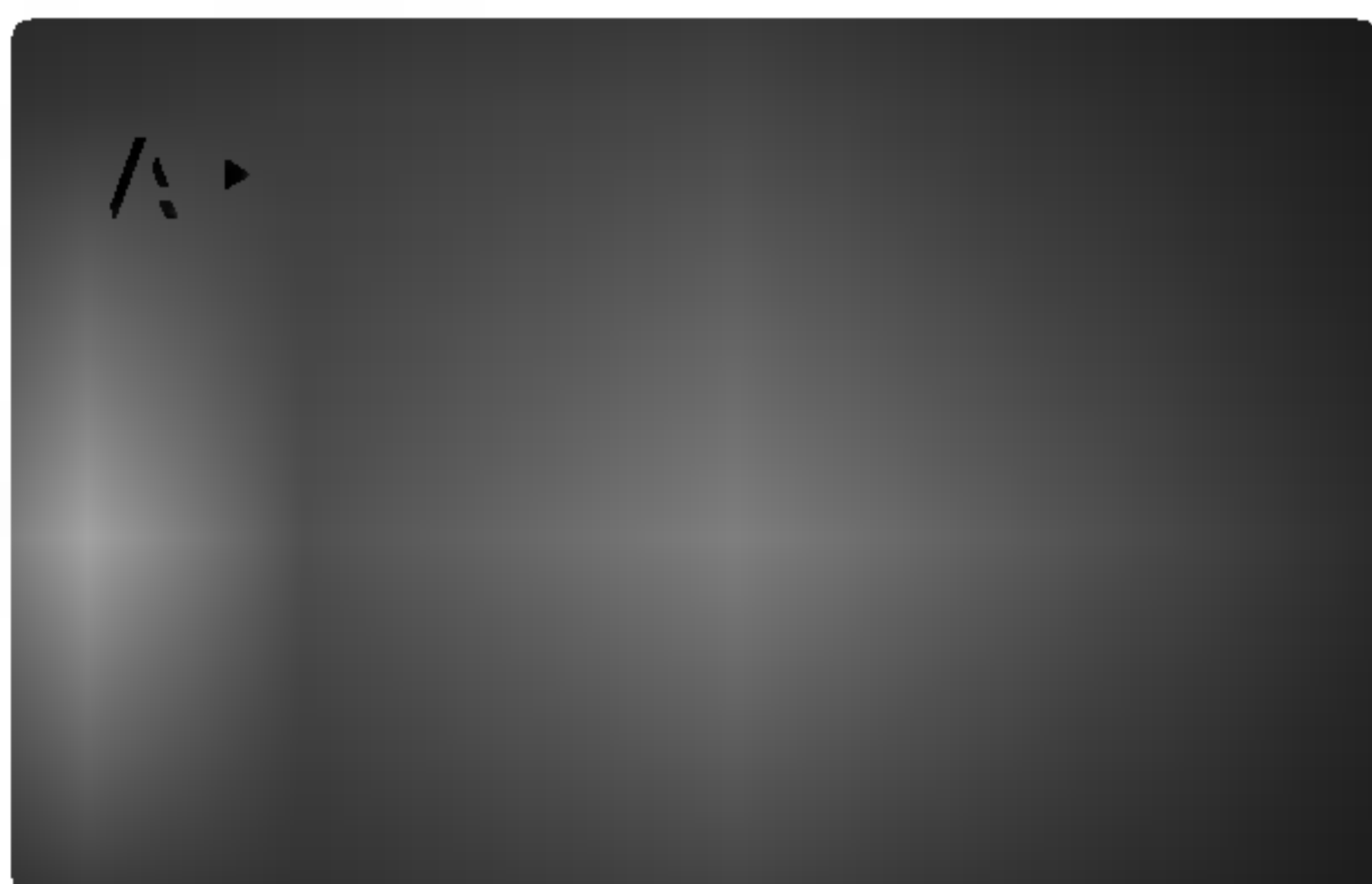

OSD

Select a language for the Setup menu and on-screen display.

Disc Audio / Subtitle / Menu

Select the language you prefer for the audio track (disc audio), subtitles, and the disc menu.

Original: Refers to the original language in which the disc was recorded.

Other: To select another language, press number buttons to enter the corresponding 4-digit number according to the language code list on page 31. If you enter the wrong language code, press CLEAR on the remote control.

DISPLAY

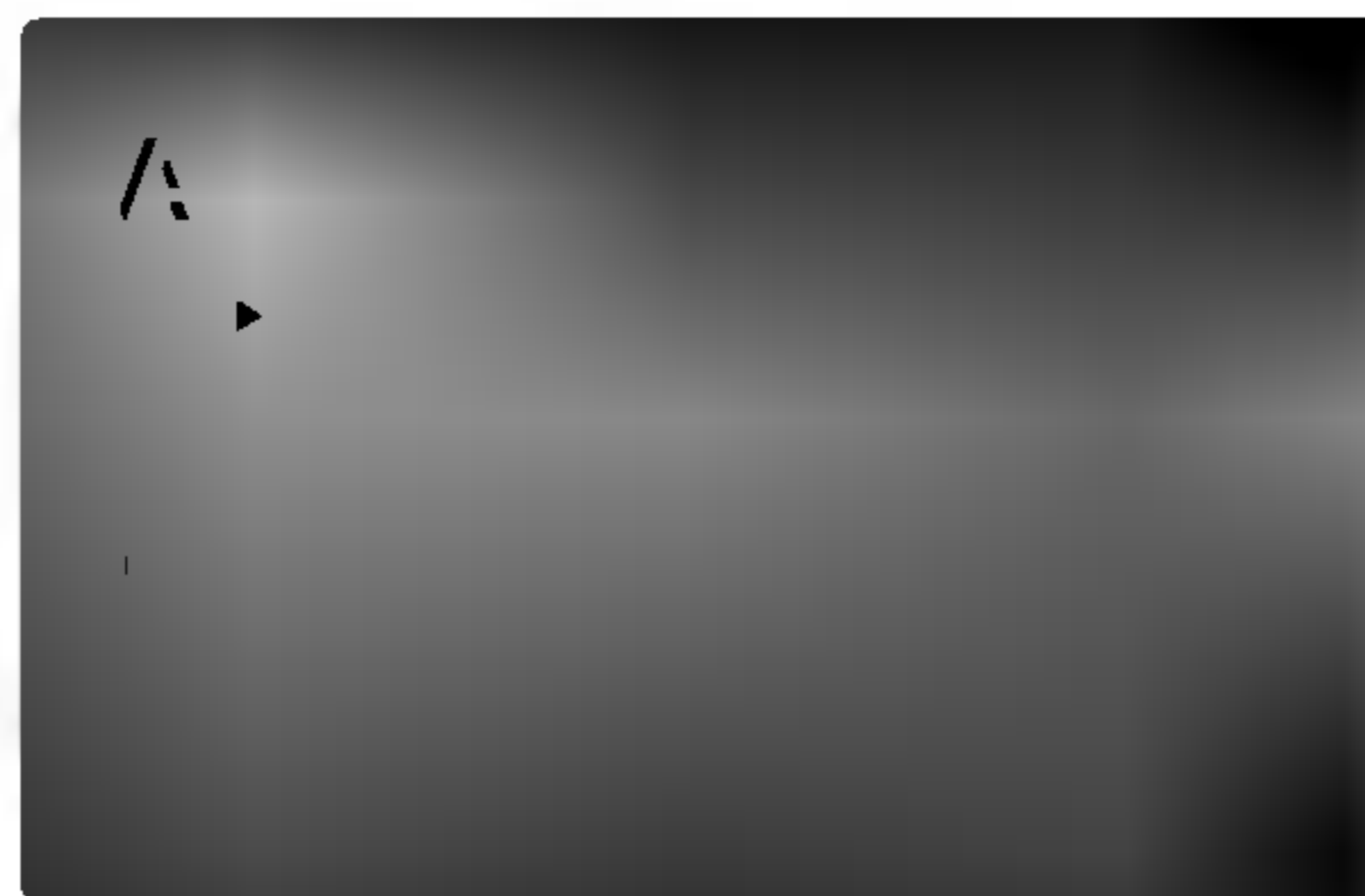

TV Aspect

4:3: Select when a standard 4:3 TV is connected.
16:9: Select when a 16:9 wide TV is connected.

Display Mode

Display Mode setting works only when the TV Aspect mode is set to "4:3".

Letterbox: Displays a wide picture with bands on the upper and lower portions of the screen.

Panscan: Automatically displays the wide picture on the entire screen and cuts off the portions that do not fit.

Progressive Scan

Progressive Scan Video provides the highest quality pictures with less flickering.
If you are using the Component Video jacks for connection to a TV or monitor that is compatible with a progressive scan signal, set Progressive Scan to On.

To Turn ON progressive scan:

Connect component out of the DVD to the input of your monitor/television, set your television or monitor to Component Input.

- Select "Progressive Scan" on the DISPLAY menu then press **▶**.
- Select "On" using the **▲ / ▼** buttons.
- Press SELECT/ENTER to confirm your selection. The confirm menu will appear.
- When the confirm menu appears on your screen Cancel is highlighted as default. Use the **◀ / ▶** buttons to highlight "Enter".
- Pressing Enter will set the player to Progressive scan mode.

⚠ Caution

Once the setting for progressive scan output is entered, an image will only be visible on a progressive scan compatible TV or monitor. If you set Progressive Scan to On in error, you must reset the unit.

- Remove any disc from the unit and close the disc tray. See that "NO DISC" is displayed on the display window
- Press and hold STOP (■) for five seconds then release it. The video output will be restored to the standard setting, and a picture will once again be visible on a conventional analog TV or monitor.



AUDIO

Each DVD disc has a variety of audio output options. Set the player's AUDIO options according to the type of audio system you use.

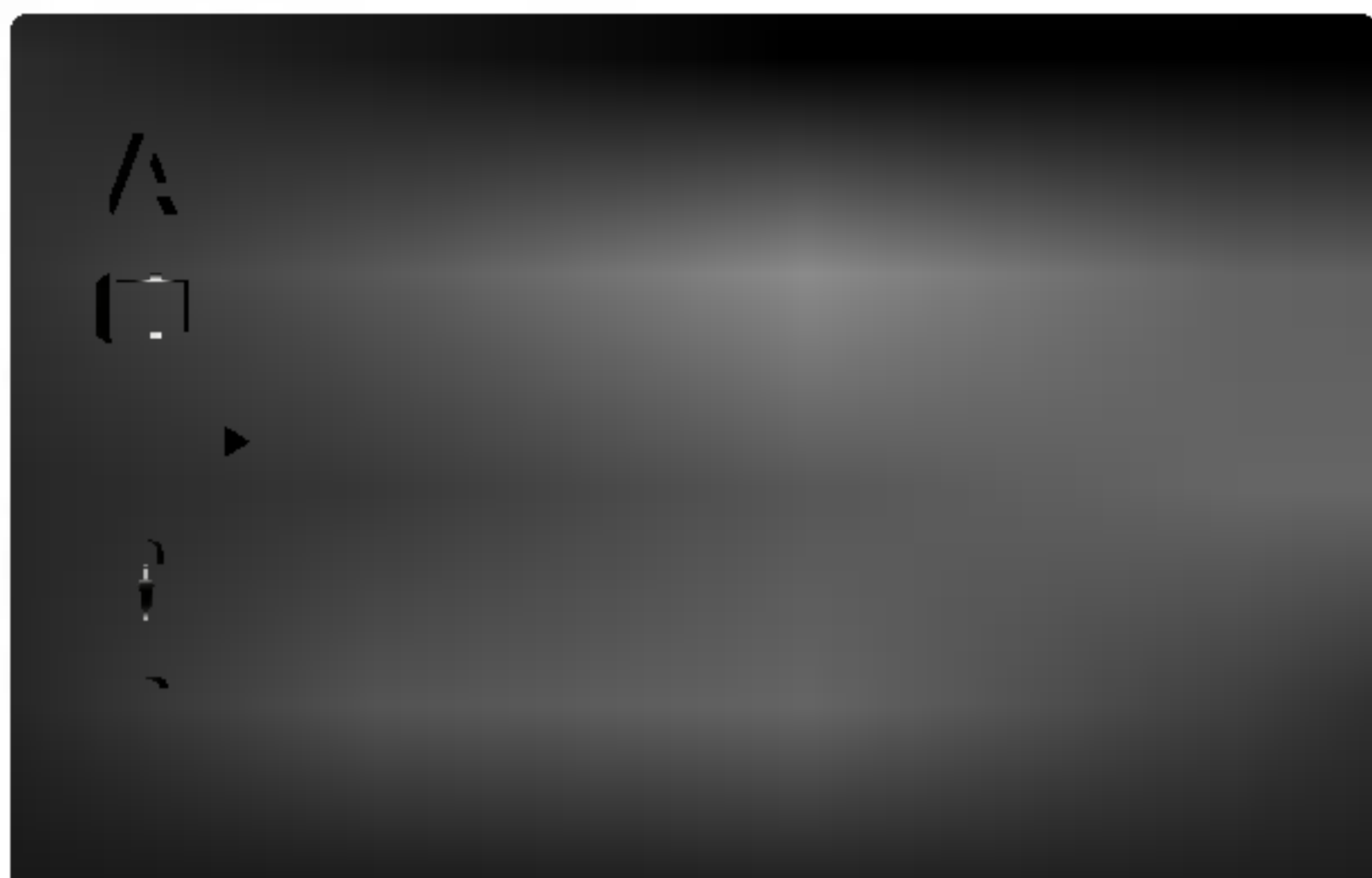

Dolby Digital / DTS / MPEG

Bitstream: Select "Bitstream" if you connect the DVD Player's DIGITAL OUT jack to an amplifier or other equipment with a Dolby Digital or MPEG decoder.

PCM : Select when connected to a two-channel digital stereo amplifier. DVDs encoded in Dolby Digital or MPEG will be automatically downmixed to two-channel PCM audio.

Sample Freq. (Frequency)

If your receiver or amplifier is NOT capable of handling 96 kHz signals, select 48 kHz. When this choice is made, this unit automatically converts any 96 kHz signals to 48 kHz so your system can decode them.

If your receiver or amplifier is capable of handling 96 kHz signals, select 96 kHz. When this choice is made, this unit passes each type of signal through without any further processing.

Check the documentation for your amplifier to verify its capabilities.

Dynamic Range Control (DRC)

With the DVD format, you can hear a program's sound track in the most accurate and realistic presentation possible, thanks to digital audio technology. However, you may wish to compress the dynamic range of the audio output (the difference between the loudest sounds and the quietest ones). This allows you to listen to a movie at a lower volume without losing clarity of sound. Set DRC to On for this effect.

Vocal

Set Vocal to On only when a multi-channel Karaoke DVD is playing. The karaoke channels on the disc will mix into a normal stereo sound.

OTHERS

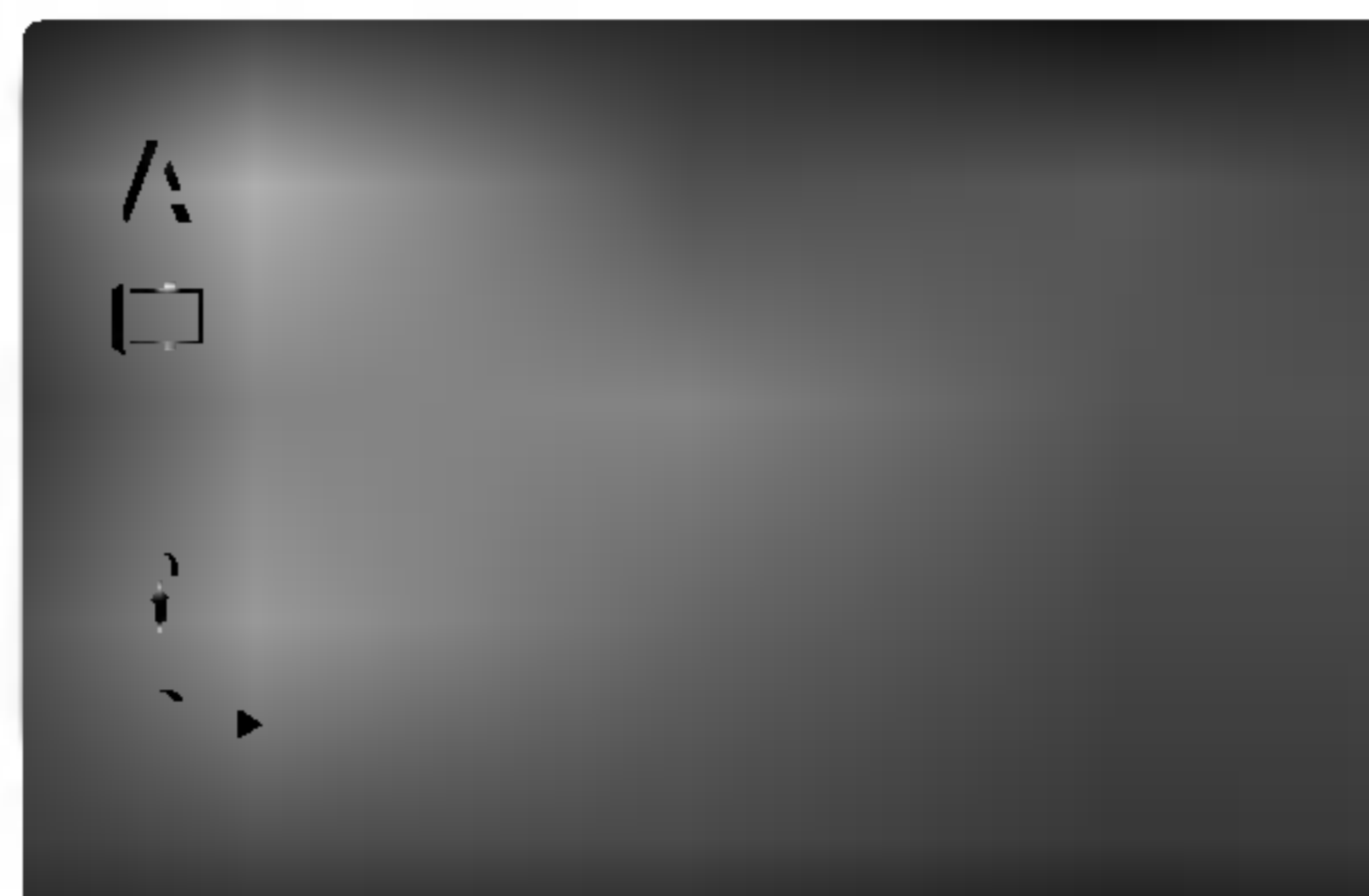

PBC

Set Playback Control (PBC) to On or Off.

On: Video CDs with PBC are played according to the PBC.

Off: Video CDs with PBC are played the same way as Audio CDs.

DivX(R) Registration

You can show the DivX DRM (Digital Right Management) Registration code for your unit only.



The Registration code is used for VOD (Video-On-Demand) service agent. You can purchase or rental an encrypt movie file.

Notes

If you rent the DivX VOD file, it has several options of viewing limits as show below.

- Display the number which you can watch the file.

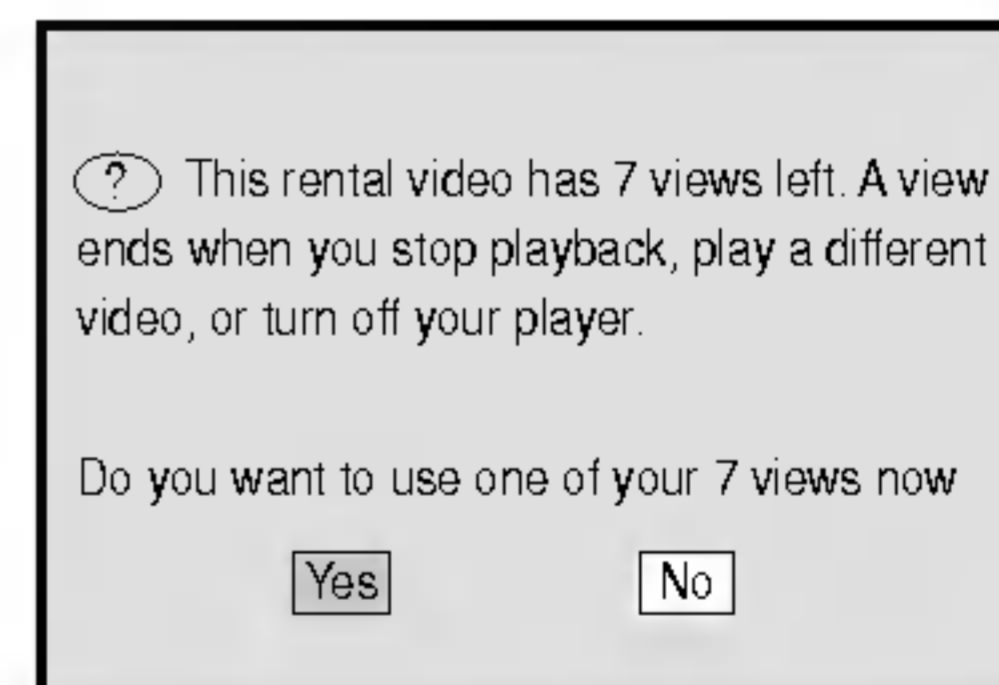

- The rental has been expired.

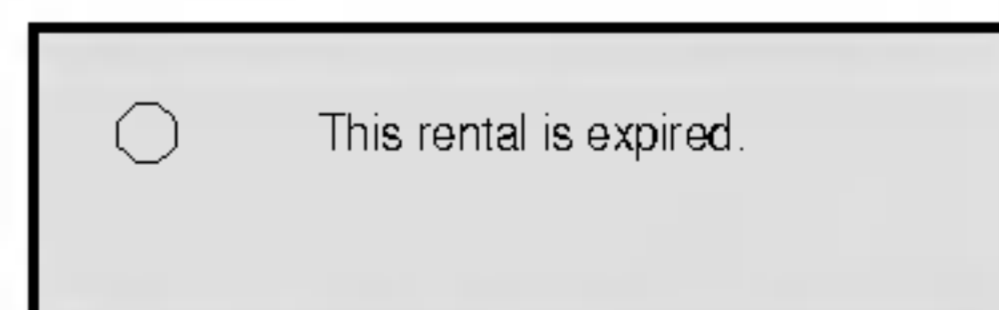

- Display the authorization error.

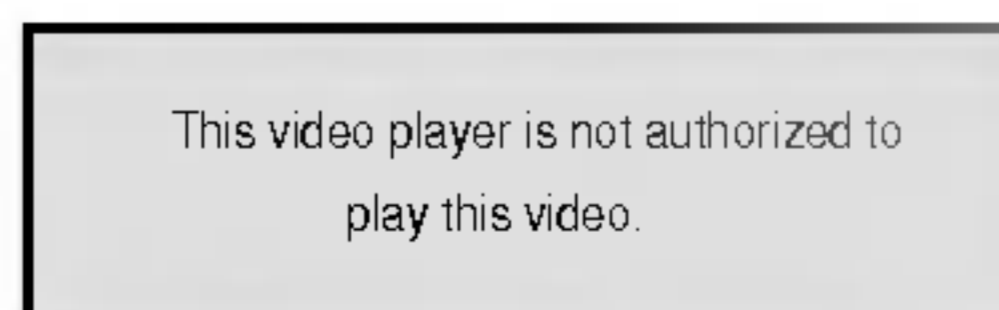

LOCK (Parental Control)



Rating

Some movies contain scenes that may not be suitable for children to view. Many of these discs contain parental control information that applies to the complete disc or to certain scenes on the disc. Movies and scenes are rated from 1 to 8, depending on the country. Some discs offer more suitable scenes as an alternative.

The parental control feature allows you to block access to scenes below the rating you input, thereby preventing your children from being able to view material you believe is unsuitable.

1 Select "Rating" on the LOCK menu then press **▶**.

2 To access the Rating, Password and Country Code features, you must input the 4-digit security code you created.

If you have not yet entered a security code you are prompted to do so.

Input a 4-digit code and press SELECT/ENTER. Enter it again and press SELECT/ENTER to verify. If you make a mistake before pressing SELECT/ENTER, press CLEAR.

3 Select a rating from 1 to 8 using the **▲** / **▼** buttons.

Rating 1-8: Rating one (1) has the most restrictions and rating eight (8) is the least restrictive.

Unlock

If you select unlock, parental control is not active and the disc plays in full.

Note

If you set a rating for the player, all disc scenes with the same rating or lower are played. Higher rated scenes are not played unless an alternate scene is available on the disc. The alternative must have the same rating or a lower one. If no suitable alternative is found, playback stops. You must enter the 4-digit password or change the rating level in order to play the disc.

4 Press SELECT/ENTER to confirm your rating selection, then press SETUP to exit the menu.

Password (Security Code)

You can enter or change password.

- 1 Select Password on the LOCK menu then press **▶**.
- 2 Follow step 2 as shown left (Rating). "Change" or "New" is highlighted.
- 3 Enter the new 4-digit code, then press SELECT/ENTER. Input it again to verify.
- 4 Press SETUP to exit the menu.

If you forget your Security Code

If you forget your security code you can clear it using the following steps:

- 1 Input the 6-digit number "210499" on the setup menu and the security code is cleared.
- 2 Enter a new code as described above.

Note

When "■■■■■■" appears on the TV screen, press STOP (**■**) and then press SETUP to move to the setup menu.

Country Code

Enter the code of the country/area whose standards were used to rate the DVD video disc, based on the list in the reference chapter. (See page 31.)

1 Select "Country Code" on the LOCK menu then press **▶**.

2 Follow step 2 as shown left (Rating).

3 Select the first character using **▲** / **▼** buttons.

4 Shift the cursor using **▶** button and select the second character using **▲** / **▼** buttons.

5 Press SELECT/ENTER to confirm your country code selection.



Playing a DVD and Video CD

Playback Setup

- Turn on the TV and select the video input source connected to the unit.
- Audio system: Turn on the audio system and select the input source connected to the unit.

1 Press OPEN/CLOSE (▲) to open the disc tray.

2 Load your chosen disc in the tray, with the playback side facing down.

3 Press OPEN/CLOSE (▲) to close the tray. READING appears on the TV screen, and playback starts automatically. If playback does not start, press PLAY.
In some cases, the disc menu might appear instead.

If a menu screen is displayed

The menu screen may be displayed first after loading a DVD or Video CD which offer a menu.



Use the ▲ / ▼ / ◀ / ▶ buttons to select the title/chapter you want to view, then press SELECT/ENTER to start. Press TITLE or MENU to return to the menu screen.



Use the number buttons to select the track you want to view and press RETURN to return to the menu screen. Menu settings and operating procedures may differ. Follow the instructions on the each menu screen. You also may set PBC to Off (See "PBC" on page 14).

Notes

- If parental control is set and the disc is not within the rating settings you must input the password. (See "Lock Menu" on page 15.)

General Features

Note

Unless stated otherwise, all operations described use the remote control. Some features may also be available on the Setup menu.

Moving to another TITLE

When a disc has more than one title, you can move to another title. Press DISPLAY while playback is stopped then the appropriate number (0-9) or use ◀ / ▶ to move to another title.

You can play any title by inputting its number while playback is stopped.

Moving to another CHAPTER/TRACK



When a title on a disc has more than one chapter or a disc has more than one track, you can move to another chapter/track as follows:

- Press ◀◀ or ▶▶ briefly during playback to select the next chapter/track or to return to the beginning of the current chapter/track.
- Press ◀◀ twice briefly to step back to the previous chapter/track.
- To go directly to any chapter during DVD playback, press DISPLAY and press ▲ / ▼ to select the chapter/track icon. Then, input the chapter/track number or use ◀ / ▶.

Search

- 1 Press ◀◀ or ▶▶ during playback.
The player will now go into SEARCH mode.
- 2 Press ◀◀ or ▶▶ repeatedly to select the required speed: ◀◀X2, ◀◀X4, ◀◀X8, ◀◀X16, ◀◀X100 (backward) or ▶▶X2, ▶▶X4, ▶▶X8, ▶▶X16, ▶▶X100 (forward).
With a DivX/Video CD, the Search speed changes: ◀◀X2, ◀◀X4, ◀◀X8, ◀◀X16 (backward) or ▶▶X2, ▶▶X4, ▶▶X8, ▶▶X16 (forward).
- 3 To exit SEARCH mode, press PLAY.



General Features (continued)

Still Picture and Frame-by-frame playback

- 1 Press PAUSE/STEP on the remote control during playback.
The player will now go into PAUSE mode.
- 2 You can advance the picture frame-by-frame by pressing PAUSE/STEP repeatedly on the remote control.
- 3 To exit still motion mode, press PLAY.

Slow Motion

- 1 Press ◀▶ or ▶▶ during playback.
The player will enter SLOW mode.
- 2 Use the ◀▶ or ▶▶ to select the required speed: ◀▶ 1/2, ◀▶ 1/4, ◀▶ 1/8 or ◀▶ 1/16 [(backward) - DVD only] or ▶▶ 1/2, ▶▶ 1/4, ▶▶ 1/8 or ▶▶ 1/16 (forward).
- 3 To return to normal PLAY, press PLAY.

Note

Slow motion playback in reverse is not applicable for Video CD.

Repeat

You can play a title/chapter/all/track on a disc.

Press REPEAT during playback to select a desired repeat mode.

DVD Video Discs - Repeat Chapter/Title/Off

- Chapter: repeats the current chapter.
- Title: repeats the current title.
- Off : does not play repeatedly.

DivX/Video CDs - Repeat Track/All/Off

- Track : repeats the current track
- All : repeats all the tracks on a disc.
- Off : does not play repeatedly.

Note

– On a Video CD with PBC, you must set PBC to Off on the setup menu to use the repeat function (See “PBC” on page 14).

Repeat A-B

To repeat a sequence in a title:

- 1 Press REPEAT A-B at your chosen starting point.
“A - ” appears briefly on the TV screen.
- 2 Press REPEAT A-B again at your chosen end point.
“A - B” appears briefly on the TV screen, and the repeat sequence begins.
- 3 To cancel the sequence, press REPEAT A-B.

Time Search

The Time Search function allows you to start playing at any chosen time on the disc.

- 1 Press DISPLAY during playback. The on-screen display appears on the screen.
The Time Search box shows the elapsed playing time of the current disc.
- 2 Within 10 seconds, press ▲ / ▼ to select the Time Search icon in the on-screen display.
The “-:--:--” appears in the Time Search box.
- 3 Within 10 seconds, use the number buttons to enter the required start time. Enter hours, minutes, and seconds from left to right in the box.
If you enter the wrong numbers, press CLEAR to remove the numbers you entered. Then enter the correct numbers.
- 4 Within 10 seconds, press SELECT/ENTER to confirm the start time.
Playback starts from the selected time on the disc. If you enter an invalid time, playback will continue from the current point.

Last Scene Memory

This player memorizes last scene from the last disc that is viewed. The last scene remains in memory even if you remove the disc from the player or switch off the player. If you load a disc that has the scene memorized, the scene is automatically recalled.

Note

This player does not memorize the scene of a disc if you switch off the player before commencing to play the disc.



General Features (continued)

Zoom

The Zoom function allows you to enlarge the video image and to move through the enlarged image.

- 1 Press ZOOM during playback or still playback to activate the Zoom function.

If you press ZOOM repeatedly, the magnification level increases up to four steps.

100% size (screen fit mode) → 400% size → 800% size → 1600% size → 100% size (screen fit mode)

- 2 Use the / / / buttons to move through the zoomed picture.

Note

The zoom function may not work for some DVDs.

Marker Search

You can start playback from a memorized point. Up to nine points can be memorized.

To enter a mark, follow these steps.

- 1 During disc playback, press MARKER when playback reaches the spot that you want to memorize.
The Marker icon will appear on the TV screen briefly.
- 2 Repeat step 1 to enter up to nine Marker points on a disc.

To Recall a Marked Scene

- 1 During disc playback, press SEARCH.
The MARKER SEARCH menu will appear on the screen.
- 2 Within 10 seconds, press / to select a Marker number that you want to recall.
- 3 Press SELECT/ENTER.
Playback will start from the Marked scene.
- 4 To remove the MARKER SEARCH menu, press SEARCH.

To clear a Marked Scene

- 1 During disc playback, press SEARCH.
The MARKER SEARCH menu will appear on the screen.
- 2 Press / to select the Marker number that you want to erase.
- 3 Press CLEAR.
The Marker number will be erased from the list.
- 4 Repeat steps 2 and 3 to erase additional Marker numbers.
- 5 To remove the MARKER SEARCH menu, press SEARCH.

Special DVD Features

Checking the contents of DVD Video discs: Menus

DVDs may offer menus that allow you to access special features. To use the disc menu, press MENU. Then, press the appropriate number button to select an option. Or, use the / / / buttons to highlight your selection, then press SELECT/ENTER.

Title Menu

- 1 Press TITLE.
If the current title has a menu, the menu will appear on the screen. Otherwise, the disc menu may appear.
- 2 The menu can list camera angles, spoken language and subtitle options, and chapters for the title.
- 3 To remove the title menu, press TITLE again.

Disc Menu

Press MENU.

The disc menu is displayed.

Camera Angle

If the disc contains scenes recorded at different camera angles, you can change to a different camera angle during playback.

- 1 Press DISPLAY and then press the / to select a angle.
The number of the current angle appears on the display window.
- 2 Select a desired angle pressing the / buttons.

Changing the Audio Language

Press AUDIO repeatedly during playback to hear a different audio language or audio track.

Changing the Audio Channel

Press AUDIO repeatedly during playback to hear a different audio channel (Left, Right or Stereo).

Subtitle

Press SUBTITLE (S-TITLE) repeatedly during playback to see the different subtitle languages.

Note

If appears, the feature is not available on the disc.



Operation with Audio CD and MP3/WMA Disc

Playing an Audio CD and MP3/WMA

Disc

The unit can play MP3/WMA formatted recordings on CD-ROM, CD-R, or CD-RW discs.

Audio CD

Once you insert an audio CD a menu appears on the TV screen. Press \blacktriangle / \blacktriangledown to select a track then press PLAY or SELECT/ENTER and playback starts.

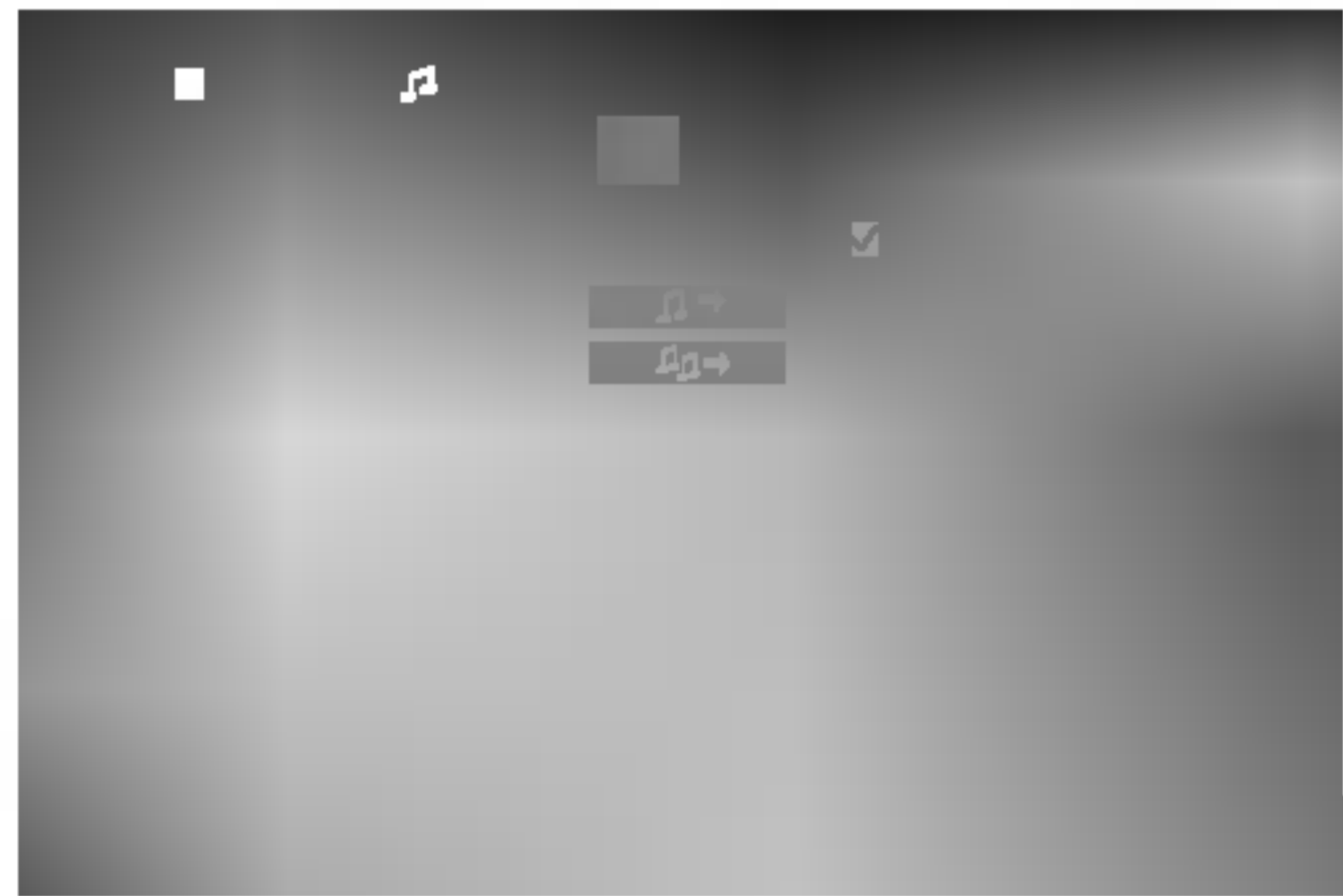

MP3 / WMA

1. Press \blacktriangle / \blacktriangledown to select a folder, and press SELECT/ENTER to see the folder contents.
2. Press \blacktriangle / \blacktriangledown to select a track then press PLAY or SELECT/ENTER. Playback starts.

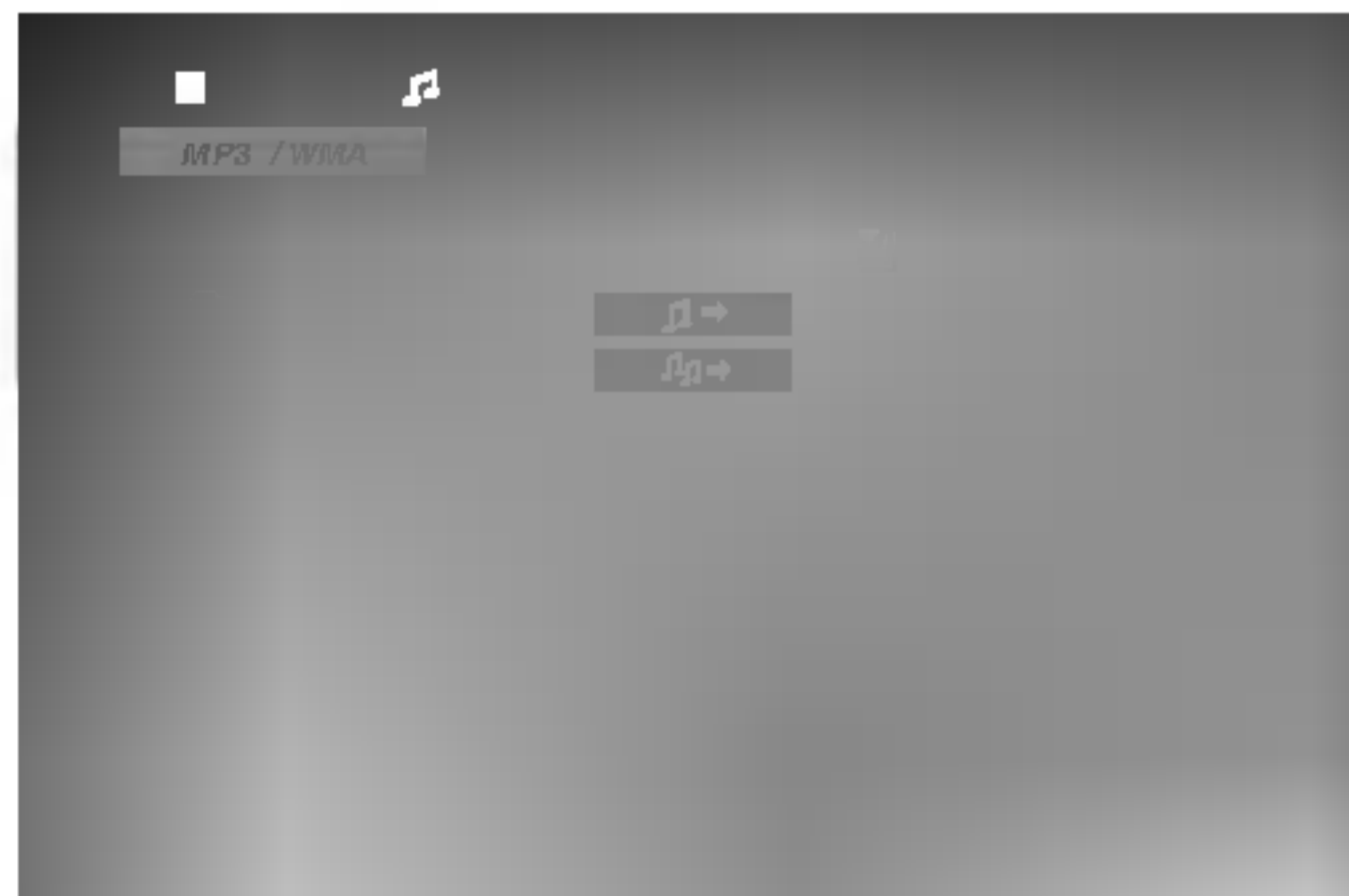

Notes

- If you are in a file list on the MP3/WMA menu and want to return to the Folder list, use the \blacktriangle / \blacktriangledown to highlight \square on the stop mode and press SELECT/ENTER.
- Press MENU to move to the next page.
- On a CD with MP3/WMA file and JPEG file, you can switch MP3/WMA and JPEG menu. Press TITLE and MP3/WMA or JPEG word on top of the menu is highlighted. Then, use \blacktriangleleft / \blacktriangleright to select MP3/WMA or JPEG then press SELECT/ENTER.

Pause

- 1 Press PAUSE/STEP during playback.
- 2 To return to playback, press PLAY or press PAUSE/STEP again.

Moving to another Track

- Press \blacktriangleleft or \blacktriangleright briefly during playback to go to the next track or to return to the beginning of the current track.
- Press \blacktriangleleft twice briefly to step back to the previous track.
- In case of audio CD, to go directly to any track, enter the track number using the numbered buttons (0-9) during playback.

Repeat Track/All/Off

- 1 To repeat the track currently playing, press REPEAT. The Repeat icon and "TRACK" appears on the menu screen.
- 2 To repeat all tracks on a disc, press REPEAT a second time. The Repeat icon and "ALL" appears on the menu screen.
- 3 To cancel Repeat mode, press REPEAT a third time. The Repeat icon and "OFF" appears on the menu screen.

Search

- 1 Press \blacktriangleleft or \blacktriangleright during playback. The player will now go into SEARCH mode.
- 2 Press \blacktriangleleft or \blacktriangleright repeatedly to select the required speed: \blacktriangleleft X2, \blacktriangleleft X4, \blacktriangleleft X8 (backward) or \blacktriangleright X2, \blacktriangleright X4, \blacktriangleright X8 (forward). Search speed and direction are indicated on the menu screen.
- 3 To return to playback, press PLAY.

MP3 / WMA disc compatibility with this player is limited as follows:

- Sampling frequency: within 32 - 48 kHz (MP3), within 24 - 48kHz (WMA)
- Bit rate: within 32 - 320kbps (MP3), 40 - 192kbps (WMA)
- The player cannot read an MP3/WMA file that has a file extension other than ".mp3" / ".wma".
- CD-R physical format should be ISO 9660
- If you record MP3 / WMA files using software that cannot create a file system (eg. Direct-CD) it is impossible to playback MP3 / WMA files. We recommend that you use Easy-CD Creator, which creates an ISO 9660 file system.
- File names should have a maximum of 8 letters and must incorporate an .mp3 or .wma extension.
- They should not contain special letters such as / ? * : " < > | etc.
- The total number of files on the disc should be less than 999.

This DVD player requires discs and recordings to meet certain technical standards in order to achieve optimal playback quality. Pre-recorded DVDs are automatically set to these standards. There are many different types of recordable disc formats (including CD-R containing MP3 or WMA files) and these require certain pre-existing conditions (see above) to ensure compatible playback.

Customers should note that permission is required in order to download MP3 / WMA files and music from the Internet. Our company has no right to grant such permission. Permission should always be sought from the copyright owner.



Viewing a JPEG disc

This unit can play discs with JPEG files. Before playing JPEG recordings, read the notes on JPEG Recordings on right.

- 1 Insert a disc and close the tray.**
The JPEG menu appears on the TV screen.



- 2 Press ▲ / ▼ to select a folder, and press SELECT/ENTER. A list of files in the folder appears.**



Tip
If you are in a file list and want to return to the Folder list, use the ▲ / ▼ buttons on the remote to highlight "■" and press SELECT/ENTER to return to the previous menu screen.

- 3 If you want to view a particular file, press ▲ / ▼ to highlight a file and press SELECT/ENTER or PLAY.**
Slide Show starts from the selected file if Speed option is not Off.
While viewing a file, you can press STOP(■) to move to the previous menu (JPEG menu).



- Press MENU to move to the next page.
- There are four Slide Speed options: ■ : > (Slow), >> (Normal), >>> (Fast) and II (off).
Use ▲ / ▼ / ◀ / ▶ to highlight the Speed. Then, use ◀ / ▶ to select the option you want to use then press SELECT/ENTER.
- If you set Speed option to Off, Slide Show is not active.

Slide Show

Use ▲ / ▼ / ◀ / ▶ to highlight the ■ (Slide Show) then press SELECT/ENTER.

Moving to another File

Press ◀◀ or ▶▶ once during viewing a picture to advance to the next file or to the previous file.

Still Picture

- 1 Press PAUSE/STEP during slide show.
The player will now go into PAUSE mode.
- 2 To return to the slide show, press PLAY or press PAUSE/STEP again.

JPEG disc compatibility with this player is limited as follows:

- Depending upon the size and number of JPEG files, it could take a long time for the DVD player to read the disc's contents. If you don't see an on-screen display after several minutes, some of the files may be too large — reduce the resolution of the JPEG files to less than 2760 x 2048 pixels and burn another disc.
- The total number of files and folders on the disc should be less than 999.
- Some discs may be incompatible due to a different recording format or the condition of disc.
- Ensure that all the selected files have the ".jpg" extensions when copying into the CD layout.
- If the files have ".jpe" or ".jpeg" extensions, please rename them as ".jpg" file.
- File names without ".jpg" extension will not be able to be read by this DVD player. Even though the files are shown as JPEG image files in Windows Explorer.



The Program function enables you to store your favorite tracks from any disc in the player memory. A program can contain 300 tracks (Audio CD/MP3/WMA).

1 Insert a disc.

Audio CD and MP3/WMA Discs:

Audio CD or MP3/WMA menu appears as below.

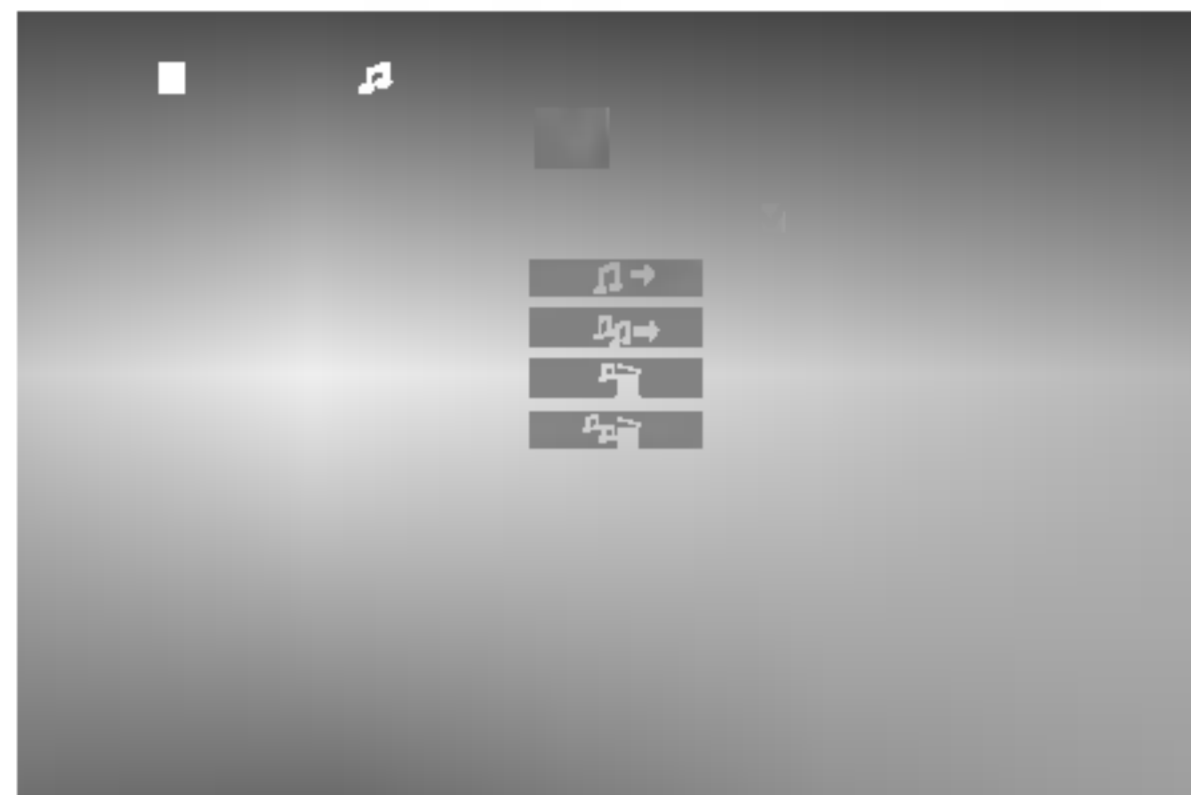

Audio CD Menu

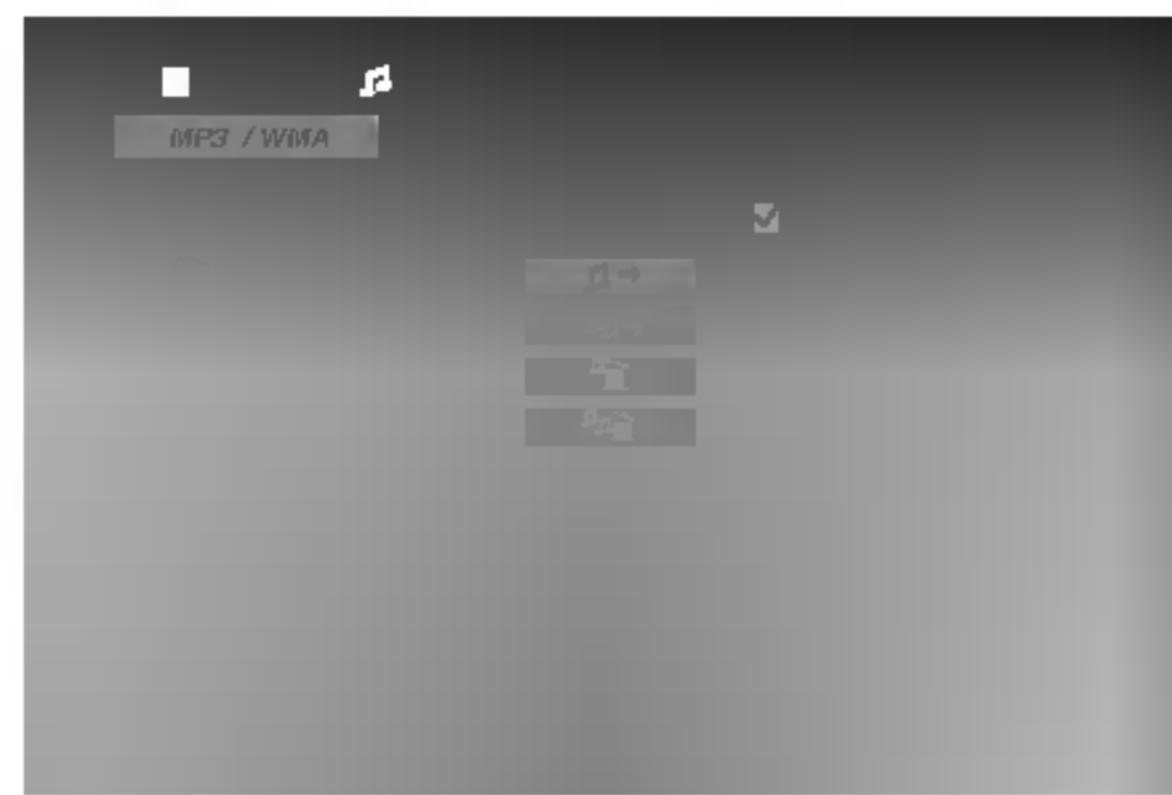

MP3/WMA Menu

2 Select a track on the List.

3 Press PROGRAM. Or, select “ (Add)” icon then SELECT/ENTER to place the selected track on the Program list. Repeat to place additional tracks on the list.

Note

You can add all tracks in the disc. Select “ (Add All)” icon then press SELECT/ENTER.

4 Select the track you want to start playing on the Program list.

Tip

Press MENU to move to the next page.

5 Press PLAY or SELECT/ENTER to start.





Playback begins in the order in which you programmed the tracks and “PROG.” appears on the display window. Playback stops after all of the tracks on the Program list have played once.

Repeat Programmed Tracks

You can play a title/chapter/all/track on a disc.

- 1 Press REPEAT when playing a disc. The repeat icon appears.
- 2 Press REPEAT to select a desired repeat mode.
 - Track: repeats the current track
 - All: repeats all the tracks on a disc.
 - Off(No display): does not play repeatedly.

Erasing a Track from Program List

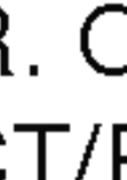
- 1 Use  /  /  /  to select the track that you wish to erase from the Program list.
- 2 Press CLEAR. Or, select “ (Delete) icon then Press SELECT/ENTER to place the selected track on the Program list. Repeat to erase additional tracks on the list.

Erasing the Complete Program List

Select “ (Del all)”, then press SELECT/ENTER. The complete Program for the disc is erased.

Note

The programs are also cleared when the disc is removed.

To resume normal playback from programmed playback
Select a track on the List then press SELECT/ENTER. “PROG.” disappears from the display window.



The unit can play the DivX files.

- 1 Insert a disc and close the tray.**
The DivX menu appears on the TV screen.



- 2 Press ▲ / ▼ to select a folder, and press SELECT/ENTER to see the folder contents.**



Tip
If you are in a file list and want to return to the Folder list, use the ▲ / ▼ buttons on the remote control to highlight "■" and press SELECT/ENTER to return to the previous menu screen.

- 3 If you want to view a particular file, press ▲ / ▼ to highlight a file and press SELECT/ENTER or PLAY.**
Playback starts.

- 4 Press STOP(■) to exit.**



- Notes**
- Be sure to select "SUBTITLE ON" mode by pressing the subtitle file every time before playing a DivX file .
 - When the subtitle has more than two languages in the file, original subtitle is only available.

Display

Press DISPLAY during playback.

General playback status can be displayed on the TV screen.

DivX disc compatibility with this player is limited as follows:

- Available resolution size of the DivX file is under 720x576 (W x H) pixel.
- The file name of the DivX subtitle is available by 20-40 characters (differs from language).
- If there is impossible code to express in the DivX file, it may be displayed as " _ " mark on the display.
- **If the number of the screen frame is over 30 per 1 second, this unit may not operate normally.**
- **If the video and audio structure of recorded file is not interleaved, either video or audio is outputted.**
- **If the file is recorded with GMC, the unit supports some of 1-point of the record level.**
* GMC?
GMC is the acronym for Global Motion Compensation. It is an encoding tool specified in MPEG4 standard. Some MPEG4 encoders, like DivX or Xvid, have this option. There are different levels of GMC encoding, usually called 1-point, 2-point, or 3-point GMC.

Playable DivX subtitle file

- ".srt ", ".smi ", ".sub "

Playable DivX file

- ".avi ", ".mpg ", ".mpeg "

Playable Codec format

- "DIVX3.xx ", "DIVX4.xx ", "DIVX5.xx ", "XVID ", "MP43 ", "3IVX ", "MP42 "

Playable Audio format

- "AC3 ", "DTS ", "PCM ", "MP3 ", "WMA "
 - Sampling frequency: within 32 - 48 kHz (MP3), within 24 - 48kHz (WMA)
 - Bit rate: within 32 - 320kbps (MP3), 40 - 192kbps (WMA)



Presetting the radio stations

You can preset 50 stations for FM and AM. Before tuning, make sure that you have turned the volume down to the minimum level.

1 Press TUNER/BAND to show either FM or AM in the display window.

Every time you press this button, AM and FM changes alternately.

2 Press TUNING (-/+) on the front panel until the frequency indication starts to change.

Notes

• Automatic Tuning

Press the TUNING (-/+) for more than 0.5 second.
- Scanning stops when the unit tunes in a station.

• Manual Tuning

Use the MULTI JOG DIAL.

3 Press PROGRAM/MEMORY on the front panel.

A preset number will flash in the display window.

4 Press PRESET (-/+) (or PRESET ∇ / \blacktriangle on the remote control) to select the preset number you want.

5 Press PROGRAM/MEMORY again.

The station is stored.

6 Repeat steps 2 to 5 to store other stations.

To clear all memorized stations

Press and hold **PROGRAM/MEMORY** on the front panel for about two seconds, "*CLEAR ALL*" appears in the display window and then press **CLEAR** on the front panel, the stations are cleared.

For your reference

If all stations have already been entered, "*MEM FULL*" message will appear in the display window for a moment and then a preset number will flash. To change the preset number, follow the steps 4-5.

To recall preset numbers

Press and hold **PRESET (-/+)** (or **PRESET ∇ / \blacktriangle** on the remote control) until the desired preset number appears or press the button repeatedly.

Listening to the radio

1 Press TUNER/BAND to select either AM or FM in the display window.

The last received station is tuned in.

2 Press PRESET (-/+) (or PRESET ∇ / \blacktriangle on the remote control) repeatedly to select the preset station you want.

Each time you press this button, the unit tunes in the next preset station.

3 Adjust the volume by rotating VOLUME knob (or pressing VOLUME +/- on the remote control) repeatedly.

To listen to non-preset radio stations

- For manual tuning, see "Manual Tuning".
- For automatic tuning, see "Automatic Tuning".

To turn the radio off

Press **POWER** to turn off the unit or to select another function mode (TAPE, DVD/CD/KARAOKE or AUX).

For your reference

• If a FM program is noisy

Press **MODE/RIF** repeatedly so that "ST" disappears in the display window. There will be no stereo effect, but the reception will improve. Press **MODE/RIF** again to restore the stereo effect.

• To improve reception

Reposition the supplied antennas.

Notes

- Use **MODE/RIF** (Radio Interference Filter) function to switch to Mono reception if stereo reception is distorted by noise.
- While recording weak AM broadcasts, if noises occurs, press **MODE/RIF** once.



Basic Playback

- 1** Press **TAPE** to select tape function.
(“NO TAPE” appears in the display window.)
- 2** Open cassette deck by pushing to the **▲PUSH EJECT** position.
- 3** Insert a cassette with the tape side to the bottom and then close deck.
- 4** Press **▶**(or **◀** : optional) on the front panel or remote control.

AUTO STOP DECK

After auto stop deck plays front side of cassette, the unit stops automatically.

AUTO REVERSE DECK : OPTIONAL

You can select direction of the cassette you want by pressing **PLAY MODE**.

Pressing	Display	Function
-		After the cassette plays front or reverse (backward play) side, stops automatically.
Once		After the cassette plays front and reverse side, stops automatically.
Twice		After the cassette of plays six times repeatedly front and reverse side, stops automatically.

To Stop Play

Press **STOP(■)/CLEAR** on the front panel or **TAPE STOP (■)** on the remote control during playback.

Tape Counter Reset

Press **COUNTER RESET (COUNT.RESET)** during playback.

Playing time appears “TAPE 0000” in display window.

To Play Rewind or Fast Forward

After press **◀◀/▶▶** on the front panel or on the remote control during playback or stop, press **▶** (or **◀** : optional) at the tape position you want.

Recording from Radio, CD or Auxiliary source

- 1** Press the function (CD, TUNER/BAND or AUX) you want.
- 2** Open the cassette deck and insert a blank cassette into the cassette compartment.
To set the recording direction : OPTIONAL
Press **PLAY MODE** repeatedly to set the recording direction.
- 3** Press **●REC/||** on the front panel or **●/||** on the remote control.
“REC” flashes and holds the cassette in pause mode.
- 4** Press **●REC/||** on the front panel or **●/||** remote control.
The recording is begun.
To pause the recording
Press **●/||** (or **●REC/||**) during recording .
To stop the recording
Press **STOP(■)**.

CD- Synchro recording

This feature is a convenient to record tracks from CD to cassette.

- 1** Select the CD function and load a CD to be recorded.
You may wish to program a selection of tracks for recording.
- 2** Open the cassette deck and insert a blank cassette into the tape tray.
To set the recording direction
Press **PLAY MODE** repeatedly to set the recording direction.
- 3** Press **CD SYNC.** in stop mode.
“REC” flashes and “CD SYNC” displays in the display window.
- 4** The synchronized recording is started automatically after about 7 seconds.

Notes

- If you wish to record from the desired track, select the desired track with **MULTI JOG DIAL** before commencing CD synchro recording.
- A function change is not possible during recording.





You can play KARAOKE (singing along) with karaoke disc by connecting a microphone to the unit. You can enjoy KARAOKE with a stereo-recorded disc, even if it is a non-karaoke disc, by reducing the singer's voice.

Karaoke Basic Playback

- 1** Check if the system is connected.
(Refer to the page 6-8.)
- 2** Turn on the powers of TV (or Amplifier) and DVD Karaoke and enter to the video mode on TV.
- 3** Press OPEN/CLOSE (▲) to open the disc tray and load supplied karaoke disc in the tray with the label facing up.
- 4** Press OPEN/CLOSE (▲) to close the tray.
- 5** Press DVD/KARAOKE twice to enter to the karaoke mode.

[TV Screen]



- 6** Connect the microphone to the MIC jack.
- 7** Select the melody number you want by pressing NUMERIC buttons.
If you cancel the selected melody number, press the CLEAR.
- 8** Press PLAY (▶).
The selected melody number is played.
Sing in tone with microphone.
After melody ends, it is stopped automatically and score appears.

Karaoke Advanced Playback

To Adjust MIC Volume

Turn the MIC VOLUME CONTROL on the front panel clockwise to increase the volume, or counterclockwise to decrease it.

To Adjust ECHO Volume

You can give an echo effect to the sound from the microphones.

Press the ECHO repeatedly.

ECHO - OFF → ECHO - 1 → ECHO - 2



Key Control

You can change the key to suit your vocal range. You can adjust the key to 13 steps (6steps higher, 6steps lower and the original key).
- The setting appears on the screen.

Press KEY CONTROL (b/#) repeatedly on the remote control or turn KEY CONTROL (b/#) on the front panel to find the key that suits your vocal range.

- To flatten the key one by one, press the KEY CONTROL (b) repeatedly during playback.
- To sharp the key one by one, press the KEY CONTROL (#) repeatedly during playback.
- To return to the original key, press the KEY CONTROL (b/#) repeatedly to appear the original key.



Reserving the Songs

When you want to make a reservation of next melody, you can enjoy the most 8 melodies reservation Without waiting.

1 Press the NUMERIC buttons to reserve melody number you want in the karaoke disc play mode.

Melody number appears on the TV screen.

2 Press PROGRAM.

The melody number is made a reservation.

3 Repeat steps 1-2.

You can reserve 8 songs.



After the one song finishes its playback, the next song will be playback automatically.

To cancel the reserved song

Each time you press CLEAR, the reserved song will be cancelled one by one.

To cancel or change the wrong reserved song

Press the PROGRAM to move to the desired position, then press the CLEAR to cancel the reserved song.

Male/Female Function

If you want to sing a song of MAN's or WOMEN's key, press MALE(♂)/FEMALE(♀) button repeatedly to change MAN's or WOMEN's key.

Tempo Change

You can use this function when you want to play fast or slow.

- Press TEMPO (+) repeatedly during singing to play faster.
- Press TEMPO (-) repeatedly during singing slower.

Shadow Function

If Video CD caption and the song's subtitle are mixed up, the song's subtitle may be invisible. In this case, to highlight the song's subtitle, press SHADOW.

- It will be highlighted by background shadow image.

Karaoke MENU Playback

Preparation

Press MENU on the karaoke mode.

The main MENU appears on the screen.

Main MENU (On the TV screen)

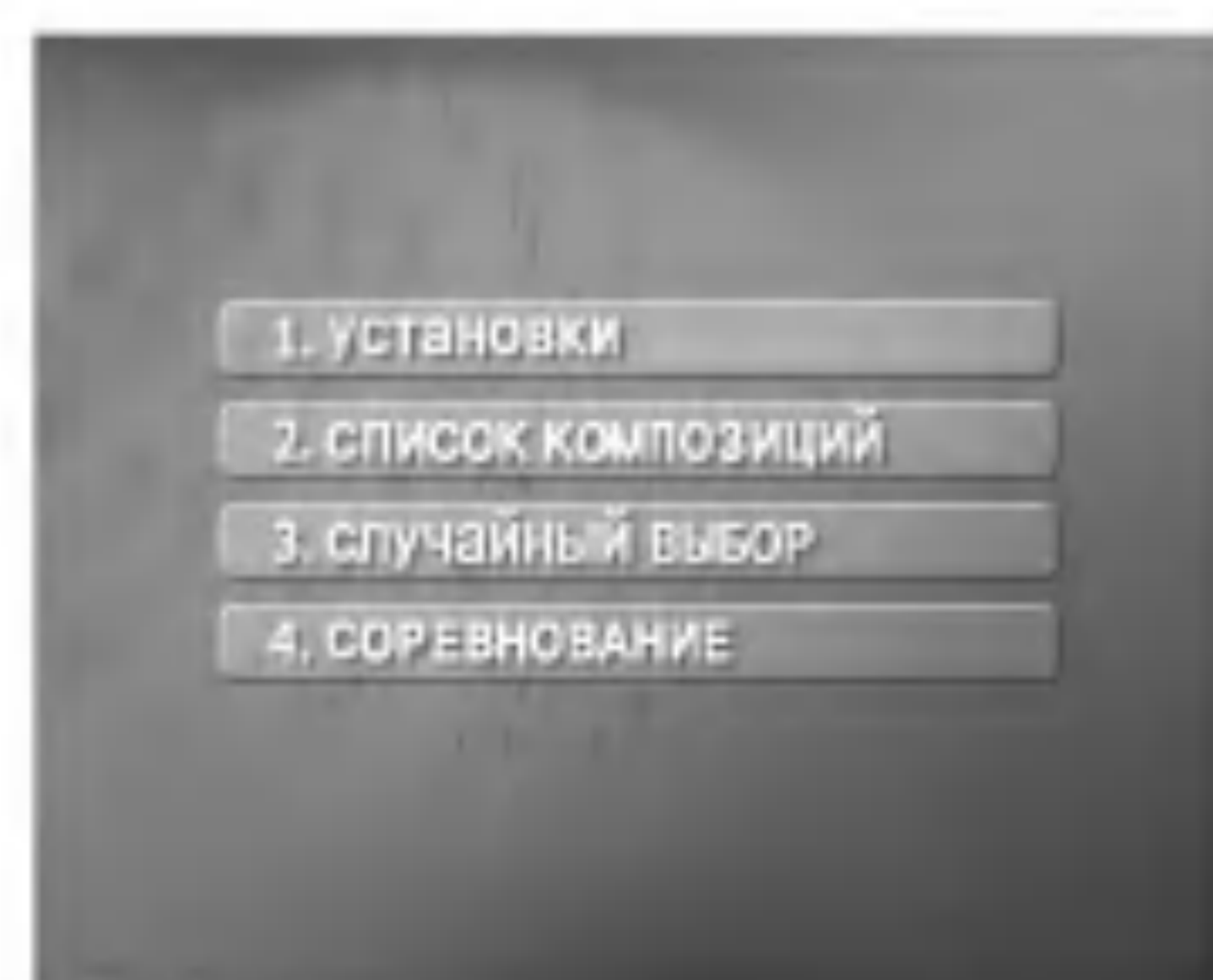

SETUP (УСТАНОВКИ)

1 Select 1. УСТАНОВКИ by pressing ▲ / ▼ on the main menu.

2 Use ◀ / ▶ to select the desired option, and press SELECT/ENTER.

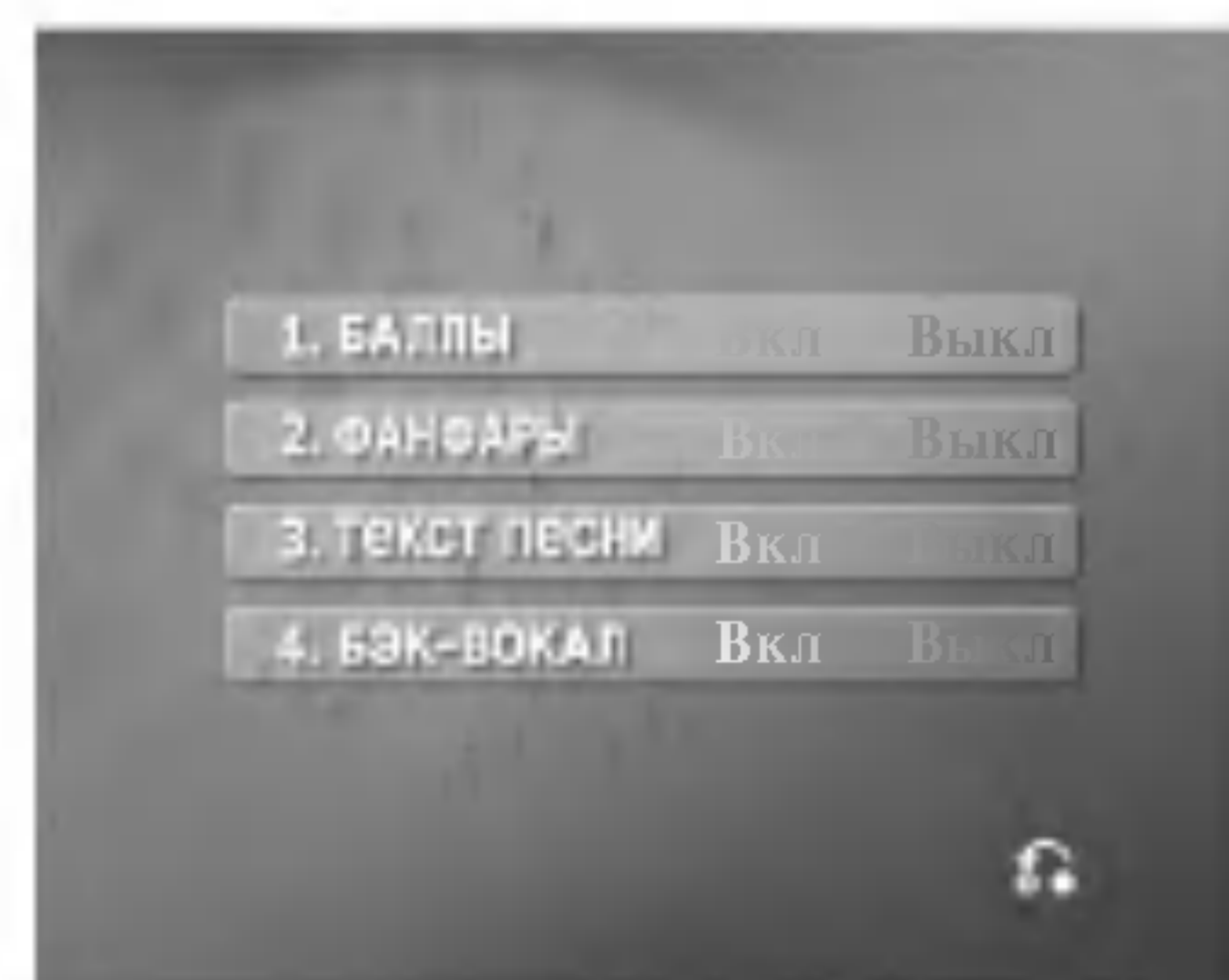

SCORE ON/OFF (1. БАЛЛЫ Вкл Выкл)

■: When singing by selection of melody, song score comes out after one piece of song is ended.

To cancel it, select the ■.

FANFARE ON/OFF (2. ФАНФАРЫ Вкл Выкл)

■: In condition of POWER ON, scoring fanfare operates. The fanfare sound comes out after singing finished.

To cancel it, select the ■.

LYRIC ON/OFF (3. ТЕКСТ ПЕСНИ Вкл Выкл)

■: When singing by selection of melody, song lyric appears on the TV screen.

To cancel it, select the ■.

CHORUS ON/OFF (4. БЭК-ВОКАЛ Вкл Выкл)

■: When singing by selection of melody, song chorus is heard a sound.

To cancel it, select the ■.

Note

To move to the main menu, press MENU or RETURN.



MUSIC LIST (СПИСОК КОМПОЗИЦИЙ)

LOCAL SONG (1. РОССИЙСКИЕ ПЕСНИ) and POP SONG (2. ЗАРУБЕЖНЫЕ ПЕСНИ)

1 Select 2. СПИСОК КОМПОЗИЦИЙ by pressing the ▲ / ▼ on the main menu.

The LOCAL SONG, POP SONG and CLASSIC menu will be shown on the TV screen.

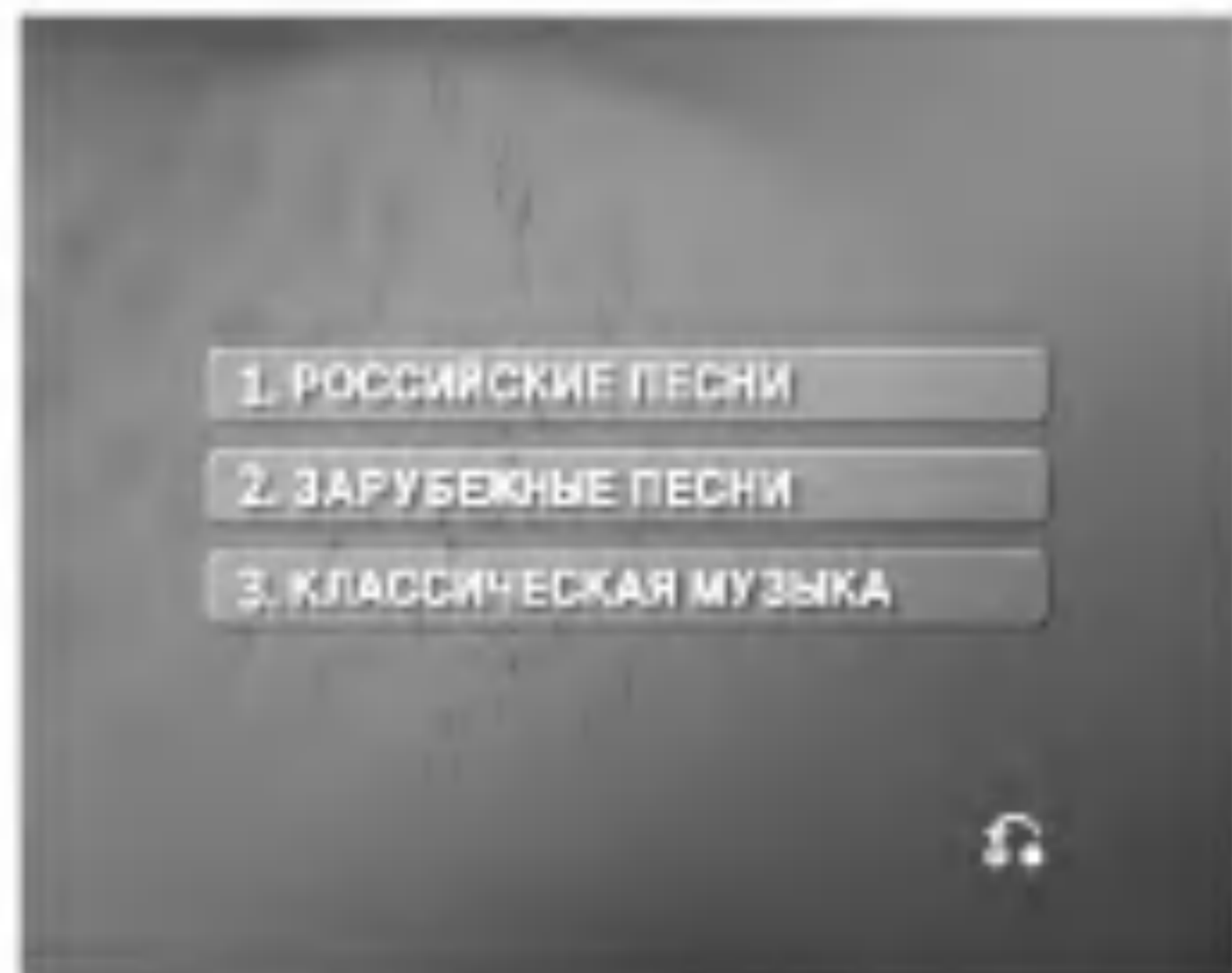

2 Select 1. РОССИЙСКИЕ ПЕСНИ or 2. ЗАРУБЕЖНЫЕ ПЕСНИ by pressing the ▲ / ▼, and press SELECT/ ENTER. SONG LIST and SINGER LIST menu will be shown on the TV screen.

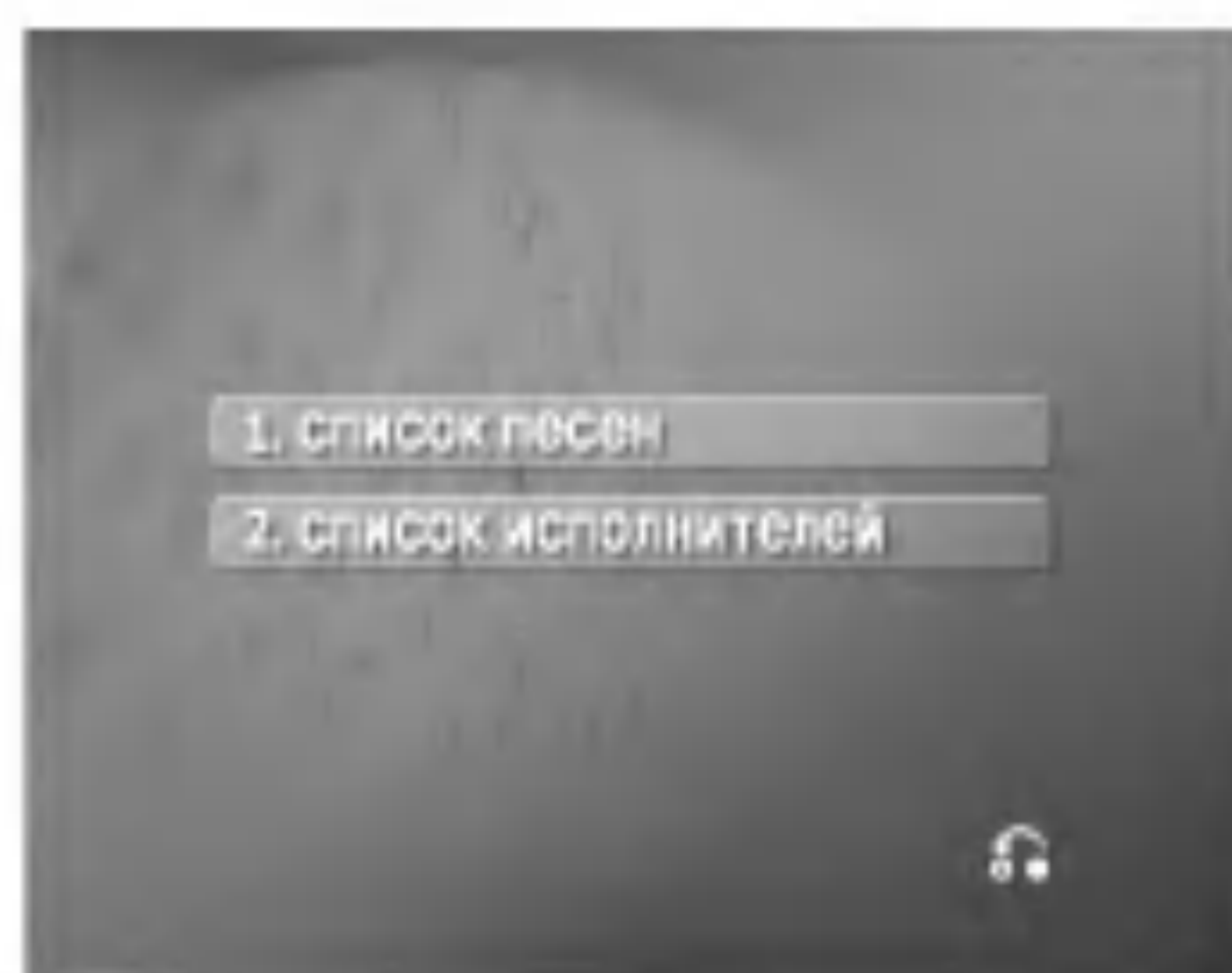

SONG LIST (1. СПИСОК ПЕСЕН)

1 Select 1. СПИСОК ПЕСЕН and select the initial of the song title you want by pressing the ▲ / ▼, then press SELECT/ ENTER.

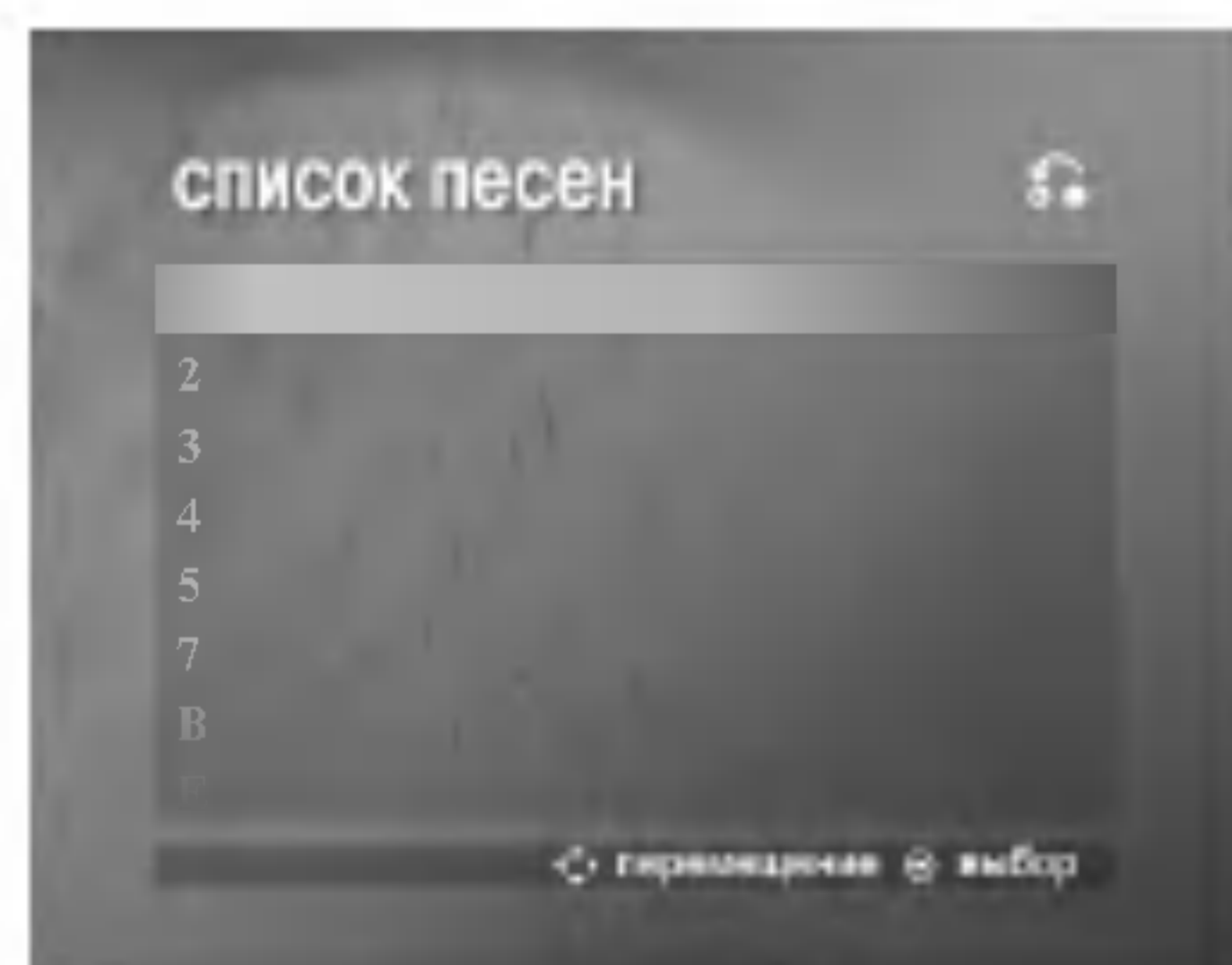

2 Select the song title you want by pressing the ▲ / ▼, and press SELECT/ ENTER.



SINGER LIST (2. СПИСОК ИСПОЛНИТЕЛЕЙ)

1 Select 2. СПИСОК ИСПОЛНИТЕЛЕЙ and select the initial of the singer you want by pressing the ▲ / ▼ in the SONG LIST and SINGER LIST menu, and press SELECT/ ENTER.

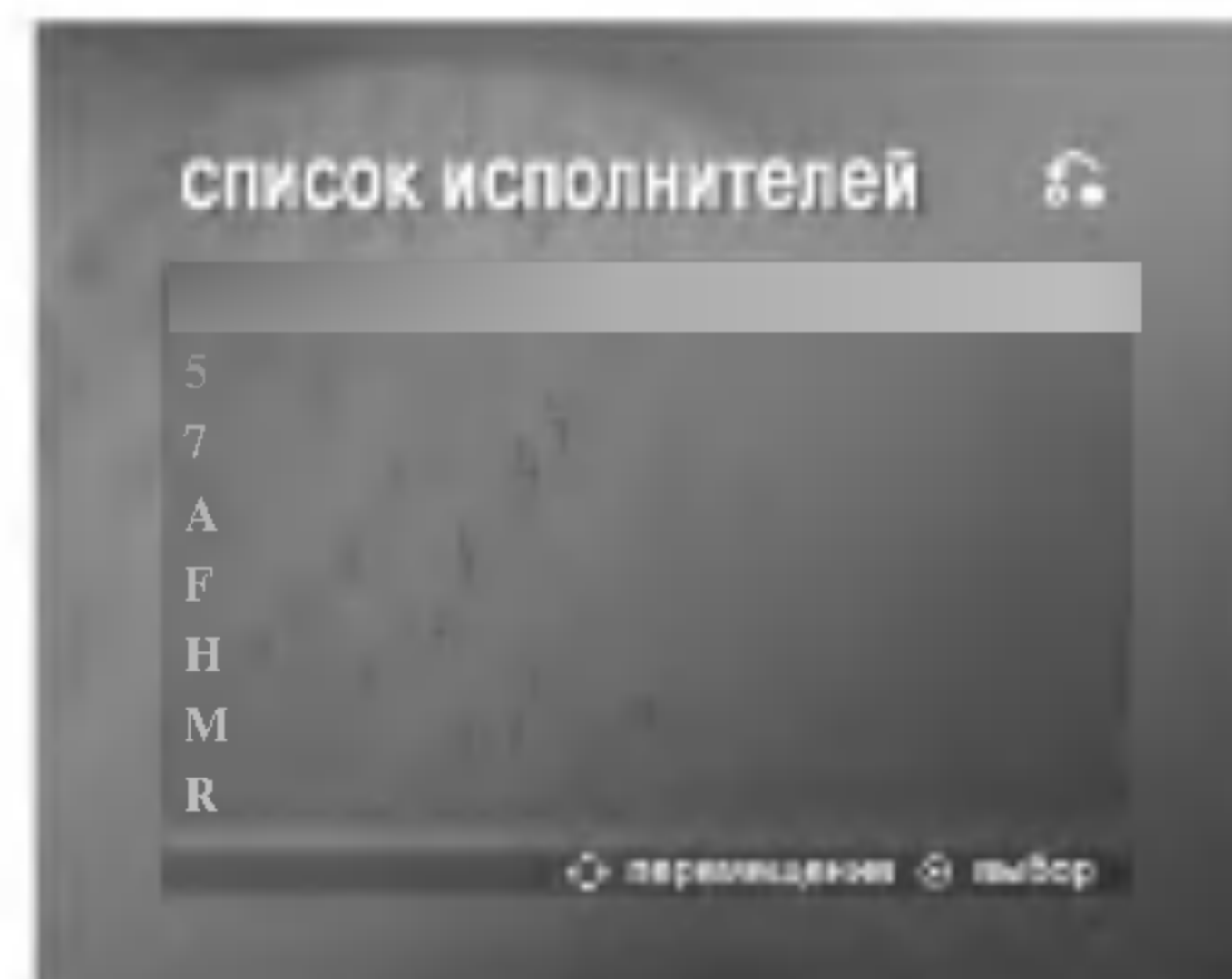

2 Select the singer you want by pressing the ▲ / ▼, and press SELECT/ ENTER.

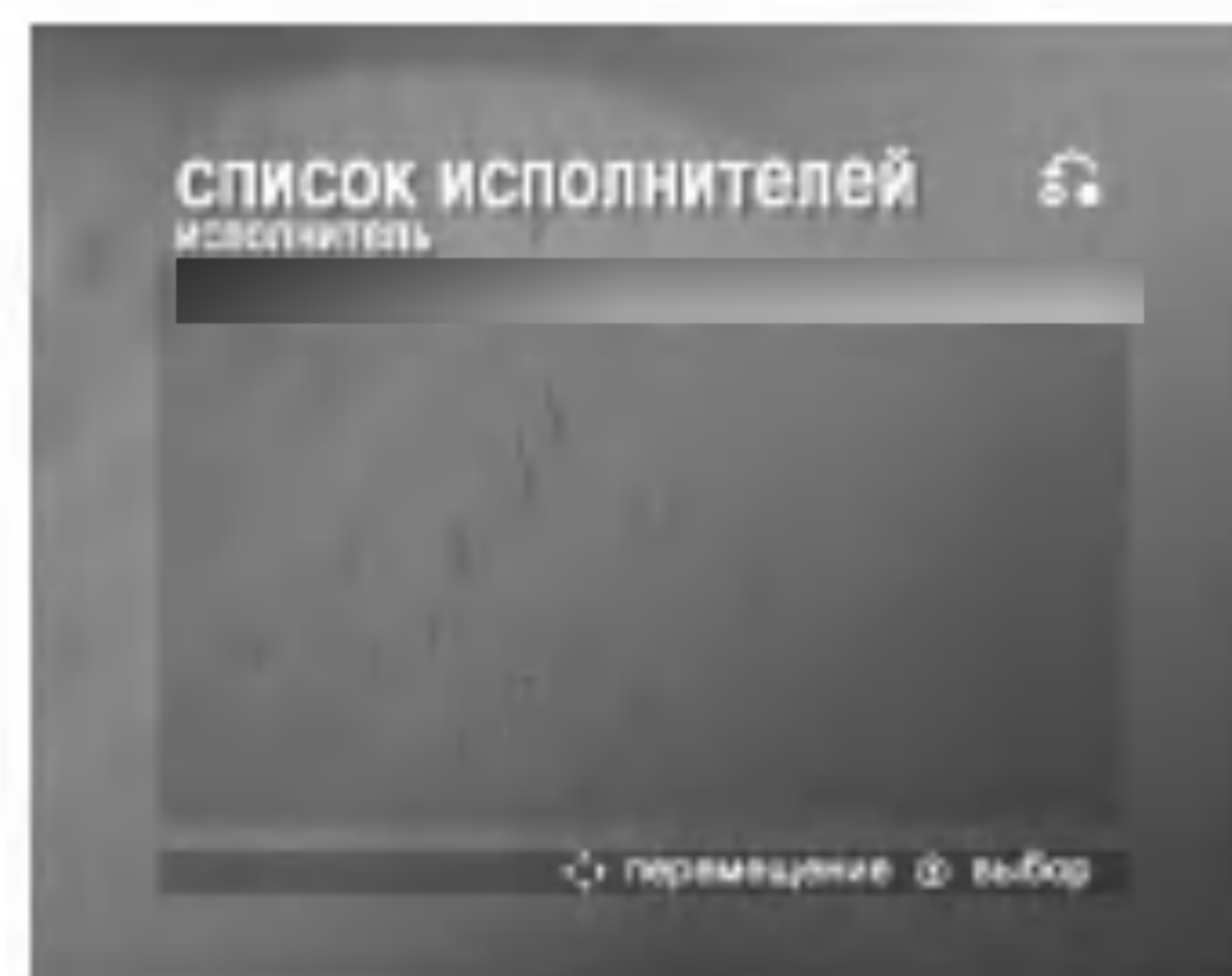

3 Select the song title of the singer you want by pressing the ▲ / ▼, and press SELECT/ ENTER.



Note

To move the previous mode, select the  by pressing the ▲ / ▼, then press SELECT/ ENTER.



CLASSIC (3. КЛАССИЧЕСКАЯ МУЗЫКА)

- 1** Select **3. КЛАССИЧЕСКАЯ МУЗЫКА** by pressing the **▲ / ▼**, and press **SELECT/ ENTER** in the **LOCAL SONG, POP SONG** and **CLASSIC** menu. The **CLASSIC LIST** and **COMPOSER LIST** menu will be shown on the TV screen.

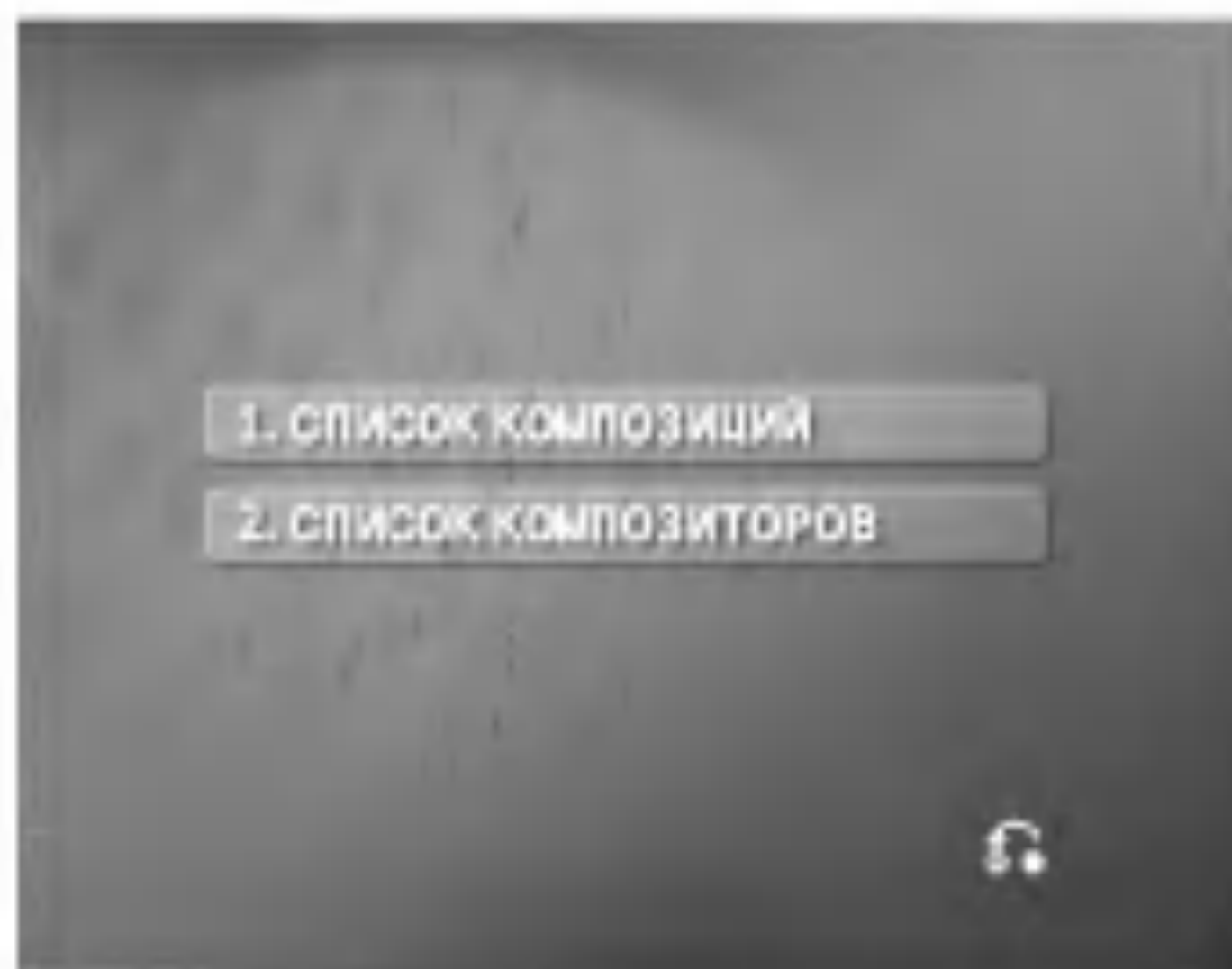

CLASSIC LIST (1. СПИСОК КОМПОЗИЦИЙ)

- 1** Select **1. СПИСОК КОМПОЗИЦИЙ** and select the initial of the song title you want by pressing the **▲ / ▼**, then press **SELECT/ ENTER**.

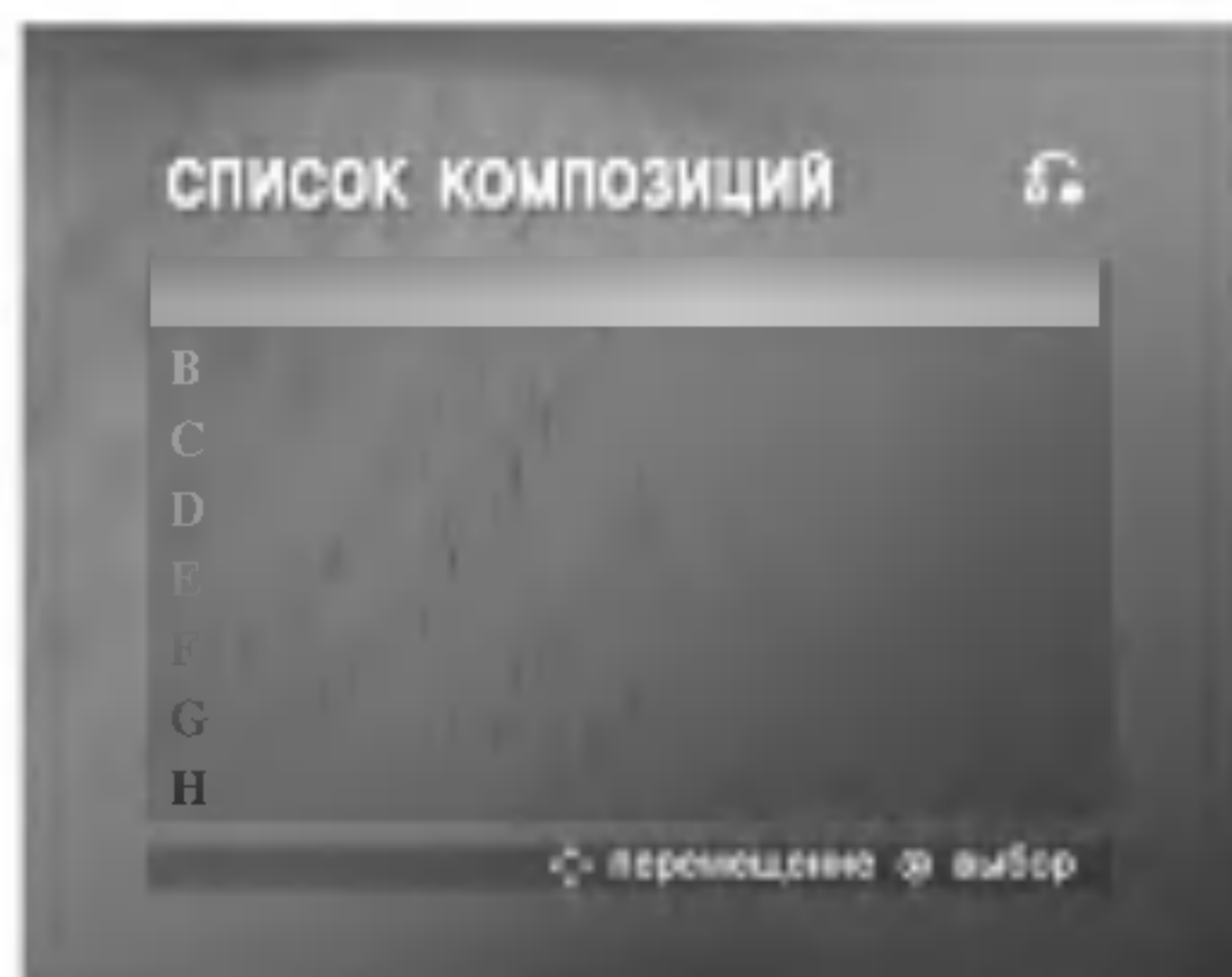

- 2** Select the song title you want by pressing the **▲ / ▼**, and press **SELECT/ ENTER**.



COMPOSER LIST (2. СПИСОК КОМПОЗИТОРОВ)

- 1** Select **2. СПИСОК КОМПОЗИТОРОВ** and select the initial of the composer you want by pressing the **▲ / ▼** in the **CLASSIC LIST** and **COMPOSER LIST** menu, and press **SELECT/ ENTER**.

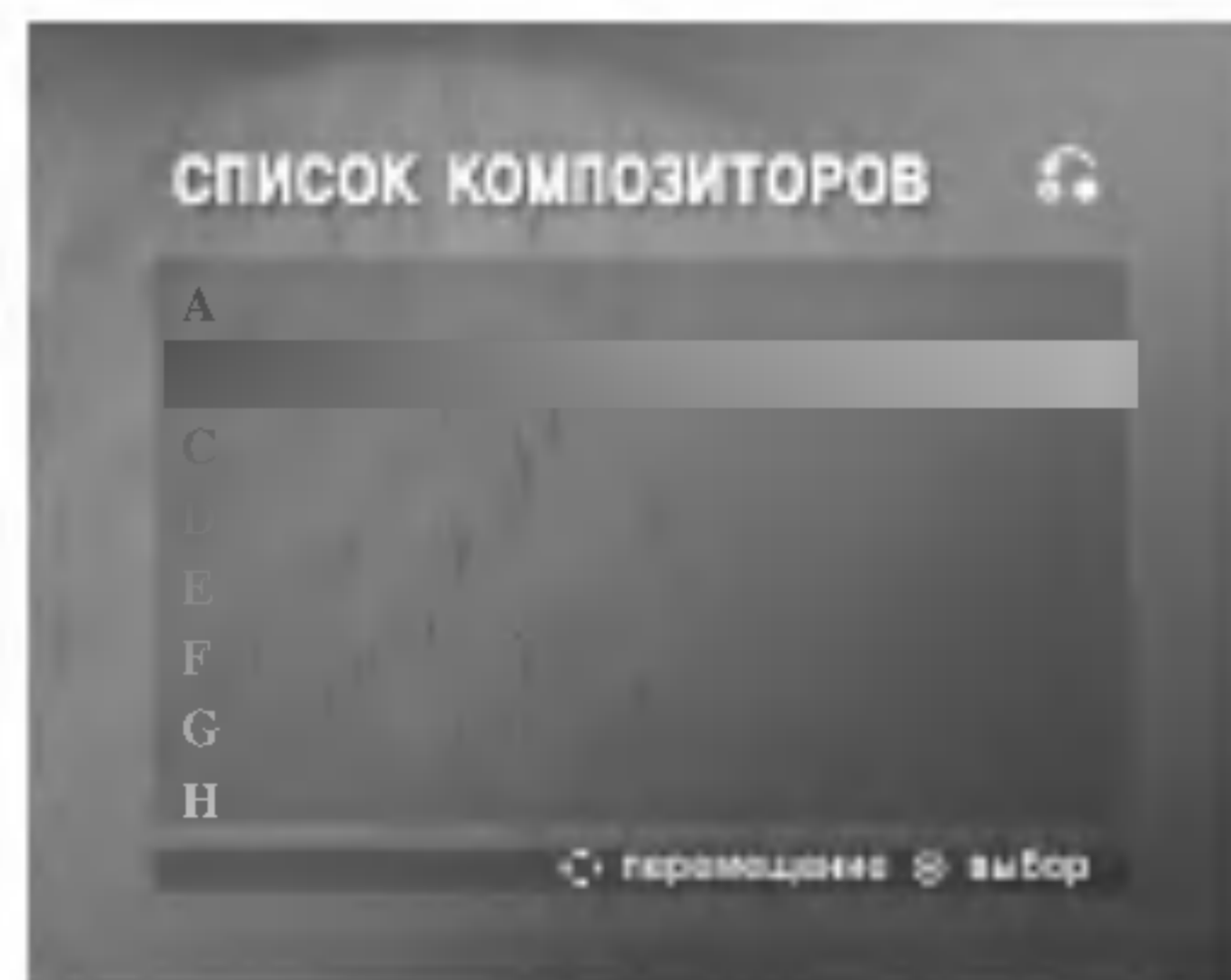

- 2** Select the composer you want by pressing the **▲ / ▼**, and press **SELECT/ ENTER**.

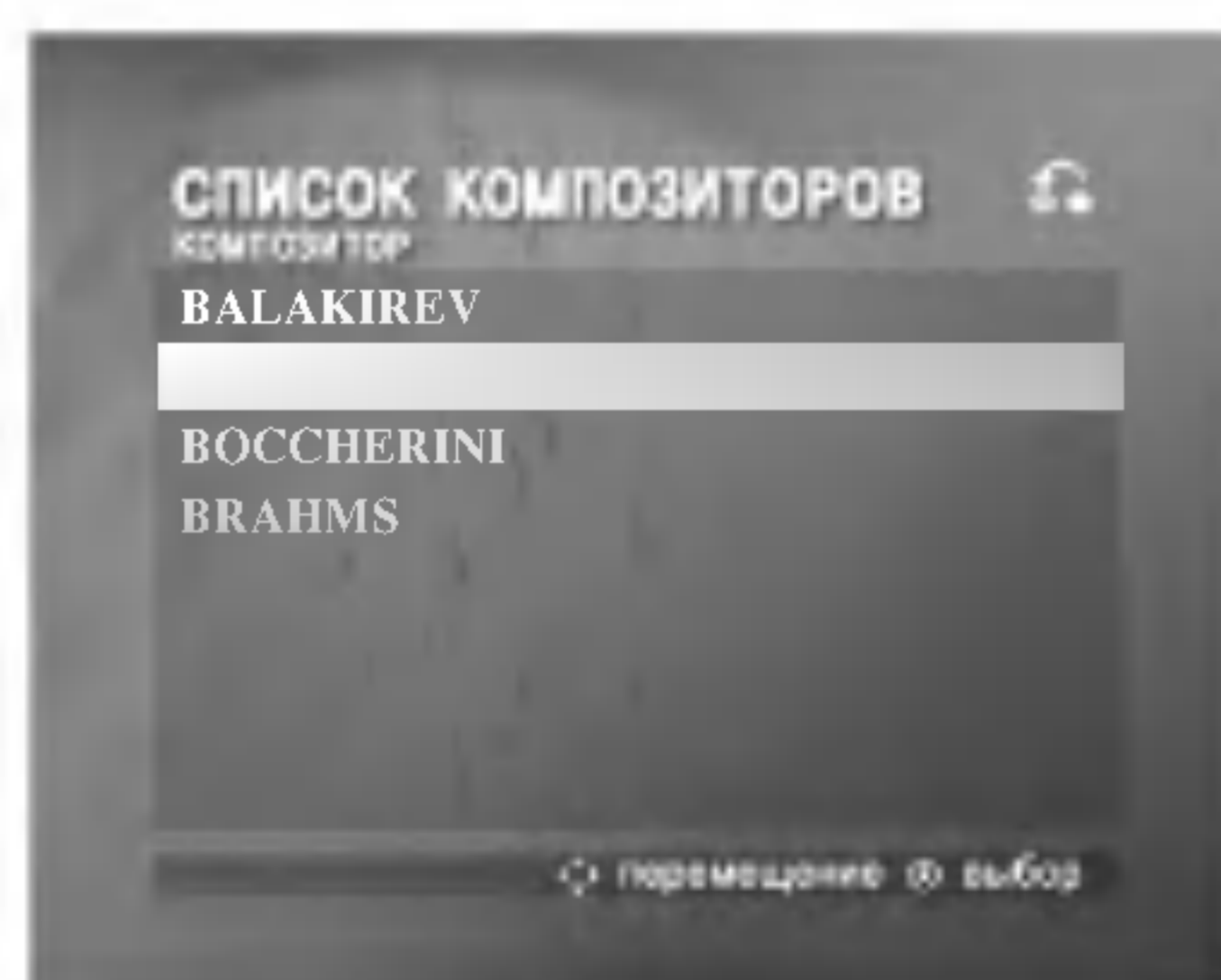

- 3** Select the song title of the composer you want by pressing the **▲ / ▼**, and press **SELECT/ ENTER**.



Note

To move the previous mode, select the  by pressing the **▲ / ▼**, then press **SELECT/ ENTER**.



RANDOM (случайный выбор)

- 1** Select **3. СЛУЧАЙНЫЙ ВЫБОР** by pressing **▲ / ▼** on the main menu.

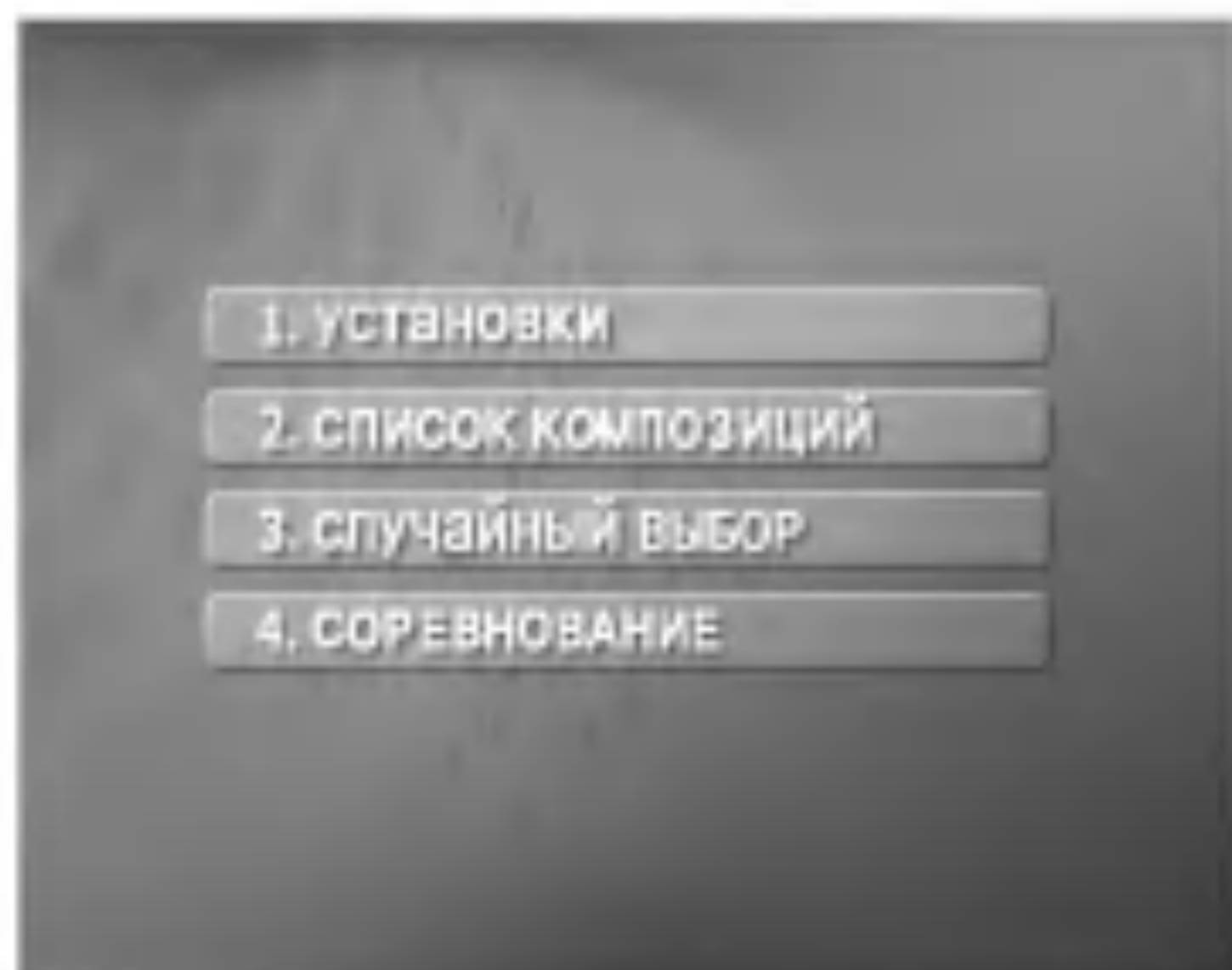

- 2** Press **SELECT/ENTER** to begin randomly.

CHALLENGE (СОРЕВНОВАНИЕ)

It has a function which enjoy a song game dividing by two teams of red team & blue team.

- 1** Select **4. СОРЕВНОВАНИЕ** by pressing **▲ / ▼** on the main menu.
It appears as below.

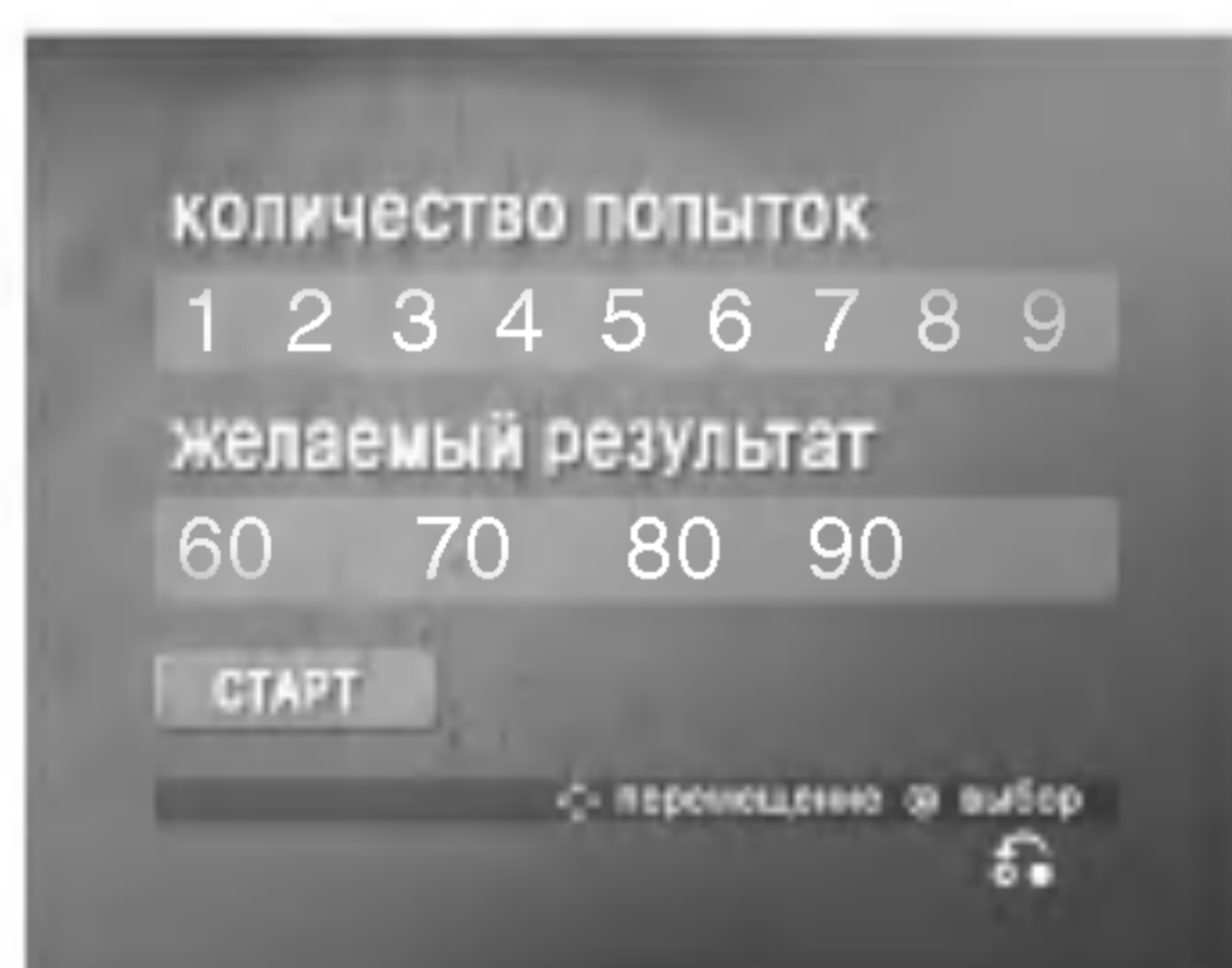

- 2** Select **КОЛИЧЕСТВО ПОПЫТОК** by pressing **▲ / ▼**, and select one of NUMERIC buttons 1~9 by pressing **◀ / ▶** to select winner's number, then press **SELECT/ENTER**.

- 3** Select **ЖЕЛАЕМЫЙ РЕЗУЛЬТАТ** by pressing **▲ / ▼**, and select one of 60,70,80 or 90 by pressing **◀ / ▶** to select success score, then press **SELECT/ENTER**.

- 4** Select **СТАРТ** by pressing **▲ / ▼**, then press **SELECT/ENTER**.
It appears as below.



- 5** Select number you want by pressing **▲ / ▼** and press **SELECT/ENTER**.
Sing along with the accompaniment.

- 6** Repeat step 4~5.
Change the team of red team or blue team alternately.

- 7** When reaching the targeted winning number, the **ПОЗДРАВЛЯЕМ** will be shown on the TV screen.
It appears as below.



- 8** Whether you keep going the song game or not, select **1. ДА** or **2. НЕТ** by pressing **▲ / ▼** as below.

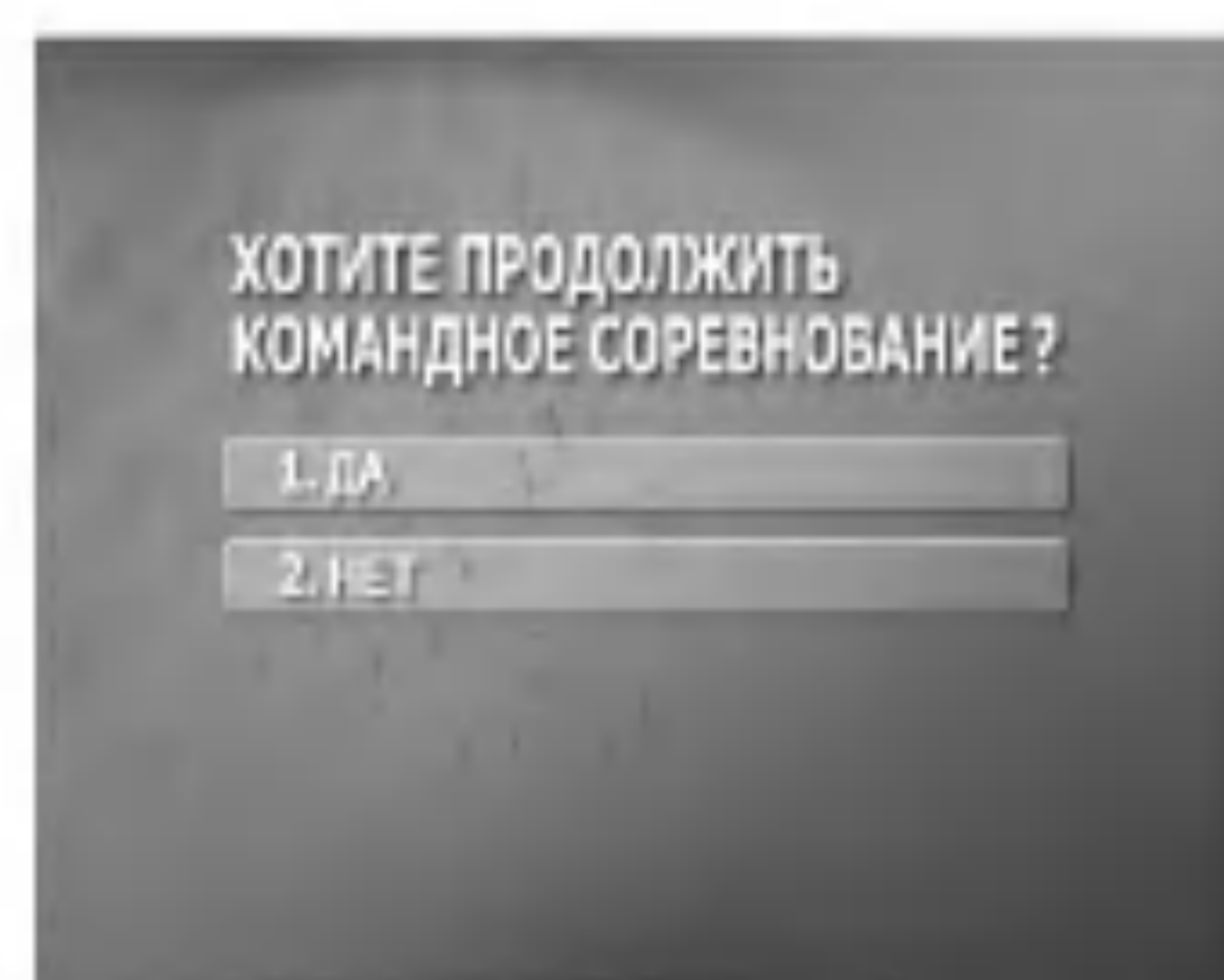



Check the following guide for the possible cause of a problem before contacting service.

Symptom	Cause	Correction
No power.	<ul style="list-style-type: none"> The power cord is disconnected. 	<ul style="list-style-type: none"> Plug the power cord into the wall outlet securely.
The power is on, but the unit does not work.	<ul style="list-style-type: none"> No disc is inserted. 	<ul style="list-style-type: none"> Insert a disc. (Check that the DVD or, audio CD indicator in the DVD display is lit.)
No picture.	<ul style="list-style-type: none"> The TV is not set to receive DVD signal output. 	<ul style="list-style-type: none"> Select the appropriate video input mode on the TV so the picture from the unit appears on the TV screen.
	<ul style="list-style-type: none"> The video cable is not connected securely. 	<ul style="list-style-type: none"> Connect the video cable into the jacks securely.
	<ul style="list-style-type: none"> The connected TV power is turned off. 	<ul style="list-style-type: none"> Turn on the TV.
There is no sound or only a very low-level sound is heard.	<ul style="list-style-type: none"> The equipment connected with the audio cable is not set to receive DVD signal output. 	<ul style="list-style-type: none"> Select the correct input mode of the audio so you can listen to the sound from the unit.
	<ul style="list-style-type: none"> The audio cables are not connected securely. 	<ul style="list-style-type: none"> Connect the audio cable into the jacks securely.
	<ul style="list-style-type: none"> The power of the equipment connected with the audio cable is turned off. 	<ul style="list-style-type: none"> Turn on the equipment connected with the audio cable.
	<ul style="list-style-type: none"> The audio connecting cord is damaged. 	<ul style="list-style-type: none"> Replace it with new one.
The playback picture is poor.	<ul style="list-style-type: none"> The disc is dirty. 	<ul style="list-style-type: none"> Clean the disc.
The unit does not start playback.	<ul style="list-style-type: none"> No disc is inserted. 	<ul style="list-style-type: none"> Insert a disc. (Check that the DVD, or audio CD indicator in the DVD display is lit.)
	<ul style="list-style-type: none"> An unplayable disc is inserted. 	<ul style="list-style-type: none"> Insert a playable disc. (Check the disc type, color system and Regional code.)
	<ul style="list-style-type: none"> The disc is placed upside down. 	<ul style="list-style-type: none"> Place the disc with the playback side down.
	<ul style="list-style-type: none"> The disc is not placed within the guide. 	<ul style="list-style-type: none"> Place the disc on the disc tray correctly inside the guide.
	<ul style="list-style-type: none"> The disc is dirty. 	<ul style="list-style-type: none"> Clean the disc.
	<ul style="list-style-type: none"> A menu is on the TV screen. 	<ul style="list-style-type: none"> Press the SET-UP button to turn off the menu screen.
Severe hum or noise is heard.	<ul style="list-style-type: none"> The plugs and jacks are dirty. 	<ul style="list-style-type: none"> Wipe them with a cloth slightly moistened with alcohol.
	<ul style="list-style-type: none"> The disc is dirty. 	<ul style="list-style-type: none"> Clean the disc.
	<ul style="list-style-type: none"> The speakers and components are connected poorly. 	<ul style="list-style-type: none"> Connect the speakers and components securely.
	<ul style="list-style-type: none"> The unit is located with too close to the TV. 	<ul style="list-style-type: none"> Move your TV away from the audio components.
Radio stations cannot be tuned in.	<ul style="list-style-type: none"> The antenna is positioned or connected poorly. 	<ul style="list-style-type: none"> Connect the antenna securely. Adjust the antennas and connect an external antenna if necessary.
	<ul style="list-style-type: none"> The signal strength of the stations is too weak (when tuning in with automatic tuning). 	<ul style="list-style-type: none"> Tune in the station manually.
	<ul style="list-style-type: none"> No stations have been preset or preset stations have been cleared (when tuning by scanning preset stations). 	<ul style="list-style-type: none"> Preset the stations.
The remote control does not work properly.	<ul style="list-style-type: none"> The remote control is not pointed at the remote sensor of the unit. 	<ul style="list-style-type: none"> Point the remote control at the remote sensor of the unit.
	<ul style="list-style-type: none"> The remote control is too far from the unit. 	<ul style="list-style-type: none"> Operate the remote control within about 23 ft (7 m).
	<ul style="list-style-type: none"> There is an obstacle in the path of the remote control and the unit. 	<ul style="list-style-type: none"> Remove the obstacle.
	<ul style="list-style-type: none"> The batteries in the remote control are exhausted. 	<ul style="list-style-type: none"> Replace the batteries with new ones.
The disc tray is not opened.	<ul style="list-style-type: none"> The DVD/KARAOKE function is not selected. 	<ul style="list-style-type: none"> Select the DVD/KARAOKE function by pressing the DVD/KARAOKE button. And then press the OPEN/CLOSE (▲) button.





Language Code List

Use this list to input your desired language for the following initial settings:
Disc Audio, Disc Subtitle, Disc Menu.

Language	Code	Language	Code	Language	Code	Language	Code
Abkhazian	6566	Finnish	7073	Macedonian	7775	Slovenian	8376
Afar	6565	French	7082	Malagasy	7771	Somali	8379
Afrikaans	6570	Galician	7176	Malay	7783	Spanish	6983
Albanian	8381	Georgian	7565	Malayalam	7776	Sudanese	8385
Ameharic	6577	German	6869	Maltese	7784	Swahili	8387
Arabic	6582	Greek	6976	Maori	7773	Swedish	8386
Armenian	7289	Greenlandic	7576	Marathi	7782	Tagalog	8476
Assamese	6583	Guarani	7178	Moldavian	7779	Tajik	8471
Azerbaijani	6590	Gujarati	7185	Mongolian	7778	Tamil	8465
Bashkir	6665	Hausa	7265	Nauru	7865	Tatar	8484
Basque	6985	Hebrew	7387	Nepali	7869	Telugu	8469
Bengali; Bangla	6678	Hindi	7273	Norwegian	7879	Thai	8472
Bhutani	6890	Hungarian	7285	Oriya	7982	Tibetan	6679
Bihari	6672	Icelandic	7383	Panjabi	8065	Tigrinya	8473
Breton	6682	Indonesian	7378	Pashto, Pushto	8083	Tonga	8479
Bulgarian	6671	Interlingua	7365	Persian	7065	Turkish	8482
Burmese	7789	Irish	7165	Polish	8076	Turkmen	8475
Byelorussian	6669	Italian	7384	Portuguese	8084	Twi	8487
Cambodian	7577	Japanese	7465	Quechua	8185	Ukrainian	8575
Catalan	6765	Javanese	7487	Rhaeto-Romance	8277	Urdu	8582
Chinese	9072	Kannada	7578	Rumanian	8279	Uzbek	8590
Corsican	6779	Kashmiri	7583	Russian	8285	Vietnamese	8673
Croatian	7282	Kazakh	7575	Samoan	8377	Volapük	8679
Czech	6783	Kirghiz	7589	Sanskrit	8365	Welsh	6789
Danish	6865	Korean	7579	Scots Gaelic	7168	Wolof	8779
Dutch	7876	Kurdish	7585	Serbian	8382	Xhosa	8872
English	6978	Laothian	7679	Serbo-Croatian	8372	Yiddish	7473
Esperanto	6979	Latin	7665	Shona	8378	Yoruba	8979
Estonian	6984	Latvian, Lettish	7686	Sindhi	8368	Zulu	9085
Faroese	7079	Lingala	7678	Singhalese	8373		
Fiji	7074	Lithuanian	7684	Slovak	8375		

Country Code List

Choose a country code from this list.

Country	Code	Country	Code	Country	Code	Country	Code
Afghanistan	AF	Ethiopia	ET	Malaysia	MY	Saudi Arabia	SA
Argentina	AR	Fiji	FJ	Maldives	MV	Senegal	SN
Australia	AU	Finland	FI	Mexico	MX	Singapore	SG
Austria	AT	France	FR	Monaco	MC	Slovak Republic	SK
Belgium	BE	Germany	DE	Mongolia	MN	Slovenia	SI
Bhutan	BT	Great Britain	GB	Morocco	MA	South Africa	ZA
Bolivia	BO	Greece	GR	Nepal	NP	South Korea	KR
Brazil	BR	Greenland	GL	Netherlands	NL	Spain	ES
Cambodia	KH	Heard and McDonald Islands	HM	Dutch Antilles	AN	Sri Lanka	LK
Canada	CA	Hong Kong	HK	New Zealand	NZ	Sweden	SE
Chile	CL	Hungary	HU	Nigeria	NG	Switzerland	CH
China	CN	India	IN	Norway	NO	Taiwan	TW
Colombia	CO	Indonesia	ID	Oman	OM	Thailand	TH
Congo	CG	Israel	IL	Pakistan	PK	Turkey	TR
Costa Rica	CR	Italy	IT	Panama	PA	Uganda	UG
Croatia	HR	Jamaica	JM	Paraguay	PY	Ukraine	UA
Czech Republic	CZ	Japan	JP	Philippines	PH	United States	US
Denmark	DK	Kenya	KE	Poland	PL	Uruguay	UY
Ecuador	EC	Kuwait	KW	Portugal	PT	Uzbekistan	UZ
Egypt	EG	Libya	LY	Romania	RO	Vietnam	VN
El Salvador	SV	Luxembourg	LU	Russian Federation	RU	Zimbabwe	ZW



General Section

Power supply	Refer to the main label.
Power consumption	90W
Mass	7.2kg
External dimensions (W x H x D)	170 x 340 x 300 mm

Tuner/Amplifier Section

FM Tuning Range	87.5 - 108.0 MHz or 65 -74 MHz, 87.5 -108.0 MHz
Intermediate Frequency	10.7 MHz
Signal to Noise Ratio	60/55 dB (Mono/Stereo)
Frequency Response	60 - 10000 Hz
AM Tuning Range	522 - 1611 kHz or 530 - 1610 kHz or 530 - 1720 kHz
Intermediate Frequency	450 kHz
Signal to Noise Ratio	35 dB
Frequency Response	100 - 2000 Hz
Output Power	30W + 30W (6Ω / 2ch THD 10 %)
T.H.D	0.15%
Frequency Response	40 - 20000 Hz
Signal-to-noise ratio	80 dB

Cassette tape player/DVD/VCD/CD player Section

DVD/VCD/CD player

Frequency response (audio)	40 - 18000 Hz
Signal-to-noise ratio (audio)	More than 70 dB (1 kHz)
Signal-to-noise ratio (video)	More than 60 dB (1 kHz)
Dynamic range (audio)	More than 70 dB
Video output	1.0 V (p-p), 75 Ω
S-video output	(Y) 1.0 V (p-p), 75 Ω (C) 0.3 V (p-p), 75 Ω
Component Video output	(Y) 1.0 V (p-p), 75 Ω, negative sync., RCA jack x 1 (Pb)/(Pr) 0.7 V (p-p), 75 Ω, RCA jack x 2

Cassette tape player

Tape Speed	3 kHz ± 3%
Wow Flutter	0.25% (MTT -111, JIS-WTD)
F.F/REW. Time	120sec (C-60)
Frequency Response	125 - 8000Hz
Signal to Noise Ratio	43dB(P/B)/43dB(R/B)
Channel Separation	50dB(P/B)/45dB(R/P)
Erase Ratio	55dB (MTT-5511)

Speaker Section

Speaker Name	Speaker (L/R)
Type	2 Way 2 Speaker
Impedance	6 Ω
Frequency Response	80 - 20000 Hz
Sound Pressure Level	85 dB/W (1m)
Rated Input Power	30 W
Max. Input Power	60 W
Net Dimensions (W x H x D)	200X340X208mm
Net Weight	2.9 kg

P/NO : 3834RH0114D