

ENGLISH

P7200 User Guide

Please read this manual carefully before operating
your mobile phone. Retain it for future reference.

CE 0168



P7200 User Guide



ISSUE 1.1
PRINTED IN KOREA

P/N : MMBB0188706



Disposal of your old appliance

1. When this crossed-out wheeled bin symbol is attached to a product it means the product is covered by the European Directive 2002/96/EC.
2. All electrical and electronic products should be disposed of separately from the municipal waste stream via designated collection facilities appointed by the government or the local authorities.
3. The correct disposal of your old appliance will help prevent potential negative consequences for the environment and human health.
4. For more detailed information about disposal of your old appliance, please contact your city office, waste disposal service or the shop where you purchased the product.



ENGLISH



P7200 User Guide

This manual may differ from the phone depending on the phone software version and service provider used.

Contents

Introduction	4	Contacts [Menu 2]	30
Guidelines for safe and efficient use	6	Search [Menu 2-1]	30
P7200 features	10	Add new [Menu 2-2]	30
Part of the phone	10	Caller groups [Menu 2-3]	31
Display Information	14	Speed dial [Menu 2-4]	31
On-Screen Icons	15	Own number [Menu 2-5]	31
Installation	16	My business card [Menu 2-6]	31
Installing the SIM card and the handset battery ..	16	Settings [Menu 2-7]	31
Charging the Battery	17	Organiser [Menu 3]	33
Disconnecting the charger	18	Calendar [Menu 3-1]	33
Memory card	18	Memo [Menu 3-2]	34
Inserting the memory card	18	Multimedia [Menu 4]	35
Removing the memory card	18	Camera [Menu 4-1]	35
Memory card formatting	19	Video camera [Menu 4-2]	37
Memory card adapter	19	Voice recorder [Menu 4-3]	37
General Functions	20	MP3 [Menu 4-4]	38
Making a Call	20	Photo album [Menu 4-5]	40
Adjusting the Volume	20	Video album [Menu 4-6]	41
Answering a Call	20	Settings [Menu 4-7]	41
Entering Text	21	Messages [Menu 5]	42
Selecting Functions and Options	24	New message [Menu 5-1]	42
In-Call Menu	25	Inbox [Menu 5-2]	45
During a Call	25	Mailbox [Menu 5-3]	46
Conference Calls	26	Drafts [Menu 5-4]	46
Menu Tree	27	Outbox [Menu 5-5]	46
Games & Apps [Menu 1]	29	Listen to voice mail [Menu 5-6]	47
Games & Apps [Menu 1-1]	29	Info message [Menu 5-7]	47
Profiles [Menu 1-2]	29	Templates [Menu 5-8]	48
		Settings [Menu 5-9]	48

My stuff [Menu 6]	52	Browser [Menu *]	63
Videos [Menu 6-1]	52	Home [Menu *-1]	63
Photos [Menu 6-2]	52	Bookmarks [Menu *-2]	63
Music [Menu 6-3]	53	Go to URL [Menu *-3]	64
Text [Menu 6-4]	53	Settings [Menu *-4]	64
Images [Menu 6-5]	54	Call register [Menu 0]	66
Sounds [Menu 6-6]	54	Missed calls [Menu 0-1]	66
Others [Menu 6-7]	55	Received calls [Menu 0-2]	66
Games & Apps [Menu 6-8]	55	Dialled calls [Menu 0-3]	66
External Memory [Menu 6-9]	55	All calls [Menu 0-4]	66
Display [Menu 7]	57	Delete recent calls [Menu 0-5]	66
Wallpaper [Menu 7-1]	57	Call charges [Menu 0-6]	67
Menu Colour [Menu 7-2]	57	GPRS information [Menu 0-7]	67
Standby text [Menu 7-3]	57	Settings [Menu #]	68
Backlight [Menu 7-4]	57	Date & Time [Menu #-1]	68
Network name [Menu 7-5]	57	Language [Menu #-2]	68
Profiles [Menu 8]	58	Call [Menu #-3]	68
Activate [Menu 8-X-1]	58	Security [Menu #-4]	70
Personalise [Menu 8-X-2]	58	Network [Menu #-5]	72
Rename [Menu 8-X-3]	59	GPRS Attach [Menu #-6]	73
Tools [Menu 9]	60	Memory status [Menu #-7]	73
Favourites [Menu 9-1]	60	Reset settings [Menu #-8]	73
Alarm clock [Menu 9-2]	60	Accessories	74
Bluetooth [Menu 9-3]	60	Technical Data	75
Modem [Menu 9-4]	61		
Calculator [Menu 9-5]	61		
Unit converter [Menu 9-6]	62		
World time [Menu 9-7]	62		
SIM-Menu [Menu 9-8]	62		

Congratulations on your purchase of the advanced and compact P7200 cellular phone, designed to operate with the latest digital mobile communication technology.



This user's guide contains important information on the use and operation of this phone. Please read all the information carefully for optimal performance and to prevent any damage to or misuse of the phone. Any changes or modifications not expressly approved in this user's guide could void your warranty for this equipment.

Use of phone cases with magnetic locks with folder type phones has caused problems such as loss of network signal and phones powering off.

Please read these simple guidelines. Not following these guidelines may be dangerous or illegal. Further detailed information is given in this manual.

Warning

- Mobile Phones must be switched off at all times in aircrafts.
- Do not hold the phone in your hand while driving.
- Do not use your phone near petrol stations, fuel depots, chemical plants or blasting operations.
- For your safety, use ONLY specified ORIGINAL batteries and chargers.
- Do not handle the phone with wet hands while it is being charged. It may cause an electric shock or seriously damage your phone.
- Keep the phone in a safe place out of small children's reach. It includes small parts which, if detached, may cause a choking hazard.

Caution

- Switch off the phone in any area where required by special regulations. For example, do not use your phone in hospitals or it may affect sensitive medical equipment.
- Emergency calls may not be available under all mobile networks. Therefore, you should never depend solely on your mobile phone for emergency calls.
- Only use ORIGINAL accessories to avoid damage to your phone.
- All radio transmitters carry risks of interference with electronics in close proximity. Minor interference may affect TVs, radios, PCs, etc.
- Batteries should be disposed of in accordance with relevant legislation.
- Do not dismantle the phone or battery.

Guidelines for safe and efficient use

Radio wave exposure and Specific Absorption Rate (SAR) information

This mobile phone model P7200 has been designed to comply with applicable safety requirement for exposure to radio waves. This requirement is based on scientific guidelines that include safety margins designed to assure the safety of all persons, regardless of age and health.

- The radio wave exposure guidelines employ a unit of measurement known as the Specific Absorption Rate, or SAR. Tests for SAR are conducted using standardized methods with the phone transmitting at its highest certified power level in all used frequency bands.
- While there may be differences between the SAR levels of various LG phone models, they are all designed to meet the relevant guidelines for exposure to radio waves.
- The SAR limit recommended by the international Commission on Non-Ionizing Radiation Protection (ICNIRP), which is 2W/kg averaged over ten (10) gram of tissue.
- The highest SAR value for this model phone tested by DAS4 for use at the ear is 0.366 W/kg (10g).
- SAR data information for residents in countries/

regions that have adopted the SAR limit recommended by the Institute of Electrical and Electronics Engineers (IEEE), which is 1.6 W/kg averaged over one (1) gram of tissue.

Product care and maintenance

⚠ Warning

Use only batteries, chargers and accessories approved for use with this particular phone model. The use of any other types may invalidate any approval or warranty applying to the phone, and may be dangerous.

- Do not disassemble this unit. Take it to a qualified service technician when repair work is required.
- Keep away from electrical appliances such as a TV, radio or personal computer.
- The unit should be kept away from heat sources such as radiators or cookers.
- Do not drop.
- Do not subject this unit to mechanical vibration or shock.
- The coating of the phone may be damaged if covered with wrap or vinyl wrapper.
- Do not use harsh chemicals (such as alcohol, benzene, thinners, etc.) or detergents to clean your phone. There is a risk of this causing a fire.

- Do not subject this unit to excessive smoke or dust.
- Do not keep the phone next to credit cards or transport tickets; it can affect the information on the magnetic strips.
- Do not tap the screen with sharp objects as, it may damage the phone.
- Do not expose the phone to liquid or moisture.
- Use the accessories like an earphone cautiously.
- If you put your phone in a pocket or bag without covering the receptacle of the phone (power plug pin), metallic articles (such as a coin, paperclip or pen) may short-circuit the phone. Always cover the receptacle when not in use.
- Never place your phone in a microwave oven as it will cause the battery to explode.
- Only authorized personnel should service the phone and its accessories. Faulty installation or service may result in accidents and consequently invalidate the warranty.
- Do not use the phone if the antenna is damaged. If a damaged antenna contacts skin, it may cause a slight burn. Please contact an LG Authorized Service Centre to replace the damaged antenna.
- The label on the phone contains important

information for customer support purposes. Do not remove it.

Efficient phone operation

To enjoy optimum performance with minimum power consumption please:

- Hold the phone as you speak to any other telephone. While speaking directly into the microphone, angle the antenna in a direction up and over your shoulder. If the antenna is extendable/retractable, it should be extended during a call.
- Do not hold the antenna when the phone is in use. If you hold it, it can affect call quality, it also may cause the phone to operate as a higher power level than needed and shorten talk and standby times.
- If your mobile phone supports infrared, never direct the infrared ray at anyone's eyes.

Electronics devices

All mobile phones may get interference, which could affect performance.

- Do not use your mobile phone near medical equipment without requesting permission. Avoid placing the phone over pacemakers, (i.e. in your breast pocket).

Guidelines for safe and efficient use

- Some hearing aids might be disturbed by mobile phones.
- Minor interference may affect TVs, radios, PCs, etc.
- Do not bend, scratch, or expose to static electricity.

Road safety

Check the laws and regulations on the use of mobile phones in the areas when you drive.

- Do not use a hand-held phone while driving.
- Give full attention to driving.
- Use a hands-free kit, if available.
- Pull off the road and park before making or answering a call if driving conditions so require.
- RF energy may affect some electronic systems in your motor vehicle such as a car stereo or safety equipment.
- When riding in a car, do not leave your phone or set up the hands-free kit near to the air bag. If wireless equipment is improperly installed and the air bag is activated, you may be seriously injured.

Blasting area

Do not use the phone where blasting is in progress. Observe restrictions, and follow any regulations or rules.

Potentially explosive atmospheres

- Do not use the phone at a refueling point. Don't use near fuel or chemicals.
- Do not transport or store flammable gas, liquid, or explosives in the compartment of your vehicle, which contains your mobile phone and accessories.

In aircraft

Wireless devices can cause interference in aircraft.

- Turn off your mobile phone before boarding any aircraft.
- Do not use it on the ground without crew permission.

Battery information and care

- You do not need to completely discharge the battery before recharging. Unlike other battery systems, there is no memory effect that could compromise the battery's performance.
- Use only LG batteries and chargers. LG chargers are designed to maximize the battery life.
- Do not disassemble or short-circuit the battery pack.
- Keep the metal contacts of the battery pack clean.

- Replace the battery when it no longer provides acceptable performance. The battery pack may be recharged hundreds of times until it needs replacing.
- Recharge the battery if it has not been used for a long time to maximize usability.
- Do not expose the battery charger to direct sunlight or use it in high humidity, such as the bathroom.
- Do not leave the battery in hot or cold places, this may deteriorate the battery performance.

Memory card information and care

- Always insert/remove the memory card while the handset power is off. If you remove it on writing application, it may be damaged.
- If corrupted, format the memory card.
- The memory card cannot be used for recording copyright-protected data.
- Do not press hard when writing on the card.
- Carry and store the memory card in its case.
- Do not allow the memory card to get wet.
- Do not leave the memory card in extremely hot locations.

- Do not disassemble or modify the memory card.

Network service

- Some services and functions described in this user's guide are dependent on network or subscription. Therefore, all menus may not be available in your phone. Please consult your network operator for more information about your subscription.

For optimal call performance, please do not obstruct the internal antenna.

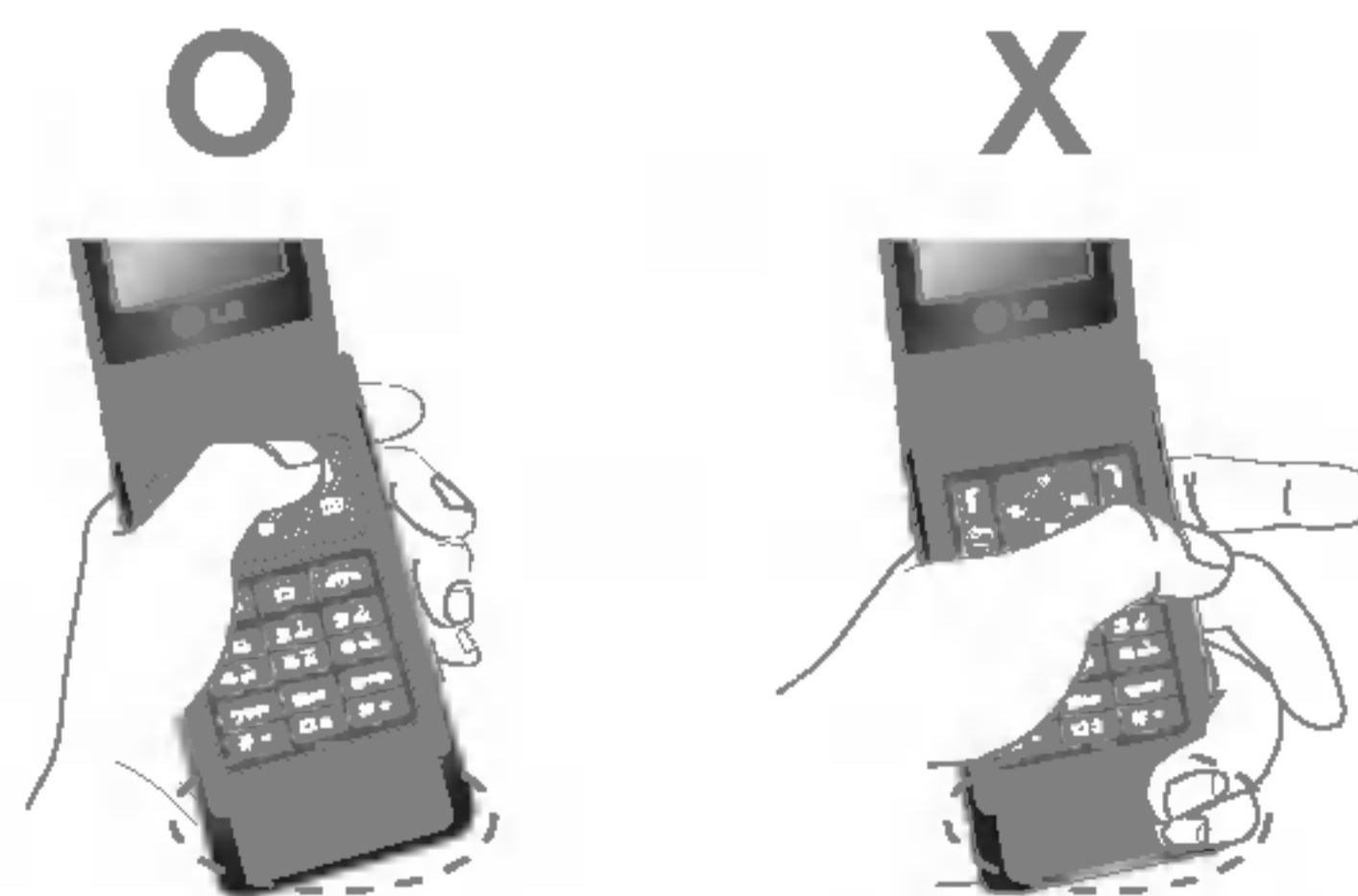

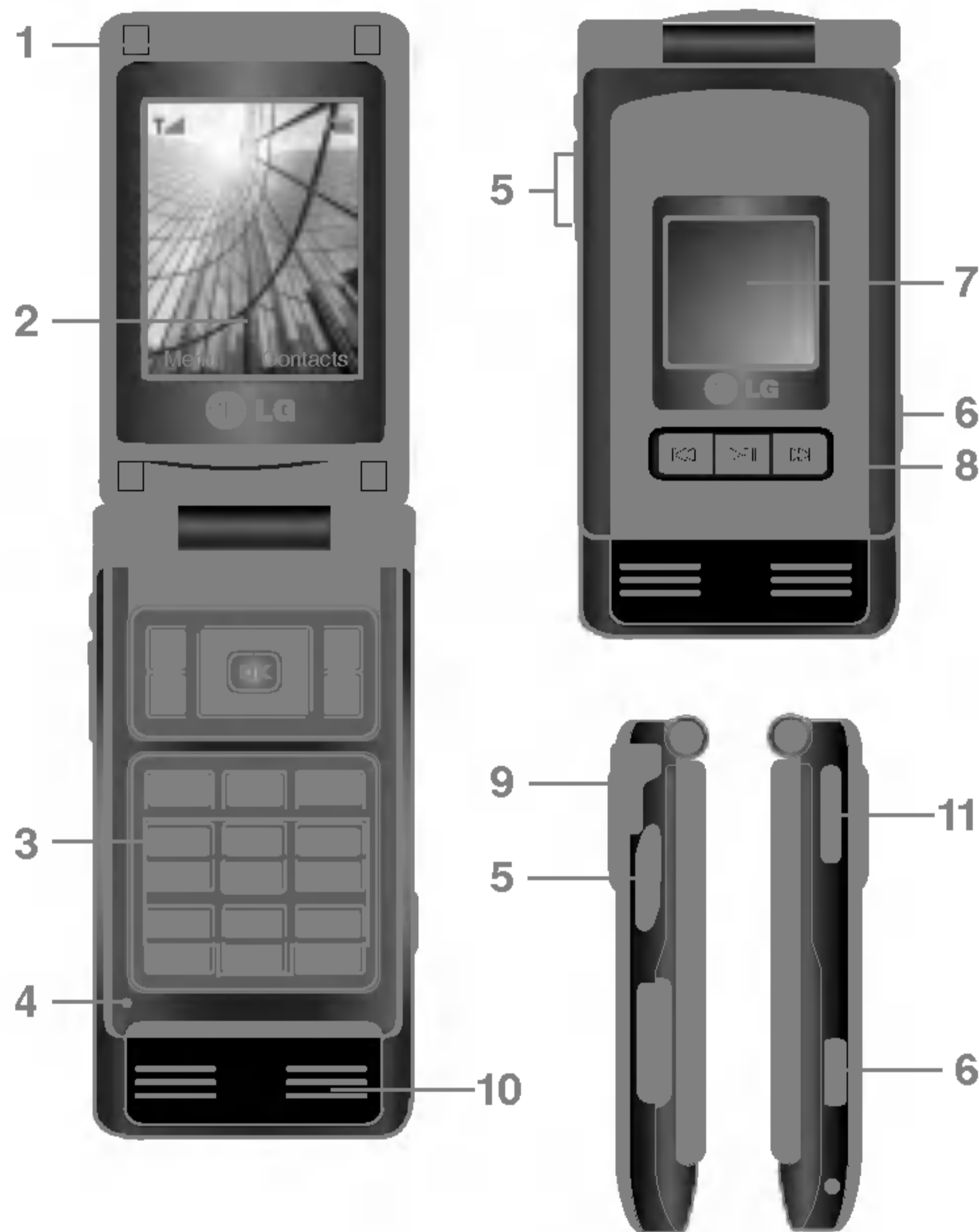





Part of the phone

1. Earpiece

2. Main LCD

- **Top:** Icons showing signal strength, battery level and various other functions.
- **Bottom:** Soft key indications

3. Alpha numeric keys

- **In standby mode:** Input numbers to dial. Hold down
 -  - International calls
 -  - Dial Voice mail centre.
 -  to  - Speed dials
- **In editing mode:** Enter numbers & characters

4. Microphone

5. Side keys

- **In standby mode (opened):** Volume of key tone
- **In standby mode (closed):**
 - Short press** - The sub LCD light on.
 - Long press** - Only display a wallpaper.
- **In menu:** scroll up & down
- **During a call:** volume of the earpiece

! Note To protect the sense of hearing while Folder open, maximum volume level is 3.

6. Multimedia hot key

Long press - photo camera activation(Folder opened)

Short press - Camera and MP3 menu access

7. Sub LCD

8. MOD key

9. Memory card slot

10. Internal loudspeaker

- Listen to MP3 player without headphones
- Used when speaker phone is activated.

11. Handsfree slot

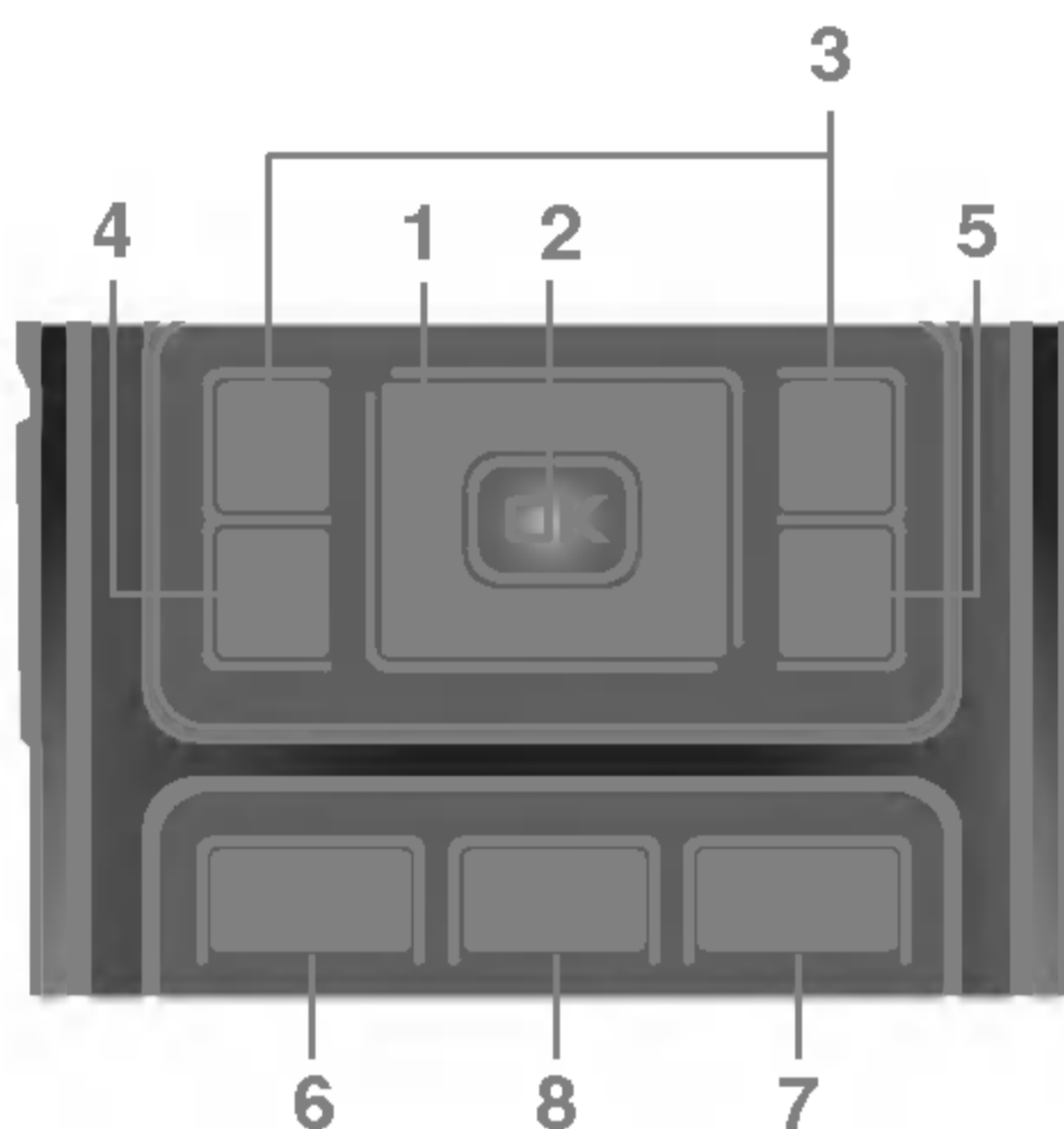

1. Navigation key

- **In standby mode:**

-  **Briefly:** List of Favourites

-  **Briefly:** List of Contacts

-  **Briefly:** List of Profiles
(**Hold down:** Activate/Deactivate Vibrate mode)

-  **Briefly:** List of Messages

- **In menu:** scroll up & down

2. Confirm key

3. Soft keys

- These keys perform the function indicated in the bottom of the display.

4. Scheduler hot key

- Activate the Scheduler menu directly.

5. Camera and Multimedia hot key

- Activates the camera (long press) and Multimedia menu (short press) directly.

6. Send key

- Dial a phone number and answer a call.
- **In standby mode:** shows a history of calls made, received, and missed.

7. End key

- Switch on/off (hold down)
- End or reject a call.

8. Clear key

Rear view

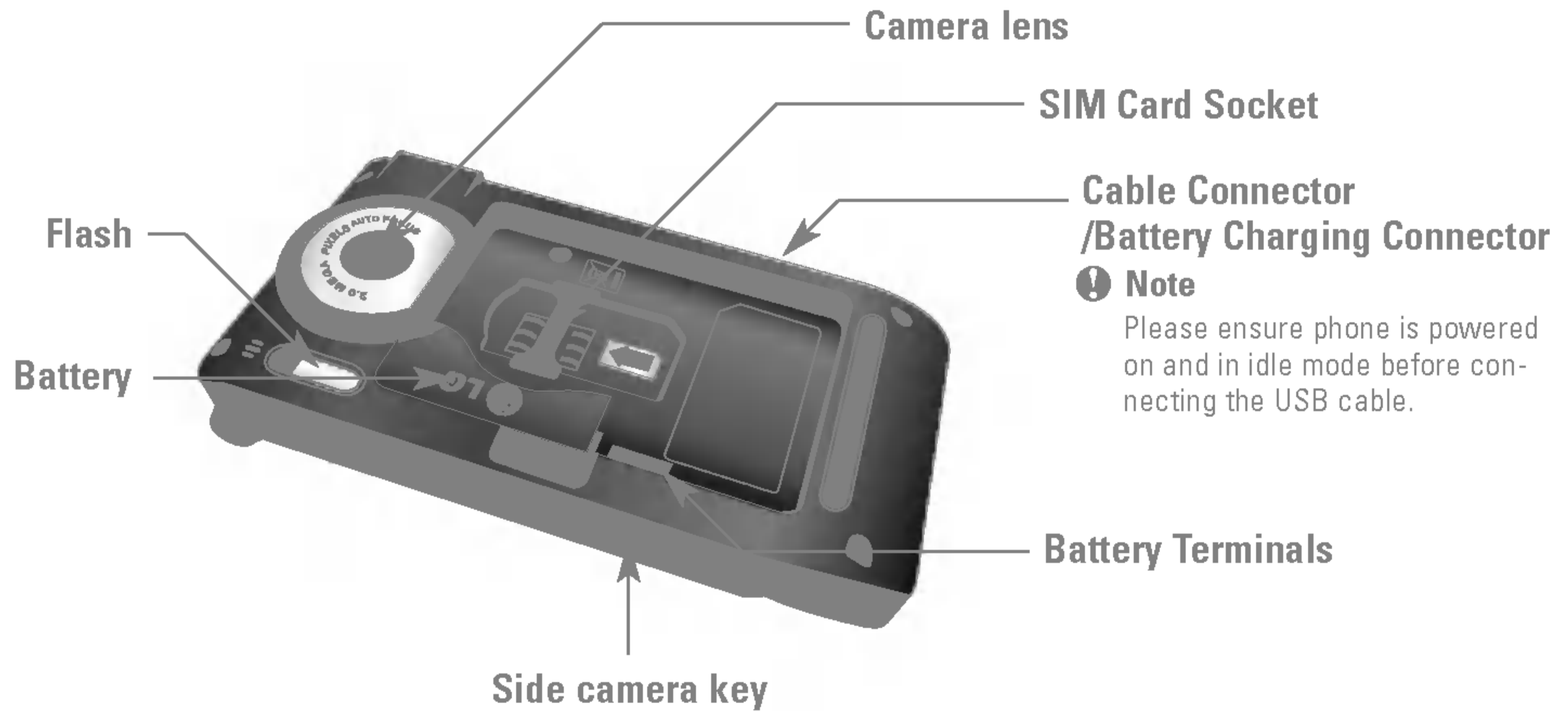



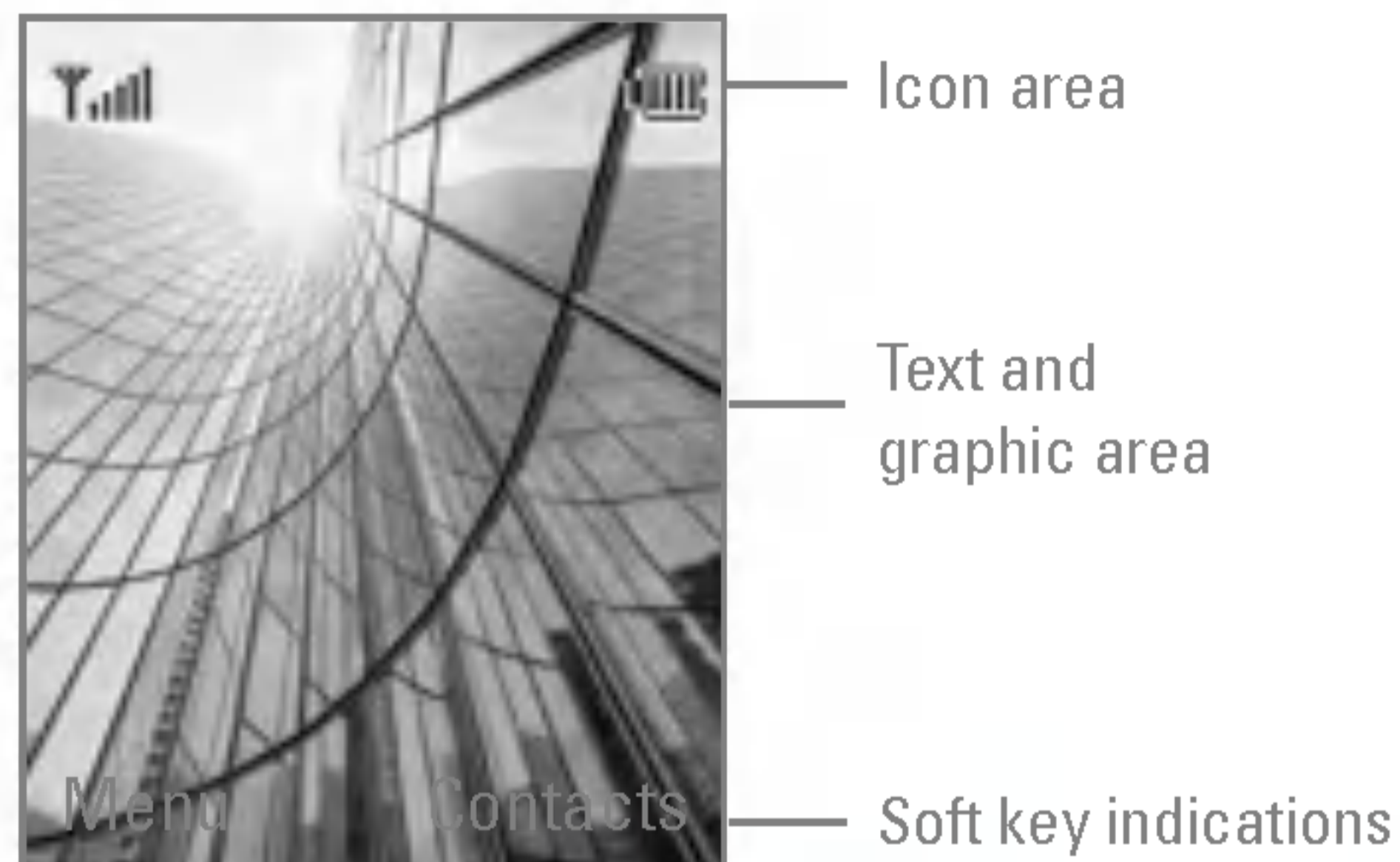





Display Information











	Description
First line	Displays various icons. See page 15.
Middle lines	Display messages, instructions and any information that you enter, such as number to be dialed.
Last line	Shows the functions currently assigned to the two soft keys.

The screen displays several icons. These are described below.

On-Screen Icons

Icon/Indicator	Description
	Tells you the strength of the network signal.
	Call is connected.
	You can use GPRS service.
	Shows that you are using a roaming service.
	The alarm has been set and is on.
	Tells you the status of the battery.
	You have received a text message.
	You have received a voice message.

Note The quality of the conversation may change depending on network coverage. When the signal strength is below 2 bars, you may experience muting, call drop and poor audio. Please refer to this signal as an indicator for your calls. When there are no bars, that means that there is no network coverage: in this case, you won't be able to access the network for any service (call, messages and so on).

	Description
	Vibrate only menu in profile.
	General menu in profile.
	Loud menu in profile.
	Silent menu in profile.
	Headset menu in profile.
	You can divert a call.
	Indicates that the phone is accessing the WAP.
	Indicates that you are using GPRS.
	You have activated Bluetooth menu.

Installing the SIM card and the handset battery

Make sure the power is off before you remove the battery.

1. Remove the battery.

Hold the top edge of the battery and lift the battery from the battery compartment.



2. Install the SIM card.

Insert the SIM card into the holder. Slide the SIM card into the SIM card holder. Make sure that the SIM card is inserted properly and that the gold contact area on the card is facing downwards. To remove the SIM card, press down lightly and pull it in the reverse direction.

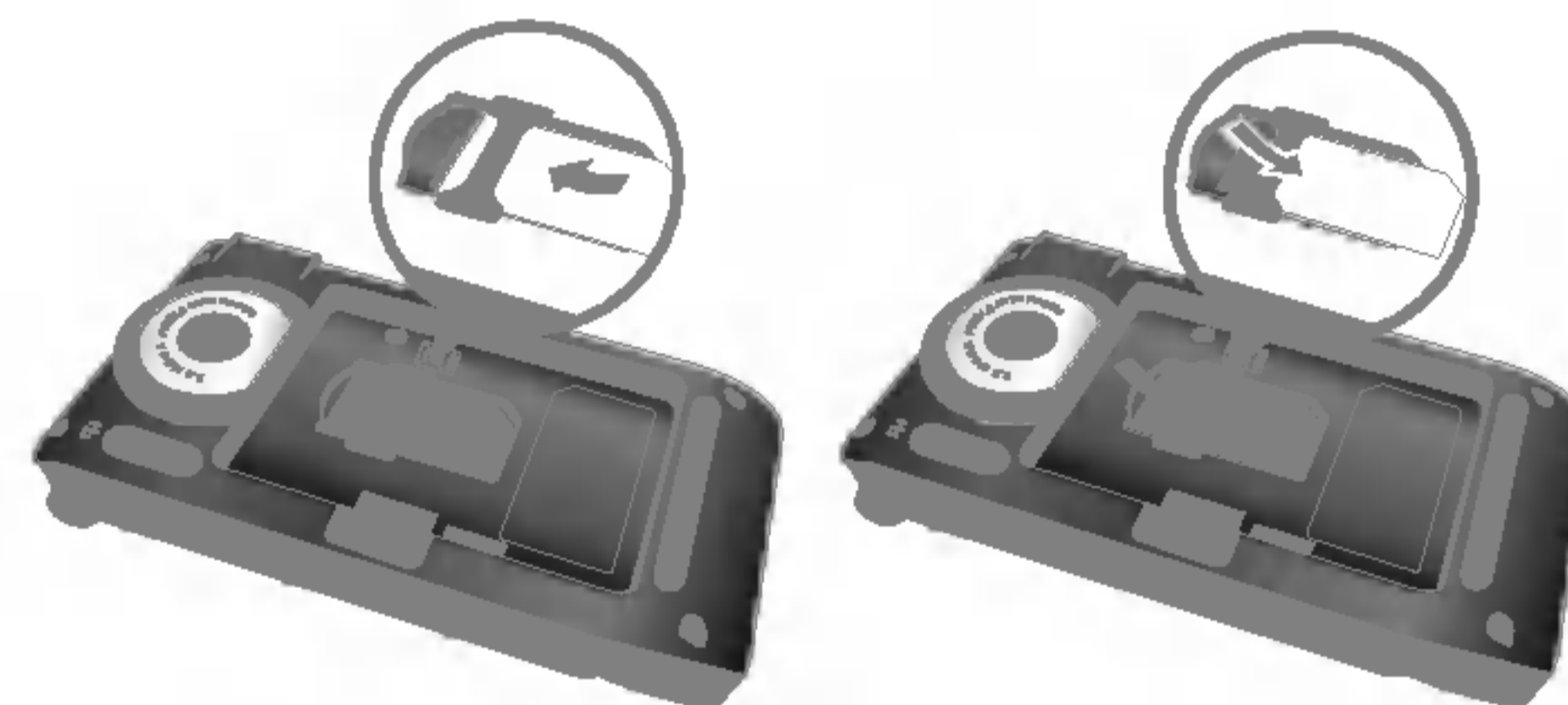

To insert the SIM card

To remove the SIM card

! Note The metal contact of the SIM card can be easily damaged by scratches. Pay special attention to the SIM card while handling. Follow the instructions supplied with the SIM card.

3. Install the battery.

Insert the bottom of the battery first into the bottom edge of the battery compartment. Push down the top of the battery until it snaps into space.

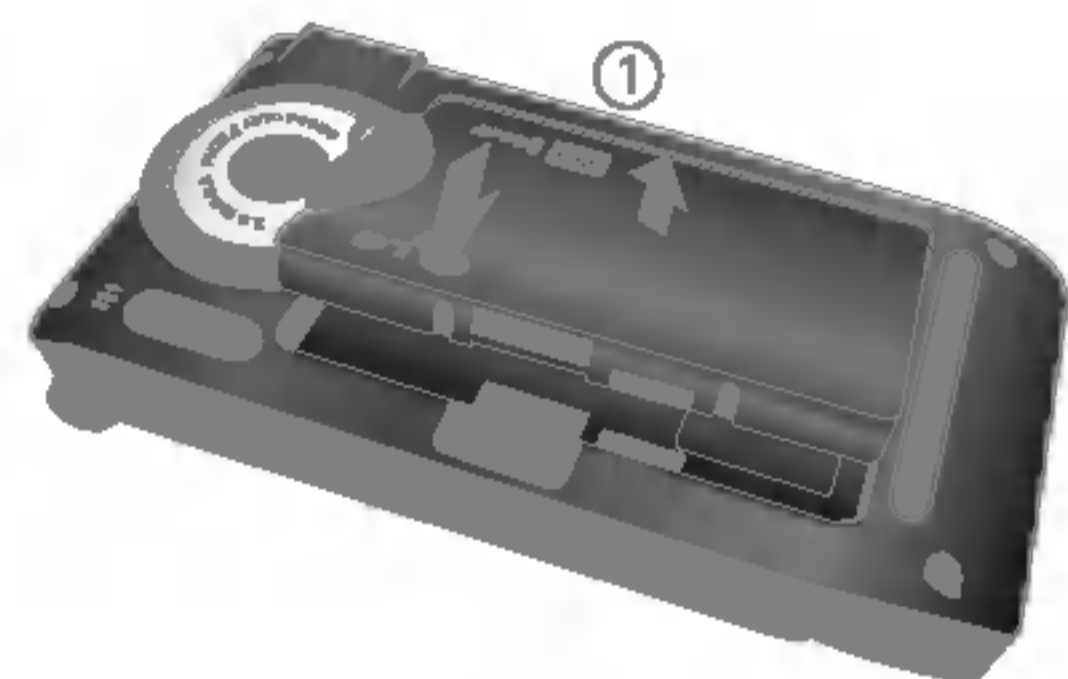

Charging the Battery

Before connecting the travel adapter to the phone you must first install the battery.

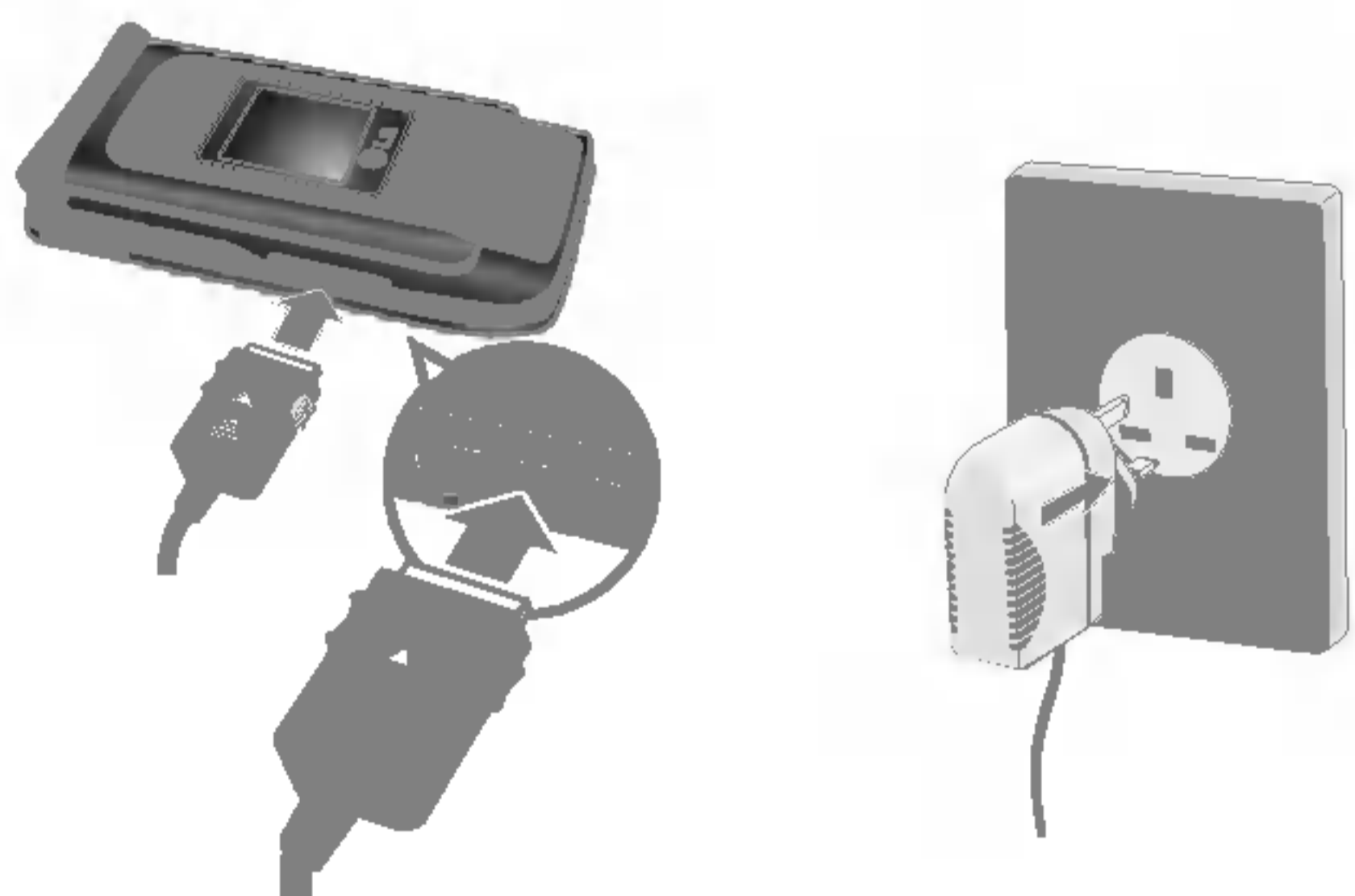

1. Ensure the battery is fully charged before using the phone for the first time.

2. With the arrow facing you as shown in the diagram push the plug on the battery adapter into the socket on the side of the phone until it clicks into place.

3. Connect the other end of the travel adapter to the mains socket. Use only the charger included in the box.

4. The moving bars of battery icon will stop after charging is complete.

! Caution • Do not force the connector as this may damage the phone and/or the travel adapter.

- If you use the battery pack charger out of your own country, use an attachment plug adaptor for the proper configuration.

- Do not remove your battery or the SIM card while charging.

! Warning • Unplug the power cord and charger during lightning storms to avoid electric shock or fire.

- Make sure that no sharp-edged items such as animal teeth or nails, come into contact with the battery. There is a risk of this causing a fire.

- Do not place or answer calls while charging the phone as it may short-circuit the phone and/or cause electric shock or fire.

Disconnecting the charger

Disconnect the travel adapter from the phone by pressing its side buttons as shown in the diagram.



Memory card

The P7200 is equipped with a slot on the side for a memory card with a maximum of 128MB capacity. You can use this card to save data files such as photos, video, audio, contact point, schedule.

Note Always insert/remove the memory card with the handset power off.

Inserting the memory card

Insert the memory card into the slot until the memory card is fully inserted into the slot, as shown in the figure below:



Open the memory card slot

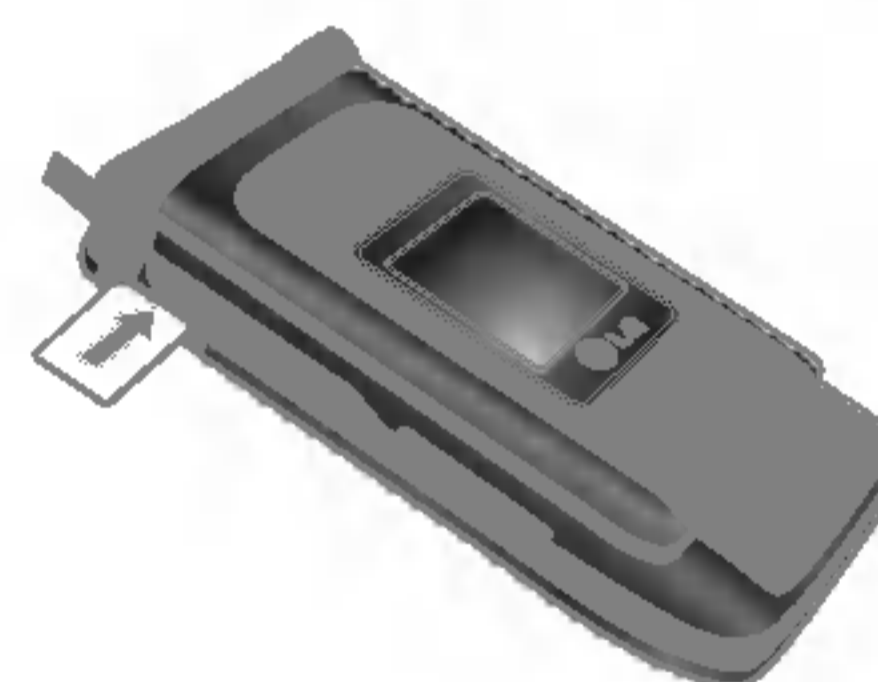

Insert the memory card

Removing the memory card

1. Push in memory card with the tip of your finger into the slot which will activate the eject mechanism.
2. Carefully pull the memory card out of slot.

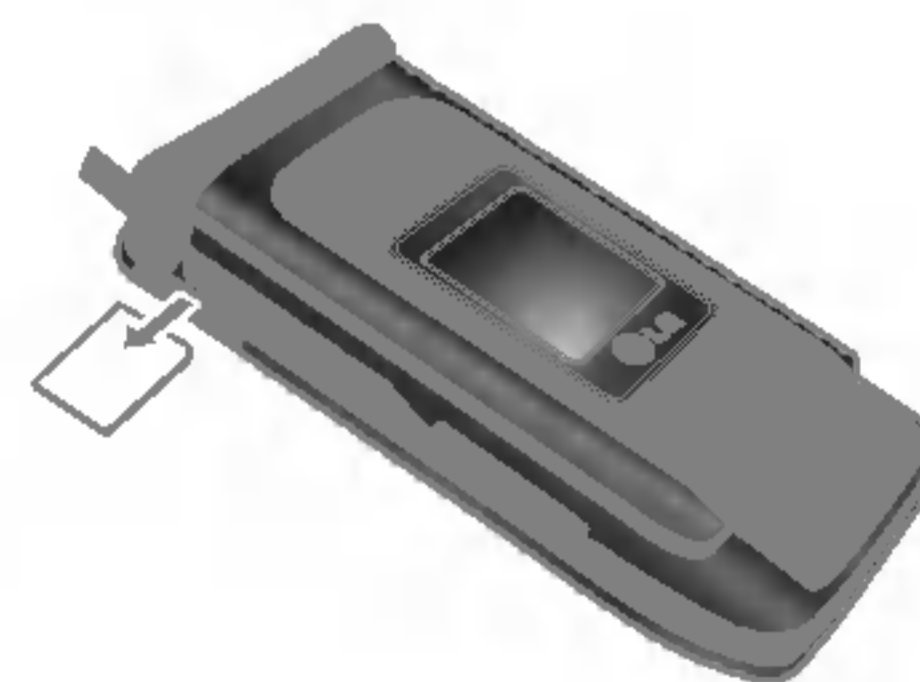

Remove the memory card

Memory card formatting

Before you start using the memory card it is necessary to format it. After you insert the memory card, select Menu-Settings-Reset settings-Clear external memory [Menu 6-9] (see p.55), then press OK. This operation should be done only when you insert memory card for the first time. During formatting various folders will be created for different data types.

! Note

- Please note formatting the memory card will erase all data on the card.

If you do not wish for this to happen, to create the folders on the card you need to do the following;

1. Insert the memory card into the slot.
2. Access the external memory by pressing the following keys. Menu, My stuff (6), External Memory (9).
3. 7 Folders are displayed
 - 1) Videos
 - 2) Photos
 - 3) Music
 - 4) Text
 - 5) Images
 - 6) Sounds
 - 7) Others
4. To create the above folders onto the memory card, you must open each folder individually. A "List empty" message will be displayed as you access each folder, and at the same time this folder will be created on the card.

5. If you now place your memory card into your pc, those 7 folders which you have just created will be displayed as sub folders under My Media.
6. Alternately you can create the folders yourself, if you insert the new memory card into your pc, you can create the main folder "My Media" and within that folder create the 7 sub folders listed.

! **Note** Please note that any extra folders/sub folders you create will not be visible on the phone via External memory.





Memory card adapter

When you insert the memory card into its adapter, it can be used with other memory sticks which are compatible with devices such as PC's to exchange and save data to without a data cable.



1. Insert the memory card into adapter.
2. Insert the adapter into the SD slot of the PC.
3. Check the status of the external memory on the PC.

! **Note** Before connecting this memory card adapter to your PC, check whether your PC has a built in SD slot or not.

Making a Call

1. Make sure your phone is powered on.
2. Enter a phone number including the area code. To edit a number on the display screen, simply press the  key to erase one digit at a time.
 - ▶ Press and hold the  key to erase the entire number.
3. Press the  key to call.
4. When you want to finish, press the  key.

Making a call from the call history list.

1. Press the  key, and the most recent incoming, outgoing and missed phone numbers will be displayed.
2. Select the desired number by using the navigation keys.
3. Press the  key.

Making International Calls

1. Press and hold the  key for the international prefix. The '+' character can be replaced with the international access code.
2. Enter the country code, area code, and the phone number.

3. Press the  key.

Ending a Call

When you have finished a call, press the  key.

Making a Call From the Contact list

You can store names and phone numbers dialed frequently in the SIM card as well as the phone memory known as the Contact list.

You can dial a number by simply looking up a name in the contact list. For more details on the Contacts feature, please refer to page 30.



Adjusting the Volume

During a call, if you want to adjust the earpiece volume, use the side keys of the phone.

In idle mode, you can adjust the key volume using the side keys.

Answering a Call

When you receive a call, the phone rings and the flashing phone icon appears on the screen. If the caller can be identified, the caller's phone number (or name/photo, if stored in your Address Book) is displayed.

1. Open the flip and press the  key or the left soft key to answer an incoming call. If the Any Key menu option (Menu #-3-2), see p. 69, has been set, any key press will answer a call except for the  key or the right soft key.

Note To reject an incoming call, press and hold the side keys on the left side of the phone.

2. End the call by closing the phone or pressing the  key.

Note You can answer a call while using the Address Book or other menu features. In case phone is connected with PC via USB cable, incoming call will be rejected, but after disconnecting phone from PC you can see Missed call window.

Vibrate Mode (Quick)

Vibrate Mode can be activated by pressing and holding the left navigation key.

Signal Strength

If you are inside a building, being near a window may give you better reception. You can see the strength of your signal by the signal indicator () on your phone's display screen.

Entering Text

You can enter alphanumeric characters by using the phone's keypad. For example, storing names in the Address Book, writing a message, creating scheduling events in the calendar all require entering text. The following text input methods are available in the phone.

Note Some fields may allow only one text input mode (e.g. telephone number in address book fields).

T9 Mode

This mode allows you to enter words with only one keystroke per letter. Each key on the keypad has more than one letter. The T9 mode automatically compares your keystrokes with an internal linguistic dictionary to determine the correct word, thus requiring far fewer keystrokes than the traditional ABC mode.

ABC Mode

This mode allows you to enter letters by pressing the key labeled with the required letter once, twice, three or four times until the letter is displayed.

123 Mode (Numbers Mode)

Type numbers using one keystroke per number. To change to 123 mode in a text entry field, press  key until 123 mode is displayed.

Symbolic Mode

This mode allows you to enter special characters.



Changing the Text Input Mode





1. When you are in a field that allows characters to be entered, you will notice the text input mode indicator in the upper right corner of the display.
2. If you want to change modes, press  .
The available modes are changed.



Using the T9 Mode

The T9 predictive text input mode allows you to enter words easily with a minimum number of key presses. As you press each key, the phone begins to display the characters that it thinks you are typing based on a built-in dictionary. As new letters are added, the word changes to reflect the most likely candidate from the dictionary.

Note You can select a different T9 language from the menu option by holding down the  key. The default setting on the phone is T9 enabled.

1. When you are in the T9 predictive text input mode, start entering a word by pressing keys  to . Press one key per letter.
 - ▶ The word changes as letters are typed—ignore what's on the screen until the word is typed completely.
 - ▶ If the word is still incorrect after typing completely, press the down navigation key once or more to cycle through the other word options.

Example: Press     to type **Good**.

 - ▶ If the desired word is missing from the word choices list, add it by using the ABC mode.
2. Enter the whole word before editing or deleting any keystrokes.
 3. Complete each word with a space by pressing the key  or  key.

To delete letters, press  . Press and hold down  to erase the letters continuously.

Note To exit the text input mode without saving your input, press  . The phone returns to the idel screen.

Using the ABC Mode

Use the **2abc** to **9wxyz** keys to enter your text.

1. Press the key labeled with the required letter:
 - ▶ Once for the first letter.
 - ▶ Twice for the second letter.
 - ▶ And so on.
2. To insert a space, press the **☐±** key once. To delete letters, press the **☐=** key. Press and hold down the **☐=** key to erase the letters continuously.

! Note Refer to the table below for more information on the characters available using the keys.

Characters in the Order Display		
1 ☐	. , - ? ! ' @ : 1	. , - ? ! ' @ : 1
2 abc	A B C 2	a b c 2
3 def	D E F 3	d e f 3
4 ghi	G H I 4	g h i 4
5 jkl	J K L 5	j k l 5
6 mno	M N O 6	m n o 6
7 pqrs	P Q R S 7	p q r s 7
8 tuv	T U V 8	t u v 8
9 wxyz	W X Y Z 9	w x y z 9
☐ ±	Space 0	Space 0

Using the 123 (Numbers) Mode

The 123 Mode enables you to enter numbers in a text message (a telephone number, for example).

Press the keys corresponding to the required digits before manually switching back to the appropriate text entry mode.

Using the Symbol Mode

The Symbol Mode enables you to enter various symbols or special characters.

To enter a symbol, press the ***☐** key. Use the navigation keys to select the desired symbol and press the [OK] key.

Your phone offers a set of functions that allow you to customize the phone. These functions are arranged in menus and sub-menus, accessed via the two soft keys marked **[]** and **[]**. Each menu and sub-menu allows you to view and alter the settings of a particular function.

The roles of the soft keys vary according to the current context; the label on the bottom line of the display just above each key indicates its current role.

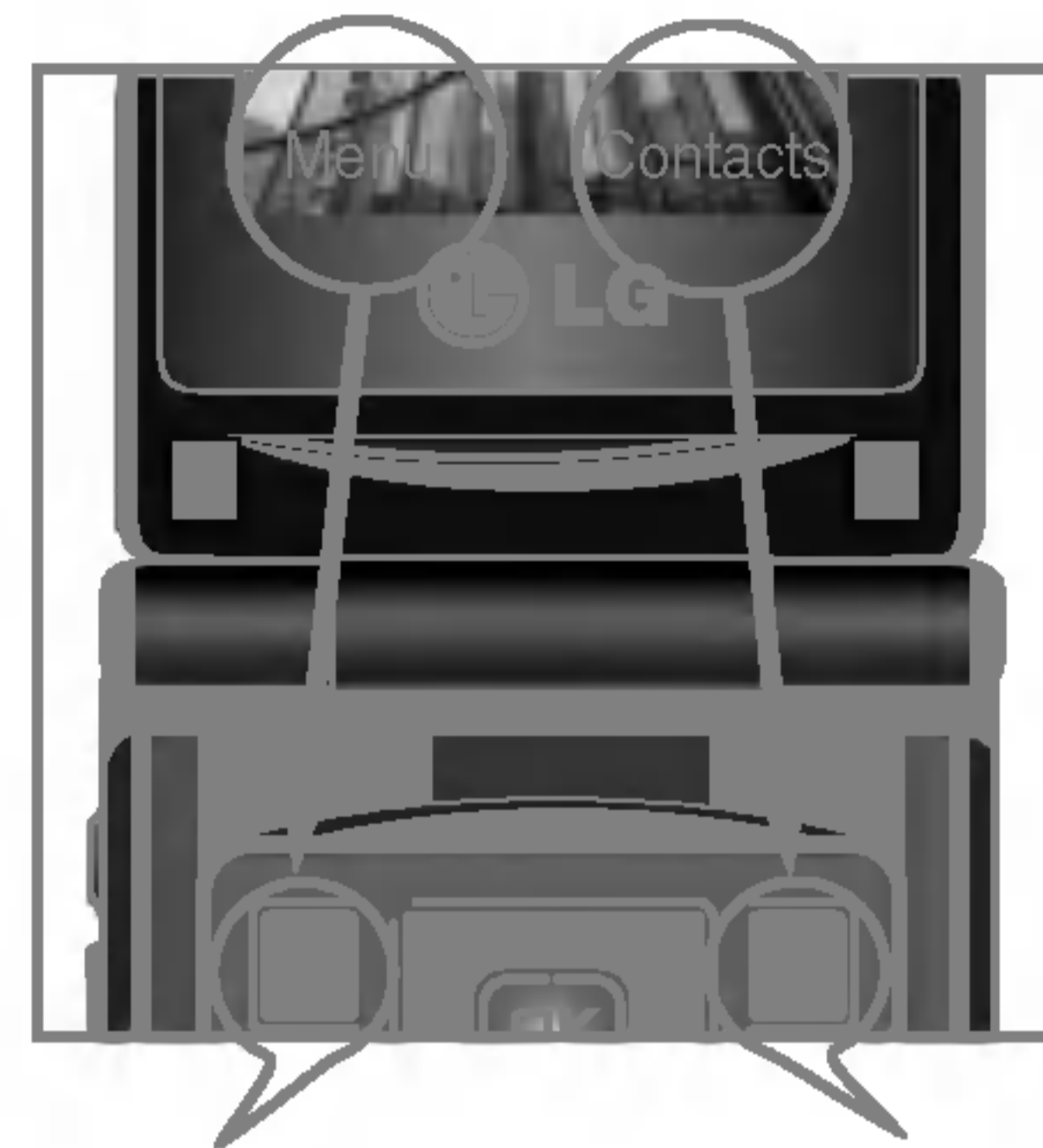

Press the left soft key to access the available Menu.

Press the right soft key to access the available Contacts.

Your phone provides a number of control functions that you can use during a call. To access these functions during a call, press the left soft key  [Options].

During a Call

The menu displayed on the handset screen during a call is different than the default main menu displayed when in idle screen, and the options are described below.

Speaker phone

During call you can activate speaker phone selecting Options/Speaker phone on, or by pressing OK button. To mute speaker phone select Options/Speaker phone off, or press OK button one more time.

Making a Second Call (Network Dependent)

You can get a number you wish to dial from the Address Book to make a second call. Press the Right soft key then select Contacts.

Swapping Between Two Calls

To switch between two calls, press  key or the left soft key, and then select Swap.

Answering an Incoming Call

To answer an incoming call when the handset is ringing, simply press the  key. The handset is also

able to warn you of an incoming call while you are already on a call. A tone sounds in the earpiece, and the display will show that a second call is waiting.

This feature, known as **Call Waiting**, is only available if your network supports it.

For details of how to activate and deactivate it see **Call Waiting** (Menu #-3-4, see p. 69)

If Call Waiting is on, you can put the first call on hold and answer the second, by pressing .

Rejecting an Incoming Call

You can reject an incoming call without answering by simply pressing the  key.

During a call, you can reject an incoming call by pressing the  key.

Muting the Microphone

You can mute the microphone during a call by pressing the [Options] key then selecting [Mute]. The handset can be unmuted by pressing the [Unmute]. When the handset is muted, the caller cannot hear you, but you can still hear them.

DTMF tones while calling

To switch on DTMF tones while calling (e.g. to use the phone with an automatic switchboard) press the key [Options] followed by Send DTMF – DTMF on. Select DTMF off to disable DTMF tones. DTMF tones



In-Call Menu

are normally on.

Conference Calls

The conference service provides you with the ability to have a simultaneous conversation with more than one caller, if your network service provider supports this feature. A conference call can only be set up when you have one active call and one call on hold, both calls having been answered. Once a conference call is set up, calls may be added, disconnected or separated (that is, removed from the conference call but still connected to you) by the person who set up the conference call. These options are all available from the In-Call menu. The maximum callers in a conference call are five. Once started, you are in control of the conference call, and only you can add calls to the conference call.



Making a Second Call

You can make a second call while currently on a call. Enter the second number and press the . When the second call is connected, the first call is automatically placed on hold. You can swap between calls, by pressing the  key.

Setting Up a Conference Call

To set up a conference call, place one call on hold and while the active call is on, press the left soft key and then select the Join menu of Conference call.

Activate the Conference Call on Hold

To activate a conference call on hold, press the  key. Alternatively press the left soft key [Options] and select Conference/Hold all calls. Other users on hold will stay connected. To return to conference call mode, press the left soft key  [Options] followed by Conference call.

Adding Calls to the Conference Call

To add a call to an existing conference call, press the left soft key, and then select the Join menu of Conference call.

Private Call in a Conference Call

To have a private call with one caller from a conference call, display the number of the caller you wish to talk to on the screen, then press the left soft key. Select the Private menu of Conference call to put all the other callers on hold.

Ending a Conference Call

Currently displayed caller from a conference call can be disconnected by pressing the  key.

1 Games & Apps



- 1 Games & Apps
- 2 Profiles

2 Contacts



- 1 Search
- 2 Add new
- 3 Caller groups
- 4 Speed dial
- 5 Own number
- 6 My business card
- 7 Settings

3 Organiser



- 1 Calendar
- 2 Memo

4 Multimedia



- 1 Camera
- 2 Video camera
- 3 Voice recorder
- 4 MP3
- 5 Photo album
- 6 Video album
- 7 Settings

5 Messages



- 1 New message
- 2 Inbox
- 3 Mailbox
- 4 Drafts
- 5 Outbox
- 6 Listen to voice mail
- 7 Info message
- 8 Templates
- 9 Settings

6 My stuff



- 1 Videos
- 2 Photos
- 3 Music
- 4 Text
- 5 Images
- 6 Sounds
- 7 Others
- 8 Games & Apps
- 9 External memory

7 Display



- 1 Wallpaper
- 2 Menu colour
- 3 Standby text
- 4 Backlight
- 5 Network name

8 Profiles



- Vibrate only
- Silent
- General
- Loud
- Headset

9 Tools



- 1 Favourites
- 2 Alarm clock
- 3 Bluetooth
- 4 Modem
- 5 Calculator
- 6 Unit converter
- 7 World time
- 8 SIM-Menu

* Browser



- 1 Home
- 2 Bookmarks
- 3 Go to URL
- 4 Settings

0 Call register



- 1 Missed calls
- 2 Received calls
- 3 Dialed calls
- 4 All calls
- 5 Delete recent calls
- 6 Call charges
- 7 GPRS information

Settings



- 1 Date & Time
- 2 Language
- 3 Call
- 4 Security
- 5 Network
- 6 GPRS Attach
- 7 Memory status
- 8 Reset settings

Games & Apps

[Menu 1-1]

- **Default Games:** In this menu, you can manage the Java applications installed in your phone. You can play or delete downloaded applications, or set the connect option. The downloaded applications are organised in folders.

Press the left soft key  [Select] to open the selected folder or launch the selected midlet.

After selecting a folder, press [Options] and then sub menus available to several options are displayed.

- ▶ **Open:** You can see the stored games.
- ▶ **New folder:** Create a new folder.

Profiles

[Menu 1-2]

A profiles is the network information used to connect to the Internet.

If you want to see the details of a profile, please refer to [Menu *-4-1], see p. 64.

Java™, is a technology developed by Sun Microsystems. Similar to the way you would download the Java Applet using the standard MS Internet Explorer browsers, Java MIDlet can be downloaded using a WAP enabled phone. Depending on the service provider, all Java based programs such as Java games can be downloaded and run on a phone. Once downloaded, the Java program can be viewed in the **My games & more** menu where you can select, execute, or delete. The Java program files saved in the phone are in .JAD or .JAR format.

- ! **Note** • The JAR file is a compressed format of the Java program and the JAD file is a description file that includes all detailed information. From the network, prior to download, you can view all detailed file descriptions from the JAD file.
- While being based on a standard language (J2ME), not all Java applications are compatible with all handsets on sale insofar as specific libraries may be used for a telephone model. The software may be blocked or switch itself on when Java applications not specifically developed for the phone this manual refers to are downloaded, making it necessary to “restart” the handset. We would like to point out that these problems are caused by incompatible applications and are not a product fault.

! **Caution** Only J2ME(Java 2 Micro Edition) based programs will run in a phone environment. The J2SE(Java 2 Standard Edition) based programs will only run in a PC environment.

Contacts [Menu 2]

Search

[Menu 2-1]

1. Select **Search** by pressing the right soft key  [Contacts] or [OK].

2. Enter the name that you want to search.

Note Instant searching is available by inputting the initial letter of the name or number you want to search.

3. If you want to edit, delete or copy an entry, select the left soft key  [Options]. The following menu will be displayed.

- ▶ **Edit:** You can edit the name, number, group, character and picture by using the navigation key.
- ▶ **Write messages:** After you have found the number you want, you can send a text/multimedia message to the selected number.
- ▶ **Send via Bluetooth:** You can send the data of phone book to devices which is compatible with bluetooth through Bluetooth.
- ▶ **Copy to handset:** You can copy an entry from SIM to phone or from phone to SIM.
- ▶ **Assign speed dial:** You can assign the entry as a speed dial.
- ▶ **View caller groups:** For further details see [Menu 2-3].







▶ **Delete:** You can delete an entry.

Add new

[Menu 2-2]

You can add a phonebook entry by using this function. Phone memory capacity is 1000 entries. SIM card memory capacity depends on the cellular service provider. You can also save 20 characters of name in The Phone memory, and save characters in the SIM card. The number of characters is a SIM dependent feature.

Note Maximum stored name and number length depends on SIM-card type.

1. Select **Add new** by pressing the left soft key  [Select] or [OK].
2. Select the memory you want to save: **SIM** or **Phone**. If you set to Phone, you need to select which number you want as a main number.
 - a. Press  [OK] to input a name.
 - b. Press  [Save], then you can input a number.
 - c. You can set a group for the entry by pressing  , .
 - d. You can set a character and a picture for the entry by pressing  , .

Caller groups

[Menu 2-3]

You can add up to 20 members per group, with up to a maximum of 7 groups in total.

- ▶ **Member list:** Shows the group members you have selected.
- ▶ **Group ring tone:** Allows you to specify ring tone for the group members' call.
- ▶ **Group icon:** Allows you to select the icon dependent on Group.
- ▶ **Add member:** You can add group members. Each group should not exceed 20 members.
- ▶ **Remove member:** You can remove the member from the Group member list. But the name and the number will be remained in phonebook.
- ▶ **Rename:** You can change a group name.
- ▶ **Remove all:** Allows you to delete all the members in the group.

Speed dial

[Menu 2-4]

Assign contacts to any of the keys **2abc** to **9wxyz**. You can then call that contact by pressing the corresponding number key.

1. Open the phonebook first by pressing the right soft key **1** [Contacts] in standby mode.
2. Scroll to **Speed dial**, then press the left soft key **2** [Select].
3. If you want to add speed dial, select (**empty**). Then, you can search the name in phonebook.
4. After assigning the number as speed dial, you can change and delete the entry. You can also make a call or send a message by this number.

Own number(Sim dependent) [Menu 2-5]

You can save and check your own number in SIM card.

My business card

[Menu 2-6]

This option allows you to create your own business card featuring Name and an mobile phone number. To create a new business card, press the left soft key **2** [Edit] and enter the information into the fields.

Settings

[Menu 2-7]

1. Press the right soft key **1** [Contacts] in standby mode.
2. Scroll to **Settings**, then press the left soft key **2** [Select].

Contacts [Menu 2]

► **Default memory**

Scroll to highlight **Default memory**, and then press the left soft key  [Select].

- If you select **Always ask**, when adding entry, the phone will ask where to store.
- If you select **SIM** or **Phone**, the phone will store an entry to SIM or phone.



► **View options**

Scroll to highlight **View options**, and then press the left soft key  [Select].

- **Name only**: Set the phonebook list by displaying the name only.
- **Name & number**: Set the phonebook list by displaying the name and number.
- **With pictures**: Set the phonebook list with the information and picture of contact.

► **Copy/Move all**

You can copy/move entries from SIM card memory to Phone memory and vice versa.

1. Open the Phonebook first by pressing the right soft key  [Contacts] in standby mode.
2. Scroll to **Copy/Move all**, and then press the left soft key  [Select] to enter this menu.





- **SIM to Phone**: You can copy/move the entries from SIM Card to Phone memory.

- **Phone to SIM**: You can copy/move the entries from Phone memory to SIM Card.

► **Memory in use**: This feature allows you to see how many entries are in use, or free in your phonebook.

► **Clear contacts**

You can delete all the entries in the SIM and Phone. This function requires the Security code.

1. Scroll to highlight Clear contacts, and then press the left soft key  [Select].
2. Highlight the memory you wish to erase, and then press the left soft key  [Select].
3. Enter the security code and press the left soft key  [OK] or the right soft key  [Back].

► **Service dial number**

Use this function to access a particular list of services provided by your network operator (if supported by the SIM card).











Calendar

[Menu 3-1]

When you enter this menu a calendar will be displayed. The month and year are shown at the top of the screen. Whenever you change the date under the Settings menu, the calendar will update automatically.

The current date will be highlighted in green and any schedule or memos will be indicated with a red triangle at the top left hand corner of the corresponding square. An audible alarm can be set for memo's and reminders.

To change the day, month, and year.

	Description		Description
   def	Yearly	 	Weekly
   	Monthly	 	Daily

In the scheduler mode, press left soft key  [Options] as follows;

Add new



[Menu 3-1-1]



Allows you to add new schedule and memo for the chosen day. You can store up to 20 notes.

Input the subject and then press left soft key  [OK]. You enter the appropriate information in the following section; **Time**, **Repeat** and **Alarm**.

View daily schedules

[Menu 3-1-2]

View all schedules and memo for the chosen day. Use  ,  to browse through the note lists. If you set alarm for the note, the alarm icon is displayed.

If you want to view the note in detail, press the left soft key  [Select]. Press left soft key  [Options] to delete, edit the note you selected.

Delete past

[Menu 3-1-3]

You can delete the past schedule that you have already been notified of.

Delete all

[Menu 3-1-4]

You can delete all the notes.

Go to date

[Menu 3-1-5]

You can go the chosen date directly.





Set alarm tone

[Menu 3-1-6]

You can set the alarm tone of each chosen date.

Memo

[Menu 3-2]

1. Select the **Memo** by pressing the left soft key
 [Select].
 2. If the entry is empty, press the left soft key
 [Write].
 3. Input the memo and then press the left soft key
 [OK].
- !** **Note** If you want to change the text input mode, press the  in order.







You can enjoy your multimedia functions such as camera, voice recorder, MP3 for your fun and convenience.







- ! Note**
- When a low battery indication is given, the Camera or Multimedia function may not operate.
 - The battery level indication may appear lower when using the Multimedia functions, due to high current consumption.







Camera









[Menu 4-1]

• To take a picture with phone opened

1. Press the Menu key  and then navigate and select Multimedia. Select Camera and the screen will now become the viewfinder. If you want to reach this menu directly, press  or  for a few seconds.
2. Focus on the subject to capture the image, and then press the  key.
3. If you want to save it, press the left soft key  or the  key.

- ! Note** You can control the image size, brightness, colour and zooming by going into the camera settings . Then use the , ,  to navigate and change the various settings. ( or ).

- ▶ **Mode** []: Allows to take multishot photos successively.
 - **Still shot:** 72x72, 176x220, 320x240, 640x480, 1280x720, 1280x960, 1600x1200
 - **multishot:** 320x240
 - **frameshot:** 176x220
- ▶ **Scene** []: Allows you to take a picture by using this menu at night.
- ▶ **Effect** []: 4 settings are available: Colour, Sephia, Black & white, Negative.
- ▶ **Flash** []: Allows you to set the flash when you take a photo in dark surroundings.
- ▶ **Zoom** []: Allowing you to set the zooming value from x1, x2, x3 and x4 depending on the resolution.
- ▶ **Brightness** []: Use the right/left navigation keys to adjust lighting. 5 lighting levels are available: -2, -1, 0, 1, 2.
- ▶ **Size** []: Allows you to set the image size to one of Hi (1600x1200), (1280x960), (1280x720), Med (640x480), Low (320x240), (176x220), (72x72) main screen, contact, and front screen. If you want to take panorama(1280x720), you should swivel the phone. Frame shots are only available with the 176x220 pixel resolution.

- ▶ **Timer** []: Allows you to select the time delay (Off, 3 Seconds, 5 Seconds or 10 seconds). Then the phone takes a photo after the specified time.
 - ▶ **Quality** []: Allows you to set the image quality from Normal, Fine and Superfine.
 - ▶ **White Balance** []: Allows you to change the settings according to the environment.
 - ▶ **Auto focus** []: Automatically adjusts the focus for a clear, sharp picture with a single press of a button.
 - ▶ **Metering** []: Determines the lighting based on a certain part of the subject. You can select one of the following options **Centred**, **Spot** and **Combined**.
 - ▶ **Memory in use** []: You can select a storage space; Phone or Memory card.
 - ▶ **Album** []: Allow you to see photos saved in your phone.
- ❗ **Note** In My album you may only view pictures taken by the handset's camera.
- ▶ **Exit** []: Back to the screen mode to take photos.

Once all the desired settings have been selected, focus on the subject to capture and press the Camera key or OK key. With a click, the image is captured and the following menu bar appears.



When you are in Photo Camera capture mode, you may adjust the zoom by pressing the side Up/Down navigation keys.

❗ **Note** To take a panorama photo (1280x720 resolution) you should swivel and close the flip.

• **To take a picture with phone closed**

1. Press and hold [] for a few seconds.
2. A list will be displayed on the sub LCD.

- **MP3**: Activates the MP3 mode.
- **Take picture**: Activates the Take photo mode.
- **Slide show**: View the pictures in Album as a slide show.

Digital Camera Mode

To enter the Digital Camera Mode you should swivel and close the flip whilst the handset is in idle mode. Now the handset will automatically enter Digital Camera Mode.

- To enter the camera's main menu, press and hold the side camera button.
- With side up/down buttons you may scroll through the settings items. After the necessary item is selected, press the side camera button, and you will access the detailed settings of this selected feature. By using the side up/down buttons select the desired setting and press the side camera button for confirmation.
- To exit to camera capture mode you should press the and hold side camera button.
- A short press of the camera key is all that is required to take a photo.

! Note When you are in Digital Camera Mode, and there's no action for some time, the phone will automatically exit to idle mode.



- **Torch:** Activates the flash light.
- **Back:** Goes back to the previous menu.



Video camera [Menu 4-2]

1. Select **Video camera** menu.
2. To be able to record, you must reverse the display of the phone and close.
3. You can also amend the brightness, size, quality and other settings by pressing and holding down the  for a few seconds.

Video camera settings menu is the same with Photo camera settings, except following items:

- ▶ **Size:** You may select following resolution: 128x96, 176x144 and 208x160.
- ▶ **Record time:** You may select recording time from the list: 1 min, 5 min, 30 min, 90 min and unlimited.

Once the settings are displayed on the screen, you can scroll through them using the side keys. Scroll to the setting you wish to change, press the  and it will bring up the setting values. Use the side keys to scroll to your preferred choice and then press the  to select.

4. To start recording press . As soon as it starts to record a timer will be displayed.
5. Press the  to end the recording and this will now be saved.

Voice recorder [Menu 4-3]

With the voice memo feature you can record up to 20 voice messages and each memo can be up to 20 seconds long.

Record [Menu 4-3-1]

You can record a voice memo in the Voice recorder menu.

Multimedia [Menu 4]

1. Once recording has started, the message Recording and the remaining time is displayed.
2. If you want to finish recording, press the left soft key **[Save]**.
3. Key in Voice memo title, press the left soft key **[OK]**.

View list [Menu 4-3-2]

The list of voice memos are displayed. You can playback and delete the recorded voice memo. The following [Options] menus are available

- ▶ **Play:** Allows you to listen to the recorded voice memo.
- ▶ **Send:** Allows you to send via multimedia message and e-mail.
- ▶ **Delete:** Allows you to delete voice memo.
- ▶ **Delete all:** Allows you to delete all voice memos.

MP3 [Menu 4-4]

The P7200 has an integrated MP3 player. You can enjoy listening to MP3 music files on your phone memory using a compatible headset or via the internal loudspeaker.

- ! **Note** Because of the small dimension of the speaker, in some cases the audio could be distorted, espe-

cially at maximum volume and when there are lots of bass sounds. Therefore, we recommend you to use the stereo headset in order to appreciate the high quality of your music.

The music player supports:

- **MPEG-1 Layer III, MPEG-2 Layer III, MPEG-2.5 Layer III:** Sampling frequency up from 8KHz to 48KHz. Bit rate up to 320Kbps, stereo.
- **AAC:** ADIF, ADTS formats (Sampling frequency from 8KHz to 48KHz)
- **AAC+:** V1 : (Bit rate 16~128Kbps)
V2 : (Bit rate 16~48Kbps)
(Sampling frequency from 8KHz to 48KHz)
- **MP4, M4A:** Sampling frequency up from 8KHz to 48KHz, Bit rate up to 320Kbps, stereo.
- **WMA:** Sampling frequency up from 8KHz to 48KHz, Bit rate up to 320Kbps, stereo.

- ! **Note** P7200 doesn't support the variable bit rate of all mentioned file types. Therefore, you can't change the file from MP3 format to AAC.

You can transfer MP3 files from a compatible PC to the memory in your phone using the Mass Storage.

When you connect the phone to a PC using the USB cable (supplied in the same package), and then you can show removable disk through windows explorer.

After you copy songs in removable disk, you should execute safe remove from your system.

- ! Note**
- You should copy your MP3 files to My media\Music folder. If you copy to another folder, you will not be able to view MP3 files.
 - The PC should run Windows 98 SE, Windows ME, Windows 2000, Windows XP operating system.

MP3 player

[Menu 4-4-1]

The following screen is shown up.

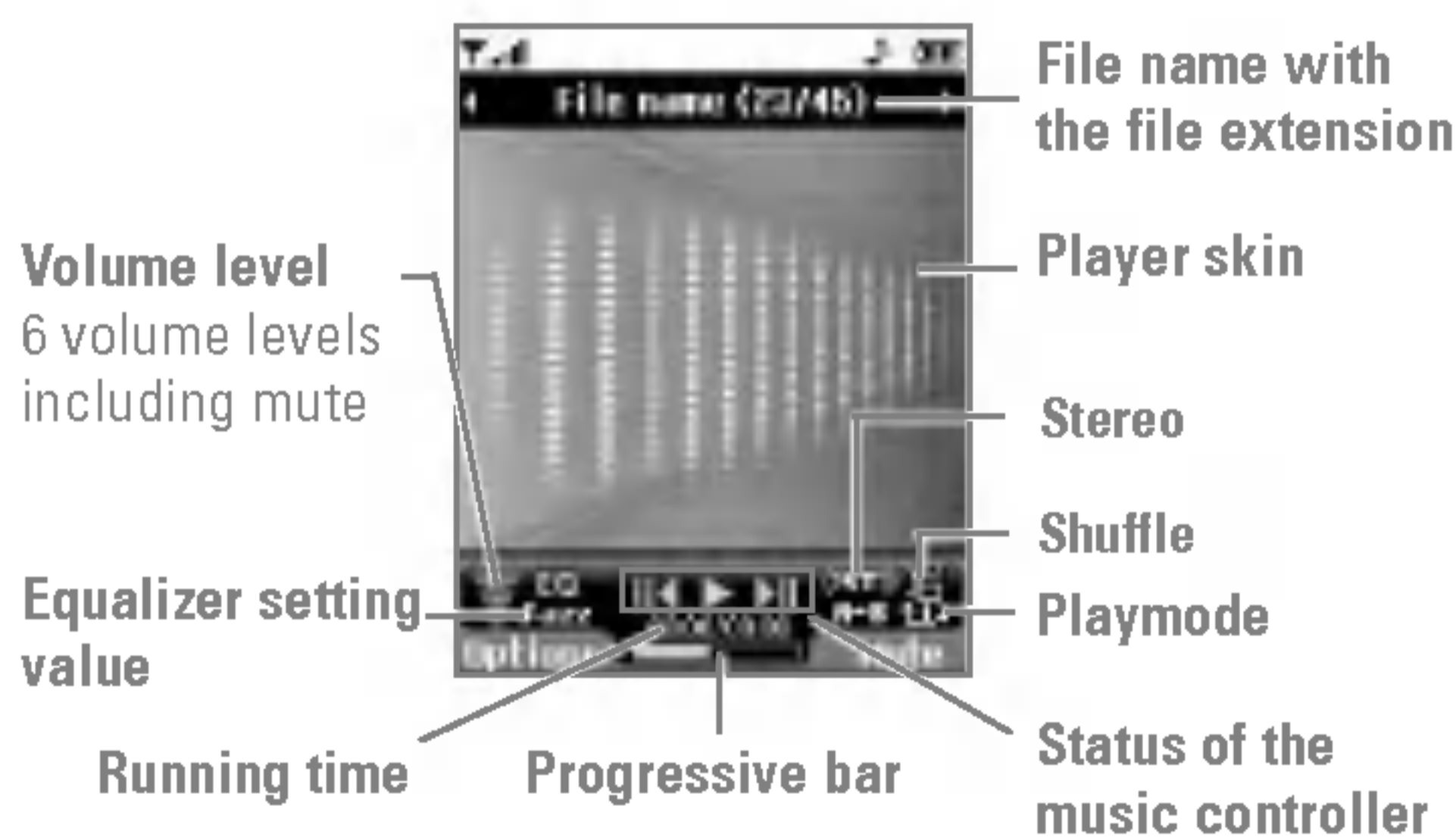

Repeat	Loop
<ul style="list-style-type: none"> ■ Play all ■ Repeat all ■ Repeat one 	<ul style="list-style-type: none"> ■ A → B

! Note In case that any invalid file is included in the playlist, an error message will be popped up and go back to the prior screen.

1. Press MP3 menu, and then select MP3 player.
2. Press the left soft key **[Options]** to access the following menus.
 - ▶ **View playlist:** You can select another MP3 file you wish to play.
 - ▶ **Area repeat:** The special area part of the current music is repeated when you select ON of the menu.
 - ▶ **Set as ringtone:** You can set an MP3 file as a ringtone.
 - ▶ **Settings:** There are 5 settings under this menu, which are explained in more detail on the next page.

Playlist

[Menu 4-4-2]

This menu allows you to view the whole play list. You can move through the tracks by pressing the navigation key. In addition, once you have selected the track, you can delete the file or view its information via the options menu.

Settings

[Menu 4-4-3]

▶ Equalizer

This phone has 5 preset equalizer settings. When you enter this menu, you can view and change the settings as desired.

▶ Playmode

This menu allows you to set the play mode: Play all, Repeat all, Repeat one.

▶ Set shuffle

If you select the ON option, then your saved tracks will be played in a random order.

▶ Visual effect

This menu allows you to change the visual background of the main and sub LCD on the phone whilst an MP3 is playing.

▶ Flip setting:

• Continue playing

Although you close the flip of the phone, your MP3 continues playing without interruption.

• Stop playing

The MP3 will stop playing, once the flip is closed.

! Note Music is copyright protected in international treaties and national copyright laws. It may be necessary to obtain permission or a license to

reproduce or copy music. In some countries national law prohibits private copying of copyrighted material. Please check the national legislation of the applicable country concerning the use of such material.

Photo album

[Menu 4-5]

You can view and send a picture. In addition, you can set the picture as a wallpaper.

▶ **Multi view:** You can view the maximum of 9 thumbnails in a screen.

▶ **Send via Bluetooth:** You can send a picture by Bluetooth.

▶ **Set as wallpaper:** You can set a picture as a wallpaper.

▶ **Slide show:** You can view the pictures in a slide show.

▶ **Delete:** You can delete a picture.

▶ **Edit title:** You can edit the title of picture.

▶ **Information:** Displays information about the saved picture.

! Note The Photo Album will only display pictures taken by the handsets camera.

Video album

[Menu 4-6]

You can view videos which have been saved in the memory.

- ▶ **Play:** You can play the video file when pressing the OK key or selecting Play menu of the Options menu. To play recorded video with 208x160 resolution you should swivel and close flip.
- ▶ **Send via Bluetooth:** Send the selected file to another device via Bluetooth
- ▶ **Copy/Move to external memory:** Copy/Move the selected file to the same folder at Multimedia
- ▶ **Rename:** Change the file name of selected file. The maximum length of characters is 90. In filename it's impossible to use symbols such as / < > # @ * and etc. And You can't change the extension of file.
- ▶ **Delete:** Delete a file.
- ▶ **Delete all:** Delete all files in the list
- ▶ **Information:** Show the file information.

Settings

[Menu 4-7]

Camera

[Menu 4-7-1]

- ▶ **Auto save:** If you set this feature to **On**, the images will be saved automatically without displaying the menu bar to save.
- ▶ **Delete all photos:** You can delete all the photos which have been saved in the memory.

Video camera

[Menu 4-7-2]

- ▶ **Delete all videos:** Allows you to delete all the videos which have been saved in the memory.

Messages [Menu 5]

New message

[Menu 5-1]

This menu includes functions related to SMS (Short Message Service), MMS (Multimedia Message Service), Email, voice mail, as well as the network's service messages.

Write text message

[Menu 5-1-1]

You can write and edit text message, checking the number of message pages.



1. Enter the **New messages** menu by pressing the left soft key  [Select].
2. If you want to write a new message, select **Write text message**.
3. To make text input easier, use T9.
4. Press [Insert] to attach the following;

Insert

- ▶ **Images:** You can insert the Default graphics or graphics in My pictures that are available for short messages.
- ▶ **Sounds:** You can insert sounds that are available for short messages.
- ▶ **Text templates:** You can use Text templates already set in the phone.

- ▶ **Contacts:** You can add phone numbers or e-mail addresses in the address book.
 - ▶ **Symbol:** You can add special characters.
 - ▶ **My business card:** You can add your Business card to the message.
5. After you complete the message, to select the required option, press the left soft key  [Options].

Options

- ▶ **Send:** Sends text messages.
 1. Enter numbers of recipient.
 2. Press  key to add more recipients.
 3. You can add phone numbers in the address book.
 4. Once the numbers have been entered, press the left soft key  to send the message.
All messages will automatically be saved in the outbox folder, even after a sending failure.
- ▶ **Save to drafts:** Stores messages in the Drafts folder.
- ▶ **Font & Alignment:** You can select the **Size** and **Style** of font, and the alignment of text.
- ▶ **Colour:** You can also set the **Colour** of the text (foreground) and the background.

- ▶ **Add T9 dictionary:** You can add your own words. This menu will only be shown when the edit mode has been set to T9ABC/T9Abc/T9abc.
- ▶ **T9 languages:** Select the desired language for T9 input mode. You can also deactivate the T9 input mode by selecting 'T9 off'.
- ▶ **Exit:** If you press Exit whilst writing a message, you will be taken back to the message menu. Also the written message will not have been saved.

! Note This phone supports EMS release 5, so is available to send colour pictures, sounds, text styles, etc.. If the other parties handsets do not support such options, the pictures, sounds or texts sent may not be displayed correctly on their phones.

Write multimedia message [Menu 5-1-2]

A multimedia message can contain text, images, and/or sound clips. This feature can be used only if it is supported by your network operator or service provider. Only devices that offer compatible multimedia message or e-mail features can receive and send multimedia messages.

1. Enter the **New message** menu by pressing the left soft key  [Select].

2. If you want to write a new message, select **Write multimedia message**.
3. You can create a new message or choose one of the multimedia message templates already made.
4. Press **Insert** to add Image, Sound, External memory, Contacts, Symbol, New photo, New sound, Text templates, My bussiness card.

Maximum available file size, that can be inserted to MMS-message, is 100 kb.

Options

- ▶ **Send:** You can send multimedia messages to multiple recipients, as well as save it to send at a later time.

! Note All messages will be automatically saved in the outbox folder, even after a sending failure.

- ▶ **Preview:** You can preview multimedia messages you have created.
- ▶ **Save:** You can save multimedia messages **To drafts** or **As template**.
- ▶ **Edit subject:** Allows you to modify the multimedia message you have chosen.
- ▶ **Add slide:** You can add a slide before or after current slide.

Messages [Menu 5]

- ▶ **Move to slide:** You can move to previous or next slide.
- ▶ **Delete slide:** You can delete current slides.
- ▶ **Set slide format**
 - **Set timer:** You can set a timer for slide, text, picture and sound.
- ▶ **Add T9 dictionary:** You can add your own words. This menu will only be shown when the edit mode has been set to T9ABC/T9Abc/T9abc.
- ▶ **T9 languages:** Select the desired language for T9 input mode. You can also deactivate T9 input mode by selecting 'T9 off'.
- ▶ **Exit:** Will take you back to the Message menu.

❗ **Note** When creating a multimedia message, if you upload a picture (50K) you may find that whilst the picture is loading you will not be able to carry out any other actions until the picture has completed loading.

Write email message [Menu 5-1-3]

To send/receive an email, you should set up the email account. Refer to **Email** on page 49 first.

1. You can input up to 12 email addresses in the To and Cc field.

Tip: To input "@", press the ***..** and select "@".

2. Key in the subject of the mail and press OK.
3. After writing an email message, press the left soft key **[Options]**. You can access the following option menus.
 - ▶ **Send:** Sends the email message.
 - ▶ **Edit recipients:** You can edit recipients.
 - ▶ **Edit subject:** You can edit the subject.
 - ▶ **Save to drafts:** Select this to save the message in **Drafts**.
 - ▶ **T9 dictionary:** Select the language for T9 input mode. You can also deactivate the T9 input mode by selecting 'T9 off'.
 - ▶ **Exit:** If you select Exit whilst writing a message, you will be taken back to the message menu. Also the written message will not have been saved.
4. You can attach files by pressing the right soft key **[Attach]**.

❗ **Note** • For each e-mail account you may save up to 50 messages (totally 150 for three accounts). In Inbox folder you may save not more than 30 messages, in Drafts and Outbox folders - 5 messages, and in Sent folder up to 10 messages. In case Drafts Outbox or Sent folder is full, and you try to save new message to one of this folders, first saved message will be automatically deleted.







- Maximum size for one sent message is 300 kb with attachments, and maximum size for one received message is 100 kb. In case you have received message with more than 5 attachments, only 5 of them will be received. Some attachment may display incorrectly.

Inbox

[Menu 5-2]

You will be alerted when you have received a message. They will be stored in the Inbox.

In the Inbox, you can identify each message by icons. For detail, see the icon directive.

	Icon directive
	Multimedia message
	Short message
	SIM message
	Read multimedia message
	Read text message
	Push message
	Notified multimedia message

If the phone shows 'No space for SIM message', you only have to delete the SIM messages from the Inbox. If the phone displays 'No space for message', you will then need to delete messages, media or

applications to free up space.

* SIM message

SIM message means that the message is exceptionally stored in the SIM card. You can move this message to the phone.

When you are notified that you have received a multimedia message, you have to wait for the message to be downloaded before you can view it.

To read a message, select one of the messages by pressing the left soft key .

- ▶ **View:** You can view the received messages.
- ▶ **Delete:** You can delete the current message.
- ▶ **Reply:** You can reply to the sender.
- ▶ **Forward:** You can forward the selected message to another party.
- ▶ **Return call:** You can call back the sender.
- ▶ **Information:** You can view information about received messages; Sender's address, Subject (only for Multimedia message), Message date & time, Message type, Message size.
- ▶ **Delete all:** You can delete all messages.

Mailbox

[Menu 5-3]

When you access this menu, you can either connect to your remote mailbox to retrieve your new email messages, or you can view the previously retrieved email messages without logging in to the email server.

You can check the saved emails, drafts, outbox, and sent emails. In the Inbox, up to 30 emails are stored.

Drafts

[Menu 5-4]

Using this menu, you can preset up to five multimedia messages that you use most frequently. This menu shows the preset multimedia message list.





The following options are available.

- ▶ **View:** You can see the multimedia messages.
- ▶ **Edit:** Allows you to modify the chosen message.
- ▶ **Delete:** Deletes the message you choose.
- ▶ **Information:** To view the information of the message.
- ▶ **Delete all:** Deletes all of the messages in the folder.

Outbox



[Menu 5-5]

This menu allows you to view the messages which you have sent, those that are currently sending or messages that have failed sending previously.

	Icon directive
	MMS Unsent
	MMS delivery confirmed
	SMS unsent
	SMS delivery confirmed

- ▶ **View:** You can view the message.
- ▶ **Forward:** You can forward the selected message to another party.
- ▶ **Delete:** You can delete the message.
- ▶ **Information:** You can check the information of each message.
- ▶ **Delete all:** You can delete all the messages in the outbox.

Listen to voice mail [Menu 5-6]



Once this menu has been selected, simply press the left soft key  [OK] to listen to voice mail. You can also hold down the  key in standby mode to listen to voice mail.

Note When you receive a voice mail, your phone will display an icon and you will hear an alert. Please check with your network provider for details of their service in order to configure the handset correctly.

Info message [Menu 5-7] (Dependent to network and subscription)

Info service messages are text messages delivered by the network to your handset. They provide general information such as weather reports, traffic news, taxis, pharmacies, and stock prices. When you receive an info service message, you will see a popup message show you that or the info service message is directly displayed. To view the message again follow the sequence shown below;

Read [Menu 5-7-1]

1. When you have received an info service message and select Read to view the message, it will be displayed on the screen. You can read another message by scrolling ,  or  [Next].
2. The message will be shown until another message is selected.

Topics [Menu 5-7-2] (Dependent to network and subscription)

- ▶ **Add new:** You can add Info service message numbers in the Phone memory with its nickname.
- ▶ **View list:** You can see Info service message numbers which you have added. If you press  [Options], you can edit and delete info message categories which you have added.
- ▶ **Active list:** You can select info service message numbers in the active list. If you activate an info service number, you can receive messages sent from the number.

Messages [Menu 5]

Templates

[Menu 5-8]

Text templates

[Menu 5-8-1]

You have 6 text templates as below;

- **Please call me back.**
- **I'm late. I will be there at**
- **Where are you now?**
- **I am on the way.**
- **Top urgent. Please contact.**
- **I love you.**

Multimedia templates

[Menu 5-8-2]

After you have saved a new template, you can use the following options.

- ▶ **View:** You can see multimedia templates.
- ▶ **Delete:** You can delete multimedia templates.
- ▶ **Add new:** Allows you to add new multimedia templates.
- ▶ **Write messages:** You can write and send multimedia messages.
- ▶ **Edit:** You can edit multimedia templates.
- ▶ **Delete all:** Allows you to delete all multimedia messages.

Settings

[Menu 5-9]

Text message

[Menu 5-9-1]

▶ **Message types:**

Text, Voice, Fax, Natl. paging, X.400, E-mail, ERMES

Usually, the type of message is set to **Text**. You can convert your text into alternative formats. Contact your service provider for the availability of this function.

- ▶ **Validity period:** This network service allows you to set how long your text messages will be stored at the message centre.

- ▶ **Delivery report:** If you set to **Yes**, you can check whether your message is sent successfully.

- ▶ **Reply charging:** When a message is sent, it allows the recipients to reply and charge the cost of the reply to your telephone bill.

- ▶ **SMS centre:** If you want to send the text message, you can receive the address of SMS centre through this menu.

Multimedia message

[Menu 5-9-2]

- ▶ **Priority:** You can set the priority of the message you choose.

- ▶ **Validity period:** This network service allows you to set how long your text messages will be stored at the message centre.
- ▶ **Subject:** You can enter multimedia messages subject when this menu is on.
- ▶ **Delivery report:** If it is set to **Yes** in this menu, you can check whether your message is sent successfully.
- ▶ **Auto retrieve:** If you select **On**, you receive multimedia messages automatically. If you select **Off**, you receive only notification message in the inbox and then you can check this notification. If you select **Home network only**, you receive multimedia messages depends on Homenetwork.
- ▶ **Network settings:** If you select multimedia message server, you can set URL for multimedia message server.
- ▶ **Permitted message types**
 - Personal:** Personal message.
 - Advertisements:** Commercial message.
 - Information:** Necessary information.

Email

[Menu 5-9-3]

This menu allows you to edit, delete or add an email account.

▶ Account

You can set up to 3 email accounts by selecting Add new.

Using the **Edit** menu, you can set the following values.

▶ Set as default

▶ Edit

- **Title:** Account name.
- **User ID:** Enter your email ID.
- **Password:** Enter your email password.
- **Email address:** Enter the email address given to you by your service provider.
- **Outgoing server:** Enter the SMTP address and Port number fo computer that sends your email.
- **Incoming server:** Enter the POP3 address and Port number of the that receives your email.
- **Leave msg on server:** Select Yes to leave the messages on the server.
- **Insert signature:** Select **Yes** to attach your signature to your email messages.

Messages [Menu 5]

- **Access point:** Allow you to select the access point from the list.
- **SMTP port number:** Allow you to edit SMTP port number.
- **POP3 port number:** Allow you to edit POP3 port number.
- **Outgoing server ID/PW:** Enter the ID and password for sending your email.

▶ **Delete:** Deletes the selected account from the list.

▶ **Access point**

You can edit the access points.

There are default access points for some operators, stored in phone memory.

- ▶ **Title:** Access point name.
- ▶ **APN:** Input the APN of Access point.
- ▶ **User ID:** Enter the User ID of your access point.
- ▶ **Password:** Enter the Password of your access point.

▶ **Signature**

You can make your signature.

Voice mailbox number [Menu 5-9-4]

You can receive the voicemail if your network service provider supports this feature. When a new voicemail has arrived, the symbol will be displayed on the screen. Please check with your network service provider for details of their service in order to configure the phone accordingly.

- ▶ **Home:** You can listen to voice mails by selecting Home.
- ▶ **Roaming:** Even when you are abroad, you can listen to voice mails if a roaming service is supported.

Info message [Menu 5-9-5]

▶ **Receive**

Yes: If you select this menu, your phone will receive Info service messages.

No: If you select this menu, your phone will not receive Info service messages any more.

▶ **Alert**

Yes: Your phone will beep when you have received Info service message numbers.

No: Your phone will not beep even though you have received info service messages.

► Languages

You can select the language you want by pressing [On/Off]. Then, the info service message will be shown in the language that you selected.

Push message

[Menu 5-9-6]

You can set the option whether you will receive the message or not.

My stuff [Menu 6]

! Note Do not change the default folder name, or it does not work properly.

Videos [Menu 6-1]

Show the list of 3GP, 3G2 files at My media\Videos in Multimedia memory.

▶ **Play:** You can play the video file by pressing the OK key or selecting Play from the Option menu. To play recorded videos with 208x160 resolution you should swivel and close flip.

▶ **Send via Bluetooth:** Send the selected file to another device via Bluetooth

! Note You may send files via Bluetooth only if they are stored in the phone memory, not on the memory card. To send files from the external memory, please, firstly copy it to internal phone memory.

▶ **Copy to External memory:** Copy the selected file to the same folder at Multimedia memory/External memory.

▶ **Move to External memory:** Move the selected file to the same folder at Multimedia memory/External memory.

! Warning Please do not remove the external memory whilst in the process of copying/moving a file as this may cause damage to the phone.

▶ **Rename:** change the file name of the selected file. The maximum length of characters is 200. And You

can not change the extension of file.

! Warning The following characters, \ / : * ? " < > can not be used.

▶ **Delete:** Delete a file.

▶ **Delete all:** Deletes all the files in the list

▶ **Information:** Shows the file information.

Photos [Menu 6-2]

Shows the list of JPG files at My media\Photos in Multimedia memory.

▶ **View:** You can see the JPG file by pressing the OK key or selecting View from the Option menu.

! Note The maximum size of JPG file you can see is 460Kbytes.

▶ **Send via email:** Send the selected file to another device via email if the file size is less than 300Kbytes.

▶ **Send via Bluetooth:** Send the selected file to another device via Bluetooth.

! Note

- You may send files via Bluetooth only if they are stored in phone memory, not on memory card. To send files from the external memory, please, firstly copy it to internal phone memory.
- In Photos folder in internal and in external memory only .JPG (.JPEG) files can be stored. In Images folder in internal and in external memory you may store .GIF, .JPG (.JPEG) and other image format files.

- To setup .JPG (.JPEG) file from Photo folder as wallpaper, go to Menu-Multimedia-Photo album and then please select Set as wallpaper in Options menu.

- ▶ **Copy to External memory:** Copy the selected file to the same folder at Multimedia memory/External memory.
- ▶ **Move to External memory:** Move the selected file to the same folder at Multimedia memory/External memory.
- ▶ **Rename:** change the file name of selected file. The maximum length of characters is 200. And You can not change the extension of file.
- ▶ **Delete:** Delete a file.
- ▶ **Delete all:** Deletes all the files in the list
- ▶ **Information:** Shows the file information.

Music [Menu 6-3]

Shows the list of MP3, MP4, AAC, M4A, WMA files at My media\Music in Multimedia memory.

- ▶ **Play:** You can play the MP3 file by pressing the OK key or selecting Play from the Option menu.
- ▶ **Send via Bluetooth:** Send the selected file to another device via Bluetooth

! Note You may send files via Bluetooth only if they are stored in the phone memory, not on memory card. To send file from external memory, please, firstly

copy it to internal phone memory.

- ▶ **Copy to External memory:** Copy the selected file to the same folder at Multimedia memory/External memory.
- ▶ **Move to External memory:** Move the selected file to the same folder at Multimedia memory/External memory.
- ▶ **Rename:** change the file name of selected file. The maximum length of characters is 200. And You can not change the extension of file.
- ▶ **Delete:** Delete a file.
- ▶ **Delete all:** Deletes all files in the list
- ▶ **Information:** Shows the file information.

Text [Menu 6-4]

Show the list of TXT files at My media\Text in Multimedia memory.

- ▶ **View:** You can see the TXT file by pressings the OK key or selecting View from the Option menu.

! Note The maximum size of TXT file you can see is 460Kbytes.

My stuff [Menu 6]

- ▶ **Send via email:** Send the selected file to another device via email if the file size is less than 300Kbytes
- ▶ **Send via Bluetooth:** Send the selected file to another device via Bluetooth.
- ! **Note** You may send files via Bluetooth only if they are stored in the phone memory, not on memory card. To send file from external memory, please, firstly copy it to internal phone memory.
- ▶ **Copy to External memory:** Copy the selected file to the same folder at Multimedia memory/External memory.
- ▶ **Move to External memory:** Move the selected file to the same folder at Multimedia memory/External memory.
- ▶ **Rename:** change the file name of selected file. The maximum length of characters is 200. And You can not change the extension of file.
- ▶ **Delete:** Delete a file.
- ▶ **Delete all:** Delete all files in the list
- ▶ **Information:** Show the file information.

Images

[Menu 6-5]

After selecting a image, press the left key  [View] and then you can check the options as follow:

- ▶ **Set as wallpaper:** Currently selected image can be set as a wallpaper.
- ▶ **Write messages:** The images downloaded from the network can be sent by Multimedia or Email service. Maximum message size is 100 kb for MMS message and 300 kb for E-mail message.
- ▶ **Send via Bluetooth:** The sound downloaded from network can be sent by Bluetooth.
- ! **Note**
 - You may send files via Bluetooth only if they are stored in the phone memory, not on memory card. To send file from external memory, please, firstly copy it to internal phone memory.
 - Maximum .GIF supporting size is 100 Kb.
- ▶ **Copy to External memory:** Copy the selected file to the same folder at Multimedia memory/External memory.

Sounds

[Menu 6-6]

After selecting a sound, press the left key [Options]. You can check the options as follow:

- ▶ **Set as ringtone:** Currently selected sound can be set as a ringtone.
- ▶ **Write messages:** The sound downloaded from network can be sent by SMS or MMS, Email service. Maximum MMS message is 100 kb, and for e-mail is 300 kb.

► **Send via Bluetooth:** The sound downloaded from network can be sent by Bluetooth.

❗ **Note** You may send files via Bluetooth only if they are stored in the phone memory, not on memory card. To send file from external memory, please, firstly copy it to internal phone memory. When you send .MMF or .MIDI sound file from another phone via Bluetooth, it will be saved to Others folder. But if you will setup this file as ring tone, it will be copied to Sounds folder.

► **Copy to External memory:** Copy the selected file to the same folder at Multimedia memory/External memory.

Others **[Menu 6-7]**

Shows the list of files at My media\Others in Multimedia memory.

► **Play:** You can play a file if it is one of the following types; 3G2, MP3, MP4, AAC, M4A and WMA.

► **View:** You can see a file if it is one of the following types; JPG, GIF, WBMP, PNG and TXT.

► **Send via Bluetooth:** Send the selected file to another device via Bluetooth

❗ **Note**

- You may send files via Bluetooth only if they are stored in the phone memory, not on memory card. To send file from external memory, please, firstly copy it to internal phone memory.

- When you connect the phone with PC via Bluetooth, to Music, Video, Others and Text folders you can write and receive files, and from Photo, Sounds and Images folders you may only receive files, copy files to this folders from PC is impossible. All supported file types you may copy from PC to phone's Others folder, and then you may view or play these files. When connecting with PC via USB cable in internal phone memory you may see only Photo, Music, Others, Text and Video folders, and on external memory card you may see all folders.

Games & Apps **[Menu 6-8]**

In this menu, you can manage the Java applications installed on your phone. You can play or delete downloaded applications, or set the connect option. This menu will connect to the [Menu 1-1], see p. 29.

External Memory **[Menu 6-9]**

This menu allows you to view Videos, Photos, Music, Text, Images, Sounds and Others in your memory card. If the external memory is not available, a pop up message "Please insert external memory" is displayed.

New Fantastic LG

There is mass storage function in P7200. if you connect the USB cable, you can use the phone as a Removable Disk.

You can download MP3 files, and photos, video, txt files etc. this gives you fast access from PC to Phone, by just connecting the USB cable.

Notice

- MASS STORAGE function will only work in idle mode.
- Please do not try to remove the cable while you are downloading files. After you download the files, you need to click "window HW safely remove" on PC  and then disconnect cable.
- When you copy a file to the removable disk, you can see the Main LCD display "transferring". it means MASS STORAGE is working. while "transferring", do not disconnect the cable. if you disconnect the cable while "transferring", data will be broken.
- If you receive a call during MASS STORAGE the call will be rejected but after you safely remove the cable, you will be able to see the missed call.

You can set functions relating to the phone.



Wallpaper [Menu 7-1]

You can select the background pictures in standby mode.

Main LCD [Menu 7-1-1]

Front LCD [Menu 7-1-2]

Default

You can select a picture or an animation of wallpaper by pressing  or .

My folder

You can select a picture or an animation as wallpaper.

Menu Colour [Menu 7-2]

Your phone provides you with 4 menu colour themes. Set the menu colour by scrolling and pressing the left soft key  [Select].

Standby text [Menu 7-3]

If you select **On**, you can edit the text which is displayed in standby mode.

Backlight [Menu 7-4]

You can set the light-up duration of the display.

Network name [Menu 7-5]

If this function is activated, network name will be displayed on main LCD.

Profiles [Menu 8]

In Profiles, you can adjust and customise the phone tones for different events, environments, or caller groups.

There are five preset profiles: **Vibrate only**, **Silent**, **General**, **Loud** and **Headset**. Each profile can be personalised. Press the left soft key [Menu] and select **Profiles** using up/down navigation keys.

Activate [Menu 8-X-1]

1. A list of profiles is displayed.
2. In the Profiles list, scroll to the profile you want to activate and press the left soft key  [Select] or OK key.
3. Then, select Activate.

Personalise [Menu 8-X-2]

Scroll to the desired profile in the Profile list. After pressing the left soft key  or the OK key, select **Personalise**. The profile setting option opens. Set the option as required.

- ▶ **Call alert type:** Set the alert type for incoming calls.
- ▶ **Ring tone:** Select the desired ring tone from the list.
- ▶ **Ring volume:** Set the volume of the ringing tone.



- ▶ **Message alert type:** Set the alert type for messages.
- ▶ **Message tone:** Select the alert tone for messages.
- ▶ **Keypad tone:** Select the desired keypad tone.
- ▶ **Keypad volume:** Set the volume of keypad tone.
- ▶ **Flip tone:** Allows you to set the flip tone.
- ▶ **Effect sound volume:** Set the volume of effect sound.
- ▶ **Power on/off volume:** Set the volume of the ringing tone when switching the phone on/off.
- ▶ **Auto answer:** This function will be activated only when your phone is connected to the handsfree kit.
 - **Off:** The phone will not answer automatically.
 - **After 5 secs:** After 5 seconds, the phone will answer automatically.
 - **After 10 secs:** After 10 seconds, the phone will answer automatically.

Rename

[Menu 8-X-3]

You can rename a profile and give it any name you choose to.

! **Note** **Vibrate only**, **Silent** and **Headset** profiles cannot be renamed.

1. To change the name of a profile, scroll to the profile in the profile list and after pressing the left soft key  or the OK key, select **Rename**.
2. Key in the desired name and press the OK key or the left soft key  [OK].

Tools [Menu 9]

Favourites

[Menu 9-1]

This option allows you to add your own favourites to the list already provided. Once you create your own menu, you can access the desired function quickly in the idle screen by pressing the up navigation key.

Note The menu of SMS, MMS and MP3 is already provided in your own favourites.

Alarm clock

[Menu 9-2]

You can set up to 5 alarm clocks to go off at a specified time.

1. Select **On** and enter the alarm time you want.
2. Select the repeat period: **Once, Mon~Fri, Mon~Sat, Everyday.**
3. Select the alarm tone you want and press **[OK]**.
4. Edit the alarm name and press **[OK]**.

Bluetooth

[Menu 9-3]

Bluetooth enables compatible mobile devices, peripherals and computers that are in close proximity to communicate directly with each other without wires. This handset supports built-in Bluetooth connectivity, which makes it possible to connect them with compatible Bluetooth headsets, computer

applications and so on.

Note

- If you use a pcsync via Bluetooth, you can exchange the data within only the phonebook.
- When you receive data from another Bluetooth device, the phone requests for a confirmation. After confirming the transfer, the file will be copied in your phone.
- Depending on the file type, it will be stored in the following folders:
 - **MP3 (.mp3, mp4, aac, m4a, wma):** Music folder.
 - **Video (.3GP):** video folder.
 - **Phonebook contacts (.VCF):** Phonebook.
 - **Text (.txt):** Text folder.
 - **Other files (*.*):** File storage folder.
- Supported Bluetooth software (Bluetooth stacks) for DUN: WIDCOMM Bluetooth for Windows 1.4 and 3.0

Paired devices

[Menu 9-3-1]

You can view all devices which are compatible with Bluetooth phone.

Note Due to a compatibility problem, some devices may not support this function.

Handsfree devices

[Menu 9-3-2]

You can view the list of handsfree devices which is compatible with Bluetooth phone.

If you have entered Paired devices or Handsfree devices, you will see the following options in both those menus.

- ▶ **Connect/Disconnect:** Allows you to connect to other Bluetooth devices.
- ▶ **Add new:** Allows you to search for new Bluetooth device.
- ▶ **Assign name:** Allows you to change the name of Bluetooth device and how its displayed on the handset.
- ▶ **Set as authorised/Set as unauthorised:** Allows you to set the authorised connection between each Bluetooth devices.
- ▶ **All service:** Allows you to view all services which are supported by a Bluetooth device.
- ▶ **Delete:** Allows you to delete the Bluetooth device.
- ▶ **Delete all:** Allows you to delete all Bluetooth devices.

Settings **[Menu 9-3-3]**

You can register a new device which is compatible with Bluetooth. If you already have added the device, you can search it after entering a password.

▶ **Set Bluetooth**

You can activate or cancel Bluetooth function.

▶ **My handset's visibility**

You can set the function that your phone is visible on the other Bluetooth devices.

▶ **My handset's name**

You can set the name of Bluetooth device. The default name is LG P7200.

Supported services **[Menu 9-3-4]**

You can see the Bluetooth service list, like a File transfer, Image printing, Pc sync and so on.

Modem **[Menu 9-4]**





You can access the network services through the Modem. If you want to use PCsync, Contents banks, Internet Cube, you should access the menu and activate the modem and then plug in the USB cable.

Calculator **[Menu 9-5]**

This contains the standard functions such as +, -, x, ÷ : **Addition, Subtraction, Multiplication, and Division.**





Tools [Menu 9]

Furthermore, you can use the various function of calculator such as **+/-, sin, cos, tan, log, in, exp, sqrt.**

1. Input the numbers by pressing numeric keys.
2. Use a navigation key to select a sign for calculation.
3. Then input the numbers.
4. Press  key to view the result.
5. To input the decimal number, press  key. If you press  key, you can enter ().
6. To end **Calculator**, press the right soft key  [Back].



Unit converter [Menu 9-6]

This converts any measurement into a unit you want. There are 9 types that can be converted into units: **Currency, Surface, Length, Weight, Temperature, Volume, Velocity, Shoes and Clothes.**

1. You can select one of four unit types by pressing  [Select] key.
2. Select the unit you want to convert by pressing  and . It's impossible to input "-" symbol in unit converter.
3. Select the standard value by using , .

World time [Menu 9-7]

You can view clocks of the world's major cities.

1. Select the city belonged to the time zone by pressing ,  key.
2. You can set the current time to the city time you select by pressing the left soft key  [Set].

SIM-Menu [Menu 9-8]

This menu depends on SIM and the network services.

! Note

- In case the SIM card support SAT(i.e. SIM Application Toolkit) services, this menu will be the operator specific service name stored on the SIM card.
- In case the SIM card does not support SAT services, this menu will be Profiles.

You can access various WAP (Wireless Application Protocol) services such as banking, news, weather reports and flight information. These services are specially designed for mobile phones and they are maintained by WAP service providers.

Check the availability of WAP services, pricing and tariffs with your network operator and/or the service provider whose service you wish to use. Service providers will also give you instructions on how to use their services.



Once connected, the homepage is displayed. The content depends on the service provider. To exit the browser at any time, press the () key. The phone will return to the idle menu.

Navigating with the WAP browser

You can surf the Internet using either the phone keys or the WAP browser menu.

Using the phone keys

When surfing the Internet, the phone keys function differently to phone mode.

	Description
	Scrolls each line of the content area
	Returns to the previous page
	Selects options and confirms actions

Using the WAP browser menu

There are various menu options available when surfing the Mobile Web.

Note The WAP browser menus may vary, depending on your browser version.

Home

[Menu *-1]

Connects to a homepage. The homepage will be the site which is defined in the activated profile. It will be defined by the service provider if you have not defined it in the activated profile.

Bookmarks

[Menu *-2]

This menu allows you to store the URL of favourite web pages for easy access at a later time.

To create a bookmark

1. Press the left soft key  [Options].
2. Select Add new and press the OK key.
3. After entering the desired URL and title, press the OK key.

Browser [Menu *]

After selecting a desired bookmark, the following options are available.

- ▶ **Connect:** Connects to the selected bookmark.
- ▶ **Add new:** Select this to create a new bookmark.
- ▶ **Edit:** You can edit the URL and/or the title of the selected bookmark.
- ▶ **Delete:** Deletes the selected bookmark.
- ▶ **Delete all:** Deletes all the bookmarks.

Go to URL [Menu *-3]

You can connect directly to the site you want. After entering a specific URL, press the OK key.

Settings [Menu *-4]

You can set the profile, cache, cookie and security related to internet service.

Profiles [Menu *-4-1]

A profile is the network information used to connect to the Internet.

There are default profiles for some operators, stored in phone memory. It's impossible to rename default profiles.

Each profile has submenus as follows:

- ▶ **Activate:** Activates the selected profile.
- ▶ **Settings:** Use this to edit and change WAP settings for the selected profile.
 - **Homepage:** This setting allows you to enter the address (URL) of a site you want to use as homepage. You do not need to type http:// at the front of each URL as the WAP Browser will automatically add it.
 - **Bearer:** You can set the bearer data service.
 - 1 Data/2 GPRS
 - **Data settings:** Appears only if you select Data Settings as a Bearer/service.
 - Dial number:** Enter the telephone number to dial to access your WAP gateway.
 - User ID:** The users identity for your dial-up server (and NOT the WAP gateway).
 - Password:** The password required by your dial-up server (and NOT the WAP gateway) to identify you.
 - Call type:** Select the type of data call : Analogue of Digital (ISDN).
 - Linger time:** You need to enter timeout period. After entering that, the WAP navigation service will be unavailable if any data is not input or transferred.

- Call speed:** The speed of your data connection; 9600 or 14400 (Depends on Operator)
- **GPRS settings:** The service settings are only available when GPRS is chosen as a bearer service.
APN: Input the APN of the GPRS.
User ID: The users identify for your APN server.
Password: The password required by your APN server.
 - **Proxy settings**
Proxy: Activates or cancels proxy.
IP address: Input the IP address of the Proxy server you access.
Port: Input the Proxy Port.
 - **DNS settings**
Primary server: Input the IP address of the primary DNS server you access.
Secondary server: Input the IP address of the secondary DNS server you access.
 - ▶ **Rename:** You can change the profile name.
 - ▶ **Add new:** You can add a new profile.
 - ▶ **Delete:** Deletes the selected profile from the list.

Cache [Menu *-4-2]

The information or services you have accessed are saved in the cache memory of the phone.

Cookie [Menu *-4-3]

The information or services you have accessed are saved in the cache memory of the phone.

Clear cache [Menu *-4-4]

Removes all context saved in cache.

❗ **Note** A cache is a buffer memory, which is used to save data temporarily.

Clear cookie [Menu *-4-5]

Removes all context saved in cookie.

Security [Menu *-4-6]

A list of the available certification is shown.

- ▶ **Authority:** You can see the list of authority certificates that have been stored in your phone.
- ▶ **Personal:** You can see the list of personal certificates that have been stored in your phone.

Call register [Menu 0]

You can check the record of missed, received, and dialled calls only if the network supports the Calling Line Identification (CLI) within the service area.

The number and name (if available) are displayed together with the date and time at which the call was made. You can also view call times.

Missed calls [Menu 0-1]

This option lets you view the last 10 unanswered calls.

You can also:

- View the number if available and call it, or save it in the Address Book
- Enter a new name for the number and save both in the Address Book
- Send a message to this number
- Delete the call from the list

Received calls [Menu 0-2]

This option lets you view the last 10 incoming calls. You can also:

- View the number if available and call it or save it in the Address Book
- Enter new name for the number and save both in the Address Book

- Send a message to this number
- Delete the call from the list

Dialled calls [Menu 0-3]

This option lets you view the last 20 outgoing calls (called or attempted).

You can also:

- View the number if available and call it or save it in the Address Book
- Enter new name for the number and save both in the Address Book
- Send a message to this number
- Delete the call from the list

All calls [Menu 0-4]

You can view all lists of outgoing or incoming calls.

Delete recent calls [Menu 0-5]

Allows you to delete Missed calls and Received calls lists. You can delete Dialled calls and All calls lists at one time.

Call charges [Menu 0-6]

Call duration [Menu 0-6-1]

Allows you to view the duration of your incoming and outgoing calls. You can also reset the call times.

The following timers are available:

- ▶ **Last call:** Length of the last call.
- ▶ **All calls:** Total length of all calls made and incoming calls since the timer was last reset.
- ▶ **Received calls:** Length of the incoming calls.
- ▶ **Dialled calls:** Length of the outgoing calls.
- ▶ **Reset all:** Allows you to reset the timers of all calls by pressing the left soft key  [Yes].

Call costs [Menu 0-6-2]

Allows you to check the cost of your last call, all calls, remaining and reset the cost. To reset the cost, you need to know your PIN2 code.

Settings [Menu 0-6-3]

(SIM Dependent)

- ▶ **Set tariff:** You can set the currency type and the unit price. Contact your service providers to obtain charging unit prices. To select the currency or unit in this menu, you need the PIN2 code.

- ▶ **Set credit:** This network allows you to limit the cost of your calls by selected charging units. If you select **Read**, the number of remaining unit is shown. If you select **Change**, you can change your change limit.

- ▶ **Auto display:** This network service allows you to see automatically the cost of your last calls. If set to **On**, you can see the last cost when the call is released.

GPRS information [Menu 0-7]

You can check the amount of data transferred over the network through the GPRS information option. In addition, you can also view how much time you are online.

Call duration [Menu 0-7-1]

You can check the duration of **Last call** and **All calls**. You can also reset the call timers.

Data volumes [Menu 0-7-2]

You can check The **Sent**, **Received** or **All** data volumes and **Reset all**.

Settings [Menu #]

Date & Time

[Menu #-1]

You can set functions relating to the date and time.

Set date

[Menu #-1-1]

► Set date

You can enter the current date.

► Date format

You can set the Date format such as DD/MM/YYYY, MM/DD/YYYY, YYYY/MM/DD.
(D: Day / M: Month / Y: Year)

Set time

[Menu #-1-2]

► Set time

You can enter the current time.

► Time format

You can set the time format between 24-hour and 12-hour.

Language

[Menu #-2]

You can change the language for the display texts in your phone. This change will also affect the Language Input mode.

Call

[Menu #-3]

You can set the menu relevant to a call by pressing [Select] in the Setting menu.

Call divert

[Menu #-3-1]

The Call divert service allows you to divert incoming voice calls, fax calls, and data calls to another number. For details, contact your service provider.

► All voice calls

Diverts voice calls unconditionally.

► If busy

Diverts voice calls when the phone is in use.

► If no reply

Diverts voice calls which you do not answer.

► If out of reach

Diverts voice calls when the phone is switched off or out of coverage.

► All data calls

Diverts to a number with a PC connection unconditionally.

► All fax calls

Diverts to a number with a fax connection unconditionally.

► **Cancel all**

Cancels all call divert service.

The submenus

Call divert menus have the submenus shown below.

• **Activate**

Activate the corresponding service.

To voice mail centre

Forwards to message centre. This function is not shown at All data calls and All fax calls menus.

To other number

Inputs the number for diverting.

To favourite number

You can check recent 5 diverted numbers.

• **Cancel**

Deactivate the corresponding service.

• **View status**

View the status of the corresponding service.

Answer mode

[Menu #-3-2]

► **Flip open**

If you select this menu, you can receive an incoming call when you open the flip.

► **Any key**

If you select this menu, you can receive a call by pressing any key except  [End] key.

► **Send key only**

If you select this menu, you can receive a call by only pressing  [Send] key.

Send my number

[Menu #-3-3]

(network and subscription dependent)

► **Set by network**

If you select this, you can send your phone number depending on two line service such as line 1 or line 2.

► **On**

You can send your phone number to another party. Your phone number will be shown on the receiver's phone.

► **Off**

Your phone number will not be shown.

Call waiting

[Menu #-3-4]

(network dependent)

► **Activate**

If you select Activate, you can accept a waiting (receiving) call.

Settings [Menu #]

► **Cancel**

If you select **Cancel**, you cannot recognize the waiting (receiving) call.

► **View status**

Shows the status of Call waiting.

Minute minder [Menu #-3-5]

If you select **On**, you can check the call duration by a beep sound given every minute during a call.

Auto redial [Menu #-3-6]

► **On**

When this function is activated, the phone will automatically try to redial in the case of failure to connect a call.

► **Off**

Your phone will not make any attempts to redial when the original call has not connected.

Security [Menu #-4]

PIN code request [Menu #-4-1]

In this menu, you can set the phone to ask for the PIN code of your SIM card when the phone is switched on.

If this function is activated, you'll be requested to enter the PIN code.

1. Select PIN code request in the security settings menu, and then press  [Select].
2. Set **Enable/Disable**
3. If you want to change the setting, you need to enter PIN code when you switch on the phone.
4. If you enter wrong PIN code more than 3 times, the phone will lock out. If the PIN is blocked, you will need to key in PUK code.
5. You can enter your PUK code up to 10 times. If you put wrong PUK code more than 10 times, you can not unlock your phone. You will need to contact your service provider.

Handset lock [Menu #-4-2]

You can use a security code to avoid unauthorized use of the phone. Whenever you switch on the phone, the phone will request security code if you set phone lock to **When switch on**.

If you set phone lock to **When SIM changed**, your phone will request security code only when you change your SIM card.

Call barring

[Menu #-4-3]

The Call barring service prevents your phone from making or receiving certain category of calls. This function requires the call barring password. You can view the following submenus.

▶ All outgoing calls

The barring service for all outgoing calls.

▶ Outgoing international

The barring service for all outgoing international calls.

▶ Outgoing international when roaming

The barring service for all international outgoing calls except home network.

▶ All incoming

The barring service for all incoming calls.

▶ Incoming when roaming

The barring service for all incoming calls when roaming.

▶ Cancel all

You can cancel all barring services.

▶ Change password

You can change the password for Call Barring Service.

The submenus:

• Activate

Allows to request the network to set call restriction on.

• Cancel

Set the selected call restriction off.

• View status

View the status whether the calls are barred or not.

Fixed dial number

[Menu #-4-4]

(SIM dependent)

You can restrict your outgoing calls to selected phone numbers. The numbers are protected by your PIN2 code.

▶ Enable

You can restrict your outgoing calls to selected phone numbers.

▶ Disable

You can cancel fixed dialling function.

▶ Number list

You can view the number list saved as Fixed dial number.

Settings [Menu #]

Change codes

[Menu #-4-5]

PIN is an abbreviation of Personal Identification Number to prevent use by unauthorized person. You can change the access codes: **Security code, PIN code, PIN2 code.**

1. If you want to change the Security code/PIN1/PIN2 code input your original code, and then press  [OK].
2. Input new Security code/PIN1/PIN2 code and verify them.

Network

[Menu #-5]

You can select a network which will be registered either automatically or manually. Usually, the network selection is set to **Automatic.**

Network selection

[Menu #-5-1]

You can select a network type.

Automatic

If you select Automatic mode, the phone will automatically search for and select a network for you. Once you have selected "Automatic", the phone will be set to "Automatic" even though the power is off and on.

Manual

The phone will find the list of available networks and show you them. Then you can select the network which you want to use if this network has a roaming agreement with your home network operator. The phone let you select another network if the phone fails to access the selected network.

Preferred

You can set a list of preferred networks and the phone attempts to register with first, before attempting to register to any other networks. This list is set from the phone's predefined list of known networks.

Band selection

[Menu #-5-2]

EGSM/DCS

According to depending on Network situation, you can select EGSM/DCS.

EGSM/PCS

According to depending on Network situation, you can select EGSM/PCS.

GPRS Attach

[Menu #-6]

You can set GPRS service depending on various situations.

Switch on

[Menu #-6-1]

If you select this menu, the phone is automatically registered to a GPRS network when you switch the phone on. Starting a WAP or PC dial-up application created the connection between phone and network and data transfer is possible. When you end the application, GPRS connection is ended but the registration to the GPRS network remains.

When needed

[Menu #-6-2]

If you select this menu, the GPRS connection is established when you connect a WAP service and closed when you end the WAP connection.

Memory status

[Menu #-7]

You can check free space and memory usage of each repository, Internal memory, Multimedia memory and External memory. You can go to each repository menu.

Reset settings

[Menu #-8]

You can initialize all factory defaults. You need Security code to activate this function.

- ▶ **Restore default settings:** Allows you to restore default settings.
- ▶ **Clear multimedia memory:** Allows you to format the multimedia memory and create a default directory.
- ▶ **Clear external memory:** Allows you to format the external memory and create default directory.

There are various accessories for your mobile phone. You can select these options according to your personal communication requirements.



Travel Adapter

This charger allows you to charge the battery while away from home or your office.



Standard Battery

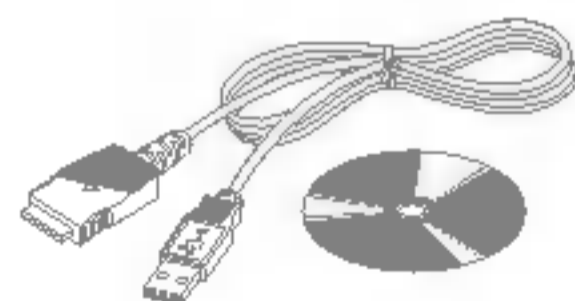

Data cable/CD

You can connect your phone to PC to exchange the data between them.



Hands free ear-microphone and music player controller combo

Stereo headset

Controller: Answer & End button, music player control, volume control, Hold button and microphone.

After connecting the headset and the controller, plug the end of controller into the headset jack on the left side of the phone.

! Note

- Always use genuine LG accessories.
- Failure to do this may invalidate your warranty.
- Accessories may be different in different regions; please check with our regional service company or agent for further enquires.

General

Product name : P7200

System : GSM 900 / DCS 1800 / PCS 1900

Ambient Temperatures

Max. : +55°C

Min : -10°C

Declaration of Conformity



LG Electronics

Name

LG Electronics Inc

Address

LG Electronics Inc, LG Twin Towers
20, Yeouido-dong, Yeongdeungpo-gu, Seoul, Korea 150-721

Product Name

E-GSM 900 / DCS 1800 / PCS 1900 Trial Band Terminal Equipment

Model Name

P7200

Trade Name

LG

CE 0168

R&TTE Directive 1999/5/EC

EN 301 489-7 : 2002

EN 60950 : 2001

EN 50360 : 2001

3GPP TS 51.010-1,

Selection according to requirements of EN 301 511, v7.0.1

The conformity to above standards is verified by 7Layers and Phoenix with Certificate No.(05-111075) and GSM test report (no.4_LGE_0905_GSM_1), EMC test report(no. HCT-C05-0501), safety test report(no. ITYA0108825M1) and SAR test report(no. TCMA0813254)

I hereby declare under our sole responsibility that the product mentioned above to which this declaration relates complies with the above mentioned standards and Directives

Name

Issued Date

JIn Seog, Kim / Director 10.June.2004

LG Electronics Inc, Amsterdam Office
Veluwezoom 15, 1327 AE Almere, The Netherlands
Tel : +31 - 36-547 - 8940, e-mail : sookim @ lge.com

Signature of representative