



Colour Television

OWNER'S MANUAL

Please read this manual carefully before operating your set.
Retain it for future reference.
Record model number and serial number of the set.
See the label attached on the back cover and quote this
information to your dealer when you require service.

Model number :
Serial number :

P/NO : 3828VA0376A (MC019A, 090A/D TX)

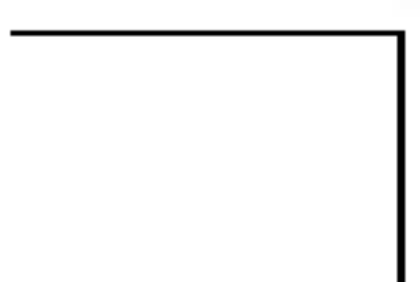

Contents

Installation	3
Location and function of controls	4
Remote control handset	
Battery installation	
Front panel / Side panel	
Basic operation	7
On and off / Programme selection	
Volume adjustment / Quick view	
Mute function / Auto Demonstration	
TV Swivel function (option)	
On screen language selection (option)	
On screen menus	8
Menu selection	
Setting up TV stations	9
Auto programme tuning	
Manual programme tuning	
Fine Tuning / Programme edit	
Favorite programme	
Calling the programme table	
Picture adjustment	14
PSM (Picture Status Memory)	
Picture adjustment / Eye (option)	
Turbo picture selection (option)	
Sound adjustment (option)	16
SSM (Sound Status Memory)	
Balance adjustment	
Turbo sound selection (option)	
Sound output selection	
Stereo/Dual reception (option)	
NICAM reception (option)	
Other functions	19
TV and AV modes	
Auto AV switching (option)	
Child lock / Auto sleep / Blue back (option)	
AVL (Auto Volume Leveler) (option)	
CSM (Colour Status Memory) / Sleep timer	
Game (option)	21
Block & Balloon (option)	
Cricket & Car racing (option)	
Timer (option)	22
Off timer / On timer	
Teletext (option)	23
Switch on/off	
SIMPLE text / TOP text (option)	
FASTEXT / Special teletext functions	
Connection of external equipment	26
Aerial socket	
Audio(or Audio-L/R)/Video in/out sockets (option)	
Euro scart socket (option)	
Headphone socket (option)	
Troubleshooting check list	Back cover

Installation

Power

This set operates on an AC mains supply, the voltage is as indicated on the label on the back cover. Never apply DC power to the set. In the event of thunderstorms or powercuts, please pull out the aerial and mains plugs.

Warning

To prevent fire or shock hazard, do not expose the set to rain or moisture.

Service

Never remove the back cover of the set as this can expose you to very high voltage and other hazards. If the set does not operate properly, unplug it and call your dealer.

Aerial

Connect the aerial cable to the socket marked 175Ω on the back cover. For the best reception an outdoor aerial should be used.

Location

Position your set so that no bright light or sunlight falls directly onto the screen. Care should be taken not to expose the set to any unnecessary vibration, moisture, dust or heat. Also ensure that the set is placed in a position to allow a free flow of air. Do not cover the ventilation openings on the back cover.

Location and function of controls

All the functions can be controlled with the remote control handset. Some functions can also be adjusted with the buttons on the front panel of the set.

Remote control handset

Before you use the remote control handset, please install the batteries. See the next page.

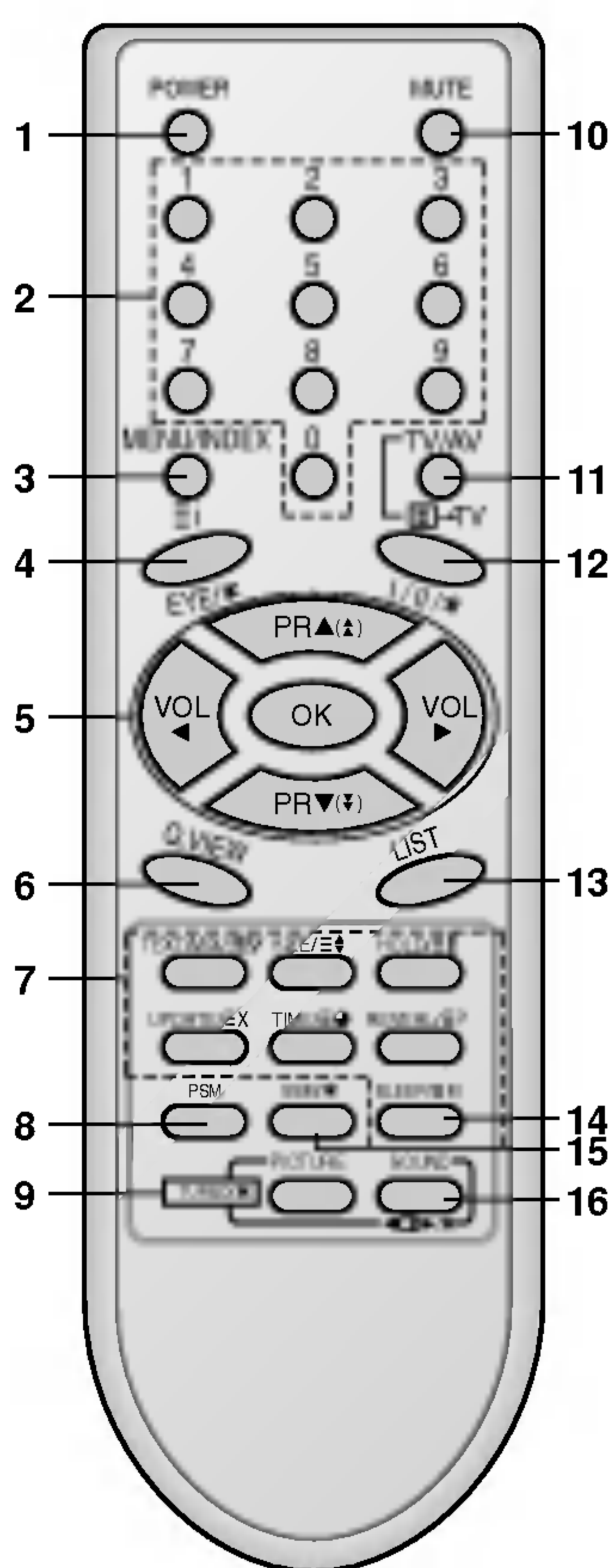

1. **POWER**
switches the set on from standby or off to standby.
2. **NUMBER BUTTONS**
switches the set on from standby or directly select a number.
3. **MENU (or INDEX)**
selects a menu.
selects an index page in the teletext mode (only TELETEXT models).
4. **EYE/* (option)**
switches the eye function on or off.
5. **▲ (▲) / ▼ (▼) (Programme Up/Down)**
selects a programme or a menu item.
switches the set on from standby.
scans programmes automatically.
- ◀ / ▶ (Volume Up/Down)**
adjusts the volume.
adjusts menu settings.
- OK**
accepts your selection or displays the current mode.
6. **Q.VIEW**
returns to the previously viewed programme.
selects a favorite programme.
7. **TELETEXT BUTTONS (option)**
These buttons are used for teletext.
For further details, see the 'Teletext' section.
8. **PSM (Picture Status Memory)**
recalls your preferred picture setting.
9. **TURBO PICTURE / SOUND BUTTON (option)**
selects Turbo picture and sound.

(With TELETEXT)

Location and function of controls

- 10. MUTE**
switches the sound on or off.
- 11. TV/AV**
selects TV or AV mode.
clears the menu from the screen.
switches the set on from standby.
- 12. I/II/* (option)**
selects the language during dual language broadcast. (option)
selects the sound output.
- 13. LIST**
displays the programme table.
- 14. SLEEP**
sets the sleep timer.
- 15. SSM/* (option) (Sound Status Memory)**
recalls your preferred sound setting.
- 16. SURROUND ($\langle \circ \rangle / \star$) (option)**
selects surround sound.

*** : No function**

COLOURED BUTTONS : These buttons are used for teletext (only TELETEXT models) or programme edit.

Battery installation

The remote control handset is powered by two AAA type batteries. To load the batteries, turn the remote control handset over and open the battery compartment. Install two batteries as indicated by the polarity symbols (+ and -) marked inside the compartment.

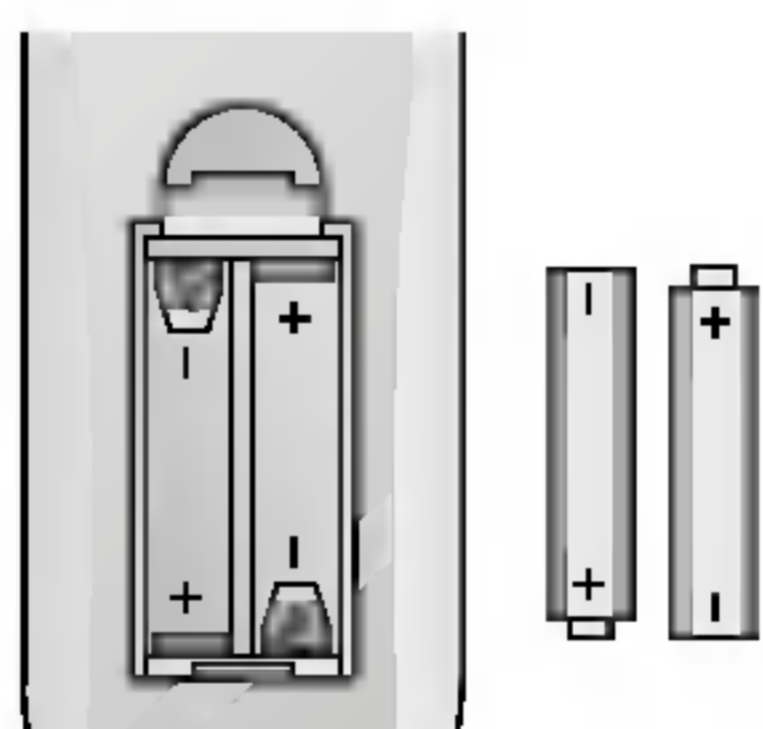

Note : To avoid damage from possible battery leakage, remove the batteries if you do not plan to use the remote control handset for an extended period of time.

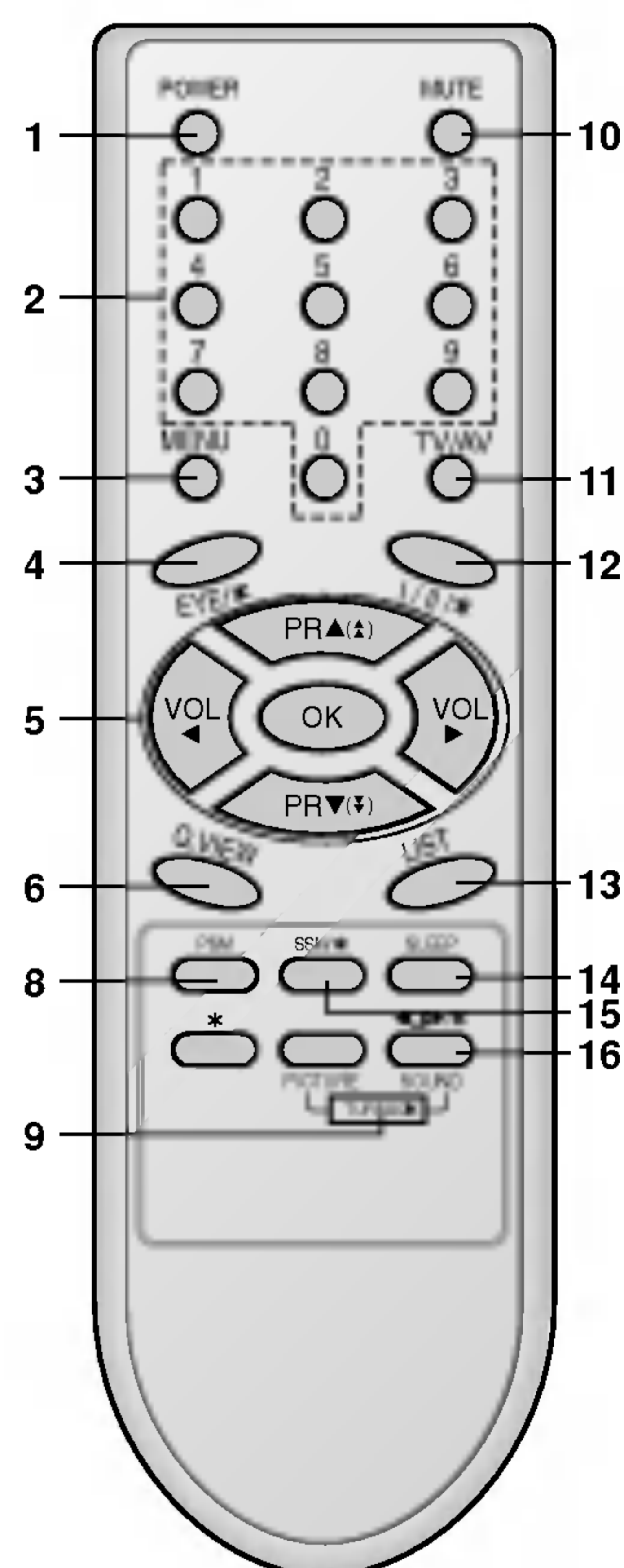

(Without TELETEXT)

Location and function of controls

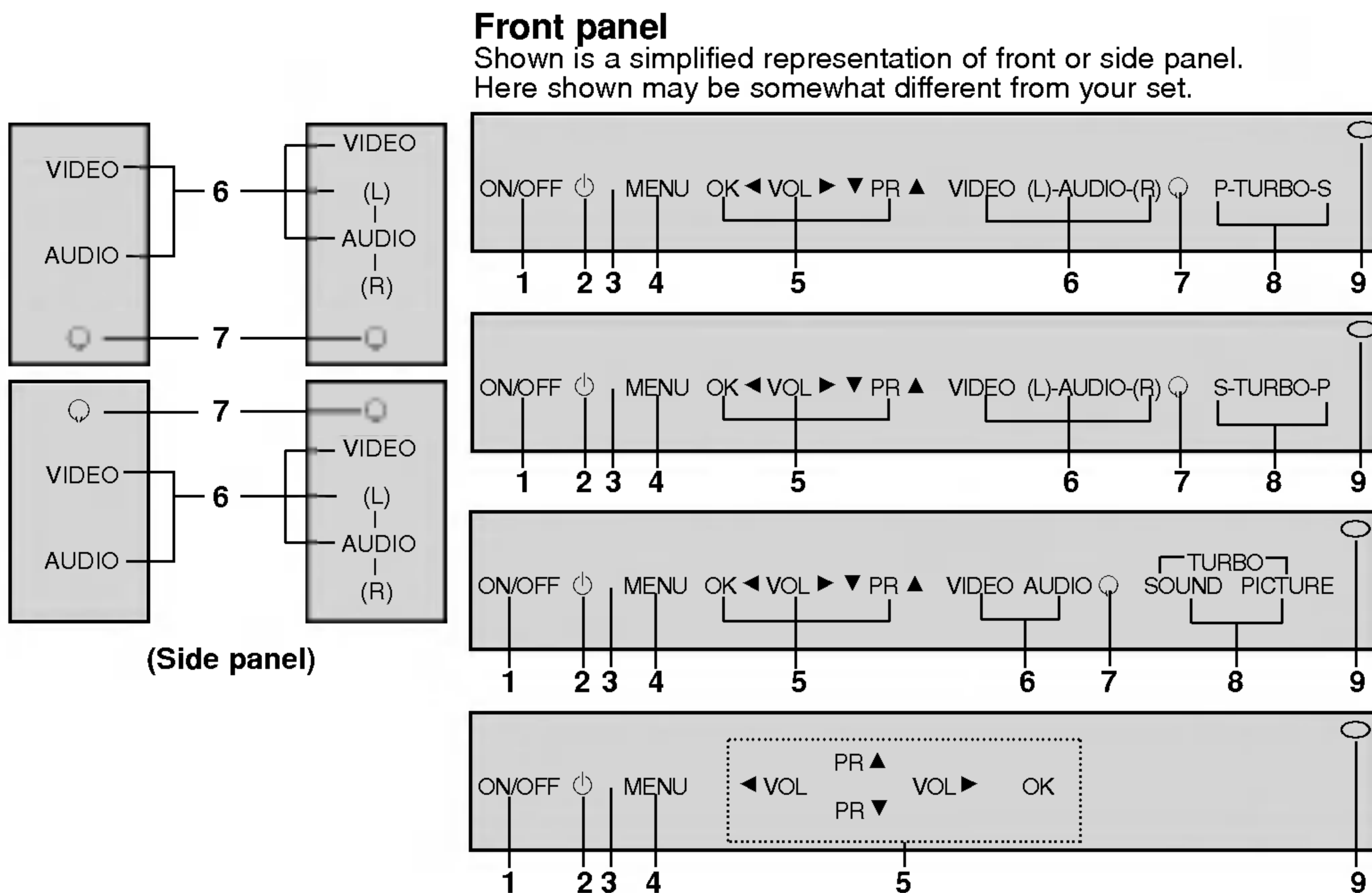

1. **MAIN POWER (ON/OFF)**
switches the set on or off.
2. **POWER/STANDBY INDICATOR**
illuminates brightly when the set is in standby mode.
dims when the set is switched on.
blinks when signal is input from the remote control.
3. **REMOTE CONTROL SENSOR**
4. **MENU**
selects a menu.
5. **OK**
accepts your selection or displays the current mode.
◀ / ▶ (Volume Up/Down)
adjusts the volume.
adjusts menu settings.
▲ / ▼ (Programme Up/Down)
selects a programme or a menu item.
switches the set on from standby.
6. **AUDIO(or AUDIO-L/R)/VIDEO IN SOCKETS (AV) (option)**
Connect the audio/video out sockets of external equipment to these sockets.
Note :if both the input jacks on the front/side panel and back panel have been connected to external equipments simultaneously, only the input jacks on the front/side panel can be received.
7. **HEADPHONE SOCKET (option)**
Connect the headphone plug to this socket.
8. **TURBO SOUND/PICTURE (option)**
switches Turbo sound or Turbo picture on or off.
9. **EYE (option)**
adjusts picture according to the surrounding conditions.

Basic operation

On and off

1. Press the main power button to switch the set on.
2. If the set is in standby mode, press the **POWER**, **▲ / ▼**, **TV/AV** or **NUMBER** buttons on the remote control handset to switch it on fully.
3. Press the **POWER** button on the remote control handset.
The set reverts to standby mode.
4. Press the main power button again to switch the set off.

Note : If, while the set is switched on, the mains plug is disconnected the set will switch to standby or power on when the mains plug is replaced in the mains power socket.

Programme selection

You can select a programme number with the **▲ / ▼** or **NUMBER** buttons.

Volume adjustment

Press the **◀ / ▶** button to adjust the volume.

Quick view

Press the **Q.VIEW** button to view the last programme you were watching.

Note : This function works only when **Favorite programme** is set to **Off**. Otherwise each press of this button will select a stored favorite programme.

Mute function

Press the **MUTE** button. The sound is switched off and the display  appears.

You can cancel it by pressing the **MUTE**, **◀ / ▶**, **SSM/***, **I/II/***, **◀○/★** or **TURBO SOUND** button.

Auto Demonstration

To review all the menus programmed in the set, press the **OK** button of the front panel control for about 5 seconds. To stop auto demonstration, press any button of the front panel control and **POWER** button of the remote control.

TV Swivel function (option)

In some models, you can manually turn TV set at left or right direction by 15 or 20 degrees, so that the watching degree is suitable for your position.

Note : Swivel panel is fixed in the hole at the swivel panel on the back of the set by small bar (Swivel fixer). To operate this function, pull it out.

On screen language selection (option)

The menu can be displayed on the screen in desired language. First select your language.

1. Press the **MENU** button to select the Station menu.
2. Press the **▶** button and then **▲ / ▼** button to select **Language**.
3. Press the **▶** button and then **▲ / ▼** button to select your desired language.
All the on screen displays will appear in the selected language.
Press the **OK** or **◀** button to select the station menu.
4. Press the **TV/AV** button to return to normal TV viewing.

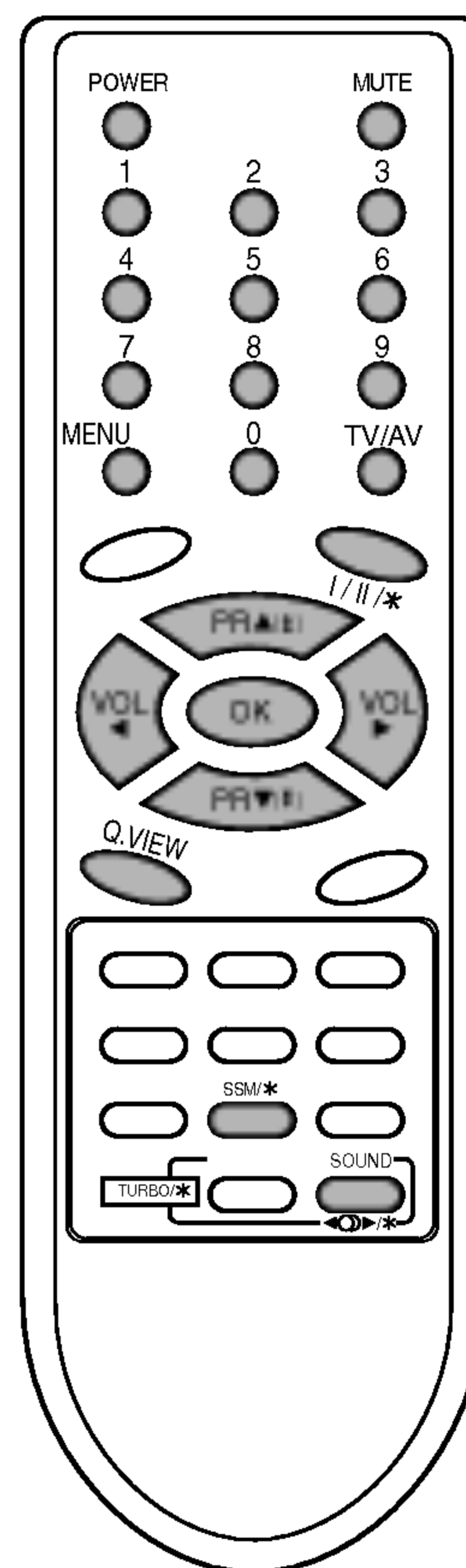

On screen menus

The dialogue between you and your set takes place on screen with an operator menu. The buttons required for the operating steps are also displayed.

Menu selection

1. Repeatedly press the **MENU** button to display each menu.
2. Press the **▶** button and then **▲** / **▼** button to select a menu item.
3. Press the **▶** button to display the sub menu or the pull-down menu.
4. Change the setting of an item in the sub or pull-down menu with **◀** / **▶** or **▲** / **▼**.

You can move to the higher level menu by pressing the **OK** or **◀** button and to move to the lower level menu by pressing the **▶** button.

Note :

- a. In the AV mode, the Station menu is not displayed.
- b. In the teletext mode, menus are not displayed.
- c. In mono models, the Sound menu does not appear.
- d. In some models, the **Normal/Turbo search** will not display, only the **Start** will display in the **Auto programme** menu.
- e. In some models, the **Language** or **Booster** will not display.

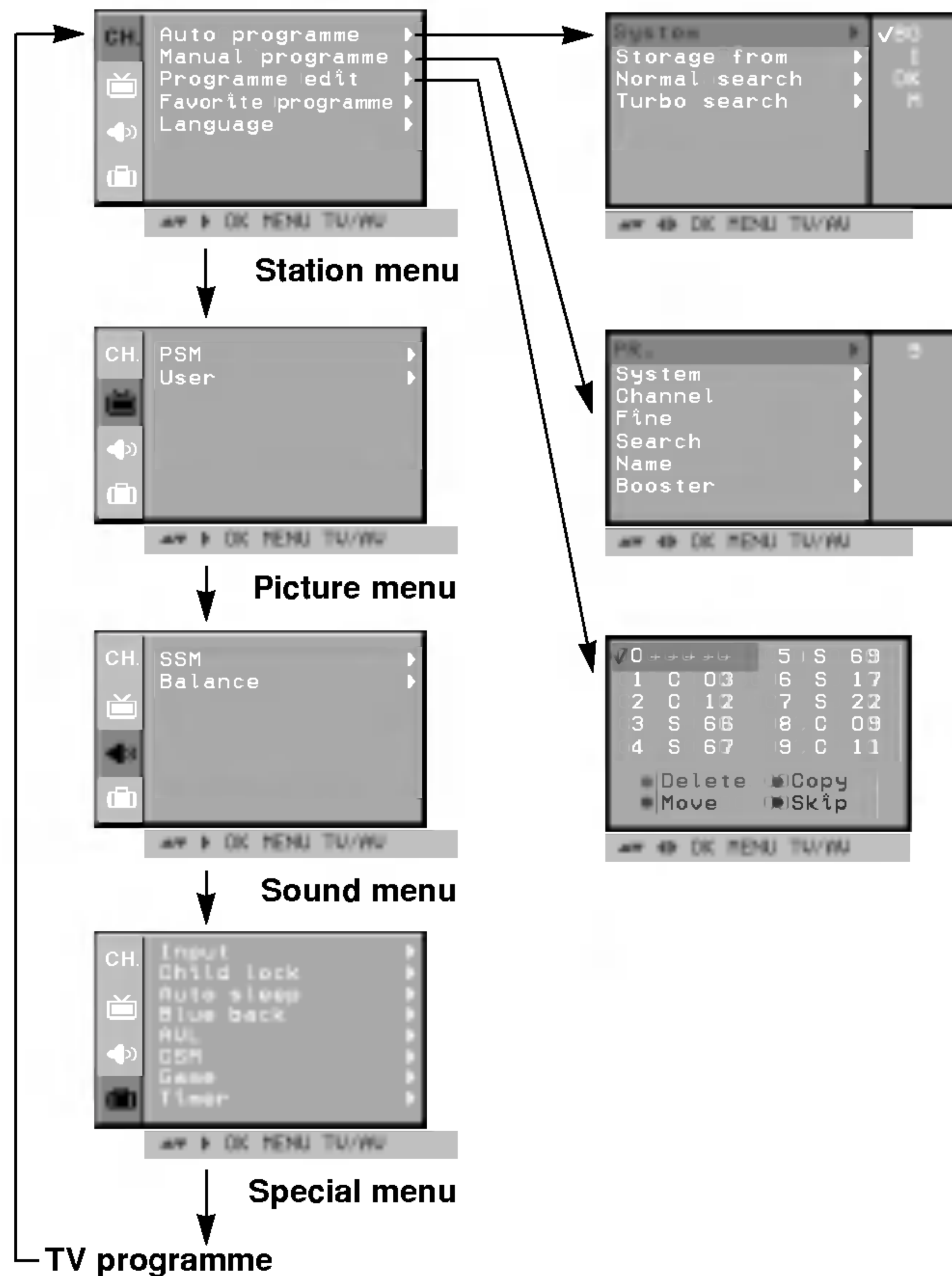
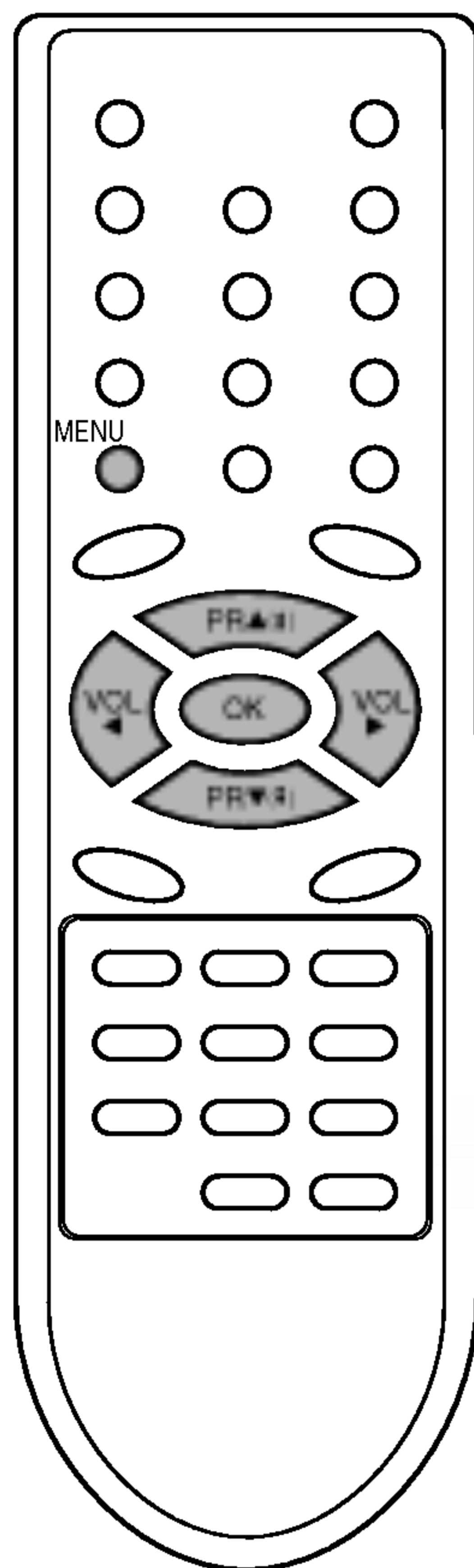

Setting up TV stations

Up to 100 TV stations can be stored by programme numbers (0 to 99). Once you have preset the stations, you will be able to use the ▲ / ▼ or NUMBER buttons to scan the stations you programmed. Stations can be tuned using automatic or manual modes.

Note : In some models up to 200 TV stations can be stored.

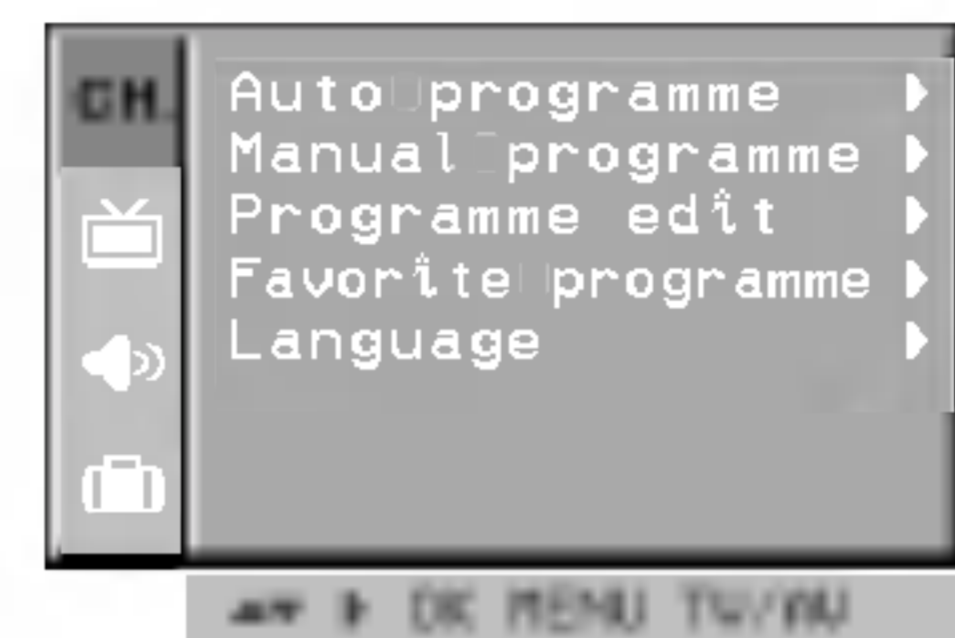

Station Menu

Auto programme tuning

All stations that can be received are stored by this method. It is recommended that you use auto programme during installation of this set.

1. Repeatedly press the **MENU** button to select the Station menu.
2. Press the ► button to select **Auto programme**.
3. Press the ► button to display the **Auto programme** menu.

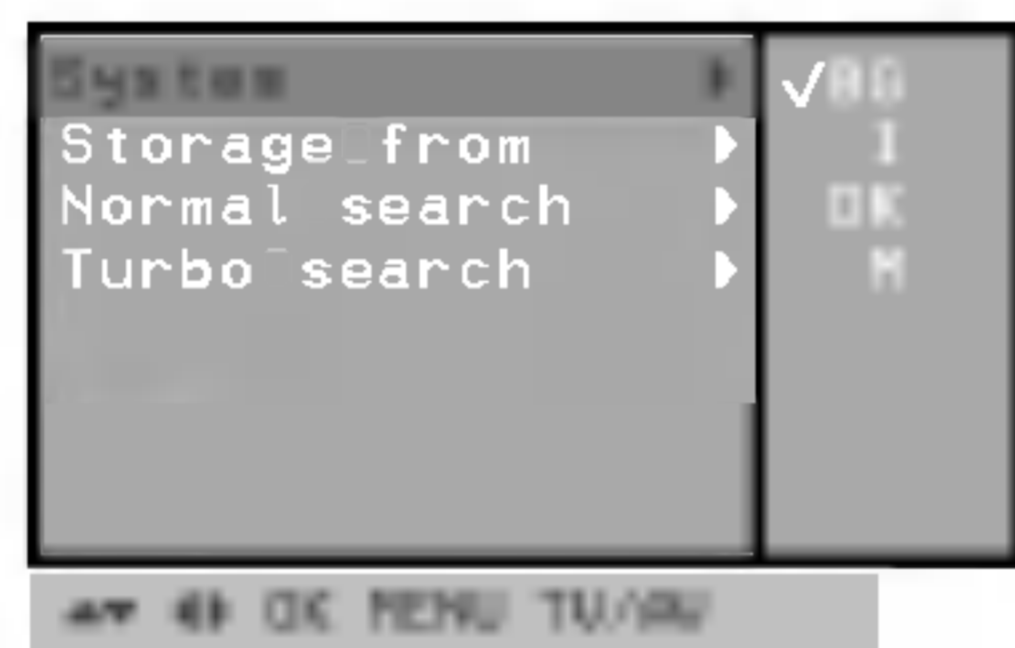

4. Press the ► button. Select a TV system with the ▲ / ▼ button on the **System** pull-down menu;
 - BG** : (Asia/New Zealand/M.East/Africa/Australia)
 - I** : (Hong Kong/South Africa)
 - DK** : (East Europe/China/Africa/CIS)
 - M** : (USA/Korea/Philippines) (option)
5. Press the **OK** or ◀ button.
6. Press the ▲ / ▼ button to select **Storage from**.
7. Press the ► button. Select the beginning programme number with the ◀ / ► button or NUMBER buttons on the **Storage from** pull-down menu. Any number under 10 is entered with a numeric '0' (or '00') in front of it, i.e. '05' (or '005') for 5.
8. Press the **OK** button.
9. Press the ▲ / ▼ button to select **Normal** or **Turbo search**.

Option: In some models, you can only select **Start**.

Note :

- Turbo search** is further faster than **Normal search** and in some models, these searches will automatically store all receivable stations.
 - If the programmed station has poor quality sound, select the system again in the **Manual programme** menu.
10. Press the ► button to begin auto programming.

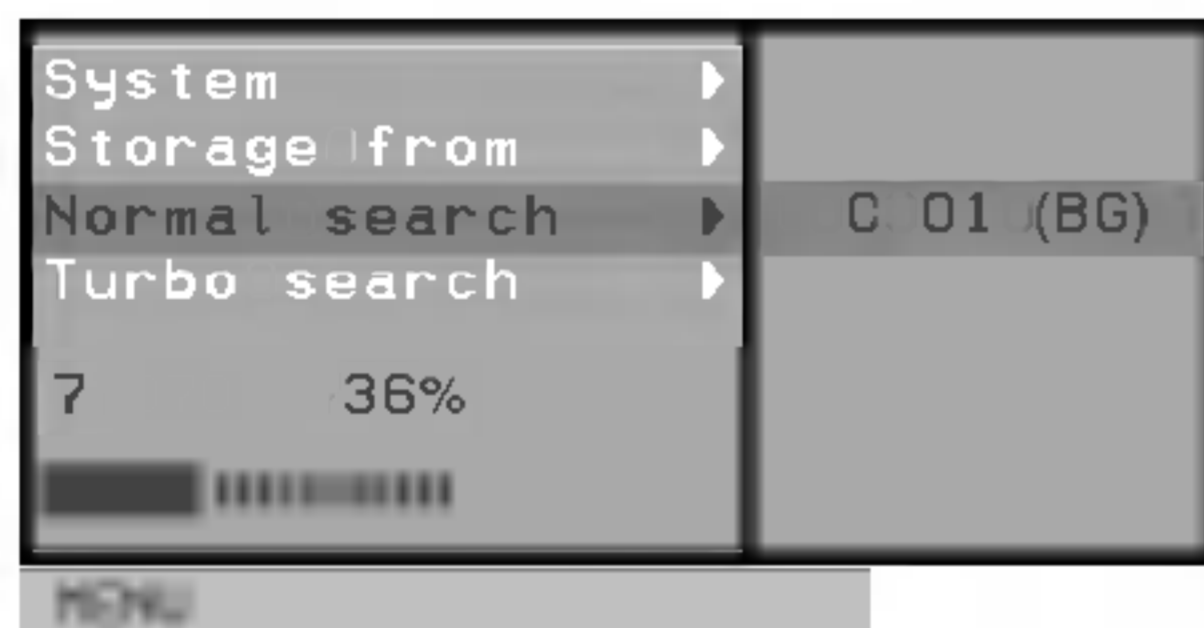

(Normal search)

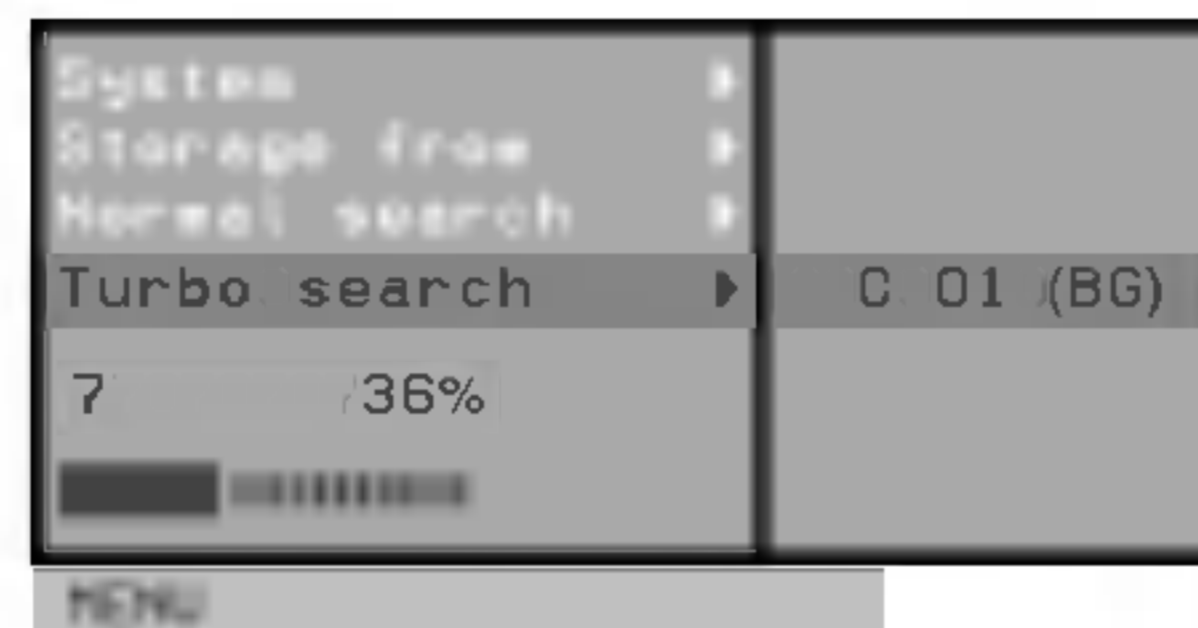

(Turbo search)

All receivable stations are stored.

To stop auto programming, press the **MENU** button.

When auto programming is completed, the **Programme edit** menu appears on the screen. See the 'Programme edit' section to edit the stored programme.

11. Press the **TV/AV** button to return to normal TV viewing.

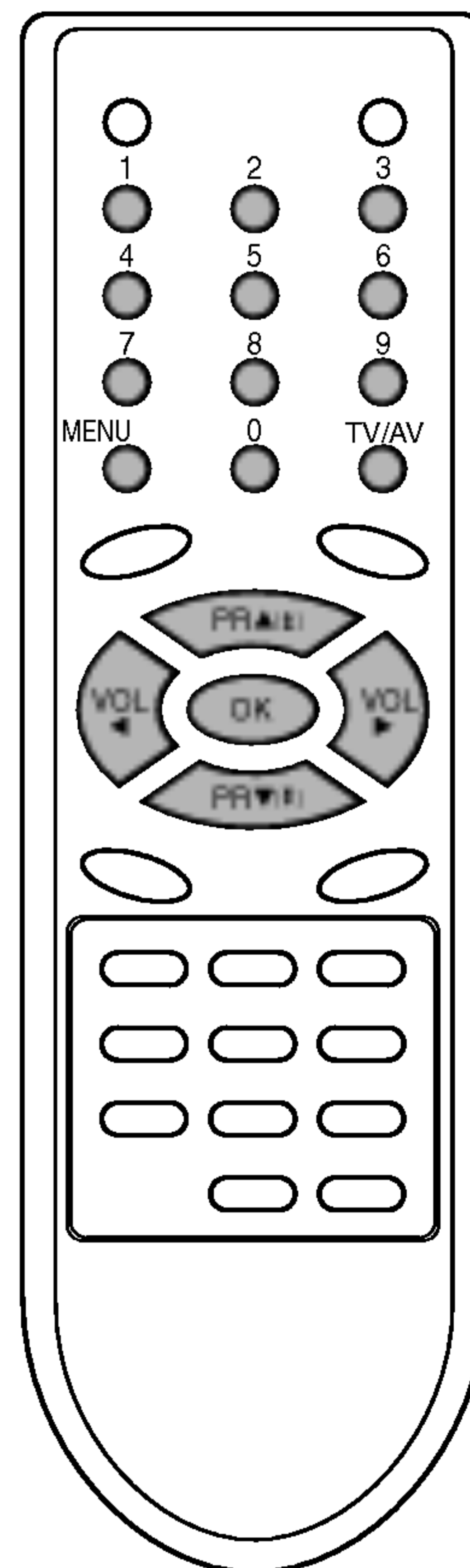

Setting up TV stations



Auto programme scan

To automatically scan the pictures of stored programmes, press the ▲ (▲) or ▼ (▼) button for about 3 seconds. The picture of stored programmes appears on the screen one by one.

To stop auto programme scanning, press any button except VCR buttons.

Manual programme tuning

Manual programme lets you manually tune and arrange the stations in whatever order you desire. Also you can assign a station name with five characters to each programme number.

1. Repeatedly press the **MENU** button to select the Station menu.
2. Press the ► button and then ▲ / ▼ button to select **Manual programme**.
3. Press the ► button to display the **Manual programme** menu.

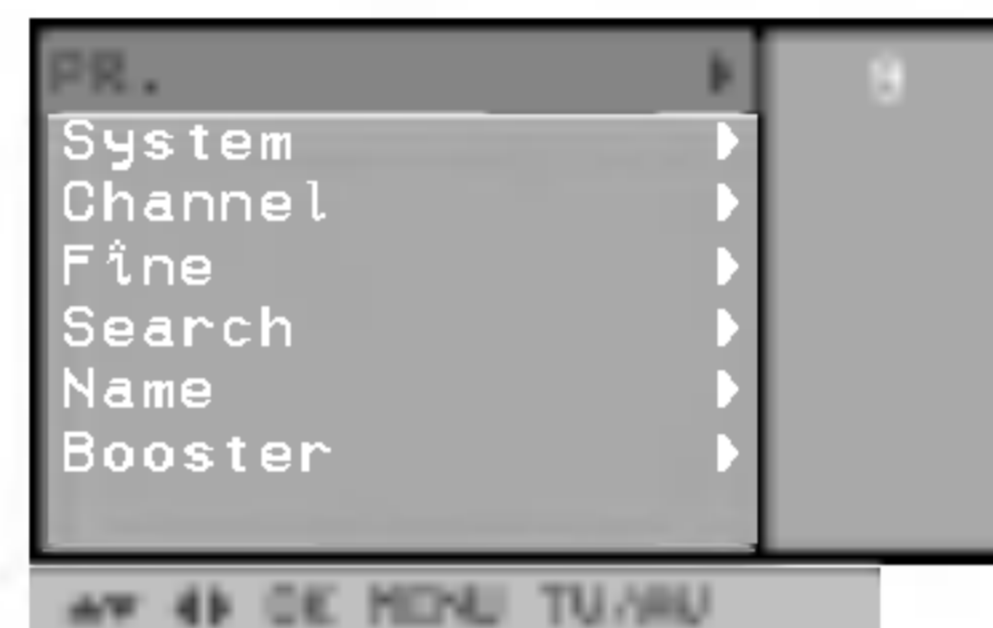
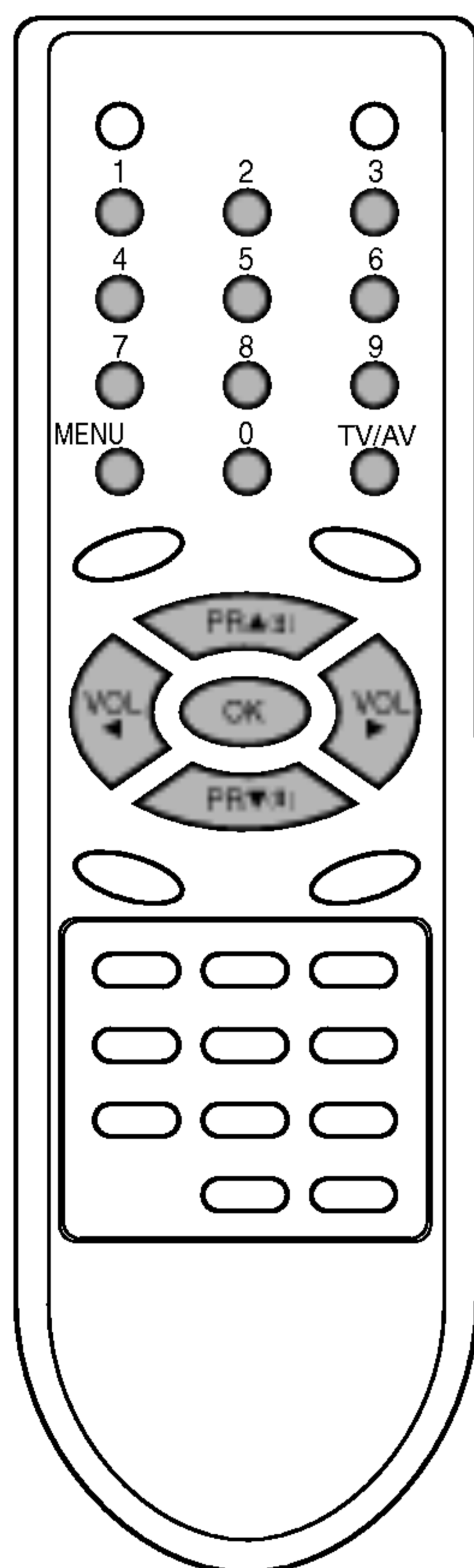

4. Press the ▲ / ▼ button to select **PR.**
5. Press the ► button to select the programme number. Select the desired programme number with the ◀ / ▶ button or NUMBER buttons on the **PR.** pull-down menu. Any number under 10 is entered with a numeric '0' (or '00') in front of it, i.e. '05' (or '005') for 5.
6. Press the **OK** button.
7. Press the ▲ / ▼ button to select **System**.
8. Press the ► button. Select a TV system with the ▲ / ▼ button on the **System** pull-down menu;
 - BG** : (Asia/New Zealand/M.East/Africa/Australia)
 - I** : (Hong Kong/South Africa)
 - DK** : (East Europe/China/Africa/CIS)
 - M** : (USA/Korea/Philippines) (option)
9. Press the **OK** or ◀ button.
10. Press the ▲ / ▼ button to select **Channel**.
11. Press the ► button. Press the ▲ / ▼ button to select **V/UHF** or **Cable** on the **Channel** pull-down menu. If possible, select the channel number directly with the number buttons. Any number under 10 is entered with a numeric '0' (or '00') in front of it, i.e. '05' (or '005') for 5.
12. Press the **OK** or ◀ button.
13. Press the ▲ / ▼ button to select **Search**.
14. Press the ► button. Press the ◀ / ▶ button to commence searching on the **Search** pull-down menu. If a station is found the search will stop.
15. Press the **OK** button to store it. The display **Stored** will appear.

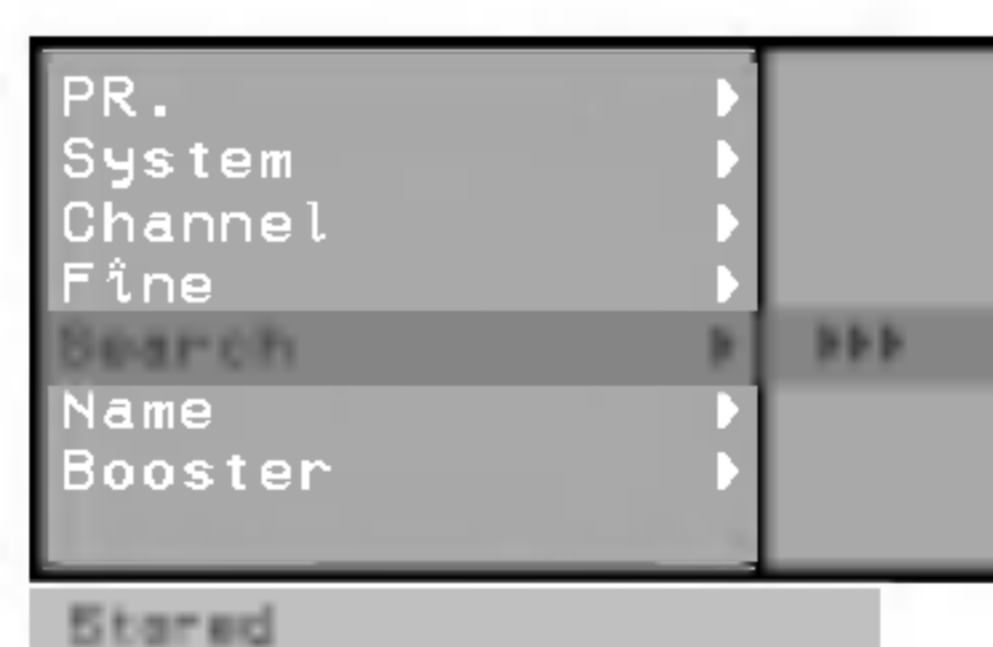

16. To store another station, repeat steps 4 to 15.
17. Press the **TV/AV** button to return to normal TV viewing.

Setting up TV stations

Assigning a station name

1. Repeat the 'Manual programme tuning' steps 1 to 3.
2. Press the ▲ / ▼ button to select **Name**.
3. Press the ► button on the **Name** pull-down menu.
4. Press the ▲ button, You can use a blank, +, -, the numeric **0** to **9** and the alphabet **A** to **Z**.
With the ▼ button you can select in the opposite direction.
5. Select the next position by pressing the ► button and then take your choice of the second character, and so on.
6. Press the **OK** button.
7. Press the **TV/AV** button to return to normal TV viewing.

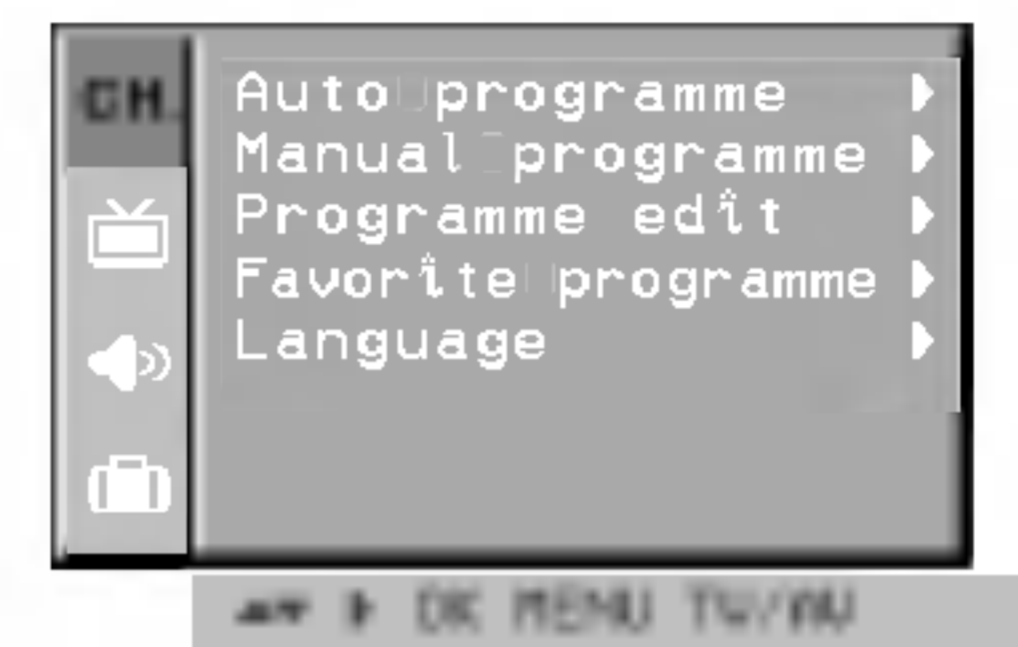

Station Menu

Booster (option)

When the interference between programmes appear, select **Booster** to **Off**.

1. Repeat the 'Manual programme tuning' steps 1 to 3.
2. Press the ▲ / ▼ button to select **Booster**.
3. Press the ► button.
4. Press the ▲ / ▼ button to select **On** or **Off** on the **Booster** pull-down menu.
5. Press the **OK** or ◀ button.
6. Press the **TV/AV** button to return to normal TV viewing.

Fine tuning

Normally fine tuning is only necessary if reception is poor.

1. Repeat the 'Manual programme tuning' steps 1 to 3.
2. Press the ▲ / ▼ button to select **Fine**.
3. Press the ► button.
4. Press the ◀ / ► button to fine tune for the best picture and sound on the **Fine** pull-down menu.

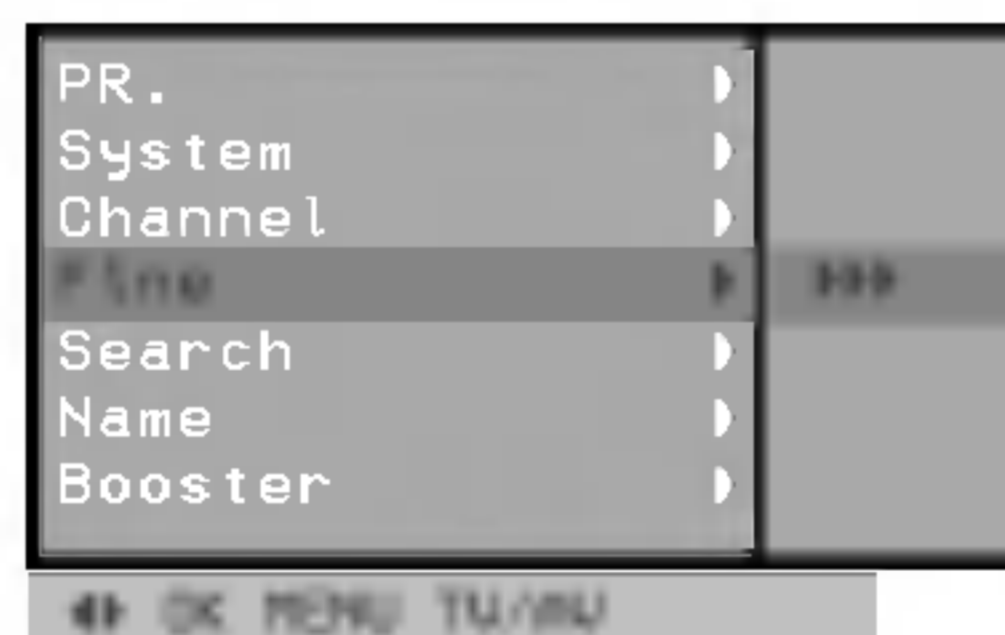

5. Press the **OK** button.
6. Press the **TV/AV** button to return to normal TV viewing.
The finely tuned programme will be indicated by a gray number during programme selection.

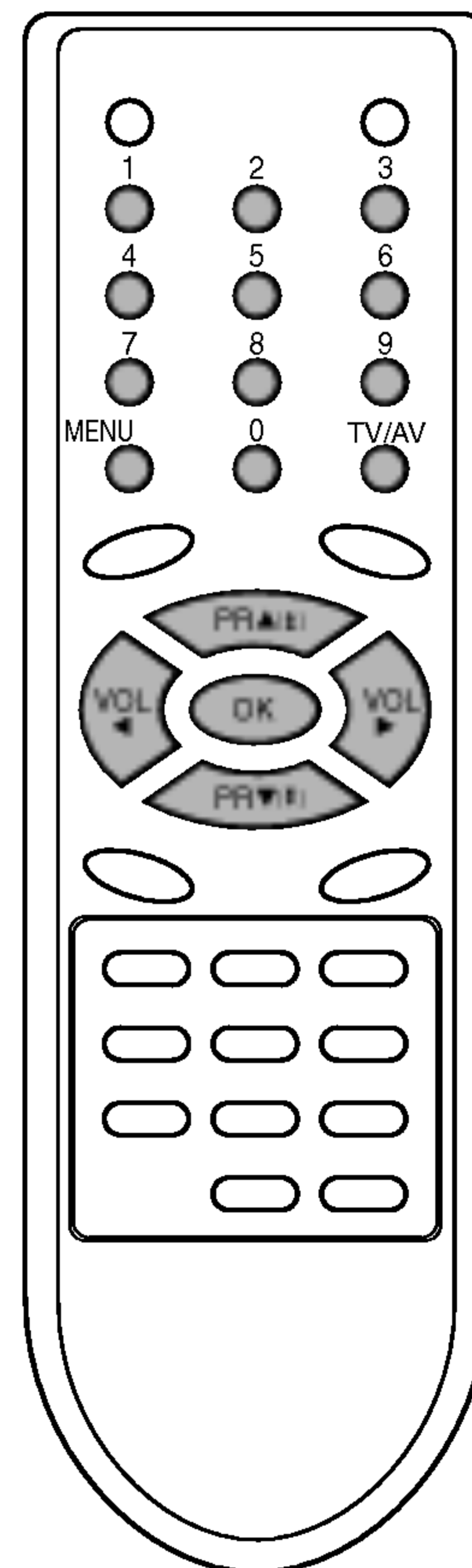

Setting up TV stations



Programme edit

This function enables you to delete or skip the stored programmes. Also you can move some stations to other programme numbers or insert a blank station data into the selected programme number.

1. Repeatedly press the **MENU** button to select the Station menu.
2. Press the **▶** button and then **▲ / ▼** button to select **Programme edit**.
3. Press the **▶** button to display the **Programme edit** menu.

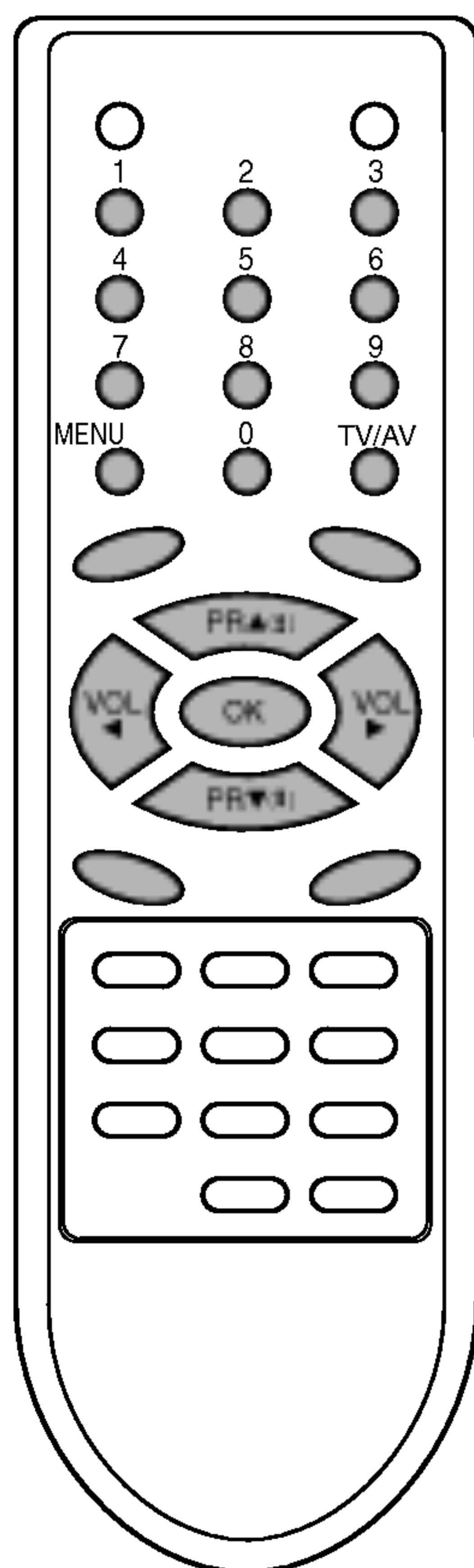

Deleting a programme

1. Select a programme to be deleted with the **▲ / ▼** or **◀ / ▶** button.
2. Press the **RED** button twice.
The selected programme is deleted, all the following programmes are shifted up one position.

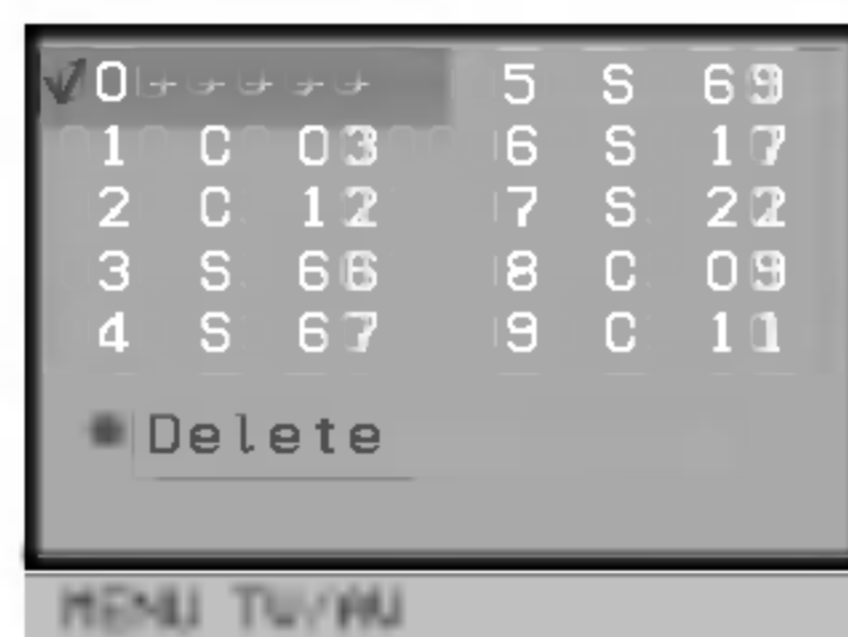

Copying a programme

1. Select a programme to be copied with the **▲ / ▼** or **◀ / ▶** button.
2. Press the **GREEN** button.
All the following programmes are shifted down one position.

Moving a programme

1. Select a programme to be moved with the **▲ / ▼** or **◀ / ▶** button.
2. Press the **YELLOW** button.
3. Move the programme to the desired programme number with the **▲ / ▼** or **◀ / ▶** button.
4. Press the **YELLOW** button again to release this function.

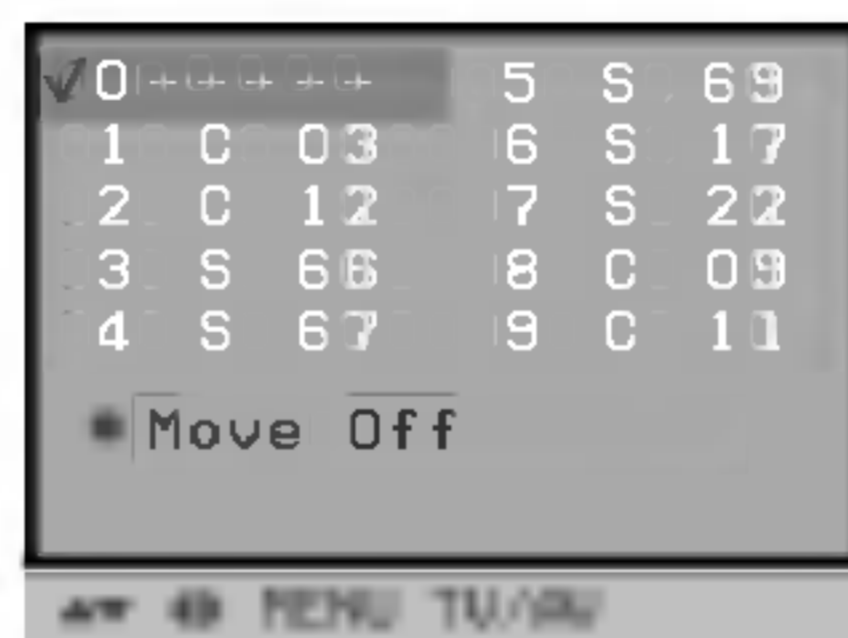

Skipping a programme number

1. Select a programme number to be skipped with the **▲ / ▼** or **◀ / ▶** button.
2. Press the **BLUE** button. The skipped programme turns to blue.
3. Press the **BLUE** button again to release the skipped programme.

When a programme number is skipped it means that you will be unable to select it using the **▲ / ▼** button during normal TV viewing. If you want to select the skipped programme, directly enter the programme number with the **NUMBER** buttons or select it in the programme edit or table menu.

Press the **TV/AV** button to return to normal TV viewing.

Setting up TV stations

Favorite programme

This function lets you select your favorite programmes directly.

1. Repeatedly press the **MENU** button to select the Station menu.
2. Press the **▶** button and then **▲ / ▼** button to select **Favorite programme**.
3. Press the **▶** button to display the **Favorite programme** menu.

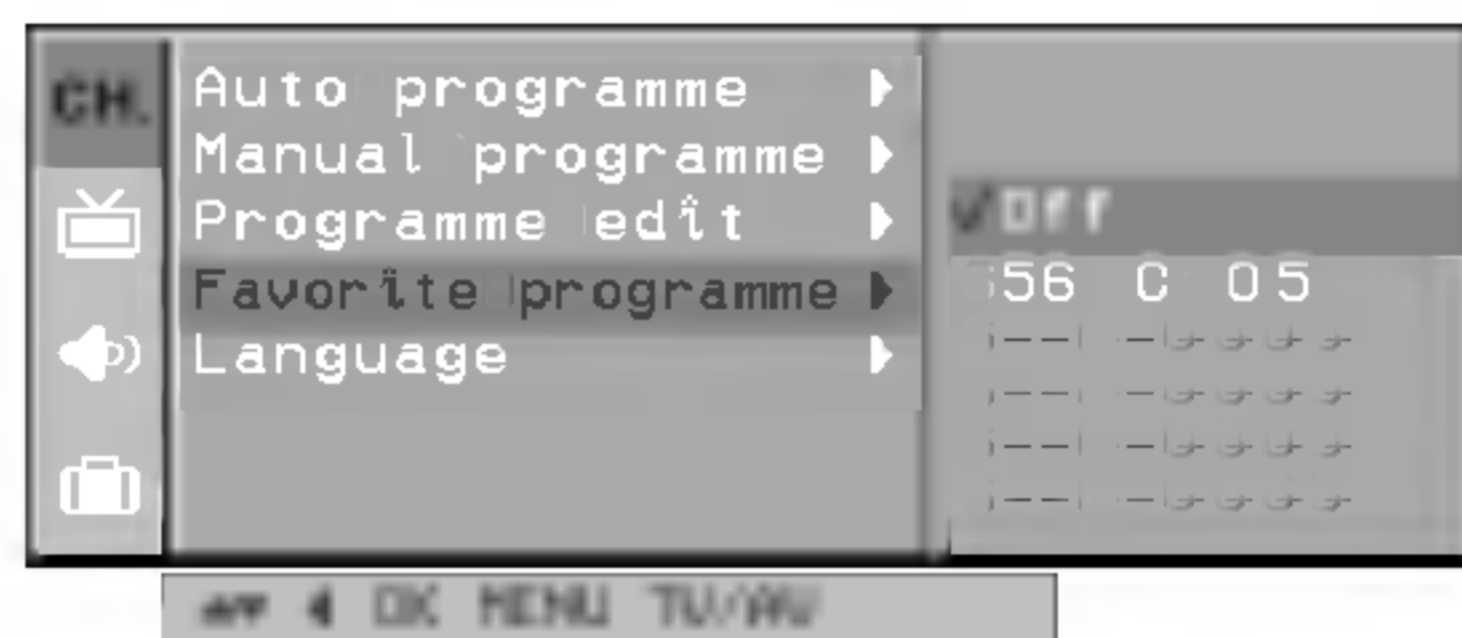

4. Press the **▲ / ▼** button to select -- ----.
5. Select a desired programme with the **◀ / ▶** button or **NUMBER** buttons. Any number under 10 is entered with a numeric '0' in front of it, i.e. '05' for 5.
6. To store another programme, repeat steps 4 to 5. You can store up to 5 programmes.
7. Press the **OK** button.
8. Press the **TV/AV** button to return to normal TV viewing.

Repeatedly press the **Q.VIEW** button to select stored favorite programmes.

Calling the programme table

You can check the programmes stored in the memory by displaying the programme table.

Displaying programme table

Press the **LIST** button to display the **Programme table** menu. The programme table appears on the screen. One programme table contains ten programmes as below.

√ 0	----	5	S	69
1	0 03	6	S	17
2	0 12	7	S	22
3	S 6B	8	C	09
4	S 67	9	C	11

Note :

- a. You may find some blue programmes. They have been set up to be skipped by auto programming or in the programme edit mode.
- b. Some programmes with the channel number shown in the programme table indicate there is no station name assigned.

Selecting a programme in the programme table

Select a programme with the **▲ / ▼** or **◀ / ▶** button. Then press the **OK** button. The set switches to the chosen programme number.

Paging through a programme table

There are 10 (or 20) programme table pages in which contain 100 (or 200) programmes. Pressing the **▲ / ▼** or **◀ / ▶** button repeatedly turns the pages.

Press the **TV/AV** button to return to normal TV viewing.

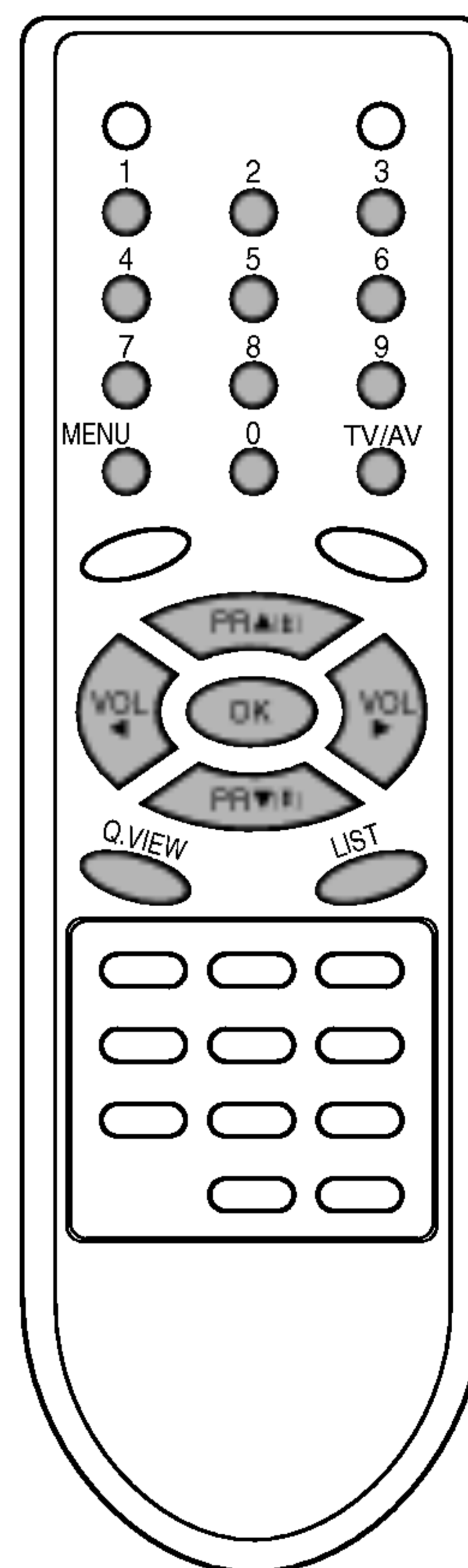

Picture adjustment



PSM (Picture Status Memory)

1. Repeatedly press the **MENU** button to select the Picture menu.
2. Press the **▶** button to select **PSM**.
3. Press the **▶** button and then **▲ / ▼** button to select a picture setting on the **PSM** pull-down menu.

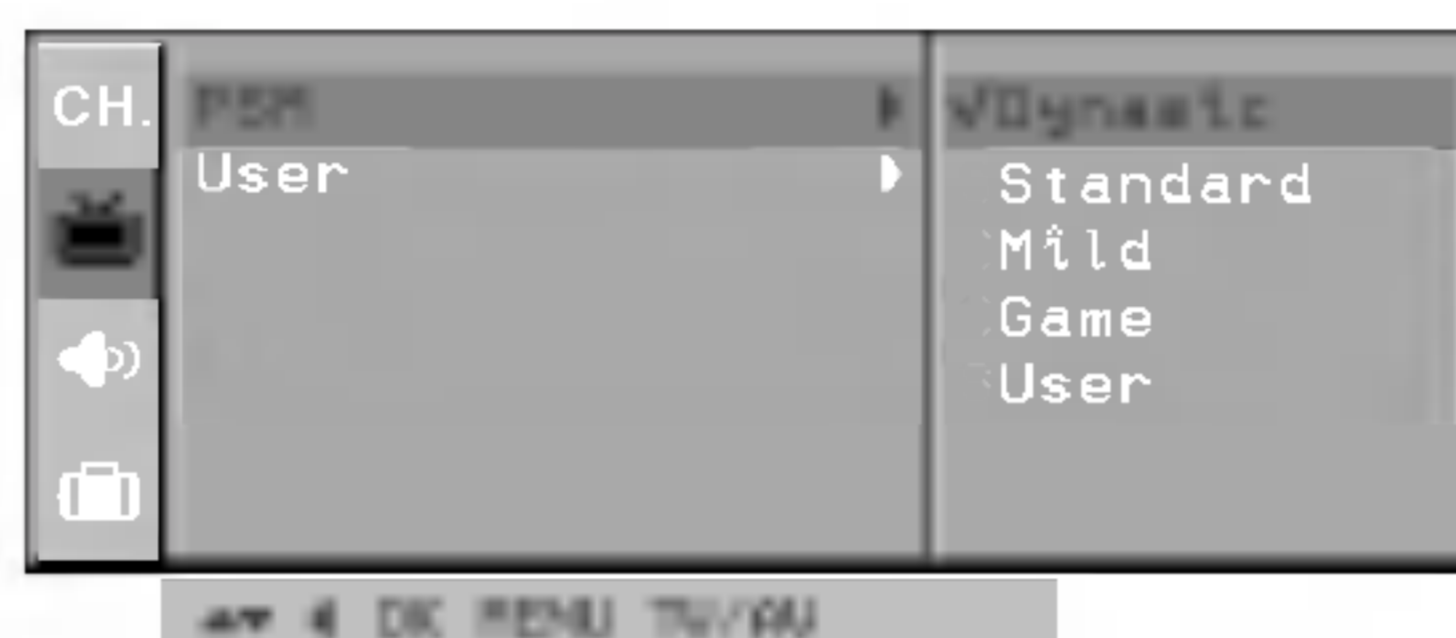

4. Press the **OK** or **◀** button.
5. Press the **TV/AV** button to return to normal TV viewing.

You can also recall a desired picture (**Dynamic**, **Standard**, **Mild**, **Game** or **User**) with **PSM** button on the remote control. The picture **Dynamic**, **Standard**, **Mild** and **Game** are programmed for good picture reproduction at the factory and cannot be changed.

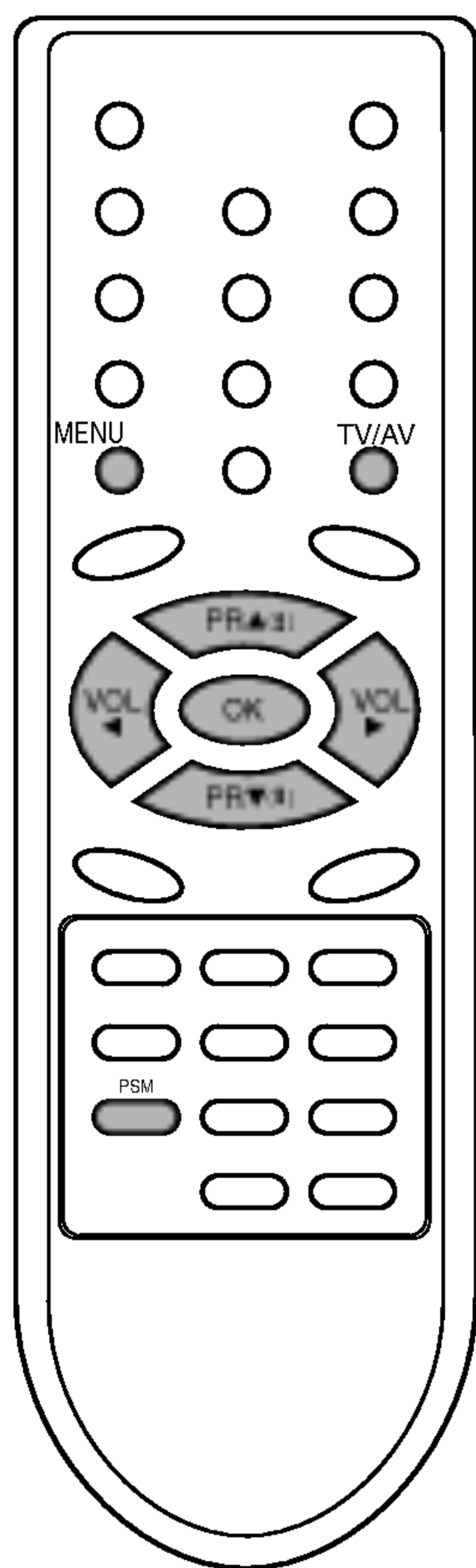

Picture adjustment

You can adjust picture contrast, brightness, colour intensity, sharpness and tint (NTSC input only) to the levels you prefer.

1. Repeatedly press the **MENU** button to select the Picture menu.
2. Press the **▶** button and then **▲ / ▼** button to select **User**.
3. Press the **▶** button and then **▲ / ▼** button to select the desired picture item on the **User** pull-down menu.

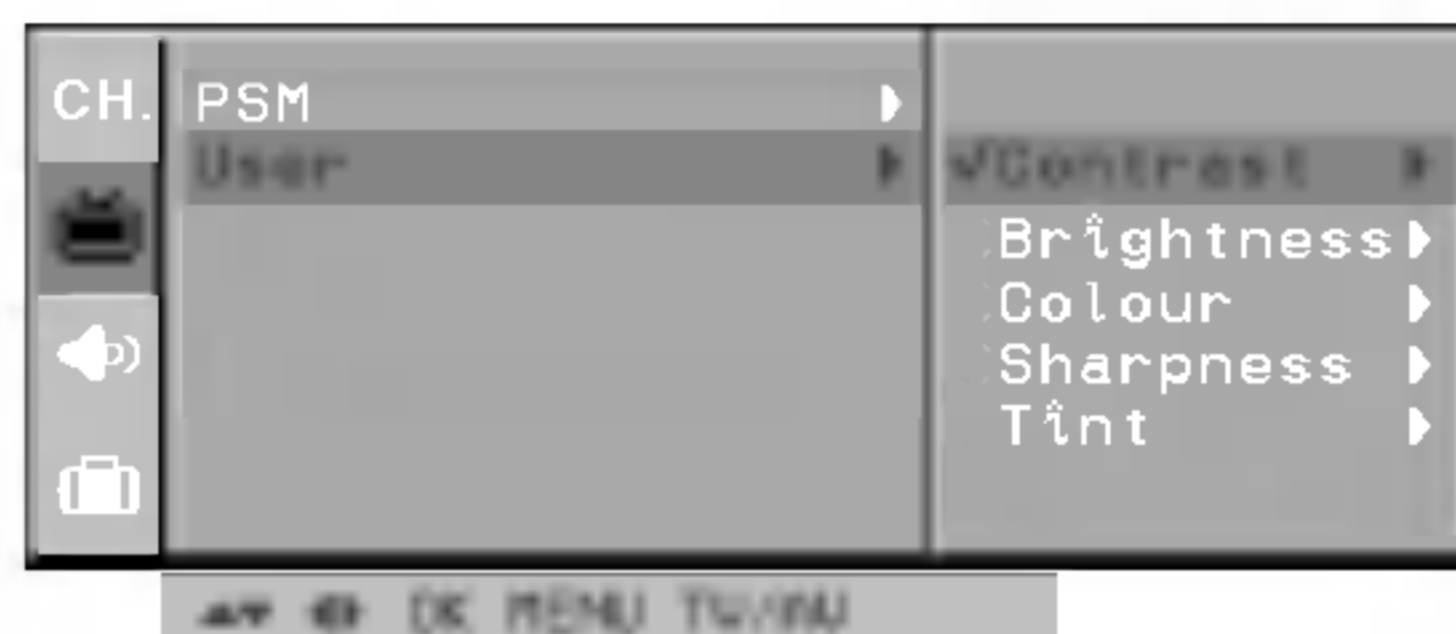

4. Press the **▶** button.
5. Press the **◀ / ▶** button to make appropriate adjustments on the each sub menu.



- You can also select other **User** items directly with **▲ / ▼** button and adjust them with **◀ / ▶** button.
6. Press the **OK** button to store it for the picture **User**.
 7. Press the **TV/AV** button to return to normal TV viewing.

Picture adjustment

Eye (option)

On some models, the set will automatically adjust the picture according to the surrounding conditions. This will enable you to enjoy the most suitable picture according to the surroundings.

Press the **EYE/★** button to switch the eye function on or off.

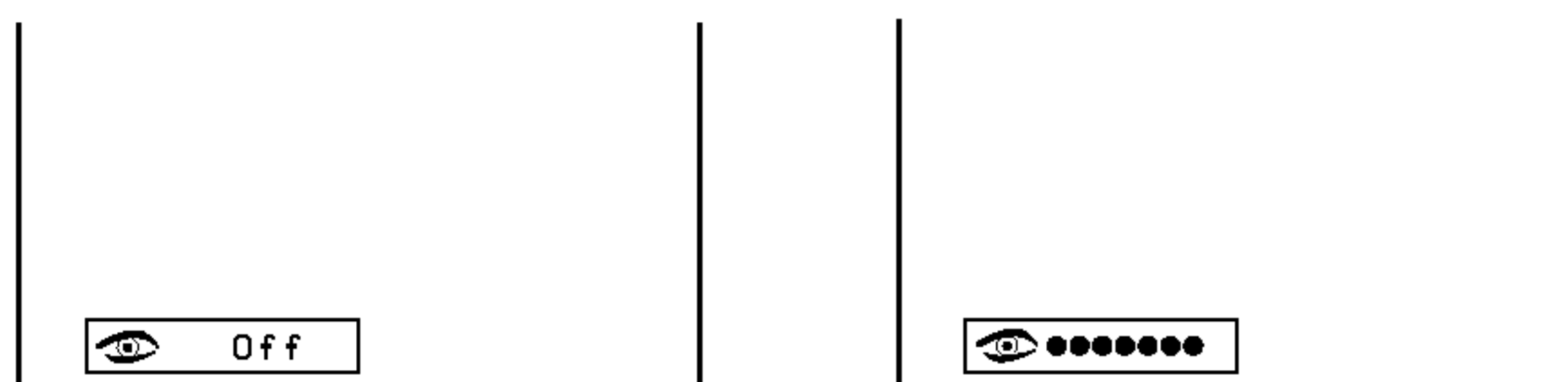

When the eye function is on, the most suitable picture is automatically adjusted according to the surrounding conditions. At this time the display ●●●●●● in green does not appear continuously but the display ●●●●●● in yellow appears each time the picture condition changes.

Note : If you press the **PSM** or **TURBO PICTURE** button with the eye function, the eye function is automatically switched off.

Turbo picture selection (option)

When this function is on, the picture will be more brilliant and distinct picture than normal picture. You can enjoy the Turbo picture so much better than normal picture.

Repeatedly press the **TURBO PICTURE** button to switch on or off.

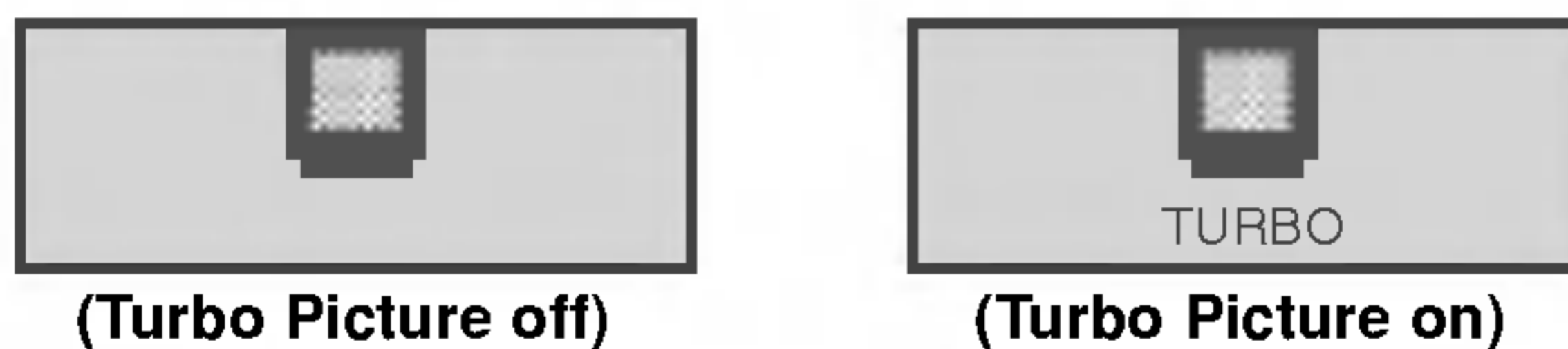

Note : If you press the **PSM** or **EYE/★** button with the Turbo picture function, the Turbo picture function is automatically switched off.

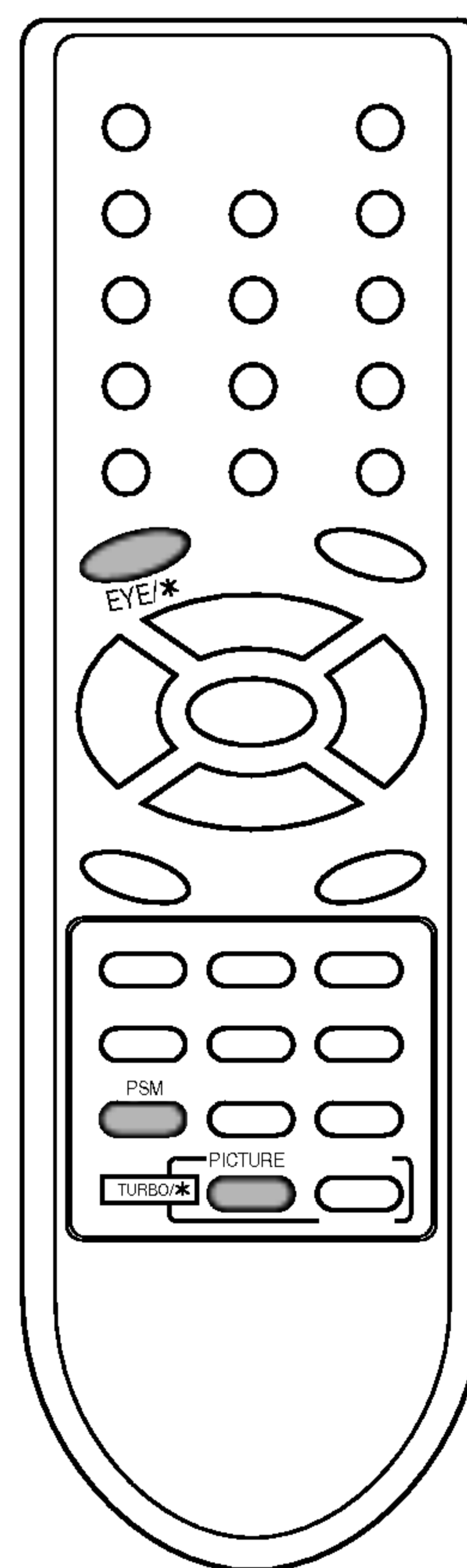

Sound adjustment (option)



Sound adjustment is an optional function only a set with sound adjustment can perform this function.

SSM (Sound Status Memory)

You can select your preferred sound setting; Flat, Music, Movie or Speech and you can also adjust the sound frequency of the equalizer. The surround sound creates an all around sound as in a concert hall.

1. Repeatedly press the **MENU** button to select the Sound menu.
2. Press the **▶** button to select **SSM**.
3. Press the **▶** button and then **▲ / ▼** button to select a sound setting on the **SSM** pull-down menu.

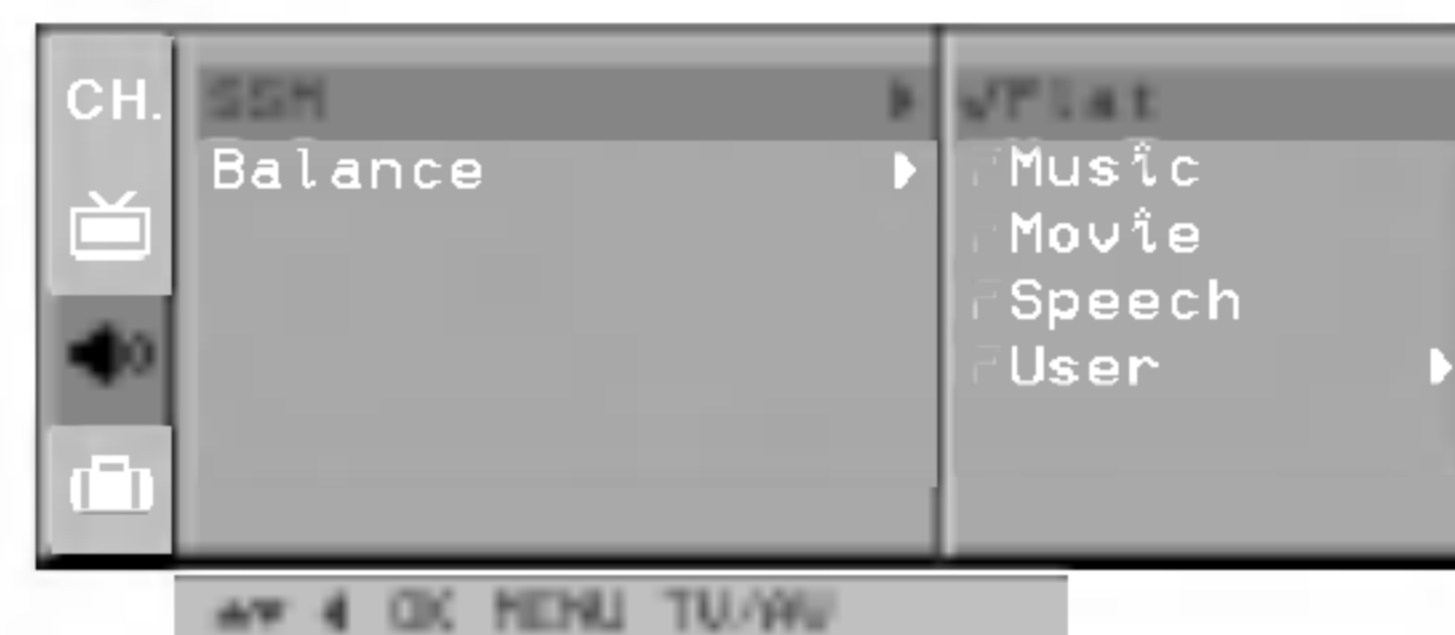

Sound Frequency Adjustment

- a. Press the **▶** button in **User** to display the **User** sub menu.



- b. Select a sound band by pressing the **◀ / ▶** button.
- c. Make appropriate sound level with the **▲ / ▼** button.
- d. Press the **OK** button to store it for the sound **User**.
The display **Stored** appears.

Press the **TV/AV** button to return to normal TV viewing.

You can also recall a desired sound (**Flat**, **Music**, **Movie**, **Speech** or **User**) with **SSM/★** button on the remote control. The sound **Flat**, **Music**, **Movie** and **Speech** are programmed for optimum sound reproduction at the factory and cannot be changed.

Note : If you press the **SSM/★** button after making appropriate adjustment on the **User** sub menu, the display **User** automatically appears even though you have already set a factory preset setting; **Flat**, **Music**, **Movie** or **Speech**.

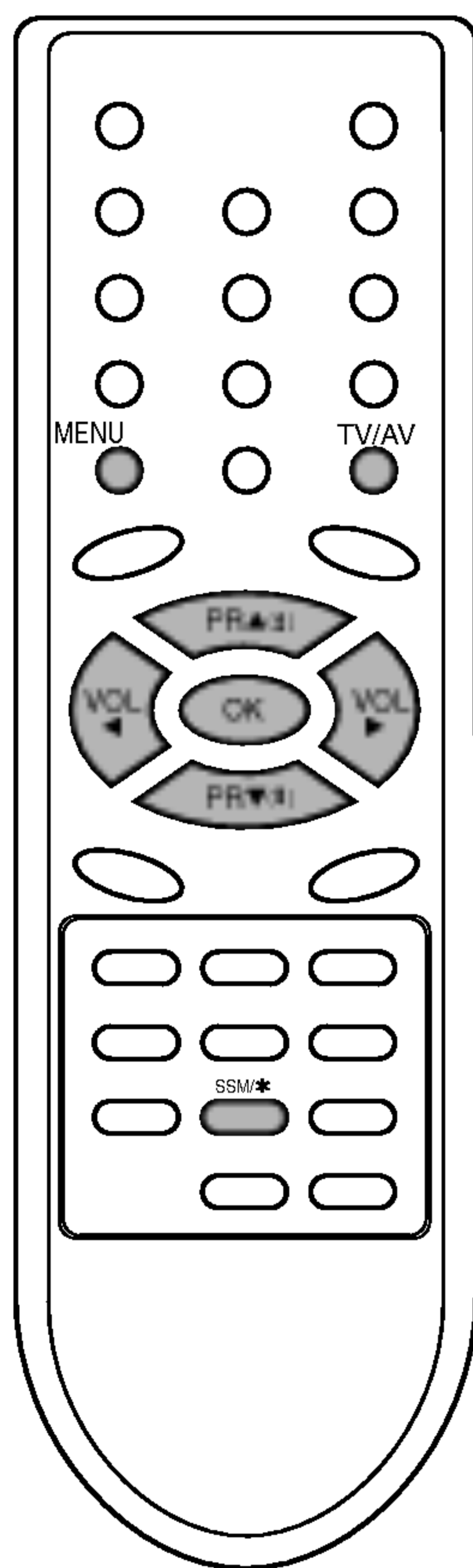

Sound adjustment (option)

Balance adjustment

You can adjust balance.

1. Repeatedly press the **MENU** button to select the Sound menu.
2. Press the **▶** button and then **▲ / ▼** button to select **Balance**.
3. Make desired adjustment with the **◀ / ▶** button on the **Balance** pull-down menu.



Sound Menu

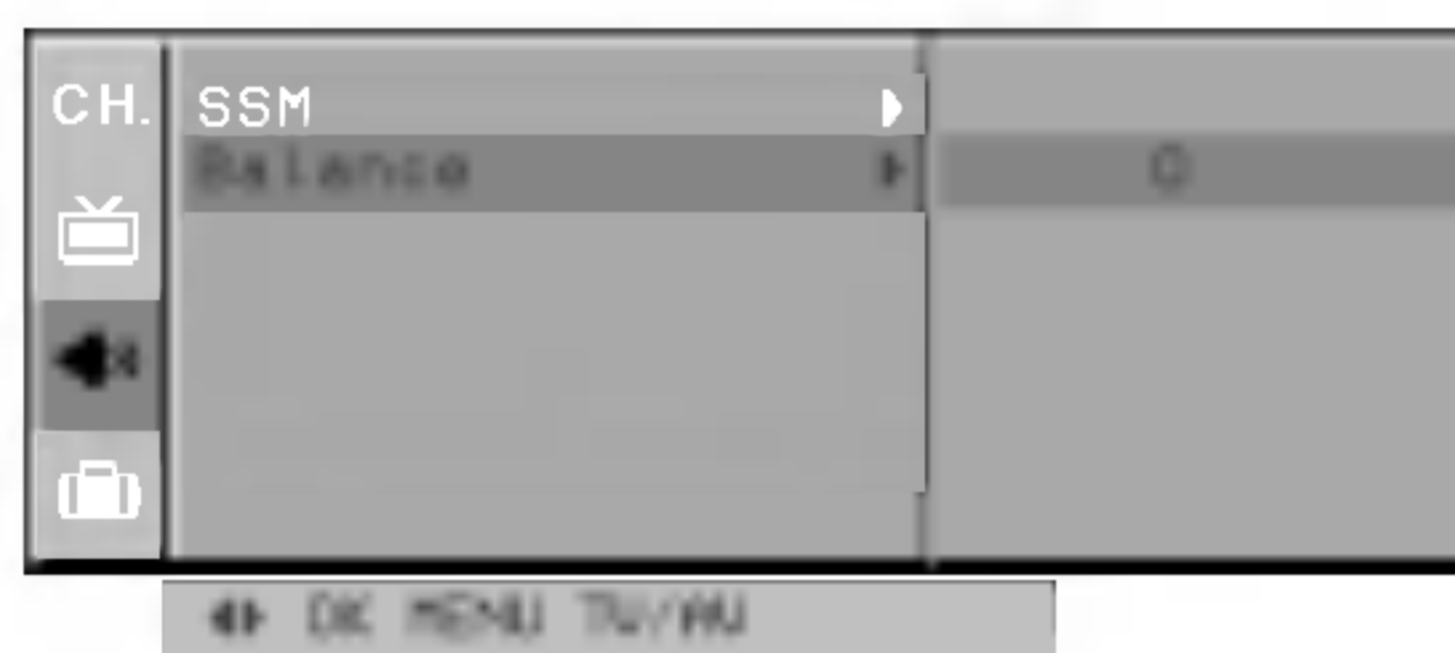

4. Press the **OK** button.
5. Press the **TV/AV** button to return to normal TV viewing.

Turbo sound selection (option)

When this function is on, the sound will be more emphasized and amplified sound than normal sound. You can enjoy the Turbo Sound so much better than normal Sound.

Repeatedly press the **TURBO SOUND** button to switch on or off.



(Turbo Sound off)



(Turbo Sound on)

Sound output selection

In AV mode, you can select output sound for the left and right loud-speakers.

Repeatedly press the **I/II/★** button to select the sound output.

L+R : Audio signal from audio L input is sent to left loud-speaker and audio signal from audio R input is sent to right loud-speaker.

L+L : Audio signal from audio L input is sent to left and right loud-speakers.

R+R : Audio signal from audio R input is sent to left and right loud-speakers.

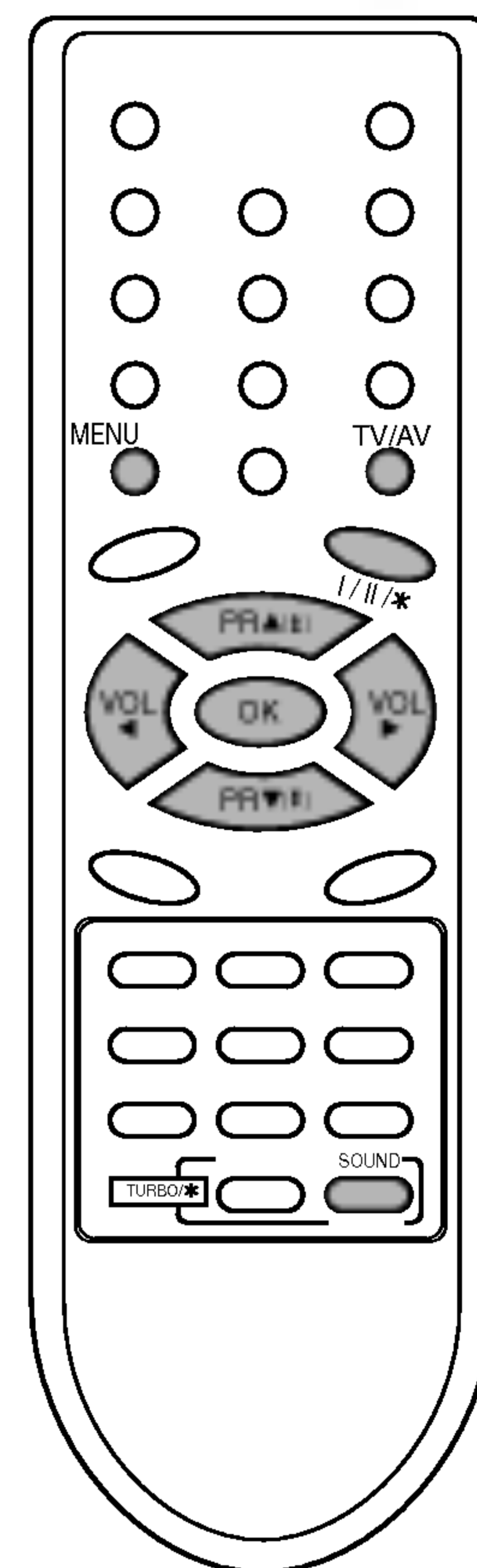

Sound adjustment (option)

Stereo/Dual reception (option)

When a programme is selected, the sound information for the station appears after the programme number and station name disappear.

Broadcast	On Screen Display
Mono	MONO
Stereo	STEREO
Dual	DUAL I

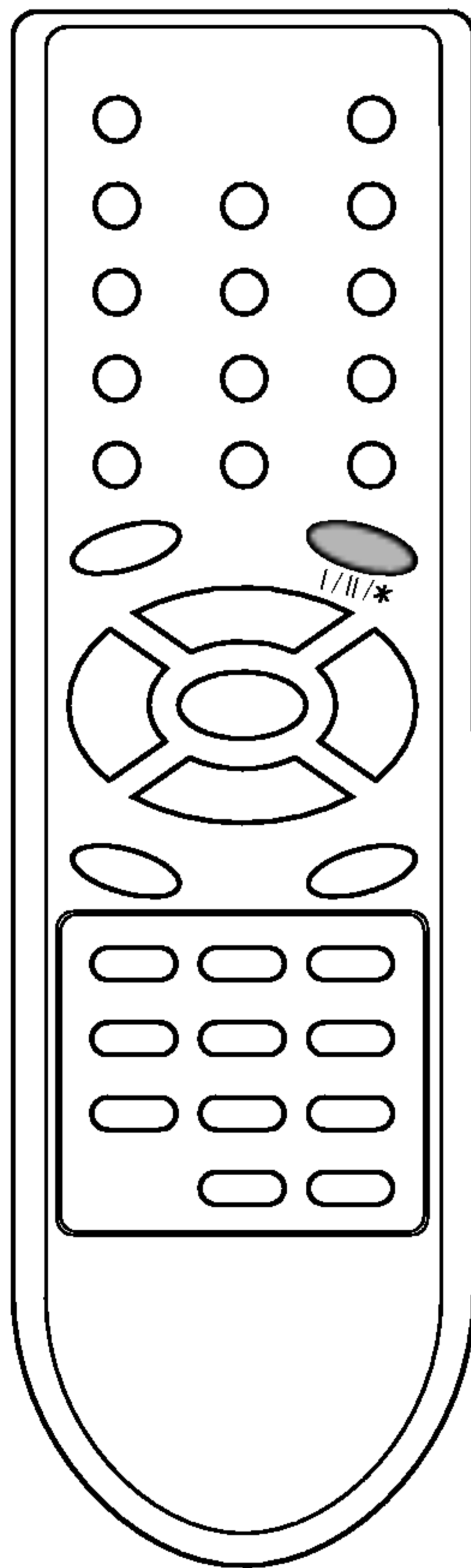

Mono sound selection

In stereo reception if the stereo signal is weak, you can switch to mono by pressing the **I/II/*** button twice. In mono reception the depth of sound is improved. To switch back to stereo, press the **I/II/*** button twice again.

Language selection for dual language broadcast

If a programme received in two languages (dual language), you can switch to **DUAL I**, **DUAL II** or **DUAL I+II** by pressing the **I/II/*** button repeatedly.

DUAL I sends the primary broadcast language to the loudspeakers.

DUAL II sends the secondary broadcast language to the loudspeakers.

DUAL I+II sends a separate language to each loudspeaker.

NICAM reception (option)

If your set is equipped with the receiver for NICAM reception, the high quality NICAM (Near Instantaneous Companding Audio Multiplex) digital sound can be received.

Sound output can be selected according to the type of received broadcast as follows by pressing the **I/II/*** button repeatedly.

1. When NICAM mono is received, you can select **NICAM MONO** or FM MONO.
2. When NICAM stereo is received, you can select **NICAM STEREO** or FM MONO. If the stereo signal is weak, switch to FM mono.
3. When NICAM dual is received, you can select **NICAM DUAL I**, **NICAM DUAL II** or **NICAM DUAL I+II** or **MONO**. When FM mono is selected the display **MONO** appears on the screen.

Other functions

TV and AV modes

Inputs can be set for TV or AV mode. AV mode is used when a video cassette recorder (VCR), or other equipment is connected to the set.

Note : When a VCR is connected via the aerial socket the set is used in TV mode. See the 'Connection of external equipment' section.

1. Repeatedly press the **MENU** button to select the Special menu.
2. Press the **▶** button to select **Input**.
3. Press the **▶** button and then **▲ / ▼** button to select **TV** or **AV** on the **Input** pull-down menu.

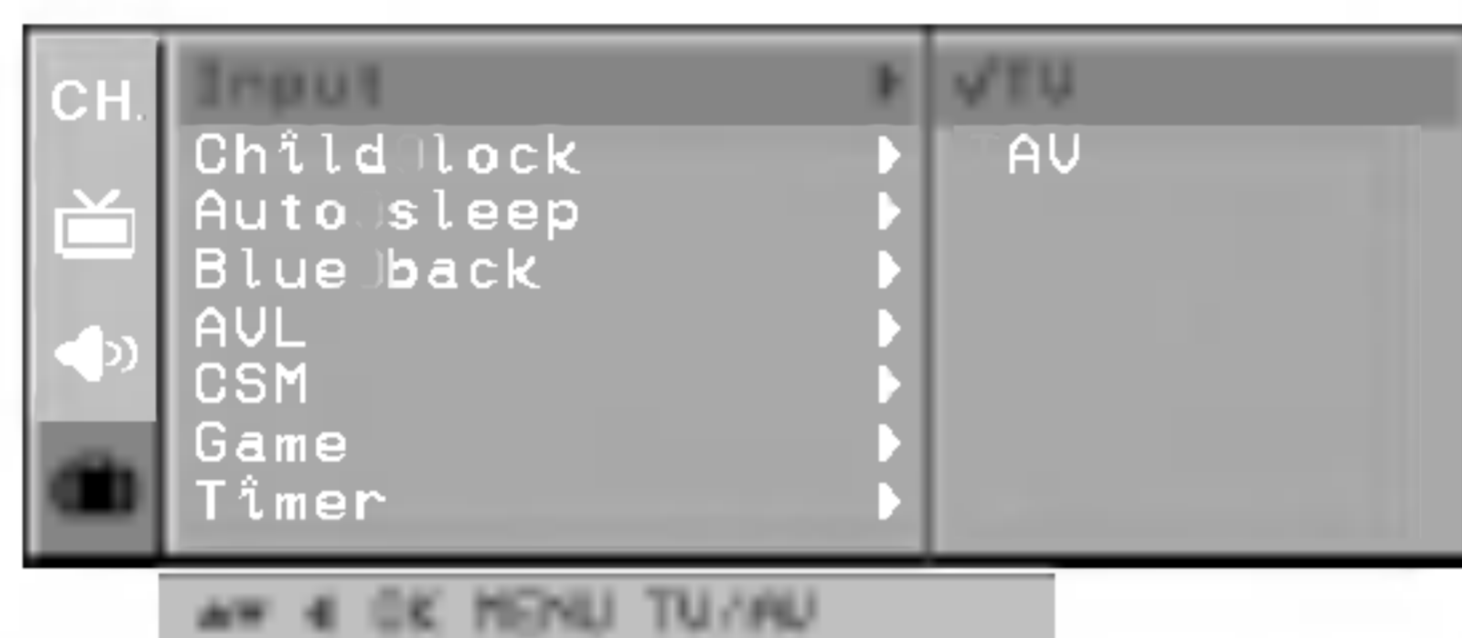

Special Menu

- AV : VCR connected to the Euro scart socket or **AV** sockets on the set
4. Press the **TV/AV** button to return to normal TV viewing.

Note : If both the input jacks on the front/side panel and back panel have been connected to external equipments simultaneously, only the input jacks on the front/side panel can be received.

Alternatively you can select the TV or AV mode by pressing the **TV/AV** button.

In AV mode, to return to TV mode, press the **▲ / ▼** or **NUMBER** buttons.

Auto AV switching (option)

If your VCR outputs a switching voltage when connected to the Euro scart socket, the set will switch to AV mode automatically. The set is automatically switched to **AV** mode when an AV signal is input. But if you want to keep on watching TV mode, press the **▲ / ▼** or **NUMBER** buttons.

Press the **TV/AV** button to return to AV modes.

Child lock

The TV can be set so that the remote control handset is needed to control it. This feature can be used to prevent unauthorized viewing.

1. Repeatedly press the **MENU** button to select the Special menu.
2. Press the **▶** button and then **▲ / ▼** button to select **Child lock**.
3. Press the **▶** button and then **▲ / ▼** button to select **On** or **Off** on the **Child lock** pull-down menu.
4. Press the **TV/AV** button to return to normal TV viewing.

With the lock on, the display **Child lock on** appears on the screen if any button on the front panel is pressed while viewing the TV.

Note : The display **Child lock on** will not appear on the screen if any button on the front panel is pressed while displaying the menus.

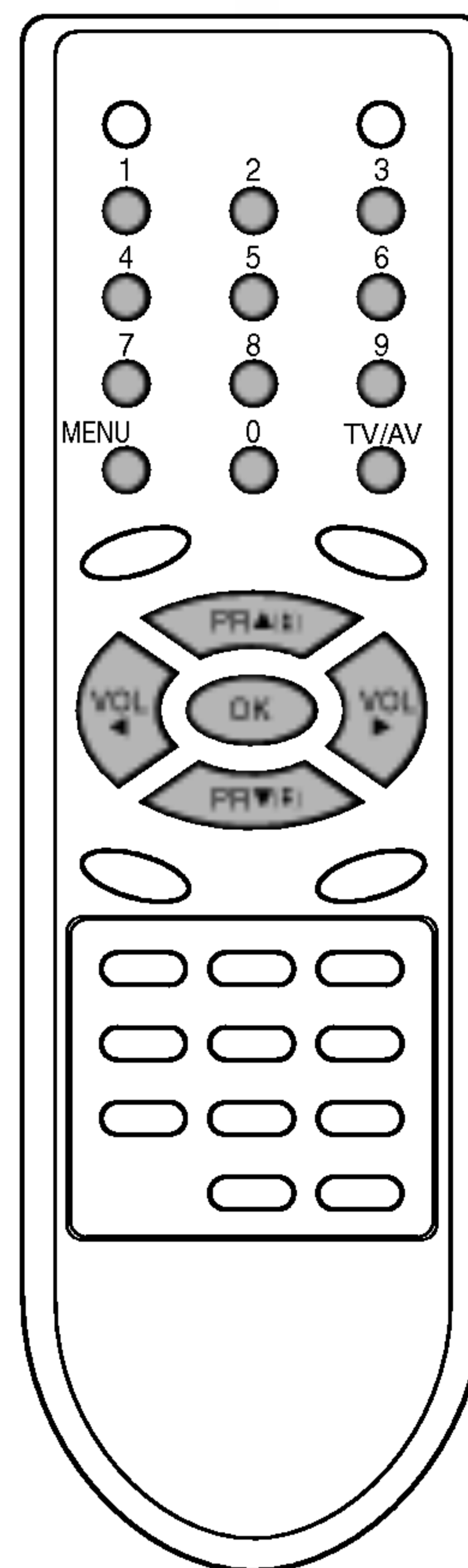

Other functions



Auto sleep

If you select **On** on the **Auto sleep** pull-down menu, the set will automatically switch itself to standby mode approximately ten minutes after a TV station stops broadcasting.

1. Repeatedly press the **MENU** button to select the Special menu.
2. Press the **▶** button and then **▲ / ▼** button to select **Auto sleep**.
3. Press the **▶** button and then **▲ / ▼** button to select **On** or **Off** on the **Auto sleep** pull-down menu.
4. Press the **TV/AV** button to return to normal TV viewing.

Blue back (option)

If you select **On** on the **Blue back** pull-down menu, the blue background appears on the screen when there is no or poor signal.

1. Repeatedly press the **MENU** button to select the Special menu.
2. Press the **▶** button and then **▲ / ▼** button to select **Blue back**.
3. Press the **▶** button and then **▲ / ▼** button to select **On** or **Off** on the **Blue back** pull-down menu.
4. Press the **TV/AV** button to return to normal TV viewing.

AVL (Auto Volume Leveler) (option)

If you select **AVL On**, the set automatically keeps on an equal volume level even if you change programmes.

1. Repeatedly press the **MENU** button to select the Special menu.
2. Press the **▶** button and then **▲ / ▼** button to select **AVL**.
3. Press the **▶** button and then **▲ / ▼** button to select **On** or **Off** on the **AVL** pull-down menu.
4. Press the **TV/AV** button to return to normal TV viewing.

CSM (Colour Status Memory)

You can select the picture colour status; standard, reddish, greenish or bluish, as you prefer.

1. Repeatedly press the **MENU** button to select the Special menu.
2. Press the **▶** button and then **▲ / ▼** button to select **CSM**.
3. Press the **▶** button and then **▲ / ▼** button to select **Standard**, **Reddish**, **Greenish** or **Bluish** on the **CSM** pull-down menu.
4. Press the **TV/AV** button to return to normal TV viewing.

Sleep timer

You don't have to remember to switch the set off before you go to sleep. The sleep timer automatically switches the set to standby after the preset time elapses.

Press the **SLEEP** button to select the number of minutes. The display **⏰ ---** will appear on the screen, followed by **00:10**, **00:20**, **00:30**, **01:00**, **01:30**, **02:00**, **03:00** and **04:00**. The timer begins to count down from the number of minutes selected.

Note :

- a. To view the remaining sleep time, press the **SLEEP** button once.
- b. To cancel the sleep time, repeatedly press the **SLEEP** button until the display **⏰ ---** appears.
- c. When you switch the set off, the set releases the preset sleep time.

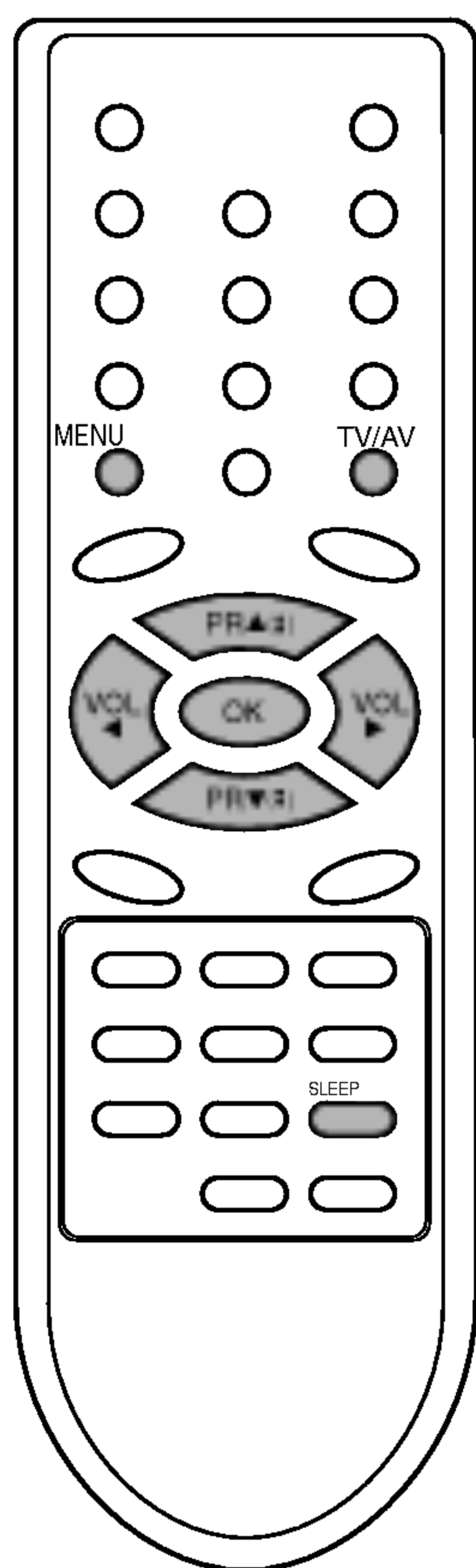

Game (option)

Game is an optional function, only a set with game can perform this function by using the remote control handset. You can enjoy only two of four games below with this set.

Block & Balloon (option)

1. Repeatedly press the **MENU** button to select the Special menu.
2. Press the **▶** button and then **▲ / ▼** button to select **Game**.
3. Press the **▶** button to enter the game mode.
4. Press the **◀ / ▶** button to select the game 1 or 2 and then press the **OK** button.
5. Press the **◀ / ▶** button to select a level and then press the **OK** button.

1. Block

6. Press the **▲ / ▼** button to select a block to shoot or to dump. Press the **◀** button to shoot the block aiming at the same colour or press the **▶** button to dump it. Remove all the blocks on the screen with given blocks, whose remaining number is displayed on the right bottom of the screen. If you use up all the given blocks or the dumped blocks are accumulated to the end, you lose. Press the **OK** button to start.

2. Balloon

6. Press the **▲ / ▼** button to move the arrow. Press the **◀** button to shoot an arrow aiming balloon only. The numbers of balloons you should hit and have hit are displayed on the right bottom of the screen. If you miss a balloon, it will be accumulated and you lose the space to move the arrow. If the missed balloons or the hit bricks are accumulated at the end, you lose. Press the **OK** button to start.

Cricket & Car racing (option)

1. Repeatedly press the **MENU** button to select the Special menu.
2. Press the **▶** button and then **▲ / ▼** button to select **Game**.
3. Press the **▶** button to enter the game mode.
4. Press the **◀ / ▶** button to select the game 1 or 2 and then press the **OK** button.

1. Cricket

5. Press the **▲ / ▼** button to select a number of overs to play, then press the **OK** button.
6. Press the **▲ / ▼** button to select a your team, then press the **OK** button.
7. Press the **▲ / ▼** button to select a computer team, then press the **OK** button.
8. Press the **▲ / ▼** button to select a uniform colour of your team, then press the **OK** button.
9. Press the **◀ / ▶** button to select **HEADS** or **TAILS**, then press the **OK** button.
10. Press the **▲ / ▼** button to select **BATTING** or **FIELDING**, then press the **OK** button.
11. Press the **▲ / ▼** button to select a bowler type, then press the **OK** button to start the game.
For fielding, first select a ball type with the **◀ / ▶** button and then press the **OK** button. Secondly select a bowl direction with the **◀ / ▶ / ▲ / ▼** button and then press the **OK** button to throw the ball. For batting, select a hitter position with the **◀ / ▶ / ▲ / ▼** button and then press the **OK** button to hit the ball. After hitting the ball, control the hitter with the **▲ / ▼** button.

2. Car racing

5. Press the **▲ / ▼** button to select a round, then press the **OK** button to start the game.
Control the car with the **◀ / ▶ / ▲ / ▼** button.

Note :

- a. Press the **TV/AV** or **MENU** button to return to the normal TV viewing.
- b. If you want a new game, press the **RED** button to start during the game.



Special Menu

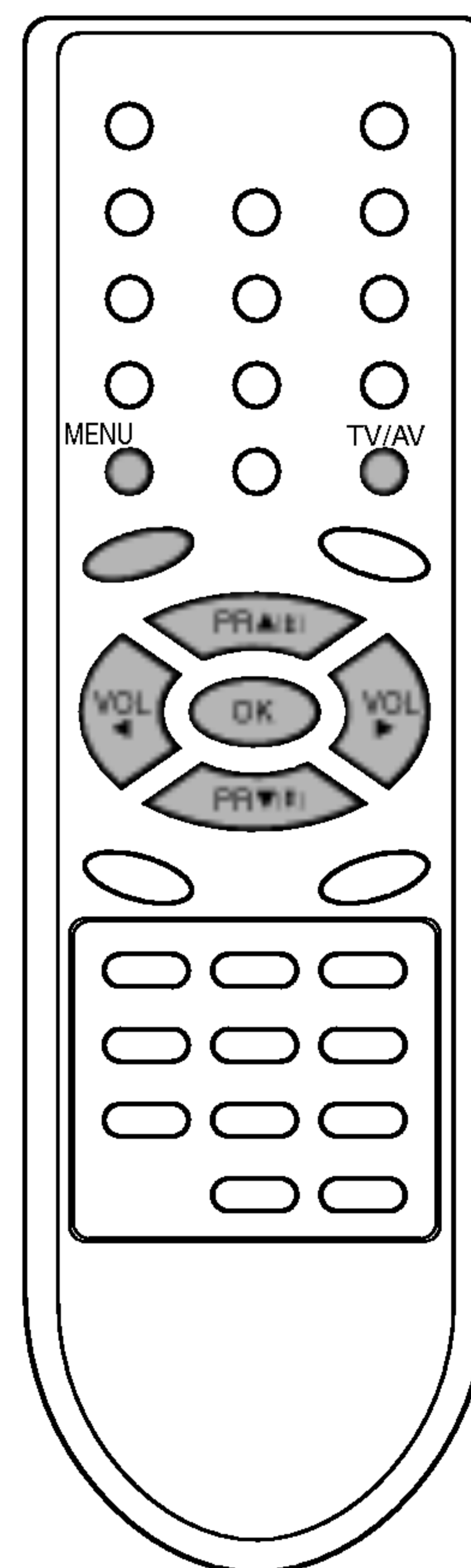

Timer (option)



Timer adjustment is an optional function only a set with timer adjustment can perform this function.

Off timer

The off timer automatically switches the set to standby after the pre-set time elapses.

1. Repeatedly press the **MENU** button to select the Special menu.
2. Press the **▶** button and then **▲ / ▼** button to select **Timer**.
3. Press the **▶** button and then **▲ / ▼** button to select **Off timer**.



4. Press the **▶** button.
5. Select and adjust hour and minute by pressing the **◀ / ▶** button.
6. Press the **OK** button.
7. Press the **TV/AV** button to return to normal TV viewing.

On timer

The on timer automatically switches on after the preset time elapses with desired programme number and volume.

1. Repeatedly press the **MENU** button to select the Special menu.
2. Press the **▶** button and then **▲ / ▼** button to select **Timer**.
3. Press the **▶** button and then **▲ / ▼** button to select **On timer**.

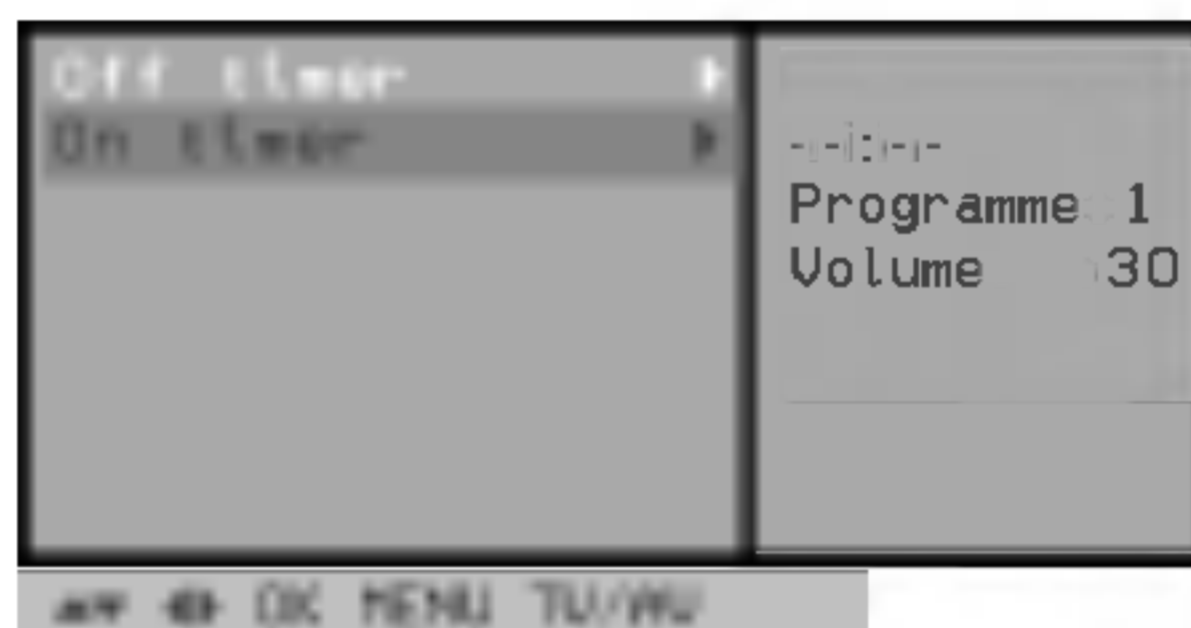

4. Press the **▶** button and then **▲ / ▼** button to select the desired timer item; **---:--**, **Programme** or **Volume**.
5. Make desired adjustment with the **◀ / ▶** button on each pull-down menu.
6. Press the **OK** button.
7. Press the **TV/AV** button to return to normal TV viewing.

You can set the on/off timer from 10 minutes up to 12 hours 50 minutes in 10 minutes steps. The timer begins to count down from the selected time period.

Note :

- a. This set must be put into standby mode with the **POWER** button on the remote control to operate the on timer function.
- b. To view the remaining on/off time, select **Timer** menu.
- c. To cancel the set on/off time, set the on/off timer to **---:--**.
- d. When you switch the power off, the on/off time is reset.

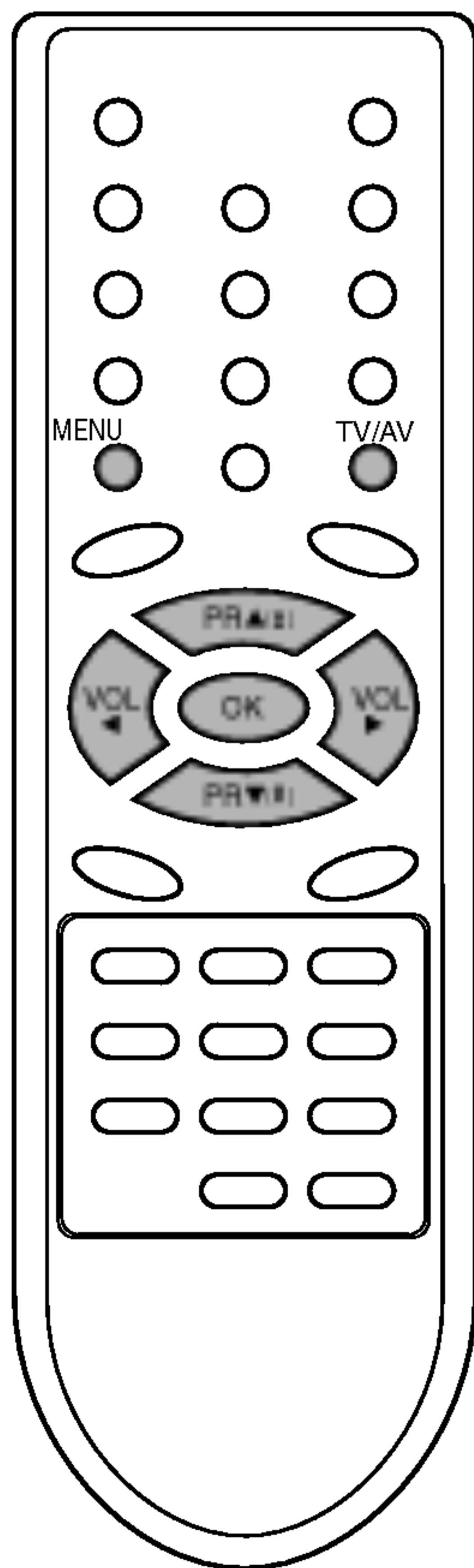

Teletext (option)

Teletext (or TOP text) is an optional function, therefore only a set with the teletext system can receive the teletext broadcast.

Teletext is a free service broadcast by most TV stations which gives up-to-the-minute information on news, weather, television programmes, share prices and many other topics.

The teletext decoder of this TV can support the SIMPLE, TOP and FASTEXT systems. SIMPLE (standard teletext) consists of a number of pages which are selected by directly entering the corresponding page number. TOP and FASTEXT are more modern methods allowing quick and easy selection of teletext information.

Switch on/off

Press the **TEXT** button to switch to teletext. The initial page or last page appears on the screen.

Two page numbers, TV station name, date and time are displayed on the screen headline. The first page number indicates your selection, while the second shows the current page displayed.

Press the **TV/AV** button to switch off teletext. The previous mode reappears.

SIMPLE text

Page selection

1. Enter the desired page number as a three digit number with the **NUMBER** buttons. If during selection you press a wrong number, you must complete the three digit number and then re-enter the correct page number.
2. The **▲ / ▼** button can be used to select the preceding or following page.

Programming a colour button in LIST mode

If the TV is in SIMPLE text, TOP text or FASTEXT mode, press the **≡M** button to switch to LIST mode.

Four teletext page numbers of your choice can be colour coded and easily selected by pressing the corresponding coloured button on the remote control handset.

1. Press a coloured button.
2. Using the **NUMBER** buttons, select the page you wish to programme.
3. Press the **OK** button. Then the selected page is stored as the selected page number by blinking once. From now on, you can select this page with the same coloured button.
4. The three other coloured buttons are programmed in this way.

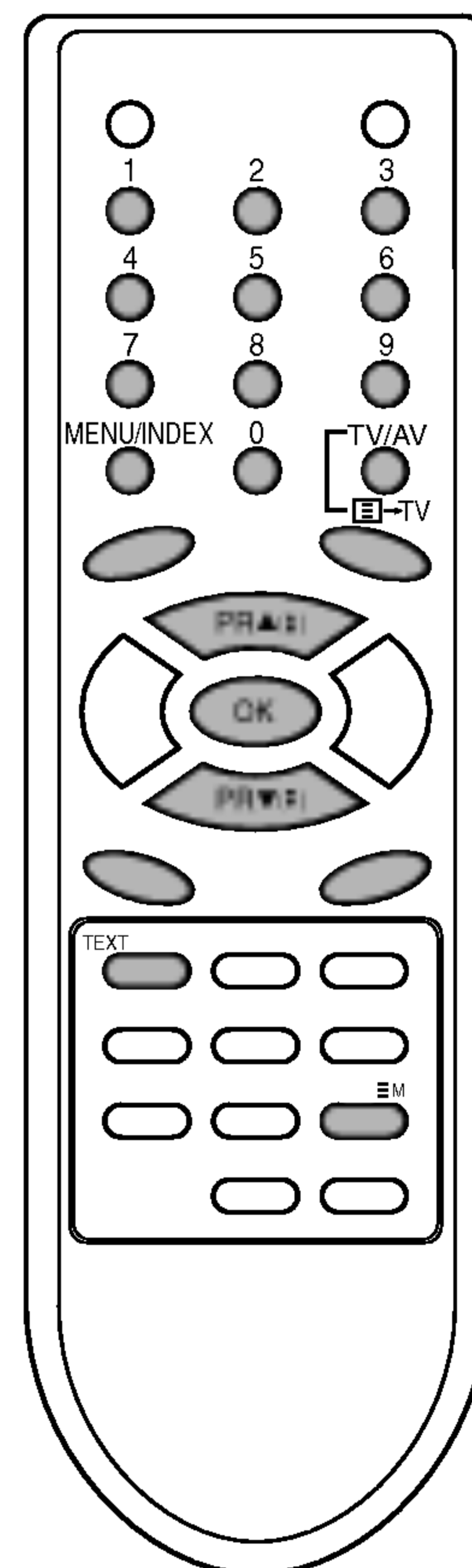

Teletext (option)

TOP text (option)

The user guide displays four fields-red, green, yellow and blue at the bottom of the screen. The yellow field denotes the next group and the blue field indicates the next block.

Block / group / page selection

1. With the blue button you can progress from block to block.
2. Use the yellow button to proceed to the next group with automatic overflow to the next block.
3. With the green button you can proceed to the next existing page with automatic overflow to the next group.
Alternatively the ▲ button can be used.
4. The red button permits to return to previous selection.
Alternatively the ▼ button can be used.

Direct page selection

Corresponding to the SIMPLE teletext mode, you can select a page by entering it as a three digit number using the NUMBER buttons in TOP mode.

FASTEXT

The teletext pages are colour coded along the bottom of the screen and are selected by pressing the corresponding coloured button.

Page selection

1. Press the **INDEX** button to select the index page.
2. You can select the pages which are colour coded along the bottom line with the same coloured buttons.
3. Corresponding to the SIMPLE teletext mode, you can select a page by entering its three digit page number with the NUMBER buttons in FASTEXT mode.
4. The ▲ / ▼ button can be used to select the preceding or following page.

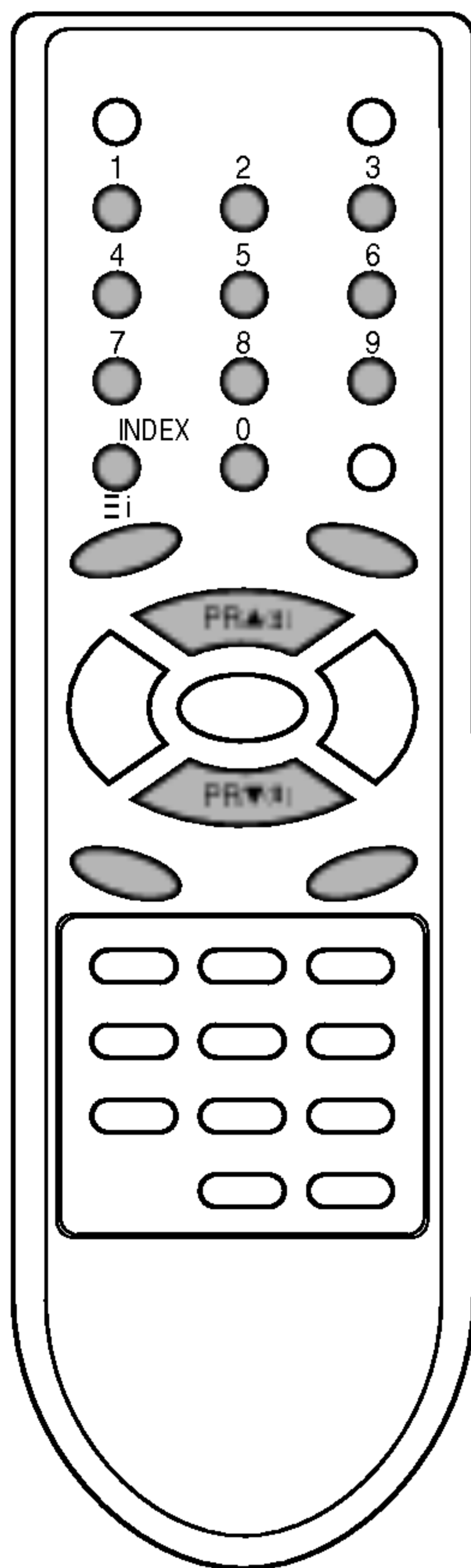

Teletext (option)

Special teletext functions

REVEAL/≡?

Press this button to display concealed information, such as solutions of riddles or puzzles.

Press this button again to remove the information from the display.

SIZE/≡⇄



Selects double height text.

Press this button to enlarge the top half of the page.

Press this button again to enlarge the bottom half of the page.

Press this button again to return to the normal display.

UPDATE/≡×

Displays the TV picture on the screen while waiting for the new teletext page. The display  will appear at the top left hand corner of the screen. When the updated page is available then display  will change to the page number.

Press this button to view the updated teletext page.

HOLD/≡⏸

Stops the automatic page change which will occur if a teletext page consists of 2 or more sub pages. The number of sub pages and the sub page displayed is, usually, shown on the screen below the time. When this button is pressed the stop symbol is displayed at the top left-hand corner of the screen and the automatic page change is inhibited. To continue press this button again.

MIX/≡⇆

Displays the teletext pages superimposed on the TV picture.

To switch the TV picture off press this button again.

TIME/≡●

When viewing a TV programme, press this button to display the time at the top right hand corner of the screen. Press this button again to remove the display. In the teletext mode, press this button to select a sub page number. The sub page number is displayed at the bottom of the screen. To hold or change the sub page, press the RED / GREEN, ▲ / ▼ or NUMBER buttons.

Press this button again to exit this function.

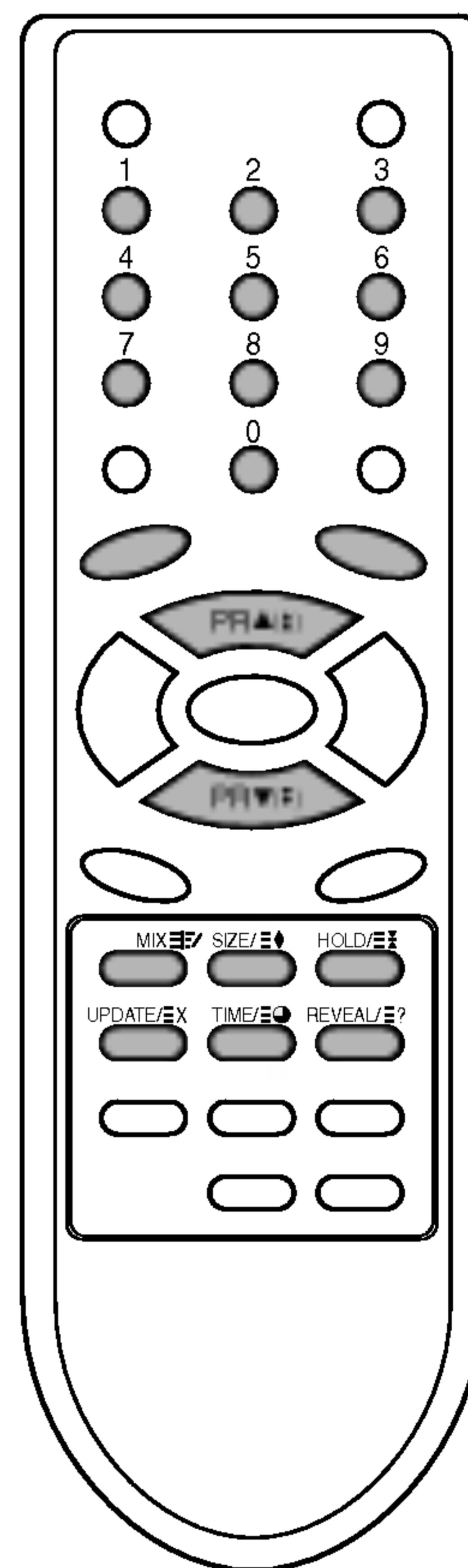

Connection of external equipment

You can connect additional equipment, such as VCRs, camcorders etc. to your set.
Here shown may be somewhat different from your set.

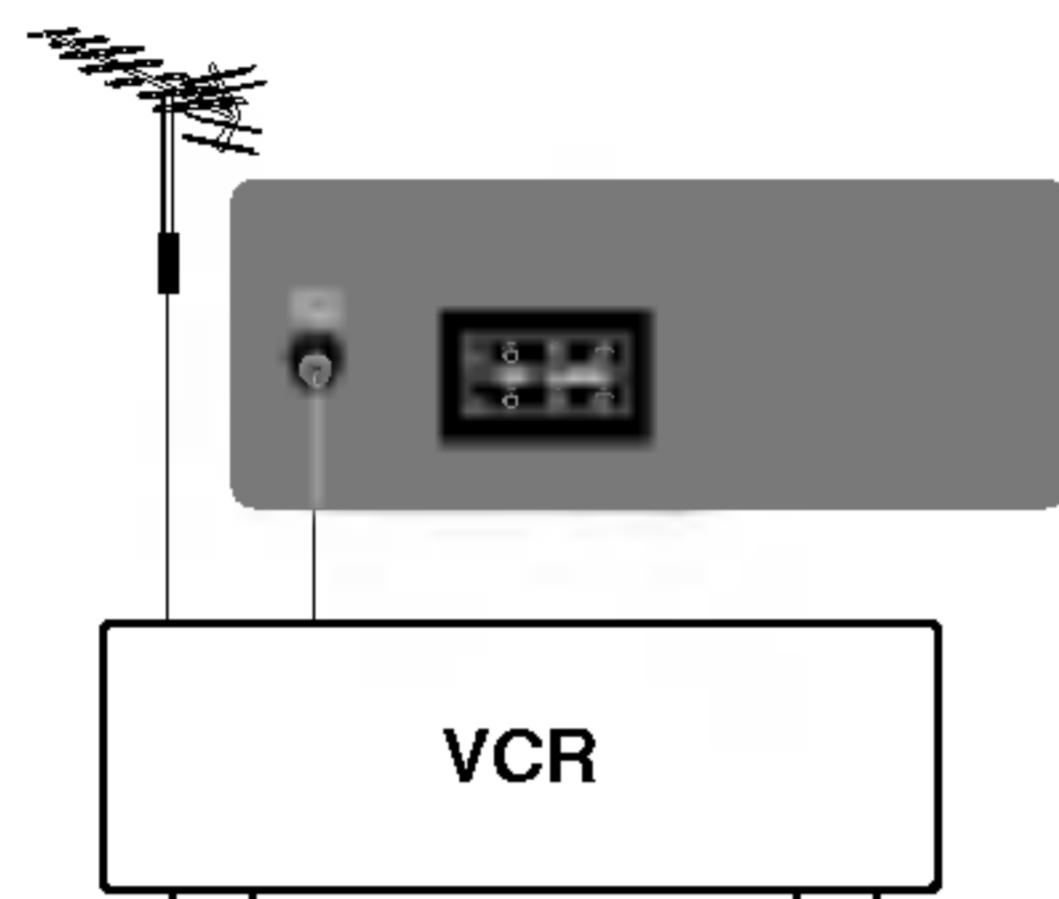

Aerial socket

1. Connect the RF out socket of the VCR to the aerial socket on the back of the set.
2. Connect the aerial cable to the RF aerial in socket of the VCR.
3. Store the VCR channel on the programme number 0 using the 'Manual programme tuning' section.
4. Select the programme number where the VCR channel is stored.
5. Press the **PLAY** button on the VCR.

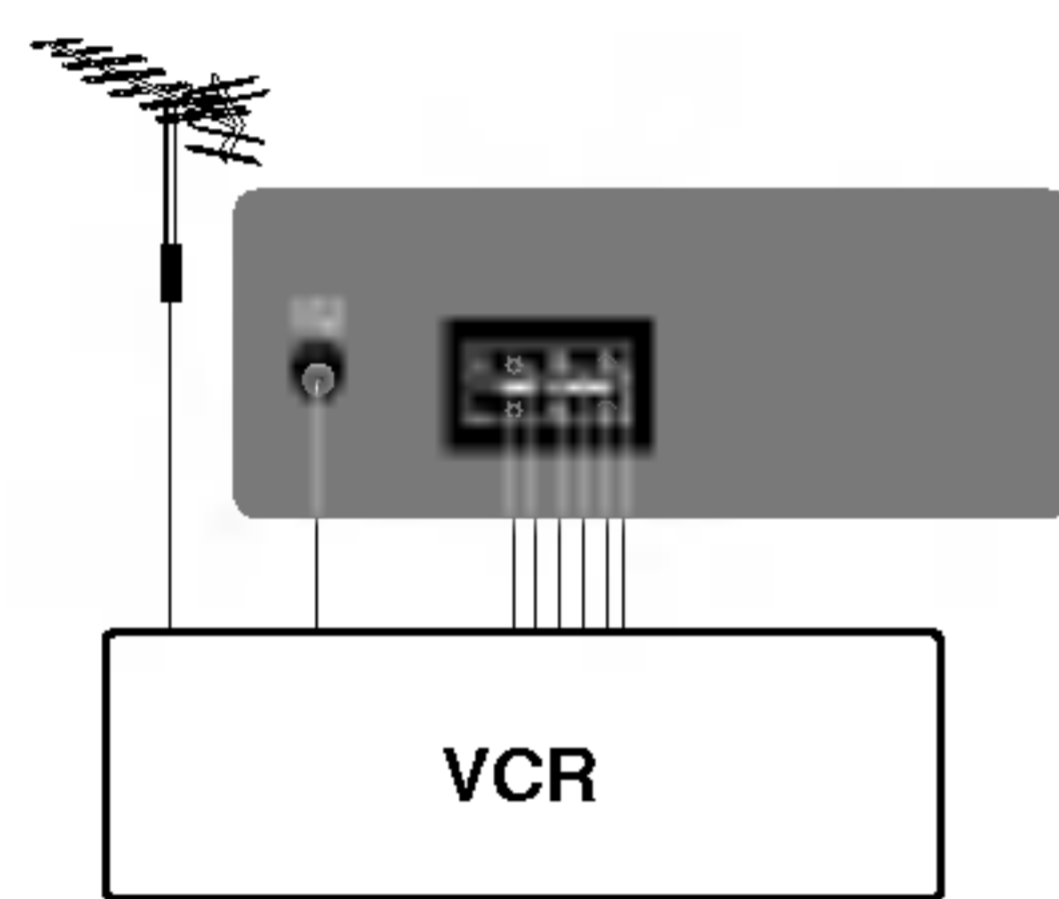

Audio(or Audio-L/R)/Video in/out sockets (option)

1. Connect the audio/video out sockets of the VCR to the Audio (or Audio-L/R)/video in sockets of the set and in sockets of the VCR to out sockets of the set.
2. If the VCR is connected to the AV sockets on the set, press the **TV/AV** button to select **AV**.
3. Press the **PLAY** button on the VCR.
The VCR playback picture appears on the screen.

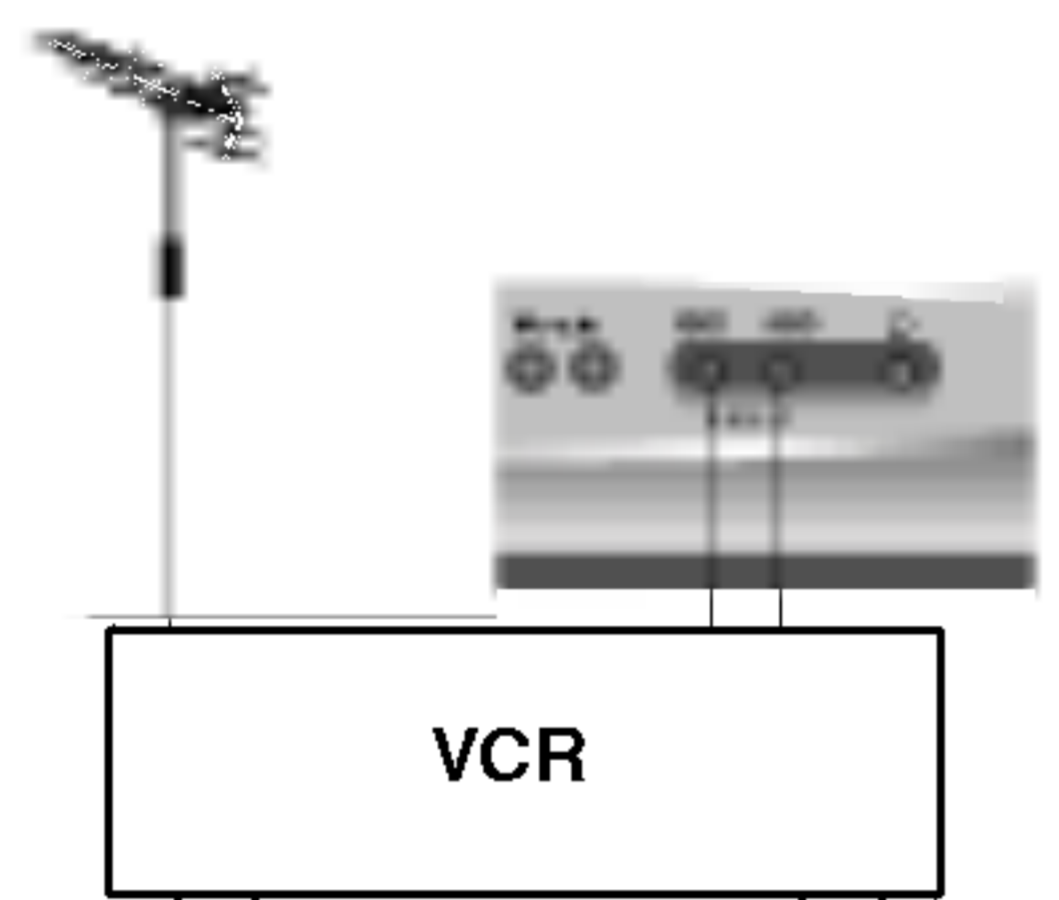

You can also record programmes received by the TV on video tape via audio/video out sockets.

Note :

- a. If both the input jacks on the front/side panel and back panel have been connected to external equipments simultaneously, only the input jacks on the front/side panel can be received.
- b. In the mono models with cricket and car racing games, the TV screen picture isn't output through the audio/video out sockets.

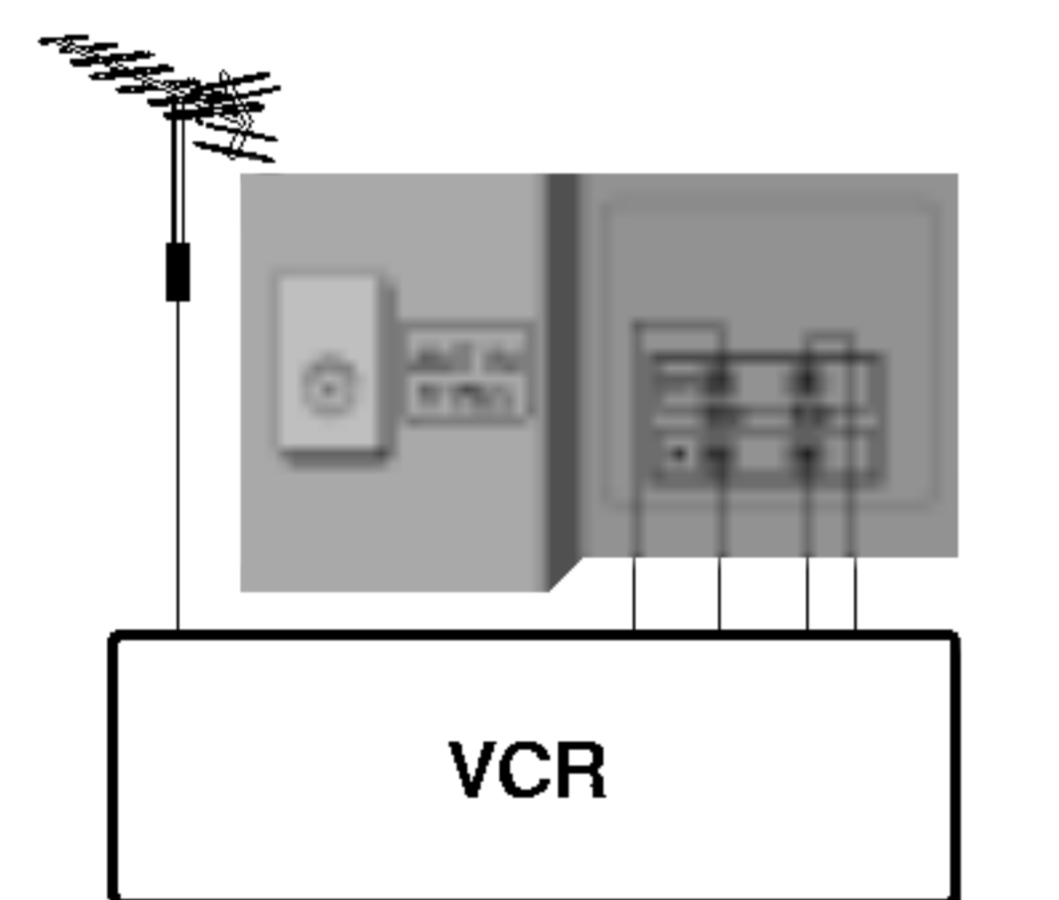

Euro scart socket (option)

1. Connect the Euro scart socket of the VCR to the Euro scart socket of the set.
2. Press the **PLAY** button on the VCR.
If your VCR outputs a switching voltage when connected to a Euro scart socket, the set will switch to **AV** mode automatically. But if you want to keep on watching TV mode, press the **▲ / ▼** or **NUMBER** buttons.

Otherwise press the **TV/AV** button on the remote control hand-set to select **AV**. The VCR playback picture appears on the screen.

You can also record programmes received by the TV on video tape.

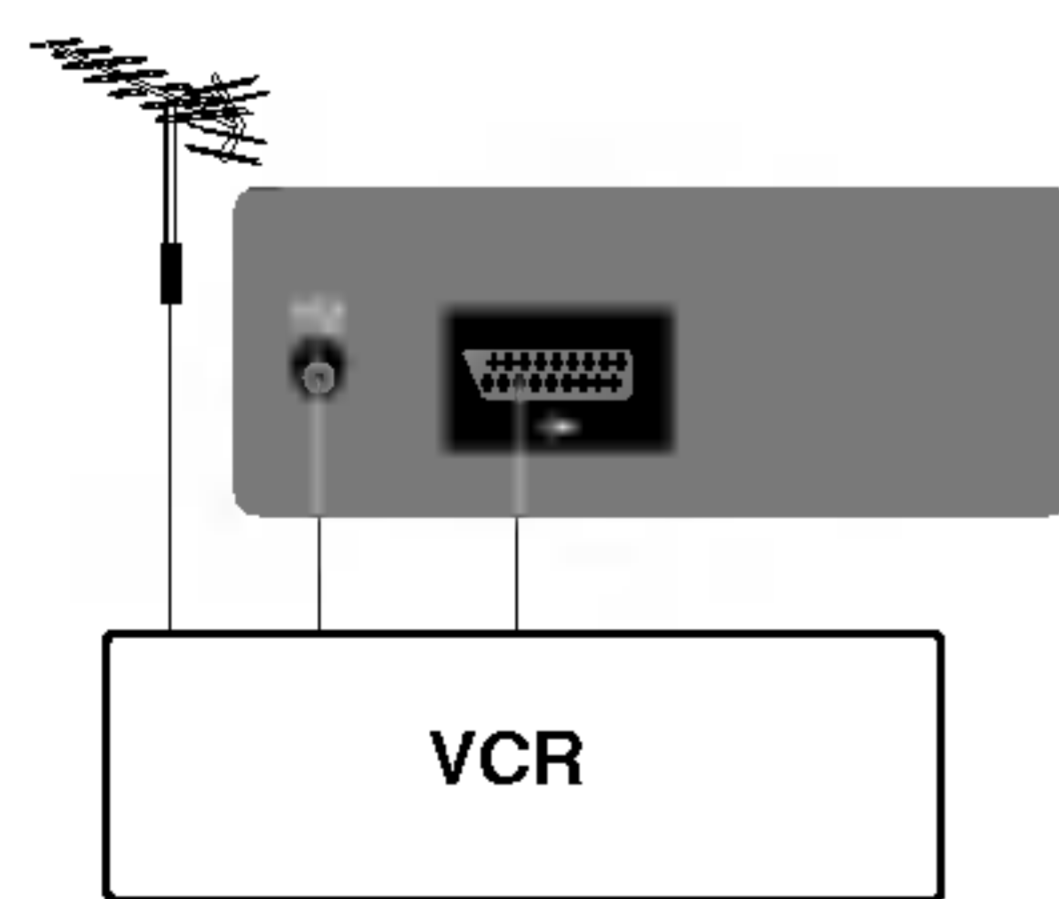

Note : If you want to watch the signals from the input jacks on the front/side panel, disconnect the Euro scart socket of the VCR from the Euro scart socket on the back of the set.

Connection of external equipment

Headphone socket (option)

In some models which have a headphone socket can perform this function.

Insert the headphone plug to the headphone socket of the set. You can listen to the sound through the headphone. To adjust the headphone volume, press the ◀ / ▶ button.

If you press the **MUTE** button, the sound from the headphone's is switched off.

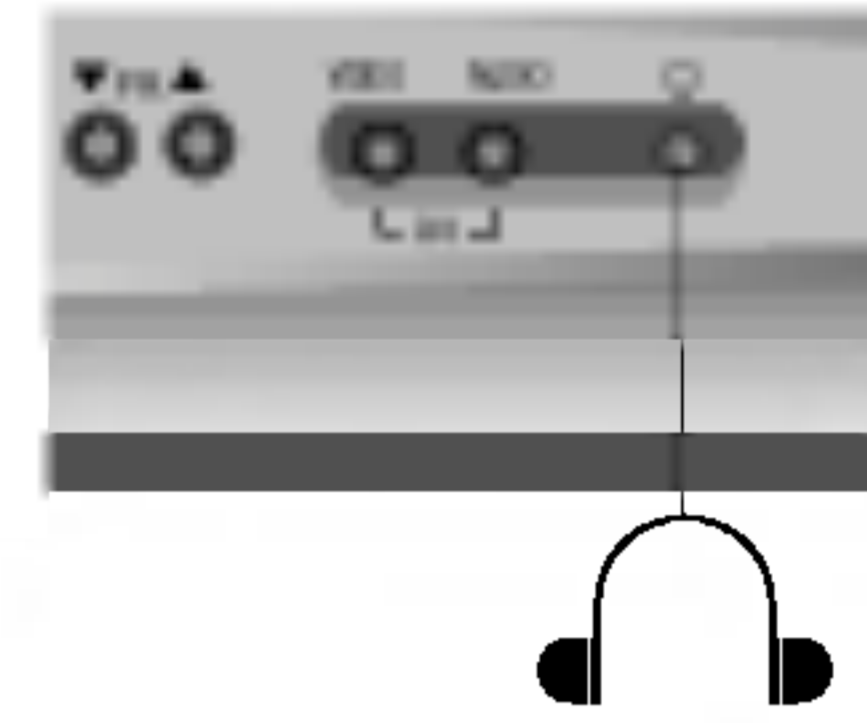

Troubleshooting check list

Symptoms

No picture, no sound

Sound OK, poor picture

Picture OK, poor sound

Picture blurred

Lines or streaks in picture

Poor reception on some channels

No colour

Poor colour

Remote control does not work

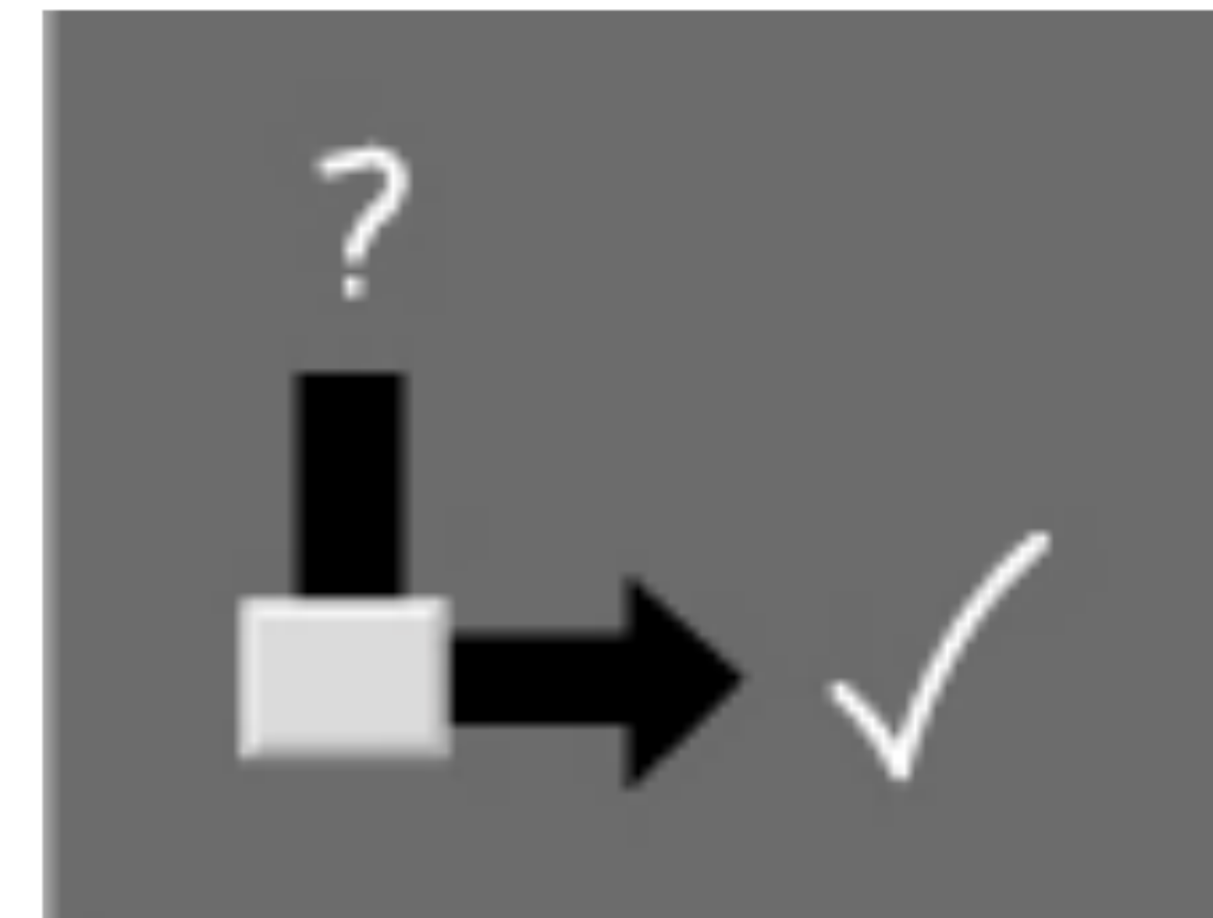

Check these items and try to adjust these

<input type="checkbox"/>	<input type="checkbox"/>	<input type="checkbox"/>	<input type="checkbox"/>	<input type="checkbox"/>	<input type="checkbox"/>	<input type="checkbox"/>	<input type="checkbox"/>	<input type="checkbox"/>	<input type="checkbox"/>
<input type="checkbox"/>	<input type="checkbox"/>	<input type="checkbox"/>	<input type="checkbox"/>	<input type="checkbox"/>	<input type="checkbox"/>	<input type="checkbox"/>	<input type="checkbox"/>	<input type="checkbox"/>	<input type="checkbox"/>
<input type="checkbox"/>	<input type="checkbox"/>	<input type="checkbox"/>	<input type="checkbox"/>	<input type="checkbox"/>	<input type="checkbox"/>	<input type="checkbox"/>	<input type="checkbox"/>	<input type="checkbox"/>	<input type="checkbox"/>
<input type="checkbox"/>	<input type="checkbox"/>	<input type="checkbox"/>	<input type="checkbox"/>	<input type="checkbox"/>	<input type="checkbox"/>	<input type="checkbox"/>	<input type="checkbox"/>	<input type="checkbox"/>	<input type="checkbox"/>
<input type="checkbox"/>	<input type="checkbox"/>	<input type="checkbox"/>	<input type="checkbox"/>	<input type="checkbox"/>	<input type="checkbox"/>	<input type="checkbox"/>	<input type="checkbox"/>	<input type="checkbox"/>	<input type="checkbox"/>
<input type="checkbox"/>	<input type="checkbox"/>	<input type="checkbox"/>	<input type="checkbox"/>	<input type="checkbox"/>	<input type="checkbox"/>	<input type="checkbox"/>	<input type="checkbox"/>	<input type="checkbox"/>	<input type="checkbox"/>
<input type="checkbox"/>	<input type="checkbox"/>	<input type="checkbox"/>	<input type="checkbox"/>	<input type="checkbox"/>	<input type="checkbox"/>	<input type="checkbox"/>	<input type="checkbox"/>	<input type="checkbox"/>	<input type="checkbox"/>
<input type="checkbox"/>	<input type="checkbox"/>	<input type="checkbox"/>	<input type="checkbox"/>	<input type="checkbox"/>	<input type="checkbox"/>	<input type="checkbox"/>	<input type="checkbox"/>	<input type="checkbox"/>	<input type="checkbox"/>
<input type="checkbox"/>	<input type="checkbox"/>	<input type="checkbox"/>	<input type="checkbox"/>	<input type="checkbox"/>	<input type="checkbox"/>	<input type="checkbox"/>	<input type="checkbox"/>	<input type="checkbox"/>	<input type="checkbox"/>
<input type="checkbox"/>	<input type="checkbox"/>	<input type="checkbox"/>	<input type="checkbox"/>	<input type="checkbox"/>	<input type="checkbox"/>	<input type="checkbox"/>	<input type="checkbox"/>	<input type="checkbox"/>	<input type="checkbox"/>
<input type="checkbox"/>	<input type="checkbox"/>	<input type="checkbox"/>	<input type="checkbox"/>	<input type="checkbox"/>	<input type="checkbox"/>	<input type="checkbox"/>	<input type="checkbox"/>	<input type="checkbox"/>	<input type="checkbox"/>
<input type="checkbox"/>	<input type="checkbox"/>	<input type="checkbox"/>	<input type="checkbox"/>	<input type="checkbox"/>	<input type="checkbox"/>	<input type="checkbox"/>	<input type="checkbox"/>	<input type="checkbox"/>	<input type="checkbox"/>
<input type="checkbox"/>	<input type="checkbox"/>	<input type="checkbox"/>	<input type="checkbox"/>	<input type="checkbox"/>	<input type="checkbox"/>	<input type="checkbox"/>	<input type="checkbox"/>	<input type="checkbox"/>	<input type="checkbox"/>
<input type="checkbox"/>	<input type="checkbox"/>	<input type="checkbox"/>	<input type="checkbox"/>	<input type="checkbox"/>	<input type="checkbox"/>	<input type="checkbox"/>	<input type="checkbox"/>	<input type="checkbox"/>	<input type="checkbox"/>

The mains plug-(plugged in and switched on)

Is the TV switched on

Try another channel (weak signal)

Check aerial (plugged into TV?)

Check aerial (broken lead?)

Check aerial

Check for local interference

Adjust contrast

Adjust brightness

Adjust colour

Adjust volume

Check the batteries in remote control

Check Audio/Video sockets (VCR only)