

User's Guide

L2300B L2300C

Make sure to read the **Important Precautions** before using the product.
Keep the User's Guide(CD) in an accessible place for future reference.

See the label attached on the back cover and quote this information to your dealer when you require service.

This unit has been engineered and manufactured to ensure your personal safety, however improper use may result in potential electrical shock or fire hazards. In order to allow the proper operation of all safeguards incorporated in this display, observe the following basic rules for its installation, use, and servicing.

On Safety

Use only the power cord supplied with the unit. In case you use another power cord, make sure that it is certified by the applicable national standards if not being provided by the supplier. If the power cable is faulty in any way, please contact the manufacturer or the nearest authorized repair service provider for a replacement.

The power supply cord is used as the main disconnection device. Ensure that the socket-outlet is easily accessible after installation.

Operate the display only from a power source indicated in the specifications of this manual or listed on the display. If you are not sure what type of power supply you have in your home, consult with your dealer.

Overloaded AC outlets and extension cords are dangerous. So are frayed power cords and broken plugs. They may result in a shock or fire hazard. Call your service technician for replacement.

Do not Open the Display.

- There are no user serviceable components inside.
- There are Dangerous High Voltages inside, even when the power is off.
- Contact your dealer if the display is not operating properly.

To Avoid Personal Injury :

- Do not place the display on a sloping shelf unless properly secured.
- Use only a stand recommended by the manufacturer.

To Prevent Fire or Hazards:

- Always turn the display OFF if you leave the room for more than a short period of time. Never leave the display ON when leaving the house.
- Keep children from dropping or pushing objects into the display's cabinet openings. Some internal parts carry hazardous voltages.
- Do not add accessories that have not been designed for this display.
- During a lightning storm or when the display is to be left unattended for an extended period of time, unplug it from the wall outlet.

On Installation

Do not allow anything to rest upon or roll over the power cord, and do not place the display where the power cord is subject to damage.

Do not use this display near water such as near a bathtub, washbowl, kitchen sink, laundry tub, in a wet basement, or near a swimming pool.

Displays are provided with ventilation openings in the cabinet to allow the release of heat generated during operation. If these openings are blocked, built-up heat can cause failures which may result in a fire hazard. Therefore, NEVER:

- Block the bottom ventilation slots by placing the display on a bed, sofa, rug, etc.
- Place the display in a built-in enclosure unless proper ventilation is provided.
- Cover the openings with cloth or other material.
- Place the display near or over a radiator or heat source.

Do not rub or strike the Active Matrix LCD with anything hard as this may scratch, mar, or damage the Active Matrix LCD permanently.

Do not press the LCD screen with your finger for a long time as this may cause some afterimages.

Some dot defects may appear as Red, Green or Blue spots on the screen. However, this will have no impact or effect on the display performance.

If possible, use the recommended resolution to obtain the best image quality for your LCD display. If used under any mode except the recommended resolution, some scaled or processed images may appear on the screen. However, this is characteristic of the fixed-resolution LCD panel.

On Cleaning

- Unplug the display before cleaning the face of the display screen.
- Use a slightly damp (not wet) cloth. Do not use an aerosol directly on the display screen because over-spraying may cause electrical shock.

On Repacking

- Do not throw away the carton and packing materials. They make an ideal container in which to transport the unit. When shipping the unit to another location, repack it in its original material.

On Disposal

- The fluorescent lamp used in this product contains a small amount of mercury.
- Do not dispose of this product with general household waste. Disposal of this product must be carried out in accordance to the regulations of your local authority.

- Before setting up the monitor, ensure that the power to the monitor, the computer system, and other attached devices is turned off.

Positioning your display

1. Adjust the position of the panel in various ways for maximum comfort.

- Tilt Range : $-5^{\circ} \sim 30^{\circ}$

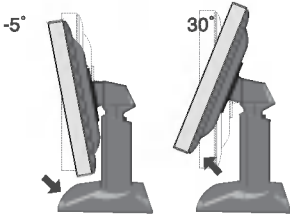

- Swivel : 90°

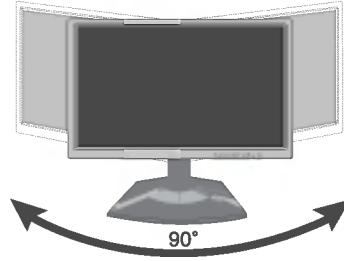

- Height Range : maximum 3.15 inch (80.0mm)

Unfasten the [Stand lock] counterclockwise to adjust the height of the stand.

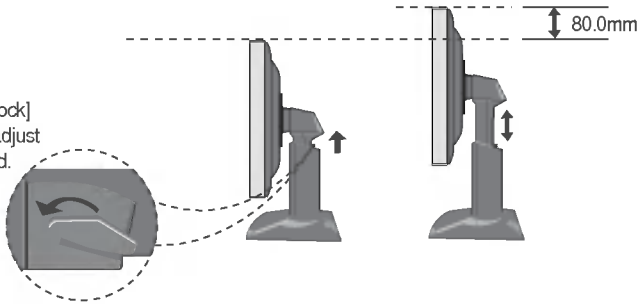

Ergonomic

It is recommended that in order to maintain an ergonomic and comfortable viewing position, the forward tilt angle of the monitor should not exceed 5 degrees.

Using the Computer

1. Place the monitor in a convenient, well-ventilated location near your computer.
To adjust height of your monitor, unlock the stand lock on top of the stand.
2. Connect the signal cable. When attached, tighten the thumbscrews to secure the connection.
3. Connect the power cord into a proper power outlet that is easily accessible and close to the display.

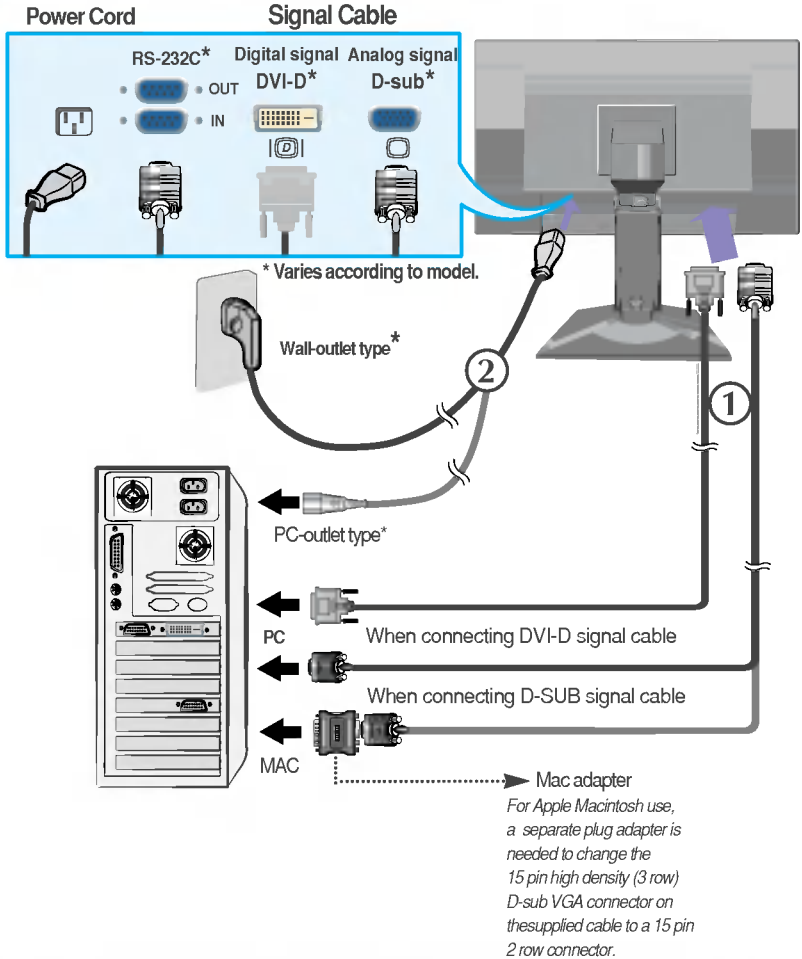

NOTE

- This is a simplified representation of the rear view.
- This rear view represents a general model; your display may differ from the view as shown.

To arrange cables in order

1. Press the **push button**, and pull the **stand cover** down to separate it from the stand.

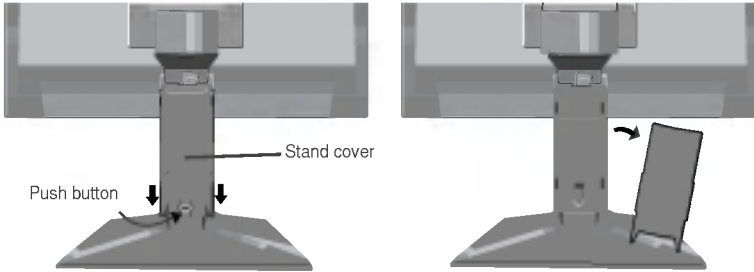



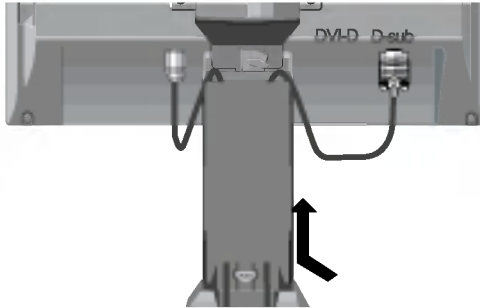

2. After connecting cables, put the **stand cover** correctly into the holes on the stand. If securely connected, you can hear the click sound from the latch.

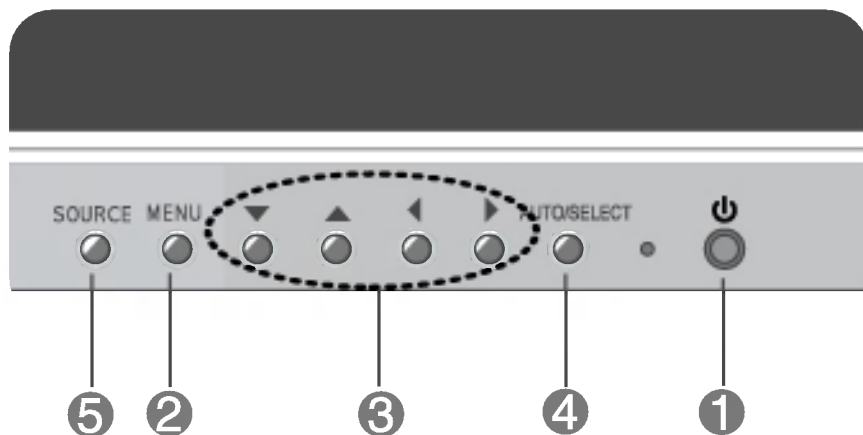

Front Panel Controls

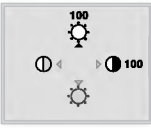

Control	Function
1 Power Button Power (DPMS) Indicator	Use this button to turn the display on or off. This Indicator lights up green when the display operates normally. If the display is in DPM (Energy Saving) mode, this indicator color changes to amber.
2 MENU Button	Use this button to enter or exit the On Screen Display.
3 ▼▲◀▶ Buttons	Use these buttons to choose or adjust items in the On Screen Display.
4 AUTO/SELECT Button	Use this button to enter a selection in the On Screen Display.

Control	Direct Access Function
	<p>3 ▼▲◀▶</p> <p>Bring up Contrast and Brightness adjustment.</p>
	<p>4 AUTO adjustment function</p> <p>When adjusting your display settings, always press the AUTO/SELECT button before entering the On Screen Display(OSD). This will automatically adjust your display image to the ideal settings for the current screen resolution size (display mode).</p> <p>The best display mode is L2300B monitor : 1920x1200@60Hz L2300C monitor : 1360x768@60Hz</p>
	<p>5 SOURCE Selection: SOURCE → ▼▲ → AUTO/SELECT</p> <p>Use this button to make DVI DIGITAL, DSUB ANALOG connector active. This feature is used when two computers are connected to the display. The default setting is Dsub.</p> <ul style="list-style-type: none">• DVI DIGITAL• DSUB ANALOG
 	<p>CONTROLS LOCKED/UNLOCKED: MENU and ▶</p> <p>This function allows you to secure the current control settings, so that they cannot be inadvertently changed. Press and hold the MENU button and ▶ button for 5 seconds: the message “CONTROLS LOCKED” appears. You can unlock the OSD controls at any time by pushing the MENU button and ▶ button for 5 seconds: the message “CONTROLS UNLOCKED” will appear.</p>

Screen Adjustment

Making adjustments to the image size, position and operating parameters of the display is quick and easy with the On Screen Display Control system. A short example is given below to familiarize you with the use of the controls. The following section is an outline of the available adjustments and selections you can make using the OSD.

NOTE

- Allow the display to stabilize for at least 30 minutes before making image adjustments.

To make adjustments in the On Screen Display, follow these steps:

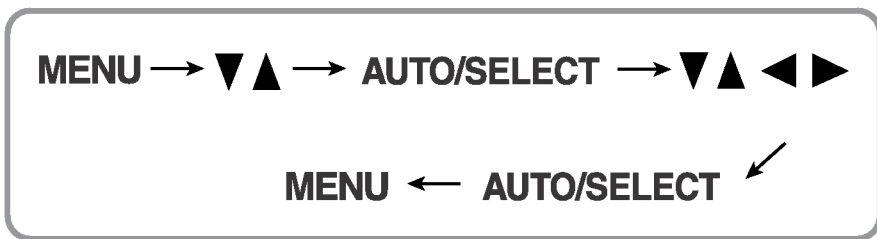

- 1 Press the **MENU Button**, then the main menu of the OSD appears.
- 2 To access a control, use the **▼** or **▲ Buttons**. When the icon you want becomes highlighted, press the **AUTO/SELECT Button**.
- 3 Use the **▼ ▲ ◀ ▶ Buttons** to adjust the item to the desired level.
- 4 Accept the changes by pressing the **AUTO/SELECT Button**.
- 5 Exit the OSD by pressing the **MENU Button**.

On Screen Display(OSD) Selection and Adjustment

The following table indicates all the On Screen Display control, adjustment, and setting menus.

Main menu	Sub menu	A	D	Reference
CONTRAST/ BRIGHTNESS	CONTRAST	●	●	To adjust the brightness and contrast of the screen
	BRIGHTNESS	●	●	
COLOR ADJUSTMENT	USER(R/G/B)	●	●	To customize the color of the screen
	9300K	●	●	
	6500K	●	●	
IMAGE POSITION	H POSITION	●		To adjust the position of the screen
	V POSITION	●		
TRACKING	AUTO	●		To improve the clarity and stability of the screen
	CLOCK	●		
	PHASE	●		
SETUP	LANGUAGE	●	●	To customize the screen status for a user's operating environment
	IMAGE SIZE	●	●	
	TRANSPARENCY	●	●	
	ZOOM	●	●	
	SET ID	●	●	
OSD POSITION	HORIZONTAL	●	●	To adjust position of the OSD window on the screen
	VERTICAL	●	●	
● : Adjustable A : Analog Input D : Digital Input				

NOTE



- The order of icons may differ depending on the model (A9-A12).

You were introduced to the procedure of selecting and adjusting an item using the OSD system. Listed below are the icons, icon names, and icon descriptions of the all items shown on the Menu.

NOTE

- OSD (On Screen Display) menu languages on the monitor may differ from the manual.

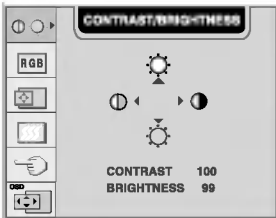

To adjust the brightness and contrast of the screen

OSD Adjust	Description	
 The OSD menu for Contrast and Brightness adjustment. It features a left sidebar with icons for OSD, RGB, and other settings. The main area is titled 'CONTRAST, BRIGHTNESS' and contains two circular sliders. The top slider is for Contrast, with a value of 100. The bottom slider is for Brightness, with a value of 99.	 CONTRAST To adjust the contrast of the screen.	 BRIGHTNESS To adjust the brightness of the screen.

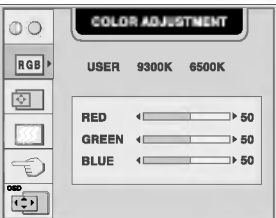
To customize the color of the screen

OSD Adjust	Description	
 The OSD menu for Color Adjustment. It features a left sidebar with icons for OSD, RGB, and other settings. The main area is titled 'COLOR ADJUSTMENT' and shows 'USER' color levels for 9300K and 6500K. Below are three sliders for RED, GREEN, and BLUE, each with a value of 50.	USER RED/GREEN/BLUE Set your own color levels.	9300K Select the screen color. <ul style="list-style-type: none">9300K: Slightly bluish white.6500K: Slightly reddish white.

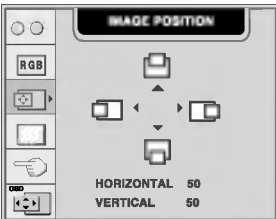
To adjust the position of the screen

OSD Adjust	Description	
 The OSD menu for Image Position adjustment. It features a left sidebar with icons for OSD, RGB, and other settings. The main area is titled 'IMAGE POSITION' and contains four directional arrows (up, down, left, right) around a central monitor icon. Below are two sliders: HORIZONTAL (value 50) and VERTICAL (value 50).	 Horizontal Position To move image left and right.	 Vertical Position To move image up and down.

To improve the clarity and stability of the screen

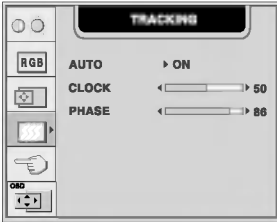
OSD Adjust	Description
	<p>AUTO This function is suitable for analog signal input only. This button is for the automatic adjustment of the screen position, clock and phase.</p> <p>CLOCK To minimize any vertical bars or stripes visible on the screen background. The horizontal screen size will also change.</p> <p>PHASE To adjust the focus of the display. This item allows you to remove any horizontal noise and clear or sharpen the image of characters. Phase adjustment should be done after adjusting the Clock.</p>

To customize the screen status for a user's operating environment

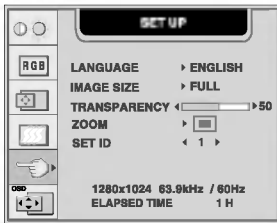
OSD Adjust	Description
	<p>LANGUAGE To choose the language in which the control names are displayed.</p> <p>IMAGE SIZE This function displays the image in its original size or enlarged size so as to fit in the full screen of the LCD panel.</p> <p>TRANSPARENCY To adjust the transparency of the OSD menu screen.</p> <p>ZOOM To adjust horizontal and vertical image size simultaneously. If you want to move the zooming point, use the H/V POSITION function in the sub-menu. However, if the monitor turns off when zooming in and out the screen, the monitor will be returned to original screen.</p> <p>SET ID You can assign a unique SET ID NO (name assignment) to each monitor when several monitors are connected for display. Specify the number (0 ~ 99) using the ◀▶ button and exit. Use the assigned SET ID to individually control each monitor using the Monitor Control Program.</p>

To adjust position of the OSD window on the screen

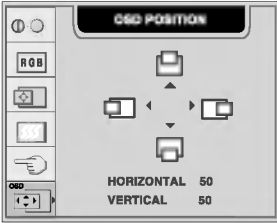
OSD Adjust	Description
 <p>The screenshot shows the OSD POSITION menu. On the left is a vertical navigation bar with icons for menu, return, and other functions. The main area is titled 'OSD POSITION' and features a central graphic with four arrows pointing up, down, left, and right, each accompanied by a small monitor icon. Below this graphic, the text reads 'HORIZONTAL 50' and 'VERTICAL 50'.</p>	<p>Horizontal Position To adjust horizontal position of the OSD window on the screen.</p> <p>Vertical Position To adjust vertical position of the OSD window on the screen.</p>

Use this method to connect several monitors to a single PC.

You can control several monitors at a time by connecting them to a single PC.

Connecting the cable

Connect the RS-232C cable as shown in the picture.

* The RS-232C protocol is used for communication between the PC and monitor.
You can turn the monitor on/off, select an input source or adjust the OSD menu from your PC.

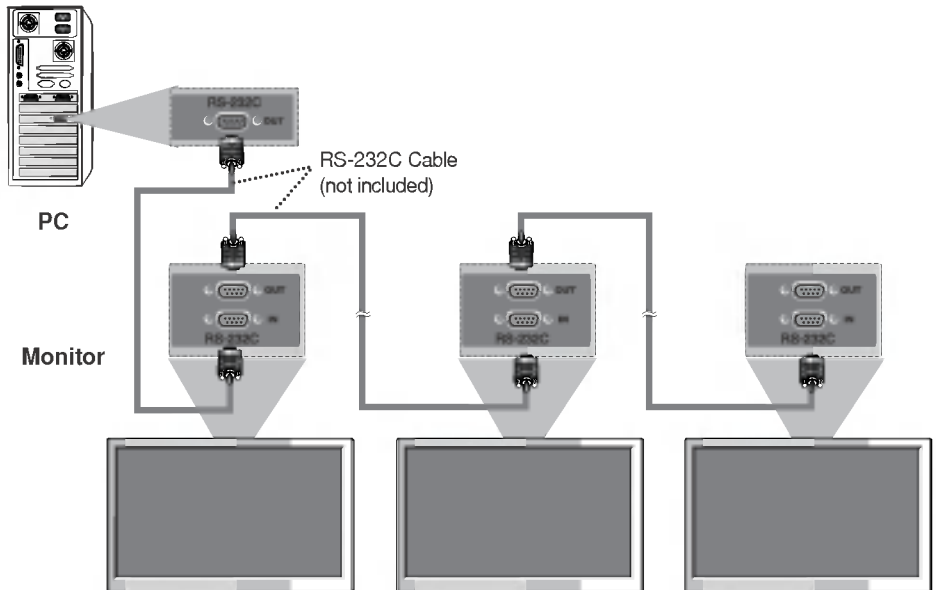

Communication Parameter

- ▶ Baud Rate : 9600bps
- ▶ Data Length : 8bits
- ▶ Parity Bit : NONE
- ▶ Stop Bit : 1bit
- ▶ Flow Control : NONE

Command Reference List

	COMMAND1	COMMAND2	DATA(Hexa)
01. Power	k	a	0, 1
02. Input Select	k	b	6, 8
03. Image Size	k	c	1, 2, 6
04. Contrast	k	g	0 - 64
05. Brightness	k	h	0 - 64
06. Key Lock	k	m	0, 1
07. Color	k	u	0, 2
08. Auto Configure	j	u	01H

Transmission / Receiving Protocol

Transmission

`[Command1][Command2][][Set ID][][Data][Cr]`

- * [Command 1]: First command.
- * [Command 2]: Second command.
- * [Set ID]: You can adjust the set ID to choose desired monitor ID number in Setup menu. Adjustment range is 0~99. When selecting Set ID '0', every connected monitor set is controlled. Set ID is indicated as decimal (0~99) on menu and as Hexa decimal (0x0~0x64) on transmission/receiving protocol.
- * [DATA]: To transmit command data.
Transmit 'FF' data to read status of command.
- * [Cr]: Carriage Return
ASCII code '0x0D'
- * []: ASCII code Space (0x20)

OK Acknowledgement

`[Command2][][Set ID][][OK][Data][x]`

- * The Monitor transmits ACK (acknowledgement) based on this format when receiving normal data. At this time, if the data is data read mode, it indicates present status data. If the data is data write mode, it returns the data of the PC computer.

Error Acknowledgement

`[Command2][][Set ID][][NG][Data][x]`

- * The Monitor transmits ACK (acknowledgement) based on this format when receiving abnormal data from non-viable functions or communication errors.

- Data 1: Illegal Code
 2: Not supported function
 3: Wait more time

● Transmission / Receiving Protocol

1. Power On (Command:a)

- ▶ To control Power On/Off of the monitor.

Transmission

[k][a][][Set ID][][Data][Cr]

Data 0 : Power Off 1 : Power On

Acknowledgement

[a][][Set ID][][OK][Data][x]

- ▶ To show Power On/Off.

Transmission

[k][a][][Set ID][][FF][Cr]

Data 0 : Power Off 1 : Power On

Acknowledgement

[a][][Set ID][][OK][Data][x]

2. Input Select (Command:b) (Main Picture Input)

- ▶ To select input source for the monitor.
You can also select an input source using the front panel controls on the monitor.

Transmission

[k][b][][Set ID][][Data][Cr]

Data 6 : DSUB ANALOG
8 : DVI DIGITAL

Acknowledgement

[b][][Set ID][][OK][Data][x]

3. Size(Command:c)

- ▶ To adjust the screen format.
You can also adjust the screen format in the Setup menu.

Transmission

[k][c][][Set ID][][Data][Cr]

Data 1, 2 : full
6 : (1 : 1)

Acknowledgement

[c][][Set ID][][OK][Data][x]

Transmission / Receiving Protocol

4. Contrast (Command:g)

- ▶ To adjust screen contrast.

You can also adjust contrast in the Contrast/Brightness menu.

Transmission

[k][g][][Set ID][][Data][Cr]

Data Min : 0 ~ Max : 64

- Refer to 'Real data mapping' as shown below.

Acknowledgement

[g][][Set ID][][OK][Data][x]

* Real data mapping

0 : Step 0

⋮

A : Step 10 (SET ID 10)

⋮

F : Step 15 (SET ID 15)

10 : Step 16 (SET ID 16)

⋮

64 : Step 100

5. Brightness (Command:h)

- ▶ To adjust screen brightness.

You can also adjust brightness in the Contrast/Brightness menu.

Transmission

[k][h][][Set ID][][Data][Cr]

Data Min : 0 ~ Max : 64

- Refer to 'Real data mapping' as shown below.

Acknowledgement

[h][][Set ID][][OK][Data][x]

* Real data mapping

0 : Step 0

⋮

A : Step 10 (SET ID 10)

⋮

F : Step 15 (SET ID 15)

10 : Step 16 (SET ID 16)

⋮

64 : Step 100

● Transmission / Receiving Protocol

6. Key Lock (Command:m)

- ▶ To lock the front panel controls on the monitor.

Transmission

[k][m][][Set ID][][Data][Cr]

Data 0 : Lock off 1 : Lock on

Acknowledgement

[m][][Set ID][][OK][Data][x]

→ If you're not using the front panel controls on the monitor, use this mode.

7. Color (Command:U)

- ▶ To adjust the screen color.
You can also adjust color in the Color adjustment menu.

Transmission

[k][u][][Set ID][][Data][Cr]

Data 0 : 9300K
2 : 6500K
3 : USER

Acknowledgement

[u][][Set ID][][OK][Data][x]

8. Auto Configure (Command : j u)

- ▶ To adjust picture position and minimize image shaking automatically. it works only in RGB(PC) mode.

Transmission

[j][u][][Set ID][][Data][Cr]

Data 1 : To Set

Acknowledgement

[u][][Set ID][][OK][Data][X]

Check the following before calling for service.

No image appears	
● Is the power cord of the display connected?	<ul style="list-style-type: none">• Check and see if the power cord is connected properly to the power outlet.
● Is the power indicator light on?	<ul style="list-style-type: none">• Press the Power button.
● Is the power on and the power indicator green?	<ul style="list-style-type: none">• Adjust the brightness and the contrast.
● Is the power indicator amber?	<ul style="list-style-type: none">• If the display is in power saving mode, try moving the mouse or pressing any key on the keyboard to bring up the screen.• Make sure if the power is on.• Try to turn on the PC.
● Do you see an "OUT OF RANGE" message on the screen?	<ul style="list-style-type: none">• This message appears when the signal from the PC (video card) is out of horizontal or vertical frequency range of the display. See the 'Specifications' section of this manual and configure your display again.
● Do you see a "CHECK SIGNAL CABLE" message on the screen?	<ul style="list-style-type: none">• This message appears when the signal cable between your PC and your display is not connected. Check the signal cable and try again.

Do you see a "CONTROLS LOCKED" message on the screen.	
● Do you see "CONTROLS LOCKED" when you push MENU button?	<ul style="list-style-type: none">• You can secure the current control settings, so that they cannot be inadvertently changed. You can unlock the OSD controls at any time by pushing the MENU button and ► button for 5 seconds: the message "CONTROLS UNLOCKED" will appear.

Display image is incorrect

- **Display Position is incorrect.**
 - Press the **AUTO/SELECT** button to automatically adjust your display image to the ideal setting.
If the results are unsatisfactory, adjust the image position using the **H position and V position** icon in the on screen display.
 - Check **Control Panel --> Display --> Settings** and see if the frequency or the resolution were changed. If yes, readjust the video card to the recommend resolution.

- **On the screen background, vertical bars or stripes are visible.**
 - Press the **AUTO/SELECT** button to automatically adjust your display image to the ideal setting.
If the results are unsatisfactory, decrease the vertical bars or stripes using the **CLOCK** icon in the on screen display.

- **Any horizontal noise appearing in any image or characters are not clearly portrayed.**
 - Press the **AUTO/SELECT** button to automatically adjust your display image to the ideal setting.
If the results are unsatisfactory, decrease the horizontal bars using the **PHASE** icon in the on screen display.
 - Check **Control Panel --> Display --> Settings** and adjust the display to the recommended resolution or adjust the display image to the ideal setting. Set the color setting higher than 24 bits (true color).

- **The screen color is mono or abnormal.**
 - Check if the signal cable is properly connected and use a screwdriver to fasten if necessary.
 - Make sure the video card is properly inserted in the slot.
 - Set the color setting higher than 24 bits (true color) at **Control Panel - Settings**.

- **The screen blinks.**
 - Check if the screen is set to interlace mode and if yes, change it to the recommend resolution.
 - Make sure the power voltage is high enough, It has to be hgher than **AC100-240V 50/60Hz**.

"IMAGE SIZE" function on OSD menu does not work.

● "IMAGE SIZE" function on OSD menu does not work?

- [L2300B]
Check if the resolution is set 1920x1200.
The optimal resolution is 1920x1200 and the image is fully displayed on the monitor and is not converted as 1:1 image size.
- [L2300C]
Check if the resolution is set 1360 x768.
The optimal resolution is 1360 x768 and the image is fully displayed on the monitor and is not converted as 1:1 image size.

Have you installed the display driver?

● Have you installed the display driver?

- Be sure to install the display driver from the display driver CD (or diskette) that comes with your display. Or, you can also download the driver from our web site: <http://www.lge.com>.

● Do you see an "Unrecognized monitor, Plug&Play (VESA DDC) monitor found" message?

- Make sure to check if the video card supports Plug&Play function.

Display	23 inches (58.4cm) Flat Panel Active matrix-TFT LCD Hard coating(3H), Anti-Glare 0.258 mm x 0.258mm	
Sync Input	Horizontal Freq.	D-Sub : 28 - 92kHz (Analog) DVI-D : 28 - 92kHz (Digital)
	Vertical Freq.	Analog :48 - 87Hz (Automatic) Digital : 57 - 63Hz (Automatic)
	Input Form	Separate TTL, Positive/Negative Composite TTL, Positive/Negative SOG (Sync On Green) Digital
Video Input	Signal Input	15 pin D-Sub Connector(Analog) DVI - D connector (Digital)
	Input Form	RGB Analog (0.7Vp-p/75ohm), Digital
Resolution	Max	D-SUB : Analog - VESA 1920 x 1200@60Hz DVI-D :Digital - VESA 1920 x 1200@60Hz
	Recommend	VESA 1920 x 1200@60Hz
Plug&Play	DDC 2B	
Power Consumption	Normal	: 80W
	Stand-by/Suspend	≤ 2W
	DPM Off	≤ 2W
	Soft Off	≤ 2W
Dimensions & Weight (with tilt/ swivel stand)	Width	57.9 cm / 22.79 inches
	Height	44.06 cm / 17.35 inches(Min) 52.06 cm / 20.49 inches(Max)
	Depth	23.81 cm / 9.37 inches
	Net	10.4 kg(22.92 lbs)
Tilt/Swivel Range	Tilt range	-5°~30°
	Swivel range	90°
	Height range	80mm / 3.15 inches
Power Input	AC 100-240V~ 50/60Hz 1.0A	
Environmental Conditions	Operating Conditions	
	Temperature	10°C to 35 °C
	Humidity	10 % to 80 % non-Condensing
	Storage Conditions	
Temperature	-20°C to 60 °C	
Humidity	5 % to 95 % non-Condensing	

Display	23 inches (582.96cm) Flat Panel Active matrix-TFT LCD Hard coating(3H), Anti-Glare 0.375 mm x 0.124mm x RGB	
Sync Input	Horizontal Freq.	D-Sub : 30 - 83kHz (Analog) DVI-D : 30 - 72kHz (Digital)
	Vertical Freq.	Analog : 56 - 85Hz (Automatic) Digital : 56 - 85Hz (Automatic)
	Input Form	Separate TTL, Positive/Negative Composite TTL, Positive/Negative SOG (Sync On Green) Digital
Video Input	Signal Input	15 pin D-Sub Connector(Analog) DVI - D connector (Digital)
	Input Form	RGB Analog (0.7Vp-p/75ohm), Digital
Resolution	Max	D-SUB : Analog - VESA 1600 x 1200@60Hz DVI-D : Digital - VESA 1360 x 768@60Hz
	Recommend	VESA 1360x 768@60Hz
Plug&Play	DDC 2B	
Power Consumption	Normal	: 90W
	Stand-by/Suspend	≤ 2W
	DPM Off	≤ 2W
	Soft Off	≤ 2W
Dimensions & Weight (with tilt/ swivel stand)	Width	57.9 cm / 22.79 inches
	Height	44.06 cm / 17.35 inches(Min) 52.06 cm / 20.49 inches(Max)
	Depth	23.81 cm / 9.37 inches
	Net	11.6 kg(25.57 lbs)
Tilt/Swivel Range	Tilt range	-5°~30°
	Swivel range	90°
	Height range	80mm / 3.15 inches
Power Input	AC 100-240V~ 50/60Hz 1.0A	
Environmental Conditions	Operating Conditions	
	Temperature	10°C to 35 °C
	Humidity	10 % to 80 % non-Condensing
	Storage Conditions	
Temperature	-20°C to 60 °C	
Humidity	5 % to 95 % non-Condensing	

Specifications

Tilt/Swivel Stand	Attached(O), Detached ()
Signal cable	Attached(O), Detached ()
Power cord	Wall-outlet type or PC-outlet type

NOTE

- Information in this document is subject to change without notice.

Preset Modes (Resolution)

● 2300B monitor

Display Modes (Resolution)		Horizontal Freq. (kHz)	Vertical Freq. (Hz)
1	640 x 480	31.47	60
2	800 x 600	37.88	60
3	1024 x 768	48.36	60
4	1280 x 1024	63.98	60.02
5	1600 x 1200	75.00	60
6	1920 x 1200	74.04	60
7	1152 x 900	61.80	65.96
8	640 x 350	31.47	70
9	720 x 400	31.47	70
10	640 x 480	37.50	75
11	800 x 600	46.88	75
12	832 x 624	49.72	75
13	1024 x 768	60.12	75
14	1152 x 870	68.68	75
15	1280 x 1024	79.98	75.02
16	640 x 480	43.27	85
17	800 x 600	53.67	85
18	1024 x 768	68.68	85

● D-Sub : Mode 1 ~ Mode 18

● DVI-D : Mode 1 ~ Mode 6

● 2300C monitor

Display Modes (Resolution)		Horizontal Freq. (kHz)	Vertical Freq. (Hz)
1	640 x 350	31.47	70
2	720 x 400	31.47	70
3	640 x 480	31.47	60
4	640 x 480	37.50	75
5	640 x 480	43.27	85
6	800 x 600	37.88	60
7	800 x 600	46.88	75
8	800 x 600	53.67	85
9	832 x 624	49.73	75
10	1024 x 768	48.36	60
11	1024 x 768	60.12	75
12	1024 x 768	68.68	85
13	1280 x 720	44.78	60
14	1360 x 768	47.72	60
15	1280 x 1024	63.98	60
16	1280 x 1024	79.98	75
17	1600 x 1200	75.00	60

● D-Sub : Mode 1 ~ Mode 17

● DVI-D : Mode 1 ~ Mode 14

Indicator

MODE	LED Color
Normal	green
Stand-by/Suspend	amber
DPMS Off	amber

VESA wall mounting

Connected to another object (stand type and wall-mounted type). This monitor accepts a VESA-compliant mounting interface pad. - **optional**
For further information, refer to the VESA Wall Mounting Instruction Guide.



Kensington Security Slot- optional

Connected to a locking cable that can be purchased separately at most computer stores

Signal Connector Pin Assignment

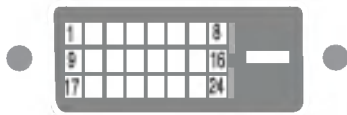

■ DVI-D Connector

Pin	Signal(DVI-D)	Pin	Signal(DVI-D)
1	T. M. D. S. Data2-	16	Hot Plug Detect
2	T. M. D. S. Data2+	17	T. M. D. S. Data0-
3	T. M. D. S. Data2/4 Shield	18	T. M. D. S. Data0+
4	T. M. D. S. Data4-	19	T. M. D. S. Data0/5 Shield
5	T. M. D. S. Data4+	20	T. M. D. S. Data5-
6	DDC Clock	21	T. M. D. S. Data5+
7	DDC Data	22	T. M. D. S. Clock Shield
8	Analog Vertical Sync.	23	T. M. D. S. Clock+
9	T. M. D. S. Data1-	24	T. M. D. S. Clock-
10	T. M. D. S. Data1+		
11	T. M. D. S. Data1/3 Shield		
12	T. M. D. S. Data3-		
13	T. M. D. S. Data3+		
14	+5V Power		
15	Ground (return for +5V, H. Sync. and V. Sync.)		

T. M. D. S. (Transition Minimized Differential Signaling)

Digitally yours ■■■■.....

