

User's Guide

L1770HQ
L1970HQ
L1970HR

Make sure to read the **Important Precautions** before using the product.

Keep the User's Guide(CD) in an accessible place for future reference.

See the label attached on the product and quote this information to your dealer when you require service.

This unit has been engineered and manufactured to ensure your personal safety, however improper use may result in potential electrical shock or fire hazards. In order to allow the proper operation of all safeguards incorporated in this display, observe the following basic rules for its installation, use, and servicing.

On Safety

Use only the power cord supplied with the unit. In case you use another power cord, make sure that it is certified by the applicable national standards if not being provided by the supplier. If the power cable is faulty in any way, please contact the manufacturer or the nearest authorized repair service provider for a replacement.

The power supply cord is used as the main disconnection device. Ensure that the socket-outlet is easily accessible after installation.

Operate the display only from a power source indicated in the specifications of this manual or listed on the display. If you are not sure what type of power supply you have in your home, consult with your dealer.

Overloaded AC outlets and extension cords are dangerous. So are frayed power cords and broken plugs. They may result in a shock or fire hazard. Call your service technician for replacement.

Do not Open the Display.

- There are no user serviceable components inside.
- There are Dangerous High Voltages inside, even when the power is OFF.
- Contact your dealer if the display is not operating properly.

To Avoid Personal Injury :

- Do not place the display on a sloping shelf unless properly secured.
- Use only a stand recommended by the manufacturer.

To Prevent Fire or Hazards:

- Always turn the display OFF if you leave the room for more than a short period of time. Never leave the display ON when leaving the house.
- Keep children from dropping or pushing objects into the display's cabinet openings. Some internal parts carry hazardous voltages.
- Do not add accessories that have not been designed for this display.
- During a lightning storm or when the display is to be left unattended for an extended period of time, unplug it from the wall outlet.

On Installation

Do not allow anything to rest upon or roll over the power cord, and do not place the display where the power cord is subject to damage.

Do not use this display near water such as near a bathtub, washbowl, kitchen sink, laundry tub, in a wet basement, or near a swimming pool.

Displays are provided with ventilation openings in the cabinet to allow the release of heat generated during operation. If these openings are blocked, built-up heat can cause failures which may result in a fire hazard. Therefore, NEVER:

- Block the bottom ventilation slots by placing the display on a bed, sofa, rug, etc.
- Place the display in a built-in enclosure unless proper ventilation is provided.
- Cover the openings with cloth or other material.
- Place the display near or over a radiator or heat source.

Do not rub or strike the Active Matrix LCD with anything hard as this may scratch, mar, or damage the Active Matrix LCD permanently.

Do not press the LCD screen with your finger for a long time as this may cause some afterimages.

Some dot defects may appear as Red, Green or Blue spots on the screen. However, this will have no impact or effect on the display performance.

If possible, use the recommended resolution to obtain the best image quality for your LCD display. If used under any mode except the recommended resolution, some scaled or processed images may appear on the screen. However, this is characteristic of the fixed-resolution LCD panel.

On Cleaning

- Unplug the display before cleaning the face of the display screen.
- Use a slightly damp (not wet) cloth. Do not use an aerosol directly on the display screen because over-spraying may cause electrical shock.

On Repacking

- Do not throw away the carton and packing materials. They make an ideal container in which to transport the unit. When shipping the unit to another location, repack it in its original material.

On Disposal

- The fluorescent lamp used in this product contains a small amount of mercury.
- Do not dispose of this product with general household waste.
Disposal of this product must be carried out in accordance to the regulations of your local authority.

- Before setting up the monitor, ensure that the power to the monitor, the computer system, and other attached devices is turned off.
- For the desktop monitor, install the computer with the stand unfolded, for ARM(wall mounting), install the computer with the stand folded.

Unfolding the stand base

1. Place the monitor with its front facing downward on a cushion or soft cloth.
2. Press the downside of the stand base with your left hand as shown in the picture.

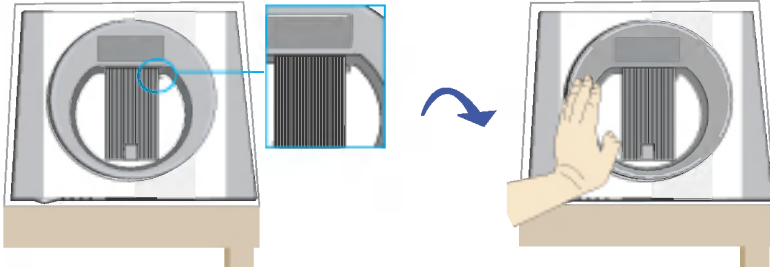

3. With your left hand pressing the stand base, press the folding button using your right hand.
4. To release the folding, relieve the pressure on the left hand slowly with your right hand still pressing the folding button.

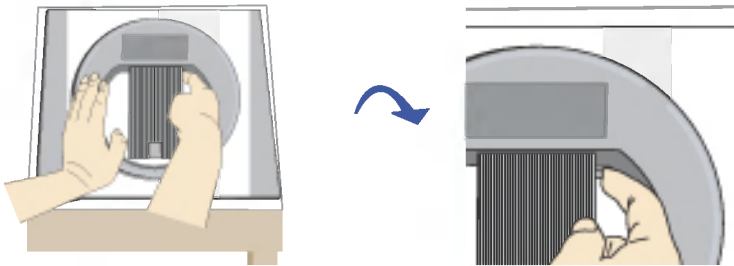

5. A spring is clicked on and the stand is brought out by itself from the standbase as shown in the picture.
6. Pull out the stand as shown in the picture and the stand will hold up.

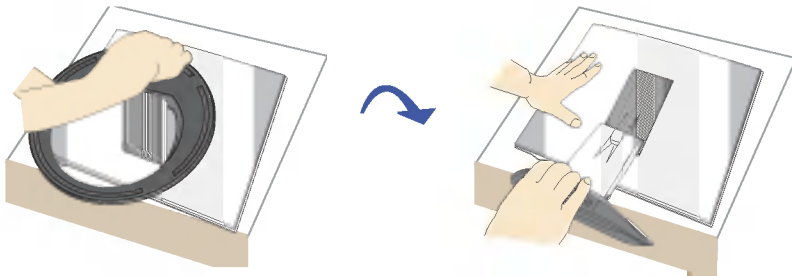

Folding the stand base

1. Face the front of the monitor and push the monitor backwards, following the sequence shown in the picture.

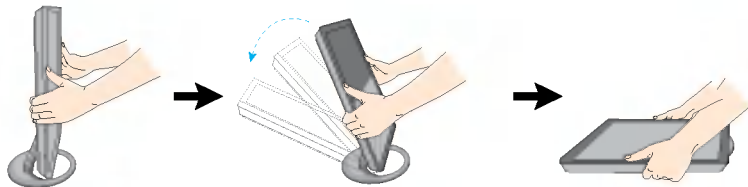

This illustration depicts the general model of connection. Your monitor may differ from the items shown in the picture.



Do not touch or apply force to the monitor screen while expanding or folding the stand base.

Positioning your display

1. Adjust the position of the panel in various ways for maximum comfort.
 - Tilt Range :0°~30
2. The direction of the arrow indicates the direction to fold the product. It does not indicate the degree of the usage.

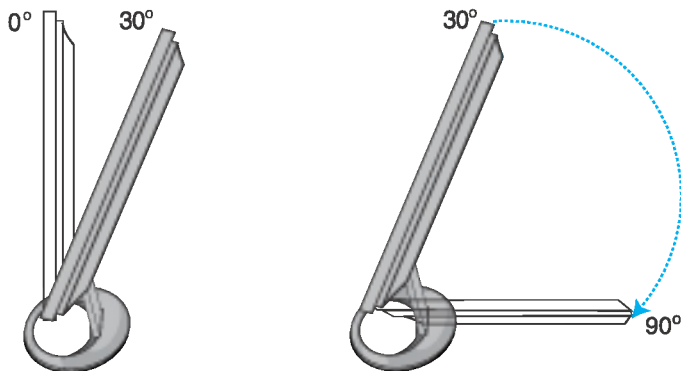



Ergonomic

It is recommended that in order to maintain an ergonomic and comfortable viewing position, the forward tilt angle of the monitor should not exceed 5 degrees.

Using the Computer

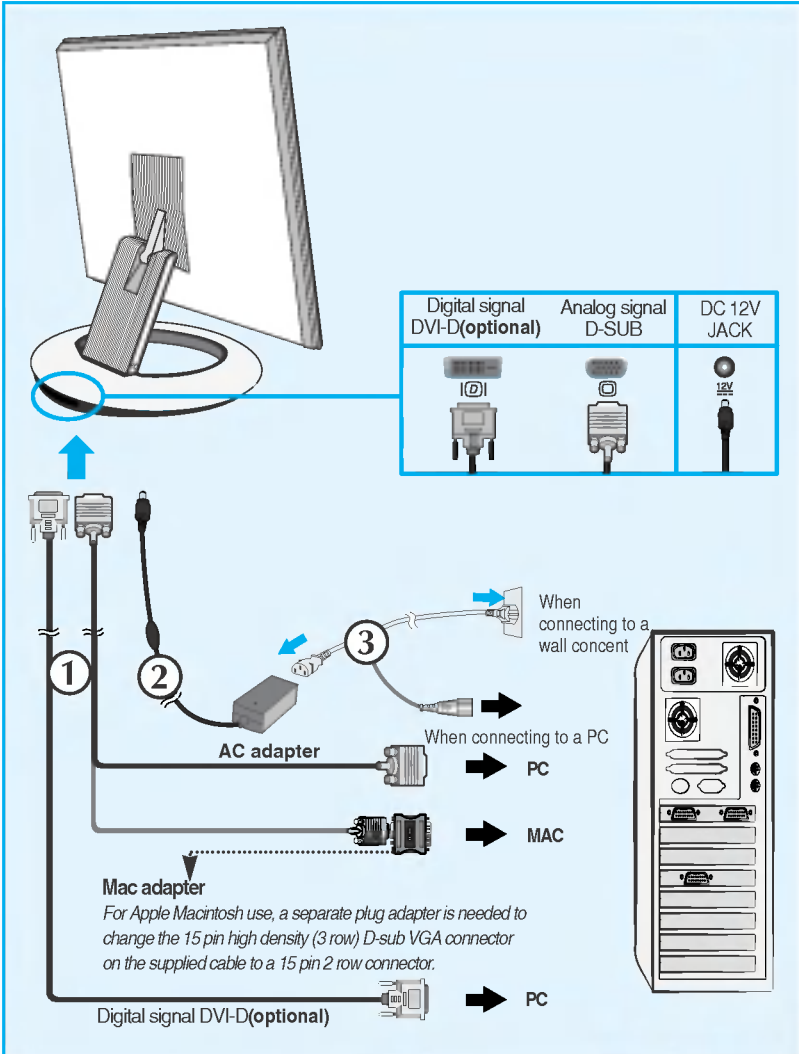
1. Connect the signal cable. When attached, tighten the thumbscrews to secure the connection. ①
2. Connect the power cable with the AC adapter (AC power supply) ②, and then plug the cable in the outlet. ③ (Voltage will be automatically controlled.)



3. Touch  button on the front switch panel to turn the power on. When monitor power is turned on, the '**Self Image Setting Function**' is executed automatically.(Only Analog Mode)



NOTE



'**Self Image Setting Function**'? This function provides the user with optimal display settings. When the user connects the monitor for the first time, this function automatically adjusts the display to optimal settings for individual input signals. If you want to adjust the monitor while in use, or wish to manually run this function once again, touch the 'AUTO/SET' button on the front panel of the monitor. Otherwise, you may execute the 'FACTORY RESET' option on the OSD adjustment menu. However, be aware that this option initializes all the menu items except 'LANGUAGE'.

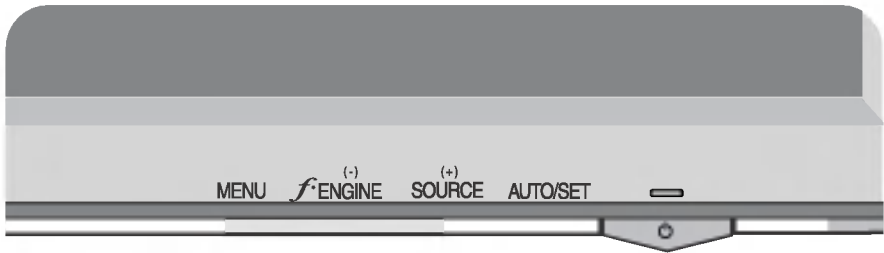

Front Panel Controls

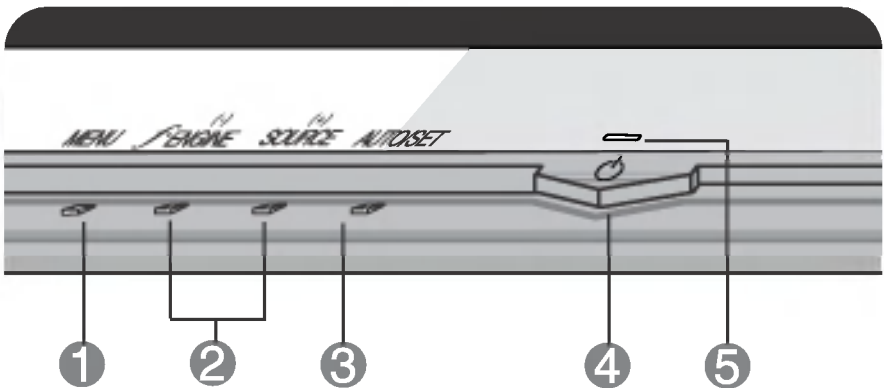

Bottom



Control	Function
1 MENU Button	Use this button to enter or exit the On Screen Display.
	OSD LOCKED/UNLOCKED This function allows you to lock the current control settings, so that they cannot be inadvertently changed. Touch and hold the MENU button for serval seconds. The message " OSD LOCKED " should appear. You can unlock the OSD controls at any time by touching the MENU button for serva seconds. The message " OSD UNLOCKED " should appear.
	

Control	Function
<p>2 - + Buttons</p> <hr/> <p>- Button</p>  <p>+ Button</p>	<p>Use these buttons to select or adjust functions in the On Screen Display.</p> <p>f-ENGINE hot key</p> <p>For more information, refer to page A14</p> <p>SOURCE hot key</p> <p>Use this button to make Dsub or DVI connector active. This feature is used when two computers are connected to the display. The default setting is Dsub.</p>
<p>3 AUTO/SET Button</p> 	<p>Use this button to enter a selection in the On Screen Display.</p> <p>AUTO IMAGE ADJUSTMENT</p> <p>When adjusting your display settings, always touch the AUTO/SET button before entering the On Screen Display(OSD). This will automatically adjust your display image to the ideal settings for the current screen resolution size (display mode).</p> <p>The best display mode is</p> <p>17 inch monitor : 1280x1024 19 inch monitor : 1280x1024</p>
<p>4 Power Button</p>	<p>Use this button to turn the display on or off.</p>
<p>5 Power Indicator</p>	<p>This Indicator lights up blue when the display operates normally(On Mode). If the display is in Sleep Mode (Energy Saving), this indicator color changes to amber.</p>

Screen Adjustment

Making adjustments to the image size, position and operating parameters of the display is quick and easy with the On Screen Display Control system. A short example is given below to familiarize you with the use of the controls. The following section is an outline of the available adjustments and selections you can make using the OSD.

NOTE

- Allow the display to stabilize for at least 30 minutes before making image adjustments.

To make adjustments in the On Screen Display, follow these steps:

MENU → - + → AUTO/SET → - + → MENU

- 1** Touch the **MENU Button**, then the main menu of the OSD appears.
- 2** To access a control, use the **- or + Buttons**. When the icon you want becomes highlighted, touch the **AUTO/SET Button**.
- 3** Use the **- / + Buttons** to adjust the image to the desired level. Use the **AUTO/SET Button** to select other sub-menu items.
- 4** Touch the **MENU Button** once to return to the main menu to select another function. Touch the **MENU Button** twice to exit from the OSD.

Automatic save

With the OSD open, once you have made an adjustment the monitor automatically save any adjustments you have made, even if you exit the menu or open another menu. If you make an adjustment and then wait for the OSD to disappear, the adjustment will also be saved.

The following table indicates all the On Screen Display control, adjustment, and setting menus.

Main menu	Sub-menu		A	D	Reference
PICTURE	BRIGHTNESS		●	●	To adjust the brightness, contrast and gamma of the screen
	CONTRAST		●	●	
	GAMMA		●	●	
COLOR	PRESET	6500K	●	●	To customize the color of the screen
		9300K	●	●	
	RED		●	●	
	GREEN		●	●	
	BLUE		●	●	
POSITION	HORIZONTAL		●		To adjust the position of the screen
	VERTICAL		●		
TRACKING	CLOCK		●		To improve the clarity and stability of the screen
	PHASE		●		
SETUP	LANGUAGE		●	●	To customize the screen status for a user's operating environment
	OSD POSITION	HORIZONTAL	●	●	
		VERTICAL	●	●	
	WHITE BALANCE		●		
	POWER INDICATOR		●	●	
	FACTORY RESET		●	●	
FLATRON F-ENGINE(-)	MOVIE/TEXT		●	●	To select or customize desired image settings
	USER		●	●	
	NORMAL		●	●	
<p>● : Adjustable A : Analog Input D : Digital Input</p>					

NOTE

- The order of icons may differ depending on the model (A10~A14).

On Screen Display(OSD) Selection and Adjustment

You were introduced to the procedure of selecting and adjusting an item using the OSD system. Listed below are the icons, icon names, and icon descriptions of the all items shown on the Menu.

Touch the MENU Button, then the main menu of the OSD appears.

The screenshot shows the 'PICTURE' OSD menu. It features a vertical list of icons on the left: a yellow lightbulb, a sun, a monitor, a TV, and a gear. The main area displays three settings: 'BRIGHTNESS' with a yellow slider at 50, 'CONTRAST' with a white slider at 50, and 'GAMMA' with a white slider at 0. At the bottom, there are four buttons: 'MENU' with a left arrow, a minus sign, a plus sign, and 'SET' with a right arrow. A 'Button Tip' box at the bottom explains these buttons: MENU (left arrow) for Exit, - + for Adjust (Decrease/Increase), SET (right arrow) for Enter, and a down arrow for Select another sub-menu. A bracket on the right side of the menu items is labeled 'Sub-menus'.

Menu Name — PICTURE

Icons —



Button Tip —





Sub-menus —



- MENU : Exit
- - + : Adjust (Decrease/Increase)
- SET : Enter
- : Select another sub-menu

NOTE





- OSD (On Screen Display) menu languages on the monitor may differ from the manual.

Main menu	Sub menu	Description
 PICTURE		
	BRIGHTNESS	To adjust the brightness of the screen.
	CONTRAST	To adjust the contrast of the screen.
	GAMMA	Set your own gamma value. : -50/0/50 On the monitor, high gamma values display whitish images and low gamma values display high contrast images.
<ul style="list-style-type: none"> ■ MENU : Exit ■ - : Decrease ■ + : Increase ■ SET : Select another sub-menu 		

 COLOR		
	PRESET	Select the screen color. • 6500K: Slightly reddish white. • 9300K: Slightly bluish white.
	 RED	Set your own red color levels.
	 GREEN	Set your own green color levels.
	 BLUE	Set your own blue color levels.
<ul style="list-style-type: none"> ■ MENU : Exit ■ - : Decrease ■ + : Increase ■ SET : Select another sub-menu 		

 POSITION		
	HORIZONTAL	To move image left and right.
	VERTICAL	To move image up and down.
<ul style="list-style-type: none"> ■ MENU : Exit ■ - : Decrease ■ + : Increase ■ SET : Select another sub-menu 		

On Screen Display(OSD) Selection and Adjustment

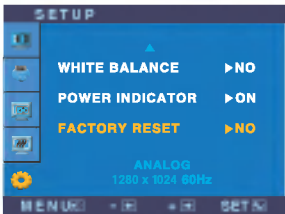
Main menu	Sub menu	Description
 TRACKING		
	CLOCK	To minimize any vertical bars or stripes visible on the screen background. The horizontal screen size will also change.
	PHASE	To adjust the focus of the display. This item allows you to remove any horizontal noise and clear or sharpen the image of characters.
<ul style="list-style-type: none">■ MENU : Exit■ - : Decrease■ + : Increase■ SET : Select another sub-menu		
 SETUP		
	LANGUAGE	To choose the language in which the control names are displayed.
	OSD POSITION	To adjust position of the OSD window on the screen.
	WHITE BALANCE	If the output of the video card is different the required specifications, the color level may deteriorate due to video signal distortion. Using this function, the signal level is adjusted to fit into the standard output level of the video card in order to provide the optimal image. Activate this function when white and black colors are present in the screen.
	POWER INDICATOR	Use this function to set the power indicator on the front side of the monitor to ON or OFF . If you set OFF , it will go off. If you set ON at any time, the power indicator will automatically be turned on.
	FACTORY RESET	Restore all factory default settings except "LANGUAGE." Press the + button to reset immediately.
<ul style="list-style-type: none">■ MENU : Exit■ - : Adjust■ + : Adjust■ SET : Select another sub-menu		

If this does not improve the screen image, restore the factory default settings.

If necessary, perform the white balance function again. This function will be enabled only when the input signal is an analog signal.

On Screen Display(OSD) Selection and Adjustment

- ■ ■ The OSD screen will appear when you touch the **F-ENGINE (-)** button at the front side of the monitor.



FLATRON F-ENGINE

When you execute F-ENGINE, two tones will appear on the screen as shown. The applied screen will appear on the left side, whereas the non-applied screen will appear on the right side. Touch the SET button to use the adjusted screen.

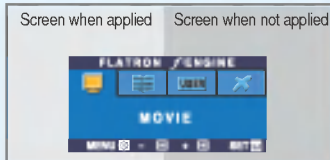

Main menu	Sub menu	Description
-----------	----------	-------------



MOVIE TEXT This feature lets you easily select the best desired image condition optimized to the environment (ambient illumination, image types etc).

MOVIE: For animation images in videos or movies

TEXT: For text images (Word processing etc.)



USER User

You can manually adjust brightness, ACE or RCM. You can save or restore the adjusted value even when using a different environment setting.

To adjust the USER sub-menu function, Press the SET Button

- ☀ (Brightness): Adjusts screen brightness.
- ...ACE(Adaptive Clarity Enhancer): Selects the clarity mode.
- ...RCM(Real Color Management): Selects the color mode.

- Not applied
- Green enhance
- Flesh tone
- Color Enhance



Select the **SAVE** sub-menu using the **SET button** and save the **YES** value using the **- buttons**.

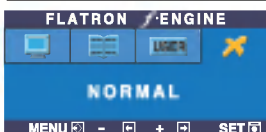

NORMAL This is under normal operating conditions.

Check the following before calling for service.

No image appears

- | | |
|------------------------------------------------------------------------------------------------------------------------------------------------------------------------------------------------------------------------------------------------------------------------------------------------------------------------------------------------------------------------------------------------------------------------------|---------------------------------------------------------------------------------------------------------------------------------------------------------------------------------------------------------------------------------------------------------------------------------------------------------------------------------------------------------------------------------------------------------------------------------------------------------------------------------------------------------------------------------------------------------------------------------------------------------------------------------------------------------------------------------------------------------------------------------------------------------------|
| <ul style="list-style-type: none">● Is the power cord of the display connected?● Is the power indicator light on?● Is the power on and the power indicator blue or green?● Is the power indicator amber?● Do you see an "OUT OF RANGE" message on the screen?● Do you see a "CHECK SIGNAL CABLE" message on the screen? | <ul style="list-style-type: none">• Check and see if the power cord is connected properly to the power outlet.• Press the Power button.• Adjust the brightness and the contrast.• If the display is in power saving mode, try moving the mouse or pressing any key on the keyboard to bring up the screen.• Try to turn on the PC.• This message appears when the signal from the PC (video card) is out of horizontal or vertical frequency range of the display. See the 'Specifications' section of this manual and configure your display again.• This message appears when the signal cable between your PC and your display is not connected. Check the signal cable and try again. |
|------------------------------------------------------------------------------------------------------------------------------------------------------------------------------------------------------------------------------------------------------------------------------------------------------------------------------------------------------------------------------------------------------------------------------|---------------------------------------------------------------------------------------------------------------------------------------------------------------------------------------------------------------------------------------------------------------------------------------------------------------------------------------------------------------------------------------------------------------------------------------------------------------------------------------------------------------------------------------------------------------------------------------------------------------------------------------------------------------------------------------------------------------------------------------------------------------|

Do you see a "OSD LOCKED" message on the screen?



- | | |
|--------------------------------------------------------------------------------------------------------------|--------------------------------------------------------------------------------------------------------------------------------------------------------------------------------------------------------------------------------------------------------------------------------------------------|
| <ul style="list-style-type: none">● Do you see "OSD LOCKED" when you touch MENU button? | <ul style="list-style-type: none">• You can secure the current control settings, so that they cannot be inadvertently changed. You can unlock the OSD controls at any time by pushing the MENU button for several seconds. The message "OSD UNLOCKED" should appear. |
|--------------------------------------------------------------------------------------------------------------|--------------------------------------------------------------------------------------------------------------------------------------------------------------------------------------------------------------------------------------------------------------------------------------------------|

Display image is incorrect

- | | |
|-----------------------------------------------------------------------------------------------------------------------------------------------------------------------------------------------------------------------------------------------------------------------------------------------------------------------------------------------------------------------------------------------|--------------------------------------------------------------------------------------------------------------------------------------------------------------------------------------------------------------------------------------------------------------------------------------------------------------------------------------------------------------------------------------------------------------------------------------------------------------------------------------------------------------------------------------------------------------------------------------------------------------------------------------------------------------------------------------------------------------------------------------------------------------------------------------------------------------------------------------------------------------------------------------------------------------------------------------------------------------------------------------------------------------------------------------------------------------------------------------------------------------------------------------------------------------------------------------------------------------------------------------------------------------------------------------------------------------------------------------------------------------------------------------------------------------------------------------------------------------------------------------------------------------------------------------------------------------------------------------------------------------------------------------------------------------------------------------------------------------------------------|
| <ul style="list-style-type: none">● Display Position is incorrect.
● On the screen background, vertical bars or stripes are visible.
● Any horizontal noise appearing in any image or characters are not clearly portrayed.
● The screen color is mono or abnormal.
● The screen blinks. | <ul style="list-style-type: none">• Press the AUTO/SET button to automatically adjust your display image to the ideal setting. If the results are unsatisfactory, adjust the image position using the H position and V position icon in the on screen display.• Check Control Panel --> Display --> Settings and see if the frequency or the resolution were changed. If yes, readjust the video card to the recommend resolution.
• Press the AUTO/SET button to automatically adjust your display image to the ideal setting. If the results are unsatisfactory, decrease the vertical bars or stripes using the CLOCK icon in the on screen display.
• Press the AUTO/SET button to automatically adjust your display image to the ideal setting. If the results are unsatisfactory, decrease the horizontal bars using the PHASE icon in the on screen display.• Check Control Panel --> Display --> Settings and adjust the display to the recommended resolution or adjust the display image to the ideal setting. Set the color setting higher than 24 bits (true color).
• Check if the signal cable is properly connected and use a screwdriver to fasten if necessary.• Make sure the video card is properly inserted in the slot.• Set the color setting higher than 24 bits (true color) at Control Panel - Settings.
• Check if the screen is set to interlace mode and if yes, change it to the recommend resolution.• Make sure the power voltage is high enough, It has to be higher than AC100-240V 50/60Hz. |
|-----------------------------------------------------------------------------------------------------------------------------------------------------------------------------------------------------------------------------------------------------------------------------------------------------------------------------------------------------------------------------------------------|--------------------------------------------------------------------------------------------------------------------------------------------------------------------------------------------------------------------------------------------------------------------------------------------------------------------------------------------------------------------------------------------------------------------------------------------------------------------------------------------------------------------------------------------------------------------------------------------------------------------------------------------------------------------------------------------------------------------------------------------------------------------------------------------------------------------------------------------------------------------------------------------------------------------------------------------------------------------------------------------------------------------------------------------------------------------------------------------------------------------------------------------------------------------------------------------------------------------------------------------------------------------------------------------------------------------------------------------------------------------------------------------------------------------------------------------------------------------------------------------------------------------------------------------------------------------------------------------------------------------------------------------------------------------------------------------------------------------------------|



Have you installed the display driver?

- | | |
|-------------------------------------------------------------------------------------------------------------------------------------------------------------------------------------------------------------|------------------------------------------------------------------------------------------------------------------------------------------------------------------------------------------------------------------------------------------------------------------------------------------------------------------------------------------------------------------|
| <ul style="list-style-type: none">● Have you installed the display driver?
● Do you see an "Unrecognized monitor, Plug&Play (VESA DDC) monitor found" message? | <ul style="list-style-type: none">• Be sure to install the display driver from the display driver CD (or diskette) that comes with your display. Or, you can also download the driver from our web site: http://www.lge.com.
• Make sure to check if the video card supports Plug&Play function. |
|-------------------------------------------------------------------------------------------------------------------------------------------------------------------------------------------------------------|------------------------------------------------------------------------------------------------------------------------------------------------------------------------------------------------------------------------------------------------------------------------------------------------------------------------------------------------------------------|

Display	17 inches (43.27cm) Flat Panel Active matrix-TFT LCD Anti-Glare coating 17 inches viewable 0.264mm pixel pitch	
Sync Input	Horizontal Freq.	30 - 83kHz (Analog) 30 - 71kHz (Digital)
	Vertical Freq.	56 - 75Hz (Automatic)
	Input Form	Separate TTL, Positive/Negative SOG (Sync On Green) Digital
Video Input	Signal Input	15 pin D-Sub Connector DVI - D connector
	Input Form	RGB Analog (0.7Vp-p/75ohm), Digital
Resolution	Max	DVI Digital: VESA 1280 x 1024@60Hz D-sub Analog: VESA 1280 x 1024@75Hz
	Recommend	VESA 1280 x 1024@60Hz
Plug&Play	DDC 2B	
Power Consumption	On Mode	: 35W
	Sleep Mode	≤ 1W
	Off Mode	≤ 1W
Dimensions & Weight (with tilt stand)	Full Up Position	Folded Position
		
	Width	36.95 cm / 14.55inches
	Height	37.74 cm / 14.86 inches
	Depth	23.65 cm / 9.31 inches
	Net	4.3 kg (9.48 lbs)
Tilt Range	Tilt	0°~30°
Power Input	12V = 3A	
AC/DC Adapter	DVE. DSA-0421S-12 1	
Environmental Conditions	Operating Conditions	
	Temperature	10°C to 35 °C
	Humidity	10 % to 80 % non-Condensing
	Storage Conditions	
	Temperature	-20°C to 60 °C
	Humidity	5 % to 90 % non-Condensing
Tilt Stand	Attached(O), Detachable ()	
Signal cable	Attached(), Detachable (O)	
Power cord	Wall-outlet type or PC-outlet type	

NOTE

- Information in this document is subject to change without notice.

Display	19 inches (48.19cm) Flat Panel Active matrix-TFT LCD Anti-Glare coating 19 inches viewable 0.294mm pixel pitch	
Sync Input	Horizontal Freq.	30 - 83kHz (Analog) 30 - 71kHz (Digital)
	Vertical Freq.	56 - 75Hz (Automatic)
	Input Form	Separate TTL, Positive/Negative SOG (Sync On Green) Digital
Video Input	Signal Input	15 pin D-Sub Connector DVI - D connector
	Input Form	RGB Analog (0.7Vp-p/75ohm), Digital
Resolution	Max	DVI Digital: VESA 1280 x 1024@60Hz D-sub Analog: VESA 1280 x 1024@75Hz
	Recommend	VESA 1280 x 1024@60Hz
Plug&Play	DDC 2B	
Power Consumption	On Mode	: 39W
	Sleep Mode	≤ 1W
	Off Mode	≤ 1W
Dimensions & Weight (with tilt stand)	Full Up Position	
		
	Width	41.23 cm / 16.23inches
	Height	41.4 cm / 16.29 inches
	Depth	23.65 cm / 9.31 inches
	Net	5.4 kg (11.91 lbs)
Folded Position		
		
Width	41.23 cm / 16.23inches	
Height	34.52cm / 13.59 inches	
Depth	6.3 cm / 2.48inches	
Tilt Range	Tilt	0°~30°
Power Input	12V = 3A	
AC/DC Adapter	DVE. DSA-0421S-12 1	
Environmental Conditions	Operating Conditions	
	Temperature	10°C to 35 °C
	Humidity	10 % to 80 % non-Condensing
	Storage Conditions	
Temperature	-20°C to 60 °C	
Humidity	5 % to 90 % non-Condensing	
Tilt Stand	Attached(O), Detachable ()	
Signal cable	Attached(), Detachable (O)	
Power cord	Wall-outlet type or PC-outlet type	

NOTE

Information in this document is subject to change without notice.

Preset Modes (Resolution)

Display Modes (Resolution)		Horizontal Freq. (kHz)	Vertical Freq. (Hz)
1	VGA 640 x 350	31.469	70
2	VGA 720 x 400	31.468	70
3	VGA 640 x 480	31.469	60
4	VESA 640 x 480	37.500	75
5	VESA 800 x 600	37.879	60
6	VESA 800 x 600	46.875	75
7	MAC 832 x 624	49.725	75
8	VESA 1024 x 768	48.363	60
9	VESA 1024 x 768	60.023	75
10	MAC 1152 x 870	68.681	75
11	VESA 1152 x 900	61.805	65
*12	VESA 1280 x 1024	63.981	60
**13	VESA 1280 x 1024	79.976	75

* Recommend Mode

** Only Analog Mode

Indicator

MODE	LED Color
On Mode	blue
Sleep Mode	amber
Off Mode	Off

How to Install the VESA Standard wall mounting

This monitor meets VESA-compliant mounting interface pad specifications.

1

- Face the front of the monitor and push the monitor backwards, following the sequence shown in the picture.
- Put the monitor on a soft cloth or cushion with its front facing downward.

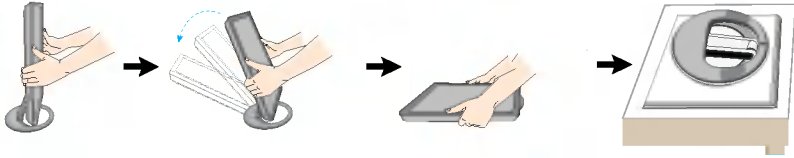

2

- Turn the 4 screws tight to the end of the standbase.

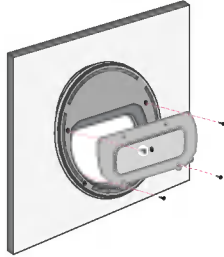

3

- Install the VESA standrad wall mounting.

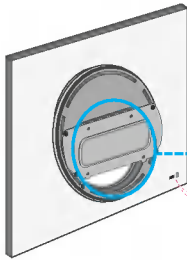

Kensington Security Slot
Connected to a locking cable that can be purchased separately at most computer stores



VESA wall mounting
Connected to another object (stand type and wall-mounted type). This monitor accepts a VESA-compliant mounting interface pad. - **optional**
For further information, refer to the VESA Wall Mounting Instruction Guide.

