



CAR CD/MP3/WMA Receiver

OWNER'S MANUAL

MODEL : LAC-M5600

Please read this instruction booklet carefully and completely before connecting, operating or adjusting this product.



USB





Safety note

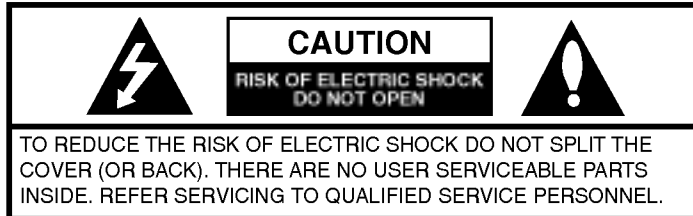

The lightning flash with arrowhead symbol, within an equilateral triangle is intended to alert the user about the presence of uninsulated dangerous voltage within the product's enclosure that may be of sufficient magnitude to constitute a risk of electric shock to persons.



The exclamation point within an equilateral triangle is intended to alert the user to the presence of important operating and maintenance (servicing) instructions in the literature accompanying the appliance.



Always operate the vehicle in a safe manner. Do not become distracted by the vehicle while driving, and always be fully aware of all driving condition. Do not change settings, or any functions. Pull over in a safe and legal manner before attempting such operations.



Do not use for many hours at extremely low or high temperatures. (-10~60°C)



To reduce the risk of electric shock, do not remove the cover or back of this product. There are no user-serviceable parts inside. Refer servicing to qualified service personnel.



To reduce the risk of fire or electric shock, do not expose this product to dripping or splashing water, rain, or moisture.



The temperature of units outside can be extremely high, please use the unit after proper installation in your vehicle.

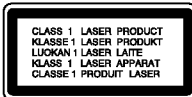

CAUTION : VISIBLE AND INVISIBLE LASER RADIATION WHEN OPEN AND INTERLOCKS DEFEATED.

CAUTION : This product uses a Laser System.

To ensure proper use of this product, please read this owner's manual carefully and retain it for future reference. Should the unit require maintenance, contact an authorized service center.

Performing controls, adjustments, or carrying out procedures other than those specified herein may result in hazardous radiation exposure.

To prevent direct exposure to laser beam, do not try to open the enclosure.

Visible laser radiation when open. DO NOT STARE INTO BEAM.

Safety note / Table of contents



- A defective or soiled disc inserted into the unit can cause the sound to drop during playback.
- Handle the disc by holding its inner and outer edges.
- Do not touch the surface of the unlabeled side of the disc.



Do not stick paper or tape, etc. on the surface.



Do not expose the disc to direct sunlight or excessive heat.



8 cm discs cannot be used in this unit, (use 12cm discs only).



- Clean the disc before playback. Wipe the disc from the center outward with a cleaning cloth.
- Never use solvents such as benzine or alcohol to clean the disc.

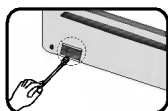

Periodically wipe the contacts on the back of the front panel with a cotton swab moistened with alcohol.

Safety note	2-3
Table of contents	3
Before use	4
Front panel	5
Remote control	6
Installation	7
Connection diagram	8
Connection	9
Basic operation	10-12
USB operation	13
Radio operation	14
CD/MP3/WMA operation	15-16
Troubleshooting	17
Specifications	18



Before use

Detachable front panel

The front panel can be detached to prevent theft.

- 1 Press  (RELEASE) to open the front panel.
- 2 Hold the right part the front panel.
- 3 Pull the front panel.
- 4 Place the front panel in the supplied protective case.

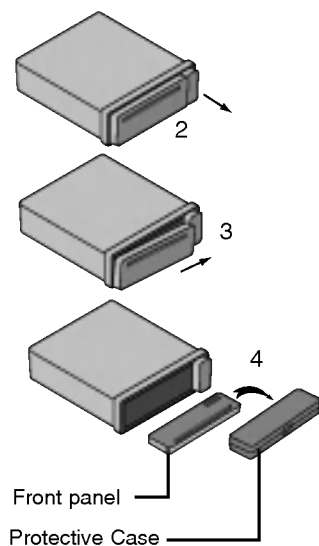

Attachable front panel

The front panel can be detached to prevent theft.

- 1 Align the left side of the panel with the stopper.
- 2 Push the right side of panel into the unit until it clicks.

Notes

- When detaching or attaching the front panel, do not press the display or control buttons.
- The control buttons may not work properly if the front panel is not attached properly. If this occurs, gently press the front panel.
- Do not leave the front panel in any area exposed to high temperatures or direct sunlight.
- Do not drop the front panel or otherwise subject it to a strong impact.
- Do not allow volatile agents such as benzine, thinner, or insecticides to come into contact with the surface of the front panel.
- Do not try to disassemble the front panel.

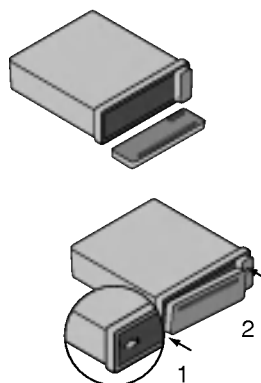

Front Panel

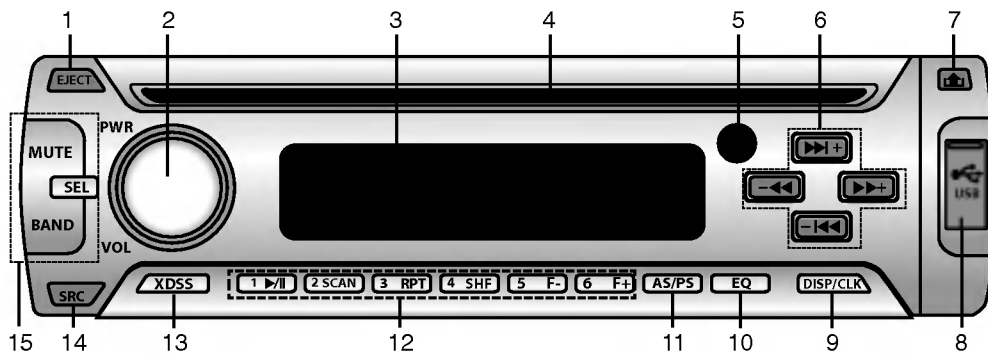

- | | |
|--|--|
| <ul style="list-style-type: none"> 1 [EJECT] 2 POWER / VOLUME [PWR/VOL] 3 DISPLAY WINDOW 4 DISC SLOT 5 REMOTE SENSOR 6 • SKIP ◀◀/▶▶ / SEEK • SEARCH ◀▶/▶▶ / TUNE -/+ 7 RELEASE ⏏ 8 USB Port [USB] 9 DISPLAY / CLOCK [DISP / CLK] 10 EQUALIZER [EQ] 11 • AUTO STORE [AS] • PRESET SCAN [PS] | <ul style="list-style-type: none"> 12 • PRESET STATION [1-6] • MP3 TRACK +10/-10 MP3 WMA • FOLDER UP/DOWN [F+/F-] MP3 WMA • SHUFFLE [SHF] • REPEAT [RPT] • INTRO SCAN [SCAN] • PLAY/PAUSE ▶/ 13 Extreme Dynamic Sound System [XDSS] 14 SOURCE [SRC] 15 • [MUTE] • SELECT [SEL] • [BAND] |
|--|--|



Remote control

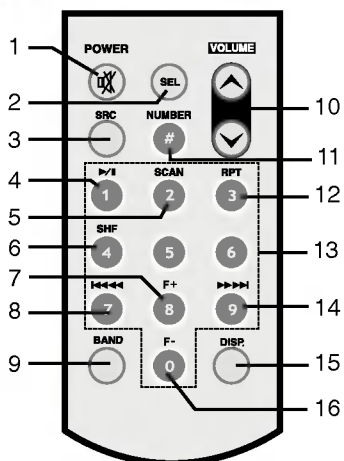

- 1 POWER [PWR] / MUTE
- 2 SELECTION [SEL]
- 3 SOURCE [SRC]
- 4 PLAY / PAUSE
- 5 INTRO SCAN [SCAN]
- 6 SHUFFLE [SHF]
- 7 • MP3 TRACK +10
- 8 • CD SKIP / SEARCH
- 9 [BAND]
- 10 VOLUME UP / DOWN
- 11 NUMBER [#]
- 12 REPEAT [RPT]
- 13 NUMBER [0 -9]
- 14 • CD SKIP / SEARCH
- 15 DISPLAY [DISP.]
- 16 • MP3 TRACK -10 • FOLDER DOWN [F-]

Battery installation

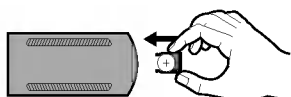
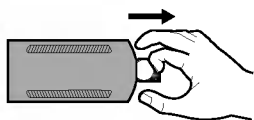
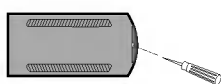

- 1 Remove the battery holder with a pencil or ball point pen.
- 2 Install the battery on the battery holder.
- 3 Install the battery holder back into its original position.

✦ Notes

- Use only one CR2025 (3V) lithium battery.
- Remove the battery if the remote control is not used for a long period of time.
- Do not leave the product in a hot or humid place.
- Do not handle the battery using metallic tools.
- Do not store the battery together with metallic materials.
- In the event of battery leakage, wipe the remote control completely clean and install a new battery.

Installation

Basic Installation

Before installing, make sure that the ignition switch is set to OFF and remove the terminal of the car battery to avoid short-circuiting.

- 1 Remove the existing receiver unit.
- 2 Make the necessary connections.
- 3 Install the installation sleeve.
- 4 Install the unit into the installation sleeve.

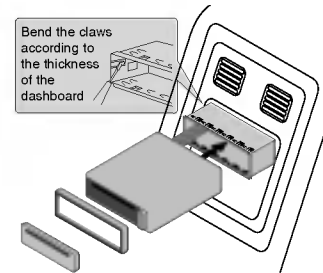

Front panel

Removing the existing receiver unit.

Please remove any installation sleeves already in place for the receiver unit in the dashboard, it must be removed.

- 1 Remove the rear support from the unit.
- 2 Remove the front panel and trim ring from the unit.
- 3 Insert the lever **A** into the hole on one side of the unit. Perform the same operation on the other side and pull the unit out from the mounting sleeve.

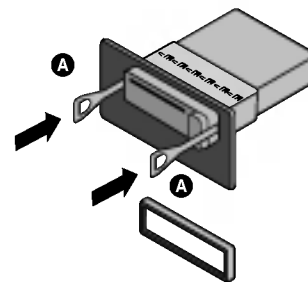

ISO-DIN Installation

- 1 Slide the unit into the ISO-DIN frame.
- 2 Install the screws removed from the old unit.
- 3 Slide the unit and frame into the dash opening.
- 4 Install the dash panel or adapter plate.
- 5 Install the trim ring into unit.
- 6 Install the faceplate by fitting the right edge into position then pushing the left edge closed.

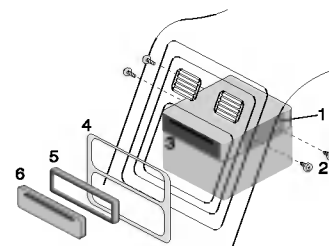

Front panel



Connection diagram

Before connecting, make sure that the ignition switch is set to OFF, and remove the battery ⊖ terminal to avoid short circuits.

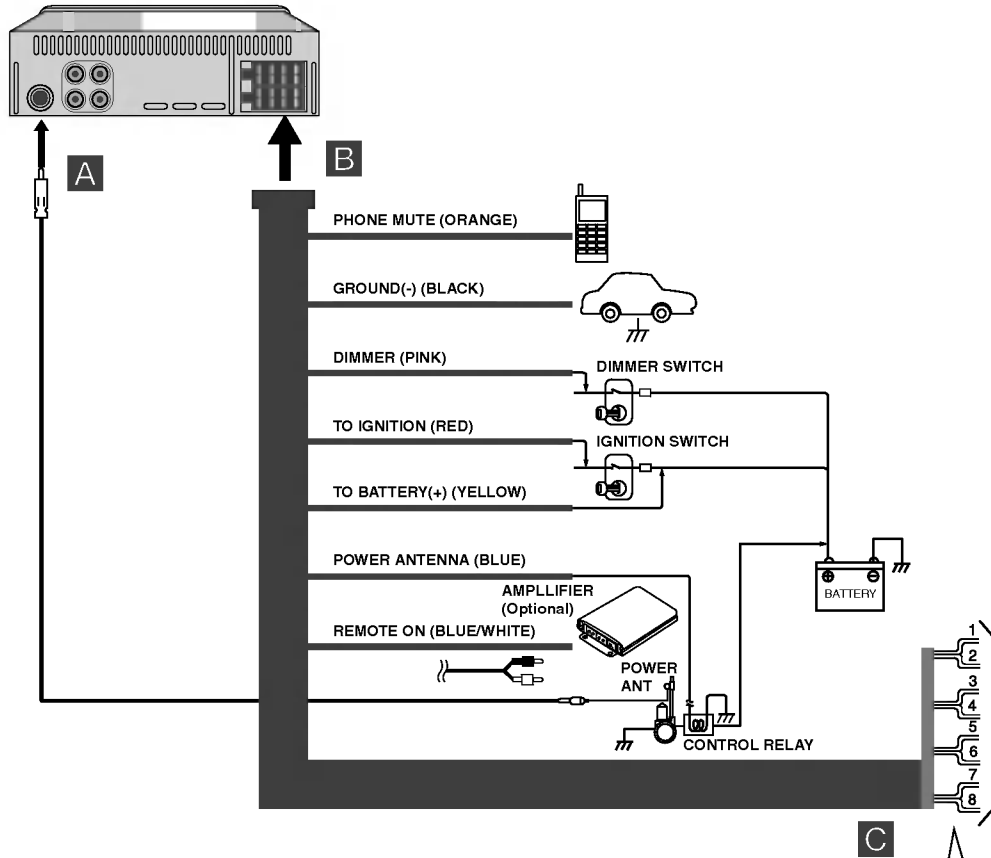

1. WHITE FL+
2. WHITE/BLACK STRIPE FL-
3. GRAY FR+
4. GRAY/ BLACK STRIPE FR-
5. GREEN RL+
6. GREEN/ BLACK STRIPE RL-
7. VIOLET RR+
8. VIOLET/ BLACK STRIPE RR-

Connection

A From antenna

B To the wiring of the vehicle colors of leads.

- **BLACK** : This lead is for the ground connection.
- **ORANGE** : This lead is for the phone line connection.
- **PINK** : This lead is for the dimmer line connection.
- **RED** : This lead is for connection to the power supply terminal when the ignition switch is set to ACC.
- **YELLOW** : This lead is for connection to the battery (back-up) terminal from which power is always supplied.
- **BLUE** : This lead is for the power antenna connection.
- **BLUE/WHITE** : This lead is for the remote amplifier on connection.

C Speaker Connections

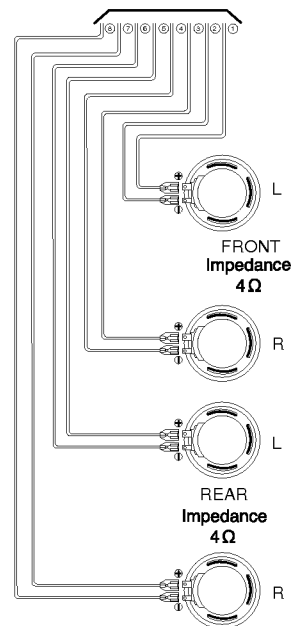

Connecting to Auxiliary Equipment (Optional)

Connect the **AUDIO OUTPUT** connector of this unit to the **AUDIO INPUT** connector of the Auxiliary Equipment.

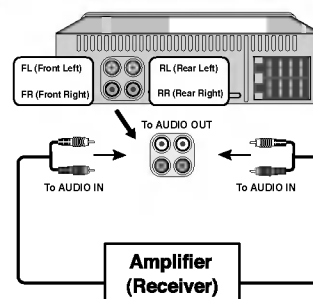



Basic operation

Turning the unit on

Press **PWR/VOL** (**POWER/MUTE**  on the remote control) or any other button.

Note

When you insert the CD in the CD slot, the unit turns on.

Turning the unit off

Press **PWR/VOL**. (**POWER/MUTE**  on the remote control for more than 1.2 seconds.)

Insert a disc

- 1 Press the **EJECT**.
- 2 The disc is drawn in and playback starts automatically.

Eject a disc

Press the **EJECT**. The disc automatically ejects from the loading slot.

When the disc is ejected by pressing **EJECT** during playback, it will be loaded automatically after 10 seconds unless you pull out the disc from the unit.

Selecting a source

Press **SRC** repeatedly to select a source.

The indicator lights up in the following order: Tuner → CD → Tuner...

Adjusting the volume

Rotate **PWR/VOL** (Or press **VOLUME ▲ ▼** on the remote control) to adjust the sound level.

Note

When you turn the unit off, the current volume level is automatically memorized. Whenever you turn the unit back on, it will operate at the memorized volume level.

Setting the clock

- 1 Press **DISP/CLK** and by press and hold for more than 1 second.
- 2 Press **▶▶I** to adjust the hour.
- 3 Press **I◀◀** to adjust the minute.



Checking the clock

You can see the clock pressing **DISP/CLK** (**DISP.** on the remote control).

Basic operation



Mute

- 1 Press **MUTE** (**POWER/MUTE**  on the remote control) to cut the sound.
- 2 To cancel it, press **MUTE** (**POWER/MUTE**  on the remote control) again.

Adjusting the beep sound

- 1 Press **SEL** for more than 2 seconds.
"BEEP ALL" or "BEEP 2ND" appear.
- 2 Rotate **PWR/VOL** (Or press **VOLUME ▲ ▼** on the remote control) to select the beep sounds.
BEEP ALL : When any button is pressed, beep sounds.
BEEP 2ND : When a key is long pressed (1sec), beep sounds.

Using the EQ (Equalizer)

The equalizer lets you adjust the equalization to match the acoustic characteristics of the car's interiors design.

Press **EQ** repeatedly.

The indicator lights up in the following order.

POP → CLASSIC → ROCK → JAZZ → VOCAL → SALSA → SAMBA → USER1 → USER2 → EQ off (No display)

- **POP** : Optimized for R&B, Soul and Country music.
- **CLASSIC** : Optimized for orchestral music.
- **ROCK** : Optimized for Hard Rock and Heavy Metal music.
- **JAZZ** : Sweet sound with soft feeling.
- **VOCAL** : Powerful realism with strong sound quality.
- **SALSA** : Reproduces salsa music acoustics.
- **SAMBA** : Reproduces samba music acoustics.
- **USER1** : Use the menu to set the sound level you want.
- **USER2** : Use the menu to set the sound level you want.

XDSS (Extreme Dynamic Sound System)

Press and hold the **XDSS** to reinforce treble, bass and surround effect.

XDSS off (No display) → XDSS



Basic operation

Using the User1/User2 (Sound level)

- 1 Press **SEL** repeatedly to select the mode you want to adjust from volume, bass, middle, treble, balance and fader.
The indicator lights up in the following order.
VOL → BAS → MID → TRB → BAL → FAD
- 2 Rotate **PWR/VOL** (Or press **VOLUME ▲ ▼** on the remote control) to adjust the sound quality.

	Turn right	Turn left
<i>VOL</i>	Increase the volume level.	Decrease the volume level.
<i>BAS</i>	Increase the bass level.	Decrease the bass level.
<i>MID</i>	Increase the middle level.	Decrease the middle level.
<i>TRB</i>	Increase the treble level.	Decrease the treble level.
<i>BAL</i>	Decrease the level of the left speaker(s).	Decrease the level of the right speaker(s).
<i>FAD</i>	Decrease the level of the front speaker(s).	Decrease the level of the rear speaker(s).

Note

The unit can adjust the bass, middle and treble in the **User1**, **User2**, **EQ OFF** or **XDSS OFF**.

USB operation

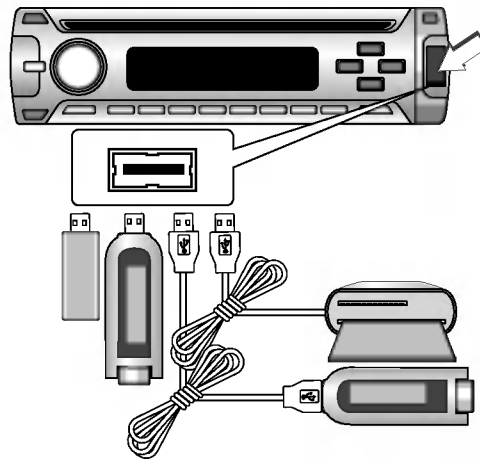

If the plug length of USB device is under 10mm, the USB device may not be correctly inserted or the connection failure may occur.

Playing a USB device

- 1 Plug the USB device into the USB port of your unit.
- 2 Press **SRC** repeatedly to select a USB.
The indicator lights up in the following order:
TUNER → CD → USB → TUNER...
If a USB device has been connected, USB is selected automatically.
The way to use the files recorded in a USB memory device is the same as when using a DISC.

Moving to another DRIVER

When connecting this unit to Multi reader and partition of memory, the **BAND** is used.
Press **BAND** briefly to go to the next Driver
- You can't select previous Driver using the BAND button.

✦ Notes

- Don't remove a MP3 player or memory card while playing via a USB device.
- The maximum number of available files is 999 EA.
- Be sure to save file in the memory card after formatting.
- There is no support for hard type external cases.
- The maximum HARD MP3 (or memory, MP3 player etc.) player available is 32GB.
- MP3 players requiring installation of a drive is not supported.
- This unit supports FAT format (512 byte/sector).
- USB Hub is not supported. When connecting this unit to a USB Hub, "USB CHECK/NO USB" will be shown in the display window.
- Some memory sticks or cards may not be recognized depending on the type of memory card.
- The maximum number of available folders is 255 EA.
- There is no support for a USB device (Card reader, USB memory stick) that requires installation.
- If the connected device is not supported, "USB ERR1" or "USB ERR2" will appear on the display window.



Radio operation

Listening to radio stations

- 1 Press **SRC** to select the radio.
- 2 Press **BAND** repeatedly to select a band.
The indicator lights up in the following order. FM1 → FM2 → FM3 → MW(AM)
- 3 **Seek tuning** : Press **◀◀/▶▶** (**◀◀ ◀◀/▶▶ ▶▶** on the remote control).
The tuner will scan the frequencies until a broadcast with strong enough reception is found.
Manual tuning : Press **◀◀/▶▶** (Or press **◀◀ ◀◀/▶▶ ▶▶** on the remote control for more than 2 seconds and then repeatedly.).
The frequencies move up or down step by step.

★ **Note**

When the selected frequency is being broadcast in stereo, the “(((S)))” indicator will light.

Auto search memory

This function lets you automatically store the 6 strongest broadcast frequencies.

- 1 Press **SRC** to select the tuner.
- 2 Press and hold **AS/PS** for more than 1 second.
Scanning starts from the currently displayed frequency to higher frequencies and stops when 6 stations have been preset or the receivable frequencies have been scanned once.

Storing and recalling broadcast frequencies

You can easily store up to 6 broadcast frequencies for later recall at the touch of a button.

- 1 Select the desired frequency.
- 2 Press one of the **preset station 1 ~ 6** buttons for more than 1 second.
The number you have pressed will flash in the preset number indicator and then remain lit. The selected radio station frequency has been stored in the memory.
- 3 Repeat steps 1 and 2 to preset other stations.
The next time you press the same **preset station 1 ~ 6** buttons, the radio station frequency is recalled from the memory.

★ **Notes**

- As F1, F2, F3 have the same frequency range, up to 18 stations can be preset for FM.
- When a station is preset on the preset station button on which another station of the same band has already been preset, the previously preset station is automatically erased.

To scan the preset stations

Press **AS/PS** on the front panel. To stop the scanning, press **AS/PS**.

To tune in the preset stations

Press **BAND** to select the desired band and press the desired number (1-6).

The number of the **preset station 1 ~ 6** buttons is displayed and the preset station is received.

CD/MP3/WMA operation

Playing an Audio CD and MP3/WMA Disc

The unit can play MP3/WMA formatted recordings on CD-ROM, CD-R or CD-RW discs. Before playing MP3/WMA recordings, read the notes on MP3/WMA Recordings on page 18. This unit memorizes the last track from the last disc that was listened. The last track remains in the memory even if you remove the disc from the unit or switch off the unit. If you load a disc that has the track memorized, the track is automatically recalled.

To directly play a file, press the **NUMBER (#)** on remote control and then press the track number with the **0-9** number.

Pause **CD MP3 WMA**

- 1 Press **▶/||** during playback.
- 2 To return to playback, press **▶/||** again.

Skip to next track/file **CD MP3 WMA**

Press briefly **▶▶I** (**▶▶▶▶I** on the remote control) to select the next track or file.

Skip to previous track/file **CD MP3 WMA**

Press briefly **I◀◀** (**I◀◀◀◀** on the remote control) within 3 seconds of playing time.

Return to the beginning of the current track/file **CD MP3 WMA**

Press briefly **I◀◀** (**I◀◀◀◀** on the remote control) after 4 seconds of playing time.

Search **CD MP3 WMA**

Press and hold **◀◀/▶▶** (**I◀◀◀◀/▶▶▶▶I** on remote control) for about 1 second during playback and then release at the point you want.

Intro scan **CD MP3 WMA**

- 1 Press **SCAN**.
 - **SCAN** appears on the display window. **MP3 WMA**
 - (The first 10 seconds of each files in the current selected folder on the disc are played.)
 - SCAN** appears on the display window. **CD**
 - (The first 10 seconds of each files on the disc are played.)
 - Press and hold **SCAN** for about 2 seconds during playback.
 - SCAN** appears on the display window. **MP3 WMA**
 - (The first 10 seconds of each files on the disc are played.)
- 2 Press **SCAN** again.
 - SCAN** or ■ **SCAN** disappear from the display window.
 - (The intro scan is cancelled.)

Repeat **CD MP3 WMA**

- 1 Press **RPT** during playback.
 - 1 RPT** appears on the display window. **CD MP3 WMA**
 - (The current selected music on the disc is played repeatedly.)
 - Press and hold **RPT** for about 2 seconds during playback.
 - **RPT** appears on the display window. **MP3 WMA**
 - (The current selected folder on the disc is played repeatedly.)
- 2 Press **RPT** again.
 - 1 RPT** or ■ **RPT** disappear from the display window. (The repeat mode is cancelled.)



CD/MP3/WMA operation

Random **CD** **MP3** **WMA**

- 1 Press **SHF** during playback.
 - **SHF** appears on the display window. **MP3** **WMA**
(The current selected folder on the disc is played randomly.)
 - SHF** appears on the display window. **CD**
(All of the music on the disc is played randomly.)
 - Press and hold **SHF** for about 2 seconds during playback.
 - SHF** appears on the display window. **MP3** **WMA**
(All of the music on the disc is played randomly.)
- 2 Press **SHF** again.
 - SHF** or ■ **SHF** disappear from the display window. (The random playback is cancelled.)

Note

During random playback, if you press **I◀◀** (**I◀◀ ◀◀** on remote control), you won't go back to the previous track.

CD TEXT / ID3 TAG **CD** **MP3** **WMA**

When playing a disc containing information, you can view the CD TEXT/ID3 TAG information.

In a CD TEXT, some information about the disc (disc title, performer and track title) is recorded.

In a ID3 TAG, some information about the file (album title, performer's name, song title, recording year, music genre and a brief comment) is recorded.

If there is no information, "NO TEXT" will be shown on the display window.

Press **DISP/CLK** repeatedly during MP3/WMA/CD TEXT file playback.

MP3/WMA TRACK -10/+10 **MP3** **WMA** (If there is no folder or one folder.)

During playback, press **F-** to go back 10 tracks, and press **F+** to go forward 10 tracks.

MP3/WMA FOLDER UP/DOWN **MP3** **WMA** (If there are more than two folders.)

During playback, press **F-** to go back to the previous folder, and press **F+** to go forward to the next folder.

Notes

The time display appearing on the display part when playings VBR file may vary and there may be some difference from actual time (both progress time and VBR are displayed at the same time when playing file).

Troubleshooting

Symptom	Cause	Correction
Power doesn't turn on. The unit doesn't operate.	<ul style="list-style-type: none"> Leads and connectors are not properly connected. The fuse is blown. Noise and other factors are causing the built-in microprocessor to operate incorrectly. 	<ul style="list-style-type: none"> Confirm once more that all connections are correct. Rectify the problem that caused the fuse to blow, and then replace it. Be very sure to install the correct fuse with the same rate. Turn the unit off and then on.
Playback is not possible.	<ul style="list-style-type: none"> The disc is dirty. The loaded disc is of a type this unit cannot play. 	<ul style="list-style-type: none"> Clean disc. Check what type the disc.
No sound is heard. The volume level will not rise.	<ul style="list-style-type: none"> Cables are not connected correctly. 	<ul style="list-style-type: none"> Connect the cables correctly.
There's no sound.	<ul style="list-style-type: none"> The volume level is low. 	<ul style="list-style-type: none"> Adjust the volume.
There's audio skipping.	<ul style="list-style-type: none"> This unit is not firmly secured. 	<ul style="list-style-type: none"> Secure this unit firmly.
The unit does not operate correctly even when the appropriate remote control buttons are pressed.	<ul style="list-style-type: none"> Battery power is low. Some operations are prohibited with certain discs. 	<ul style="list-style-type: none"> Load new battery. Check using another disc.



Specifications

MP3/WMA Disc compatibility with this unit is limited as follows:

1. Sampling Frequency / 8 - 48kHz (MP3) 22.05 - 48kHz (WMA)
2. Bit rate / within 8 - 320kbps (include VBR) (MP3) 32 -320kbps (WMA)
3. CD-R/CD-RW physical format should be "ISO 9660"
4. If you record MP3/WMA files using software which cannot create a FILE SYSTEM, for example "Direct-CD" etc., it will not be possible to playback MP3/WMA files. We recommend that you use "Easy-CD Creator" which can create an ISO9660 file system.

Customers should also note that permission is required in order to download MP3/WMA files and music from the Internet.

Our company has no right to grant such permission.

Permission should always be sought from the copyright owner.

GENERAL

Output Power	.50W x 4CH (Max.)
Power Source	.DC 12V
Speaker impedance	.4 Ω
Ground System	Negative
Dimensions (W x H x D)	.180 x 51 x 171 mm (Without Front Panel)
Net Weight	.1.5 kg

CD SELECTION

Frequency Response	.20 Hz-20 kHz
S/N Ratio	.80 dB
Distortion	.0.1%
Channel Separation (1kHz)	.70 dB

RADIO SELECTION

FM

Frequency Range	.65-74, 87.5-107.9 or 87.5-108 MHz
S/N Ratio	.55 dB
Distortion	.0.7%
Usable Sensitivity	.12 dB μ V

AM (MW)

Frequency Range	.520-1720 or 522-1620 kHz
S/N Ratio	.45 dB
Distortion	.1.0%
Usable Sensitivity	.28 dB μ V