



MINI HOME THEATER

OWNER'S MANUAL

MODEL : LX-D2960
(LX-D2960A, LXS-D2960V)
LX-D2560
(LX-D2560A, LXS-D2560V)

Please read this manual carefully before operating your set.
Retain it for future reference.

Designs and specifications are subject to change without
notice for improvement.



Safety Precautions



CAUTION
RISK OF ELECTRIC SHOCK
DO NOT OPEN



WARNING: TO REDUCE THE RISK OF ELECTRIC SHOCK DO NOT REMOVE COVER (OR BACK) NO USER-SERVICEABLE PARTS INSIDE REFER SERVICING TO QUALIFIED SERVICE PERSONNEL.



This lightning flash with arrowhead symbol within an equilateral triangle is intended to alert the user to the presence of uninsulated dangerous voltage within the product's enclosure that may be of sufficient magnitude to constitute a risk of electric shock to persons.



The exclamation point within an equilateral triangle is intended to alert the user to the presence of important operating and maintenance (servicing) instructions in the literature accompanying the appliance.

WARNING: TO REDUCE THE RISK OF FIRE OR ELECTRIC SHOCK, DO NOT EXPOSE THIS PRODUCT TO RAIN OR MOISTURE.

CAUTION: Do not block any ventilation openings. Install in accordance with the manufacturer's instructions.

Slots and openings in the cabinet are provided for ventilation and to ensure reliable operation of the product and to protect it from over heating.

The openings should be never be blocked by placing the product on a bed, sofa, rug or other similar surface. This product should not be placed in a built-in installation such as a bookcase or rack unless proper ventilation is provided or the manufacturer's instruction have been adhered to.

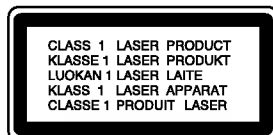

CAUTION:

This Product employs a Laser System.

To ensure proper use of this product, please read this owner's manual carefully and retain for future reference, should the unit require maintenance, contact an authorized service location-see service procedure.

Use of controls, adjustments or the performance of procedures other than those specified herein may result in hazardous radiation exposure.

To prevent direct exposure to laser beam, do not try to open the enclosure. Visible laser radiation when open. DO NOT STARE INTO BEAM.

CAUTION: The apparatus shall not be exposed to water, dripping or splashing and that no objects filled with liquids, such as vases, shall be placed on the apparatus.

CAUTION:

VISIBLE AND INVISIBLE LASER RADIATION WHEN OPEN AND INTERLOCKS DEFEATED

CAUTION concerning the Power Cord

Most appliances recommend they be placed upon a dedicated circuit;

That is, a single outlet circuit which powers only that appliance and has no additional outlets or branch circuits. Check the specification page of this owner's manual to be certain.

Do not overload wall outlets. Overloaded wall outlets, loose or damaged wall outlets, extension cords, frayed power cords, or damaged or cracked wire insulation are dangerous. Any of these conditions could result in electric shock or fire.

Periodically examine the cord of your appliance, and if its appearance indicates damage or deterioration, unplug it, discontinue use of the appliance, and have the cord replaced with an exact replacement part by an authorized servicer.

Protect the power cord from physical or mechanical abuse, such as being twisted, kinked, pinched, closed in a door, or walked upon. Pay particular attention to plugs, wall outlets, and the point where the cord exits the appliance.

Power Save Mode

You can set up the unit into an economic power save mode.

In power-on status, press and hold POWER (STANDBY/ON) button for about 3 seconds.

- Nothing is displayed in the display window when the unit is turned off.

To cancel, press POWER (STANDBY/ON), CLOCK, TIMER or DEMO.

Table of Contents

Introduction

Safety Precautions	2
Table of Contents	3
Before Use	3
Front Panel/ Rear Panel	4
Remote Control	5

Preparation

Connections	6-9
Before Operation	10-18

Operation

Operation with DVD and Video CD	18-21
Operation with Audio CD, CD-G and MP3/WMA Disc	21-22
Programmed Playback	22
Operation with JPEG Disc	23
Operation with DivX Disc	24
Operation with RADIO	25-26
Operation with TAPE	27

Reference

Troubleshooting	28
Language Code List	29
Area Code List	29
Specifications	

About Symbols

About the symbol display



“” may appear on the TV screen during operation. This icon means the function explained in this owner's manual is not available on that specific DVD video disc.

About the disc symbols for instructions

A section whose title has one of the following symbol is applicable only to the disc represented by the symbol.



	DVD
	Video CDs
	Audio CDs
	MP3 disc
	WMA disc
	JPEG disc
	DivX disc
	CD-G disc

About the symbols for instructions

-  Indicates hazards likely to cause harm to the unit itself or other material damage.
-  Indicates special operating features of this unit.
-  Indicates tips and hints for making the task easier.

Before Use

Playable Discs

	DVD (8 cm / 12 cm disc)
	Video CD (VCD) (8 cm / 12 cm disc)
	Audio CD (8 cm / 12 cm disc)

In addition, this unit can play a DVD±R, DVD±RW, SVCD, and CD-R or CD-RW that contains audio titles, MP3, WMA, JPEG or DivX files.

Notes

- Depending on the conditions of the recording equipment or the CD-R/RW (or DVD±R/RW) disc itself, some CD-R/RW (or DVD±R/RW) discs cannot be played on the unit.
- Do not attach any seal or label to either side (the labeled side or the recorded side) of a disc.
- Do not use irregularly shaped CDs (e.g., heart-shaped or octagonal). It may result in malfunctions.

Notes on DVDs and Video CDs

Some playback operations of DVDs and Video CDs may be intentionally fixed by software manufacturers. As this unit plays DVDs and Video CDs according to disc content designed by the software manufacturer, some playback features of the unit may not be available or other functions may be added.

Refer also to the instructions supplied with the DVDs and Video CDs. Some DVDs made for business purposes may not be played on the unit.

Regional code of the DVD player and DVDs

This DVD player is designed and manufactured for playback of region “4” encoded DVD software. The region code on the labels of some DVD discs indicates which type of player can play those discs. This unit can play only DVD discs labeled “4” or “ALL”. If you try to play any other discs, the message “Check Regional Code” will appear on the TV screen. Some DVD discs may not have a region code label even though their playback is prohibited by area limits.



Front Panel/ Rear Panel

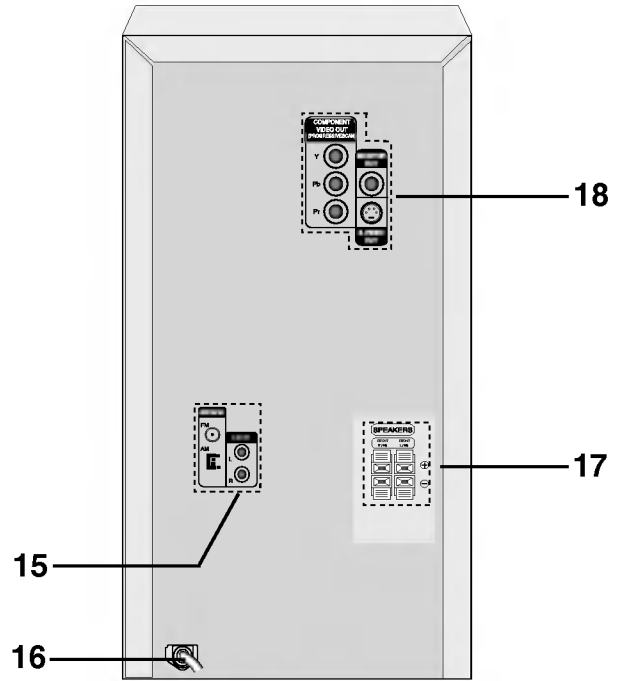
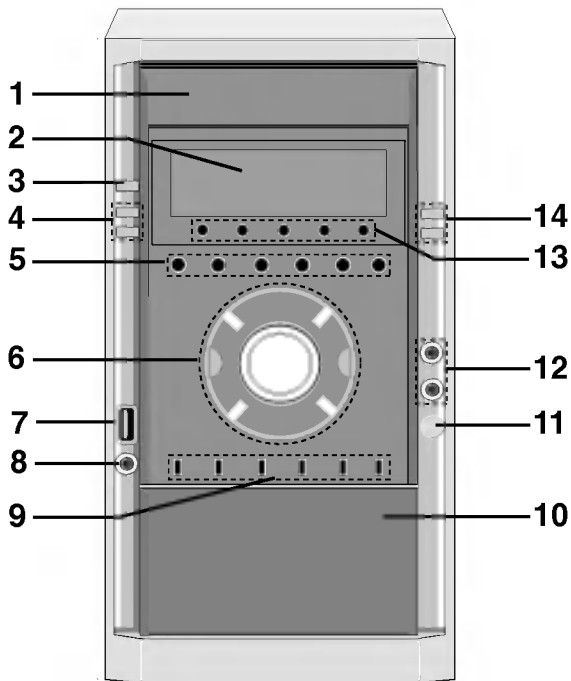

1. DISC DOOR
2. DISPLAY WINDOW
3. POWER (STANDBY/ON) button
4. • CLOCK button
• TIMER button
5. • SET/CD button, RDS button (OPTIONAL)
• PRESET (-/+) buttons
• TAPE REVERSE PLAY () button
• PLAY () button
• STOP () button
• CD SKIP/SEARCH (/), TAPE REWIND/
FAST FORWARD (/) , TUNING (-/+) buttons
6. • FUNCTION SELECT buttons
[TUNER, DVD, TAPE, USB (LX-D2960A model)]
• AUX button (LX-D2560A model)
• XDSS plus button
• Virtual E.X button
• VOLUME knob
7. USB connector (LX-D2960A model)
8. HEADPHONE SOCKET (PHONES) - ϕ 3.5mm
9. • XTS Pro button
• EQ master button
• CD SYNCHRO RECORDING (CD SYNC.) button
• MONO/STEREO (MONO/ST.) button
• REC/PAUSE () button
• AUX button (LX-D2960A model)
• DIMMER button (LX-D2560A model)

10. PUSH EJECT position
11. MIC VOLUME KNOB (MIC VOL. -/+)
12. MIC JACKS (MIC1, MIC2) - ϕ 3.5mm : OPTIONAL
13. DISC SELECT buttons
(DISC 1, DISC 2, DISC 3, DISC 4, DISC 5)
14. • OPEN/CLOSE button
• MODE/DEMO button
15. • FM/AM ANTENNA Connector
• AUXILIARY INPUT (AUX IN) connector
16. POWER CORD
17. SPEAKER Connectors
18. • COMPONENT VIDEO OUT (PROGRESSIVE SCAN)
(Y Pb Pr) Connector
• MONITOR OUT Connector
• S-VIDEO OUT Connector

Remote Control

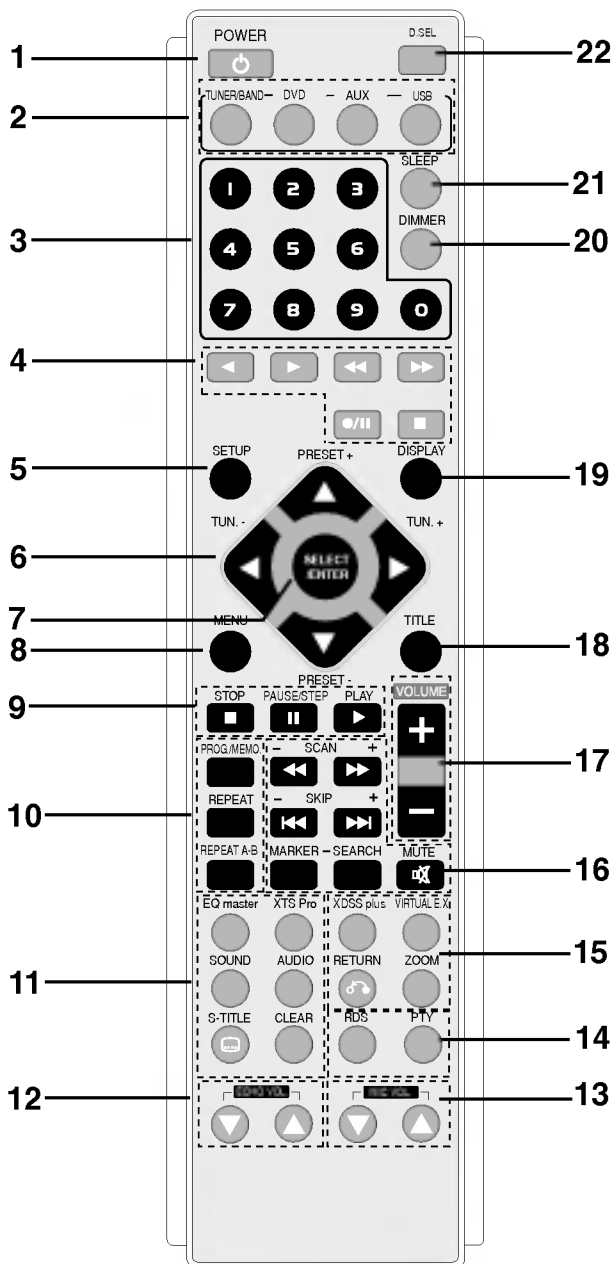

1. POWER button
2. FUNCTION SELECT buttons [TUNER/BAND, DVD, AUX, USB (LX-D2960A model)]
3. NUMERIC buttons (0-9)
4. TAPE FUNCTION buttons
 - REVERSE PLAY (◀)
 - PLAY (▶)
 - REWIND/ FAST FORWARD PLAY (◀◀/▶▶)
 - RECORD/ RECORD PAUSE (●/||)
 - TAPE STOP (■)
5. SET UP button
6.
 - ARROW buttons (▲ / ▼ / ◀ / ▶)
 - (For use in highlighting a selection on a GUI menu screen, TITLE and MENU screen.)
 - PRESET (-/+) buttons (▲ / ▼)
 - TUN. (-/+) buttons (◀ / ▶)
7. SELECT/ENTER button
8. MENU button
(Use the MENU button to display the menu screen included on DVD video discs.)
9. STOP (■), PAUSE (||) / STEP, PLAY (▶) buttons
10. PROG./MEMO., REPEAT, REPEAT A-B buttons
11. EQ master, XTS Pro, SOUND, AUDIO, SUBTITLE (S-TITLE), CLEAR buttons
12. ECHO VOL. (●/●) buttons
13. MIC VOL. (●/●) buttons
14. RDS, PTY buttons (OPTIONAL)
15. XDS plus, VIRTUAL E.X., RETURN, ZOOM buttons
16. SCAN (◀◀/▶▶) / SCAN (-/+) / SKIP (-/+) / SKIP (I◀◀/▶▶I), MARKER, SEARCH, MUTE buttons
17. VOLUME (-/+) buttons
18. TITLE button
(Use the TITLE button to display the title screen included on DVD video discs.)
19. DISPLAY button
20. DIMMER button
21. SLEEP button
22. DISC SELECT (D.SEL) button

Remote Control Operation Range

Point the remote control at the remote sensor and press the buttons.

- **Distance:** About 23 ft (7 m) from the front of the remote sensor
- **Angle:** About 30° in each direction of the front of the remote sensor

Remote control battery installation

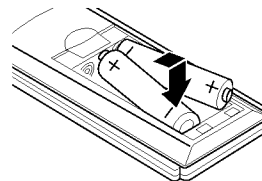

Detach the battery cover on the rear of the remote control, and insert two R03 (size AAA) batteries with + and - aligned correctly.

Caution

Do not mix old and new batteries. Never mix different types of batteries (standard, alkaline, etc.).

Connections

Connecting to a TV

- Make one of the following connections, depending on the capabilities of your existing equipment.

Tips

- Depending on your TV and other equipment you wish to connect, there are various ways you could connect the unit. Use one of the connections described below.
- Please refer to the manuals of your TV, VCR, Stereo System or other devices as necessary to make the best connections.

Caution

- Make sure the unit is connected directly to the TV. Select the correct AV input on your TV.
- Do not connect your unit to TV via your VCR. The DVD image could be distorted by the copy protection system.

Video connection

Connect the MONITOR OUT jack from the unit to the VIDEO IN jack on the TV using the video cable supplied (V).

S-Video connection

Connect the S-VIDEO OUT jack on the unit to the S-VIDEO IN jack on the TV using the S-Video cable (S).

Component Video (Color Stream®) connection

Connect the COMPONENT VIDEO OUT (PROGRESSIVE SCAN) jacks from the unit to the corresponding in jacks on the TV using an Y Pb Pr cable (C).

Progressive Scan (ColorStream® pro) connection

- If your television is a high-definition or “digital ready” television, you may take advantage of this unit’s progressive scan output for higher video resolution.
- If your TV does not accept the Progressive Scan format, the picture will appear scrambled if you try Progressive Scan on the unit.

Connect the COMPONENT VIDEO OUT (PROGRESSIVE SCAN) jacks from the unit to the corresponding in jacks on the TV using an optional Y Pb Pr cable (C).

Notes

- Set the Progressive to “On” in the Setup menu for progressive signal, see page 15.

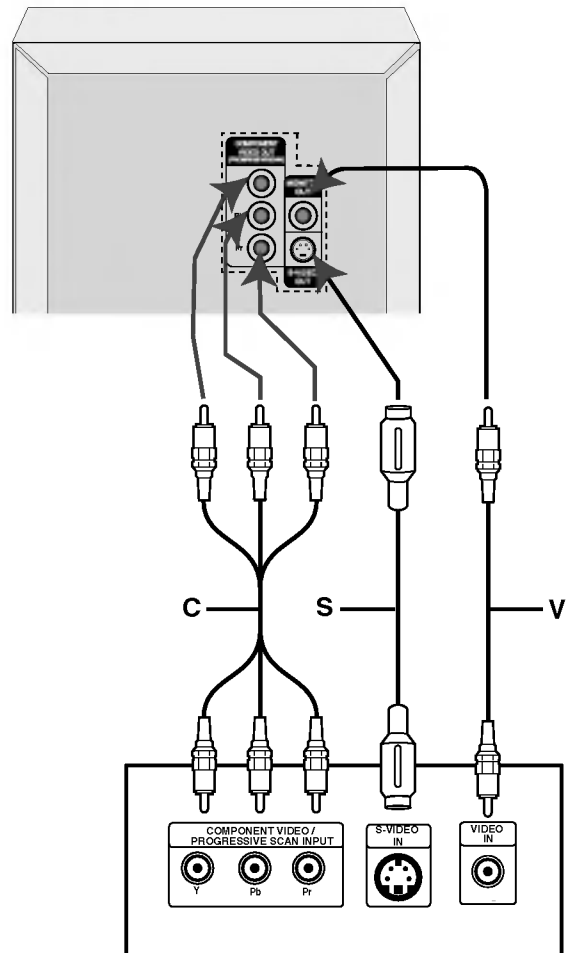

Rear of TV

Connections

Connecting to Antenna

Connect the supplied FM/AM antennas for listening to the radio.

- Connect the AM loop antenna to the AM antenna connector.
- Connect the FM wire antenna to the FM antenna connector.

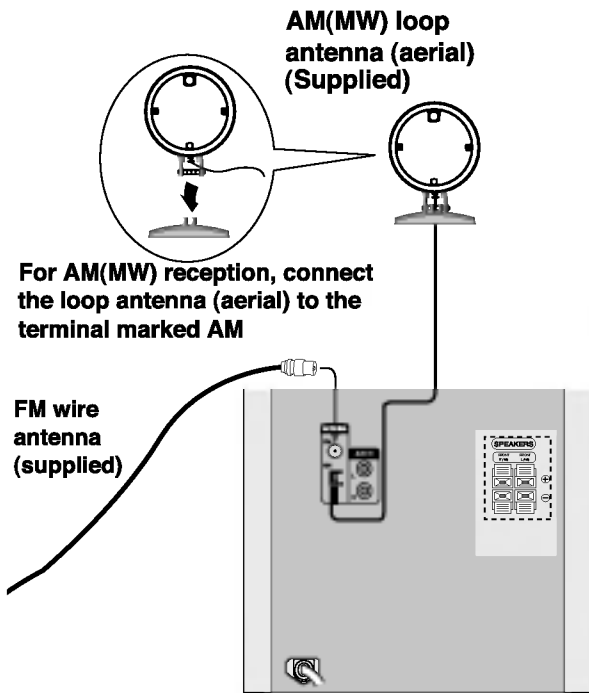

For AM(MW) reception, connect the loop antenna (aerial) to the terminal marked AM

FM wire antenna (supplied)

Notes

- To prevent noise pickup, keep the AM loop antenna away from the unit and other component.
- Be sure to fully extend the FM wire antenna.
- After connecting the FM wire antenna, keep it as horizontal as possible.

Connecting to Auxiliary Equipment

You can use VCR or other unit connected to the AUX connector.

This unit receives the analog signal from auxiliary equipment.

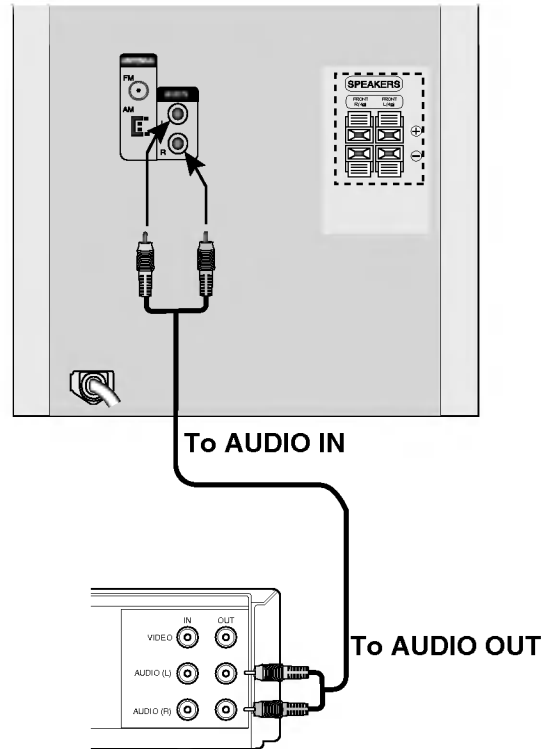

VCR (or Auxiliary Device, etc)

- 1** Connect a VCR or auxiliary device, etc to the AUX connector.
- 2** Press the AUX button on the front panel or the remote control until the "AUX" indicator is displayed in the display window.

Connections

Connecting USB (LX-D2960A model)

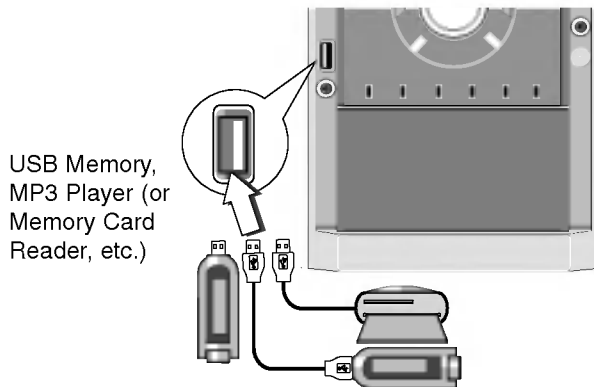

- 1** Connect the USB port of USB memory (or MP3 player, etc) to the USB connector on the front panel.
- 2** Select USB function by pressing the USB button on the front panel or the remote control. The "USB" is displayed in the display window.

To Remove the USB from the unit

1. Choose a different function mode or press the STOP (■) twice in a row.
2. Remove the USB from the unit.

Notes

- Don't extract the USB device in operating.
- Music files (MP3/WMA), image files (JPEG) and DivX files can be played.
- This unit can not use USB HUB.
- Recommended Memory Card
 - Compact Flash Card (CFC), Micro Drive (MD), Smart Media Card (SMC), Memory Stick (MS), Secure Digital Card (SD), Multi Media Card (MMC), Memory Stick Pro (MS-Pro)
 - Compatible with : FAT16,32
 - Only use the memory cards recommended.
- Devices which require additional program installation when you have connected the unit to a computer are not supported.
- In case of a USB HDD, make sure to connect an auxiliary power cord to the USB HDD for proper operation. A primary partition of drive is supported up to four. If there is an extension partition it is not supported.
- If the drive of USB device is two or more, a drive folder is displayed on the screen. If you want to move to the previous menu after you select a folder, Press RETURN.
- Digital camera and mobile phone are not supported.

Connections

Speaker System Connection

Connect the speakers using the supplied speaker cables by matching the colors of the terminals and those of the cords.

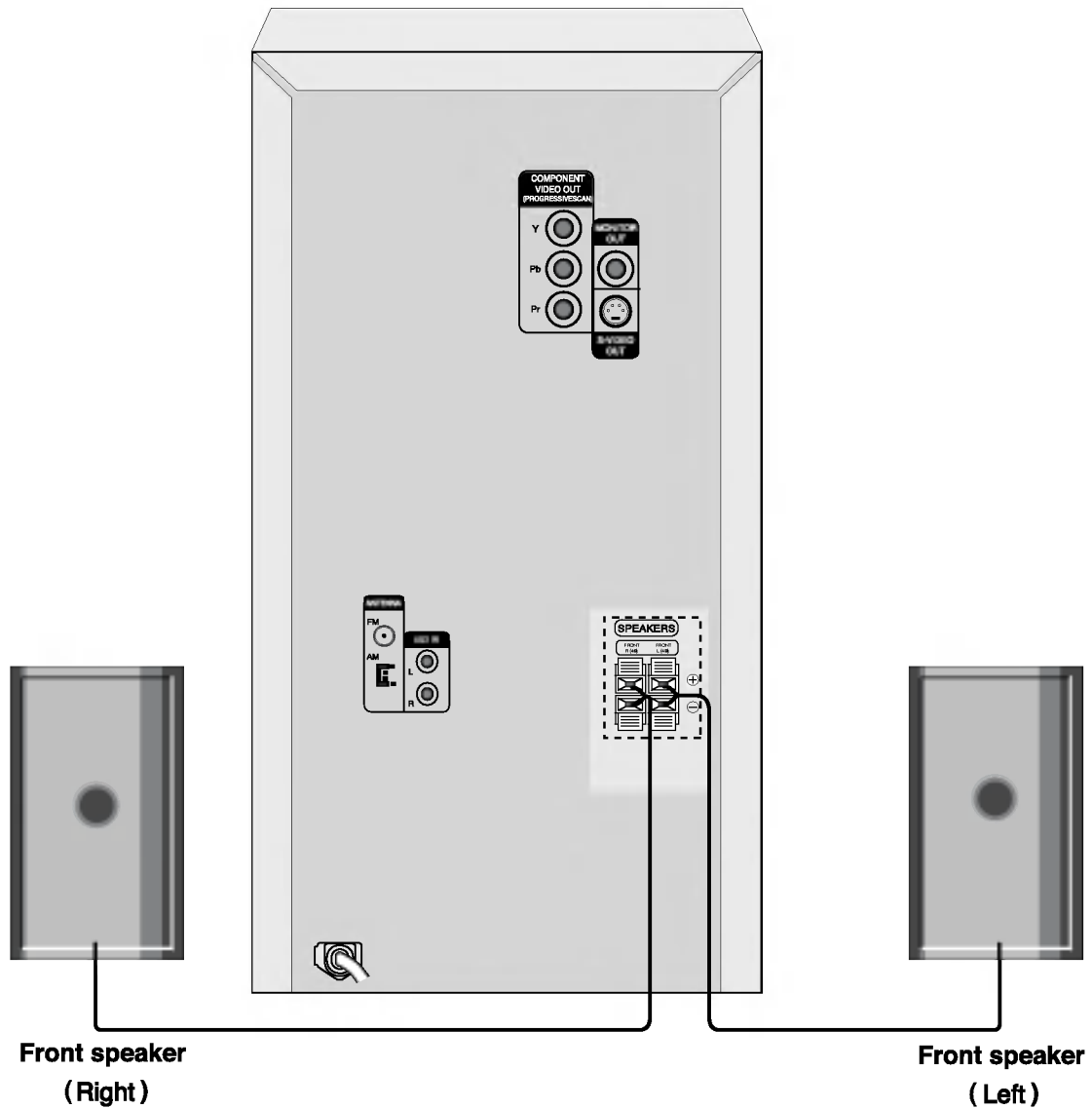

PREPARATION

Notes

- Be sure to match the speaker cable to the appropriate terminal on the components: + to + and – to –. If the cables are reversed, the sound will be distorted and will lack base.
- If you use front speakers with low maximum input rating, adjust the volume carefully to avoid excessive output on the speakers.
- Connect the Front Left/Right speaker correctly. If it is reversed, the sound may be distorted.

Before Operation

Volume Adjustment

- Turn VOLUME knob clockwise to increase the sound level, or counterclockwise to decrease it.
- Press VOLUME + to increase the sound level, or use VOLUME - to decrease it on the remote control.

MUTE

Press MUTE to turn off the sound, press again to restore.

"M" indicator flashes in the display window.

Headphone Jack

Connect a stereo headphone plug (ø3.5mm) into the headphone jack.

The speakers are automatically disabled when you plug in headphones (not supplied).

EQUALIZER Effect

You can choose 7 fixed sound impressions and adjust the BASS, MIDDLE and TREBLE.

- You can select a desired sound mode by using **EQ master** button on the front panel or the remote control.

When you want to change a sound mode press the **EQ master** button repeatedly within 3 seconds.

Each time you press the button the setting changes in the display window as shown below.

NORMAL → USER EQ → POP → CLASSIC
↑ ↓
JAZZ ← DRAMA ← ROCK

- You can set the BASS, MIDDLE and TREBLE on the USER EQ mode.
 1. Select the USER EQ mode by using **EQ master** button.
"USER EQ" will be displayed in the display window.
 2. Press the SET/CD button on the front panel when "USER EQ" is displayed in the display window.
"BASS 0" will be displayed in the display window.
 3. Select the BASS, MIDDLE or TREBLE you want by pressing the **PRESET (-/+)** buttons on the front panel.
 4. Press the **TUNING (-/+)** buttons on the front panel to set the sound level you want. (MIN, -4 ~ +4, MAX steps)
 5. Repeat the 3-4 steps as above.
 6. When the sound level is completed, press the the SET/CD button on the front panel.

XDSS (Extreme Dynamic Sound System)

You can improve the sound quality during playback. Press **XDSS plus** repeatedly on the remote control.

DVD/VCD/DivX/CD NORMAL ↔ XDSS ON

MP3/WMA NORMAL → XDSS ON → MP3 - OPT ON



XTS pro

Each time you press **XTS pro** the setting changes in the following order.

NORMAL ↔ XTS-P ON

- XTS-P ON
The unique sound quality of the LG Technology creates the optimum sound for you to play the perfect playback of the original sound and to feel the living sound source.

Notes

- The XTS mode is temporarily disabled when changing from 2.1 CH to 5.1 CH and it is enabled when changing it to 2.1 CH.
- This function does not work when the microphone is in use.

VIRTUAL sound



Press **VIRTUAL E.X** the setting virtual sound.

Source	Display	Effect
2.1 ch.	VIRTUAL	3D STEREO
5.1 ch	VIRTUAL	Virtual surround

- **3D STEREO**
Realtime 3D positioned sound rendering technology with stereo sources, optimized for stereo speakers. Listeners may experience amazing virtual surround effects with their own multimedia players.
- **Virtual surround**
A patent pending downmix technology converts 5.1 channel to 2 channel sound having directional information of audio..

Before Operation

Setting the Clock

- 1 Press CLOCK.**
(If the clock requires setting, press and hold **CLOCK** for more than 2 seconds.)
- The hours display begins to blink.
- 2 Select a 24 hour cycle or 12 hour cycle by pressing ◀▶ on the front panel.**
 (12HR) or  (24HR)
- 3 Press SET/CDII to confirm the selected hour cycle.**
- 4 Use ◀▶ on the front panel to set the correct hours.**
- 5 Press SET/CDII.**
- 6 Use ◀▶ on the front panel to set the correct minutes.**
- 7 Press SET/CDII and the correct time is shown in the display window.**

Sleep Timer Function

When the sleep timer is set, the unit automatically turns off after the specified time has elapsed.

- 1 To specify the time delay before the power is turned off, press SLEEP.**
In the display window you can see *SLEEP 180* for about 5 seconds. This means that the system turns off automatically after 180 minutes.
- 2 Each time you press SLEEP the setting changes in the following order.**
SLEEP 180 → 150 → 120 → 90 → 80 → 70 → 60 → 50 → 40 → 30 → 20 → 10 → OFF (No display) → SLEEP 180...
- 3 To check the remaining time until the power is turned off.**
While the sleep function is active press **SLEEP** briefly. The time remaining until the unit turns off is displayed for about 5 seconds.

Note

If you press **SLEEP** while the sleep time is displayed, the SLEEP time is reset.

To cancel Sleep Timer setting

If you wish to stop the function, press the **SLEEP** button repeatedly until "*SLEEP 10*" appears, and then press **SLEEP** once again after "*SLEEP 10*" shows on the display.

Using Microphone

You can sing to a music source by connecting a microphone to the unit.

- 1 Connect your microphone to the MIC socket.**
“*μ*” will be shown in the display window.
- 2 Play the music you want.**
- 3 Sing along with the accompaniment.**
Adjust the microphone volume by turning MIC VOLUME KNOB. (MIN,1 -14, MAX steps)

Notes

- When not using the microphone, set the MIC volume knob to minimum or turn off the MIC and remove the microphone from the MIC socket.
- If the microphone is set too near the speaker, a howling sound may be produced. In this case, move the microphone away from the speaker or decrease the sound level by using the MIC volume control.
- If sound through the microphone is extremely loud, it may be distorted. In this case, turn the MIC volume control toward minimum.

To Adjust ECHO Volume

You can give an echo effect to the sound from the microphones.

Press the ECHO VOL. (◐/◑) on the remote control to increase the echo volume or decrease it. (MIN,1 - 14, MAX steps)

DEMO

Press **DEMO** in power off state to demonstrate the function in the display window.

To cancel, press **POWER (STANDBY/ON)** or **DEMO** again.

DIMMER

This function dims the LED (Light-emitting diode) of front panel by half in power-on status.

Press **DIMMER** once. The LED (Light-emitting diode) of front panel is turned off and the display window will be darken by half. To cancel, press the button again.

Before Operation

Timer Function

With the TIMER function you can have the radio reception, CD play, USB (LX-D2960A model) play and TAPE play turned on and off at the time desired.

1 Press CLOCK to check the current time.

For your reference

If you don't set clock, timer function doesn't work.

2 Press TIMER to enter the timer setting mode. "TUNER→DVD/CD →USB (LX-D2960A model) →TAPE" flash in the display window in turn.

For your reference

If you want to correct the previous memorized TIMER setting, press and hold the **TIMER** button more than 2 seconds.

- The previous memorized timer setting for on Time and "Ⓞ" indicator appears in the display window.

3 Press SET/CDII when the desired function flashes.

4 1. a. When you select TUNER function, 'PLAY' and 'REC' indicator flash in the display window alternately for about 3 seconds.

'PLAY' indicator : TUNER play only
'REC' indicator : TUNER play and recording

b. Press SET/CDII when the desired function flashes.

c. Select the previous memorized preset number by pressing ◀▶ on the front panel and press SET.

'ON TIME' indicator appears for about 0.5 seconds in the display window and then disappears.

2. When you select DVD/CD, USB (LX-D2960A model) or TAPE function,

'ON TIME' indicator appears for about 0.5 seconds in the display window and then disappears.

5 Set the hour to switch on by pressing ◀▶ on the front panel.

6 Press SET/CDII to confirm the turn on hour time.

7 Set the minute to switch on by pressing ◀▶ on the front panel.

8 Press SET/CDII to confirm the turn on minutes time.

'OFF TIME' indicator appears for about 0.5 seconds in the display window and then disappears.

9 Set the hour to switch off by pressing ◀▶ on the front panel.

10 Press SET/CDII.

11 Set the minute to switch off by pressing ◀▶ on the front panel.

12 Press SET/CDII.

13 Adjust the volume level by pressing ◀▶ on the front panel.

14 Press SET/CDII.

"Ⓞ" appears in the display window and the timer setting has been completed.

15 Turn the system off.

The selected timer functions are automatically switched on and off at the preset times.

To cancel or check the timer

Each time the **TIMER** button is pressed you can select the timer set or cancel. You can also check the timer setting status.

To activate or check the timer, press the **TIMER** button repeatedly so that "Ⓞ" appears in the display window.

To cancel the **TIMER**, press the **TIMER** button repeatedly so that "Ⓞ" disappears from the display window.

Notes

- If you insert the DVD, VCD or DivX except audio CD/MP3/WMA on the unit, the timer function will be operated to the TUNER.
- This is not supported in the multi card reader.

Before Operation

Mini Glossary for Audio Stream & Surround mode

DIGITAL

The Dolby Digital surround format lets you enjoy up to 5.1 channels of digital surround sound from a Dolby Digital program source. If you play DVDs with "" mark, you can enjoy even better sound quality, greater spatial accuracy, and improved dynamic range. Manufactured under license from Dolby Laboratories. "Dolby", "Pro Logic" and double-D symbol are trademarks of Dolby Laboratories. Confidential Unpublished works. Copyright 1992-1997 Dolby Laboratories. All rights reserved.

BYPASS

Outputs the sound from the front left and right speakers and subwoofer.

Sound Mode

You can enjoy surround sound simply by selecting one of the pre-programmed sound fields according to the program you want to listen to.

When DVD is inserted

You can change the Digital Audio Output mode by pressing the **AUDIO** button on the remote control during playback. Although the DVD contents differ from disc to disc, the following explains the basic operation when this feature is used.

Each time you press SOUND button, the "BYPASS" indicator will only be shown in the display window.

When Video CD is inserted

Each time you press SOUND button, the sound mode of Video CD is changed in the display window in the following order.

BYPASS → ON STAGE → STUDIO → CLUB → HALL → THEATER 1 → CHURCH → BYPASS...

Note



After you select the "Bypass" of sound mode by pressing SOUND button, press AUDIO button. The Left, Right and Stereo of audio channel will be displayed on the TV screen.

When CD is inserted

Each time you press SOUND button, the sound mode of Audio CD is changed in the display window in the following order.

BYPASS → ON STAGE → STUDIO → CLUB → HALL → THEATER 1 → CHURCH → BYPASS...

For your reference

- Initial sound mode is **BYPASS**.
- You can identify the encoding format of program software by looking at its packaging.
 - Dolby Digital discs are labelled with the  logo.
 - Dolby Surround encoded programs are labelled with the  logo.

Notes

When you play sound tracks with 96kHz sampling frequency, the output signals will be converted to 48kHz (sampling frequency).

Before Operation



Caution:

Before using the remote control, press the **DVD** button to select the device to be operated.

General Explanation

This manual gives basic instructions for operating the unit. Some DVDs require specific operation or allow only limited operation during playback.

When this occurs, the symbol  appears on the TV screen, indicating that the operation is not permitted by the unit or is not available on the disc.



On-Screen Display

General playback status can be displayed on the TV screen. Some items can be changed on the menu.

On-screen display operation

- 1** Press **DISPLAY** during playback.
- 2** Press **▲** / **▼** to select an item.
The selected item will be highlighted.
- 3** Press **◀** or **▶** to change the setting of an item.
The number buttons can also be used for setting numbers (e.g., title number). For some functions, press **SELECT/ENTER** to execute the setting.

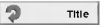
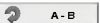
Temporary Feedback Field Icons







-  Repeat title
-  Repeat sequence
-  Resume play from this point
-  Action prohibited or not available







Notes

- Some discs may not provide all of the features on the on-screen display example shown below.
- If no button is pressed for 10 seconds, the on-screen display disappears.







Example: On-Screen Display during playing DVD

Items	Selection Method
Title Number  1 / 3 ▶	◀ / ▶, Numbers or SELECT/ENTER
Chapter Number  1 / 12 ▶	◀ / ▶, Numbers or SELECT/ENTER
Time search  0:20:09	Numbers, SELECT/ENTER
Audio language and Digital Audio Output mode  1 ENG DDD ▶ 5.1 CH	◀ / ▶ or AUDIO
Subtitle language  1 ENG ▶	◀ / ▶ or S-TITLE
Angle  1 / 3 ▶	◀ / ▶
Sound  Bypass ▶	◀ / ▶ or SOUND

Example: On-Screen Display during playing VCD or CD-G

Items	Selection Method
Track Number  1 / 3 ▶	◀ / ▶, Numbers or SELECT/ENTER
Time (Video CD only)  0:20:09	Numbers, SELECT/ENTER
Audio Channel  Stereo ▶	◀ / ▶ or AUDIO
Sound  Bypass ▶	◀ / ▶ or SOUND

Example: On-Screen Display during playing DivX movie disc

Items	Selection Method
Title Number  1 / 3 ▶	◀ / ▶, Numbers or SELECT/ENTER
Chapter Number  1 / 12 ▶	◀ / ▶, Numbers or SELECT/ENTER
Time search  0:20:09	Numbers, SELECT/ENTER
Audio language and Digital Audio Output mode  1 ENG DDD ▶ 5.1 CH	◀ / ▶ or AUDIO
Subtitle language  1 ENG ▶	◀ / ▶ or S-TITLE
Sound  Bypass ▶	◀ / ▶ or SOUND

Before Operation

Initial Settings

By using the Setup menu, you can make various adjustments to items such as picture and sound. You can also set a language for the subtitles and the Setup menu, among other things. For details on each Setup menu item, see pages 15 to 18.

To display and exit the Menu:

Press **SETUP** to display the menu. A second press of **SETUP** will take you back to initial screen.

To go to the next level:

Press **▶** on the remote control.

To go back to the previous level:

Press **◀** on the remote control.

General Operation

- 1** Press **SETUP**.
The setup menu appears.
- 2** Use **▲ / ▼** to select the desired option then press **▶** to move to the second level.
The screen will be shown the current setting for the selected item, as well as alternate setting(s).
- 3** Use **▲ / ▼** to select the second desired option then press **▶** to move to the third level.
- 4** Use **▲ / ▼** to select the desired setting then press **SELECT/ENTER** to confirm your selection.
Some items require additional steps.
- 5** Press **SETUP** or **PLAY** to exit the setup menu.

Note

If a CD-G disc is inserted, **SETUP** operation is available only when the CD-G menu appears on the TV screen.

LANGUAGE



OSD

Select a language for the Setup menu and on-screen display.

Disc Audio / Subtitle / Menu **DVD**

Select the language you prefer for the audio track (disc audio), subtitles, and the disc menu.

Original: Refers to the original language in which the disc was recorded.

Other: To select another language, press number buttons to enter the corresponding 4-digit number according to the language code list on page 29. If you enter the wrong language code, press **CLEAR** on the remote control.

DISPLAY



TV Aspect **DVD**

4:3: Select when a standard 4:3 TV is connected.

16:9: Select when a 16:9 wide TV is connected.

Display Mode **DVD**

Display Mode setting works only when the TV Aspect mode is set to "4:3".

Letterbox: Displays a wide picture with bands on the upper and lower portions of the screen.

Panscan: Automatically displays the wide picture on the entire screen and cuts off the portions that do not fit.

Progressive Scan **DVD**

Progressive Scan Video provides higher quality pictures with less flickering.

If you are using the Component Video jacks for connection to a TV or monitor that is compatible with a progressive scan signal, set Progressive Scan to On.

To Turn ON progressive scan:

Connect component out of the DVD to the input of your monitor/television, set your television or monitor to Component Input.

- Select "Progressive Scan" in the DISPLAY menu then press **▶**.
- Select "On" using the **▲ / ▼** buttons.
- Press **SELECT/ENTER** to confirm your selection. The confirm menu will appear.
- When the confirm menu appears on your screen "Cancel" is highlighted as default. Use the **◀ / ▶** buttons to highlight "Enter".
- Pressing **SELECT/ENTER** will set the player to Progressive scan mode.

Caution

Once the setting for progressive scan output is entered, an image will only be visible on a progressive scan compatible TV or monitor. If you set Progressive Scan to On in error, you must reset the unit.

- Remove any disc from the unit and close the disc tray. See that "NO DISC" is displayed in the display window.
- Press and hold **STOP** (■) for five seconds then release it. The video output will be restored to the standard setting, and a picture will once again be visible on a conventional analog TV or monitor.

Before Operation

AUDIO



Vocal **DVD**

Set Vocal to On only when a multi-channel Karaoke DVD is playing. The karaoke channels on the disc will mix into a normal stereo sound.

Dynamic Range Control (DRC) **DVD**

With the DVD format, you can hear a program's soundtrack in the most accurate and realistic presentation possible, thanks to digital audio technology. However, you may wish to compress the dynamic range of the audio output (the difference between the loudest sounds and the quietest ones). Then, you may listen to a movie at a lower volume without losing dialog intelligibility. Set DRC to On for this effect.

N Notes

- The DRC function works only during playback of Dolby Digital recorded discs.
- The level of Dynamic Range Compression may differ depending on the DVD disc.

Before Operation

LOCK (Parental Control)



Rating **DVD**

Some movies contain scenes that may not be suitable for children to view. Many of these discs contain parental control information that applies to the complete disc or to certain scenes on the disc. Movies and scenes are rated from 1 to 8, depending on the country. Some discs offer more suitable scenes as an alternative.

The parental control feature allows you to block access to scenes below the rating you input, thereby preventing your children from being able to view material you believe is unsuitable.

1 Select "Rating" on the LOCK menu then press **▶**.

2 To access the Rating, Password and Area Code features, you must input the 4-digit security code you created.

If you have not yet entered a security code you are prompted to do so.

Input a 4-digit code and press SELECT/ENTER. Enter it again and press SELECT/ENTER to verify. If you make a mistake before pressing SELECT/ENTER, press CLEAR.

3 Select a rating from 1 to 8 using the **▲ / ▼** buttons.

Rating 1-8: Rating one (1) has the most restrictions and rating eight (8) is the least restrictive.

Unlock

If you select unlock, parental control is not active and the disc plays in full.

Note

If you set a rating for the player, all disc scenes with the same rating or lower are played. Higher rated scenes are not played unless an alternate scene is available on the disc. The alternative must have the same rating or a lower one. If no suitable alternative is found, playback stops. You must enter the 4-digit password or change the rating level in order to play the disc.

4 Press SELECT/ENTER to confirm your rating selection, then press SETUP to exit the menu.

Password (Security Code)

You can enter or change password.

- 1 Select Password on the LOCK menu then press **▶**.
- 2 Follow step 2 as shown left (Rating). "Change" or "New" is highlighted.
- 3 Enter the new 4-digit code, then press SELECT/ENTER. Input it again to verify.
- 4 Press SETUP to exit the menu.

If you forget your Security Code

If you forget your security code you can clear it using the following steps:

- 1 Select Password on the LOCK menu.
- 2 Input the 6-digit number "210499" in the setup menu and the security code is cleared.
- 3 Enter a new code as described above.

Note

When "PASSWD [] [] [] [] [] []" appears on the TV screen, press STOP (**■**) and then press SETUP to move to the setup menu.

Area Code **DVD**

Enter the code of the country/area whose standards were used to rate the DVD video disc, based on the list in the reference chapter.

1 Select "Area Code" on the LOCK menu then press **▶**.

2 Follow step 2 as shown left (Rating).

3 Select the first character using **▲ / ▼** buttons.

4 Shift the cursor using **▶** button and select the second character using **▲ / ▼** buttons.

5 To complete the area code selection, press SELECT/ENTER.

Before Operation

OTHERS



PBC **VCD**

Set Playback Control (PBC) to On or Off.

On: Video CDs with PBC are played according to the PBC.

Off: Video CDs with PBC are played the same way as Audio CDs.

DivX(R) Registration **DivX**

You can show the DivX DRM (Digital Right Management) Registration code for your unit only.



The Registration code is used for VOD (Video-On-Demand) service agent. You can purchase or rental an encrypt movie file.

N Notes

If you rent the DivX VOD file, it has several options of viewing limits as show below.

- Display the number which you can watch the file.

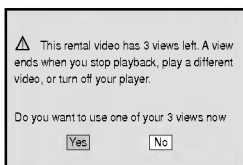

- The rental has been expired.

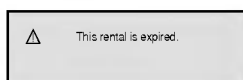

- Display the authorization error.

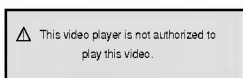

Operation with DVD and Video CD

Playing a DVD and Video CD

Playback Setup **DVD** **VCD**

- Turn on the TV and select the video input source connected to the unit.
- Audio system: Turn on the audio system and select the input source connected to the unit.

1 Press **OPEN/CLOSE** button to open the disc tray.

2 Load your chosen disc in the tray, with the playback side facing down.

3 Press **OPEN/CLOSE** button to close the tray. Playback starts automatically. If playback does not start, press **PLAY**.

In some cases, the disc menu might appear instead.

T If a menu screen is displayed

The menu screen may be displayed first after loading a DVD or Video CD which contains a menu.

DVD

Use the **▲/▼/◀/▶** buttons to select the title/chapter you want to view, then press **SELECT/ENTER** to start. Press **TITLE** or **MENU** to return to the menu screen.

VCD

Use the number buttons to select the track you want to view and press **RETURN** to return to the menu screen. Menu setting and the exact operating procedures for using the menu may differ depending on the disc. Follow the instructions on the each menu screen. You also may set PBC to Off.

N Notes

- If parental control is set and the disc is not within the rating settings you must input the password. (See "LOCK" on page 17.)
- DVDs may have a region code. Your player will not play discs that have a region code different from your player. The region code for this player is 4 (four).

To Select a disc directly

The unit can automatically play the selected disc.

- Press **DISC 1**, **DISC 2**, **DISC 3**, **DISC 4** or **DISC 5** on the front panel during playing or stopping.
- Press the **D.SEL** button on the remote control and then select a disc number you want to play by using the numeric buttons (1-5) on the remote control.

Operation with DVD and Video CD

General Features

Note

Unless stated otherwise, all operations described use the remote control. Some features may also be available in the Setup menu.

Moving to another TITLE **DVD** **DivX**

When a disc has more than one title, you can move to another title. Press DISPLAY while playback is stopped then the appropriate number (0-9) or use ◀/▶ to move to another title.

You can play any title by inputting its number while playback is stopped.

Moving to another CHAPTER/TRACK **DVD** **VCD** **DivX**

When a title on a disc has more than one chapter or a disc has more than one track, you can move to another chapter/track as follows:

- Press ◀◀ or ▶▶ briefly during playback to select the next chapter/track or to return to the beginning of the current chapter/track.
- Press ◀◀ twice briefly to step back to the previous chapter/track.
- To go directly to any chapter during DVD playback, press DISPLAY and press ▲/▼ to select the chapter/track icon. Then, input the chapter/track number or use ◀/▶.

Search **DVD** **VCD** **DivX**

- 1 Press ◀◀ or ▶▶ during playback.
The player will now go into SEARCH mode.
- 2 Press ◀◀ or ▶▶ repeatedly to select the required speed: ◀◀X2, ◀◀X4, ◀◀X8, ◀◀X16, ◀◀X100 (backward) or ▶▶X2, ▶▶X4, ▶▶X8, ▶▶X16, ▶▶X100 (forward).
With a DivX/ Video CD, the Search speed changes: ◀◀X2, ◀◀X4, ◀◀X8, ◀◀X16 (backward) or ▶▶X2, ▶▶X4, ▶▶X8, ▶▶X16 (forward).
- 3 To exit SEARCH mode, press PLAY.

Still Picture and Frame-by-frame playback **DVD** **VCD** **DivX**

- 1 Press PAUSE/STEP on the remote control during playback.
The player will now go into PAUSE mode.
- 2 You can advance the picture frame-by-frame by pressing PAUSE/STEP repeatedly on the remote control.

Slow Motion **DVD** **VCD**

- 1 Press PAUSE/STEP on the remote control during playback.
The player will now go into PAUSE mode.
- 2 Use the ◀◀ or ▶▶ to select the required speed: ◀◀ 1/2, ◀◀ 1/4, ◀◀ 1/8 or ◀◀ 1/16 [(backward) - DVD only] or ▶▶ 1/2, ▶▶ 1/4, ▶▶ 1/8 or ▶▶ 1/16 (forward).
- 3 To return to normal PLAY, press PLAY.

Note

Slow motion playback in reverse is not applicable for Video CD.

Repeat **DVD** **VCD** **DivX**

You can play a title/chapter/all/track on a disc.

Press REPEAT during playback to select a desired repeat mode.

DVD Video Discs - Repeat Chapter/Title/Off

- Chapter: repeats the current chapter.
- Title: repeats the current title.
- Off : does not play repeatedly.

DivX/ Video CDs - Repeat Track/All/Off

- Track : repeats the current track
- All : repeats all the tracks on a disc.
- Off : does not play repeatedly.

Note

– On a Video CD with PBC, you must set PBC to Off in the setup menu to use the repeat function (See “PBC” on page 18).

Repeat A-B **DVD** **VCD**

To repeat a sequence in a title:

- 1 Press REPEAT A-B at your chosen starting point.
“ A - ” appears briefly on the TV screen.
- 2 Press REPEAT A-B again at your chosen end point.
“ A - B ” appears briefly on the TV screen, and the repeat sequence begins.
- 3 To cancel the sequence, press REPEAT A-B.

Operation with DVD and Video CD

General Features (continued)

Time Search **DVD** **VCD** **DivX**

The Time Search function allows you to start playing at any chosen time on the disc.

- 1 Press DISPLAY during playback. The on-screen display appears on the screen.
The Time Search box shows the elapsed playing time of the current disc.
- 2 Within 10 seconds, press ▲ / ▼ to select the Time Search icon in the on-screen display.
The “:--:--” appears in the Time Search box.
- 3 Within 10 seconds, use the number buttons to enter the required start time. Enter hours, minutes, and seconds from left to right in the box.
If you enter the wrong numbers, press CLEAR to remove the numbers you entered. Then enter the correct numbers.
- 4 Within 10 seconds, press SELECT/ENTER to confirm the start time.
Playback starts from the selected time on the disc. If you enter an invalid time, playback will continue from the current point.

Zoom **DVD** **VCD**

The Zoom function allows you to enlarge the video image and to move through the enlarged image.

- 1 Press ZOOM during playback or still playback to activate the Zoom function.
If you press ZOOM repeatedly, the magnification level increases up to four steps.
100% size → 400% size → 800% size → 1600% size → 100% size
- 2 Use the ▲ / ▼ / ◀ / ▶ buttons to move through the zoomed picture.

Note

The zoom function may not work for some DVDs.

Marker Search **DVD** **VCD** **DivX**

You can start playback from a memorized point. Up to nine points can be memorized.

To enter a mark, follow these steps.

- 1 During disc playback, press MARKER when playback reaches the spot that you want to memorize.
The Marker icon will appear on the TV screen briefly.
- 2 Repeat step 1 to enter up to nine Marker points on a disc.

To Recall a Marked Scene

- 1 During disc playback, press SEARCH.
The MARKER SEARCH menu will appear on the screen.
- 2 Within 10 seconds, press ◀ / ▶ to select a Marker number that you want to recall.
- 3 Press SELECT/ENTER.
Playback will start from the Marked scene.
- 4 To remove the MARKER SEARCH menu, press SEARCH.

To clear a Marked Scene

- 1 During disc playback, press SEARCH.
The MARKER SEARCH menu will appear on the screen.
- 2 Press ◀ / ▶ to select the Marker number that you want to erase.
- 3 Press CLEAR.
The Marker number will be erased from the list.
- 4 Repeat steps 2 and 3 to erase additional Marker numbers.
- 5 To remove the MARKER SEARCH menu, press SEARCH.

Note

- On a Video CD with PBC, you must set PBC to Off on the setup menu to use the time search function (See “PBC” on page 18).

Special DVD Features

Checking the contents of DVD Video discs: Menus

DVDs may offer menus that allow you to access special features. To use the disc menu, press MENU. Then, press the appropriate number button to select an option.

Or, use the ▲ / ▼ / ◀ / ▶ buttons to highlight your selection, then press SELECT/ENTER.

Title Menu **DVD** **DivX**

- 1 Press TITLE.
If the current title has a menu, the menu will appear on the screen. Otherwise, the disc menu may appear.
- 2 The menu can list camera angles, spoken language and subtitle options, and chapters for the title.
- 3 To remove the title menu, press TITLE again.

Disc Menu **DVD** **DivX**

Press MENU.
The disc menu is displayed.

Camera Angle **DVD**

If the disc contains scenes recorded at different camera angles, you can change to a different camera angle during playback.

- 1 Press DISPLAY and then press the ▲ / ▼ to select an angle.
The number of the current angle appears in the display window.
- 2 Select a desired angle pressing the ◀ / ▶ buttons.

Operation with DVD and Video CD

Special DVD Features (continued)

Changing the Audio Language **DVD DivX**

Press AUDIO repeatedly during playback to hear a different audio language or audio track.

Changing the Audio Channel **VCD**

Press AUDIO repeatedly during playback to hear a different audio channel (STER., LEFT or RIGHT).

Subtitle **DVD DivX**

Press S-TITLE repeatedly during playback to see the different subtitle languages.

Note

If  appears, the feature is not available on the disc.

Last Scene Memory **DVD**

This player memorizes last scene from the last disc that is viewed. The last scene remains in memory even if you remove the disc from the player or switch off the player. If you load a disc that has the scene memorized, the scene is automatically recalled.

Note

This player does not memorize the scene of a disc if you switch off the player before commencing to play the disc.

Screen Saver



The screen saver appears when you leave the DVD player in Stop mode for about five minutes.

Operation with Audio CD, CD-G and MP3/WMA Disc

Playing an Audio CD, CD-G and MP3/WMA file **CD MP3 WMA**

The unit can play audio CD, CD-G and MP3/WMA.

Audio CD/CD-G disc

Once you insert an audio CD or CD-G disc a menu appears on the TV screen. Press  /  to select a track then press PLAY or SELECT/ENTER and playback starts. To display the CD-G menu during playback, press STOP () twice.

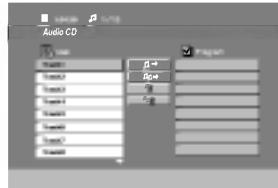





Audio CD Menu







CD-G Menu

MP3 / WMA

1. Press  /  to select a folder, and press SELECT/ENTER to see the folder contents.
2. Press  /  to select a track then press PLAY or SELECT/ENTER. Playback starts.





Notes

- If you are in a file list on the MUSIC menu and want to return to the Folder list, use the  /  to highlight  on the stop mode and press SELECT/ENTER.
- Press MENU to move to the next page.
- On a CD with MP3/WMA file and JPEG file, you can switch MP3/WMA and JPEG menu. Press TITLE on the stop mode and MP3/WMA or JPEG word on top of the menu is highlighted. Then, use  /  to select MP3/WMA or JPEG then press SELECT/ENTER.
- The MP3 file name and ID3 TAG should be named using English.

Pause **CD MP3 WMA CD-G**

- 1 Press PAUSE/STEP during playback.
- 2 To return to playback, press PLAY or press PAUSE/STEP again.

Moving to another Track **CD MP3 WMA CD-G**

- Press  or  briefly during playback to go to the next track or to return to the beginning of the current track.
- Press  twice briefly to step back to the previous track.
- In case of audio CD, to go directly to any track, enter the track number using the numbered buttons (0-9) during playback.

Operation with Audio CD, CD-G and MP3/WMA Disc

Repeat Track/All/Off

CD MP3 WMA CD-G

You can play a title/chapter/all/track on a disc.

- 1 Press REPEAT when playing a disc. The repeat icon appears.
- 2 Press REPEAT to select a desired repeat mode.
 - Track: repeats the current track
 - All: repeats all the tracks on a disc.
 - Off (No display) : does not play repeatedly.

Search

CD MP3 WMA

- 1 Press ◀◀ or ▶▶ during playback.
The player will now go into SEARCH mode.
- 2 Press ◀◀ or ▶▶ repeatedly to select the required speed: ◀◀X2, ◀◀X4, ◀◀X8 (backward) or ▶▶X2, ▶▶X4, ▶▶X8 (forward).
- 3 To exit SEARCH mode, press PLAY.

MP3 / WMA disc compatibility with this player is limited as follows:

- Sampling frequency: within 32 - 48 kHz (MP3), within 24 - 48kHz (WMA)
- Bit rate: within 32 - 320kbps (MP3), 40 - 192kbps (WMA)
- The player cannot read an MP3/WMA file that has a file extension other than ".mp3" / ".wma".
- CD-R physical format should be ISO 9660
- If you record MP3 / WMA files using software that cannot create a file system (eg. Direct-CD) it is impossible to playback MP3 / WMA files. We recommend that you use Easy-CD Creator, which creates an ISO 9660 file system.
- File names should have a maximum of 8 letters and must incorporate an .mp3 or .wma extension.
- They should not contain special letters such as / ? * : " < > | etc.
- The total number of files on the disc should be less than 999.

This unit requires discs and recordings to meet certain technical standards in order to achieve optimal playback quality. Pre-recorded DVDs are automatically set to these standards. There are many different types of recordable disc formats (including CD-R containing MP3 or WMA files) and these require certain pre-existing conditions (see above) to ensure compatible playback.

Customers should note that permission is required in order to download MP3 / WMA files and music from the Internet. Our company has no right to grant such permission. Permission should always be sought from the copyright owner.

Programmed Playback

CD MP3 WMA CD-G

The Program function enables you to store your favorite tracks from any disc in the player memory.

A program can contain 300 tracks (Audio CD/CD-G/MP3/WMA).

1 Insert a disc.

Audio CD, CD-G and MP3/WMA Discs:

Audio CD, CD-G or MP3/WMA menu appears as below.

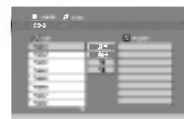

Audio CD Menu

MP3/WMA Menu

CD-G Menu

2 Select a track on the List.

3 Press PROG./MEMO.. Or, select "➔ (Add)" icon then SELECT/ENTER to place the selected track on the Program list. Repeat to place additional tracks on the list.

Note

You can add all tracks in the disc. Select "➔ (Add All)" icon then press SELECT/ENTER.

4 Select the track you want to start playing on the Program list.

Tip

Press MENU to move to the next page.

5 Press PLAY or SELECT/ENTER to start.

Playback begins in the order in which you programmed the tracks and "PROG." appears in the display window. Playback stops after all of the tracks on the Program list have played once.

Note

To resume normal playback from programmed playback, select a track of AUDIO CD (or MP3/WMA) list and then press PLAY.

Repeat Programmed Tracks

You can play a title/chapter/all/track on a disc.

- 1 Press REPEAT when playing a disc. The repeat icon appears.
- 2 Press REPEAT to select a desired repeat mode.
 - TRACK: repeats the current track
 - ALL: repeats all the tracks on a disc.
 - Off (No display): does not play repeatedly.

Erasing a Track from Program List

- 1 Use ▲ / ▼ / ◀ / ▶ to select the track that you wish to erase from the Program list.
- 2 Press CLEAR. Or, select "⊗ (Delete)" icon then Press SELECT/ENTER to place the selected track on the Program list. Repeat to erase additional tracks on the list.

Erasing the Complete Program List

Select "⊗ (Del all)", then press SELECT/ENTER. The complete Program for the disc is erased.

Note

The programs are also cleared when the disc is removed.

Operation with JPEG Disc

Viewing a JPEG disc **JPEG**

This unit can play discs with JPEG files.
Before playing JPEG recordings, read the notes on JPEG Recordings on right.

- 1 Insert a disc and close the tray.**
The PHOTO menu appears on the TV screen.

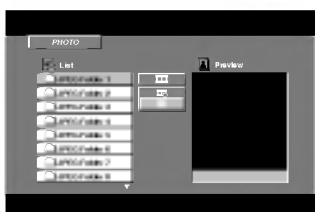

- 2 Press ▲ / ▼ to select a folder, and press SELECT/ENTER. A list of files in the folder appears.**

Tip

If you are in a file list and want to return to the Folder list, use the ▲ / ▼ buttons on the remote control to highlight "■" and press SELECT/ENTER to return to the previous menu screen.

- 3 If you want to view a particular file, press ▲ / ▼ to highlight a file and press SELECT/ENTER or PLAY.**

Slide Show starts from the selected file if Speed option is not Off.

While viewing a file, you can press STOP(■) to move to the previous menu (JPEG menu).

Tip

- Press MENU to move to the next page.
- There are four Slide Speed options: ■ : > (Slow), >> (Normal), >>> (Fast) and II (off).
Use ▲ / ▼ / ◀ / ▶ to highlight the Speed. Then, use ◀ / ▶ to select the option you want to use then press SELECT/ENTER.
- If you set Speed option to Off, Slide Show is not active.

Slide Show **JPEG**

Use ▲ / ▼ / ◀ / ▶ to highlight the ■ (Slide Show) then press SELECT/ENTER.

Moving to another File **JPEG**

Press ◀◀ or ▶▶ once during viewing a picture to advance to the next file or to the previous file.

Still Picture **JPEG**

- 1 Press PAUSE/STEP during slide show.
The player will now go into PAUSE mode.
- 2 To return to the slide show, press PLAY or press PAUSE/STEP again.

To rotate picture **JPEG**

Press ▲ / ▼ / ◀ / ▶ during showing a picture to rotate the picture clockwise or counter-clockwise.

Zoom **JPEG**

The Zoom function allows you to enlarge or reduce the video image.

- 1 Press ZOOM repeatedly.
Zoom on ↔ Zoom off
- 2 Use the ▲ / ▼ / ◀ / ▶ buttons on the "Zoom on" mode.

JPEG disc compatibility with this player is limited as follows:

- Depending upon the size and number of JPEG files, it could take a long time for the DVD player to read the disc's contents. If you don't see an on-screen display after several minutes, some of the files may be too large — reduce the resolution of the JPEG files to less than 2760 x 2048 pixels and burn another disc.
- The total number of files and folders on the disc should be less than 999.
- Some discs may be incompatible due to a different recording format or the condition of disc.
- Ensure that all the selected files have the ".jpg" extensions when copying into the CD layout.
- If the files have ".jpe" or ".jpeg" extensions, please rename them as ".jpg" file.
- File names without ".jpg" extension will not be able to be read by this DVD player. Even though the files are shown as JPEG image files in Windows Explorer.

Operation with DivX Disc

The unit can play the DivX files.

- 1 Insert a disc and close the tray.**
The DivX menu appears on the TV screen.

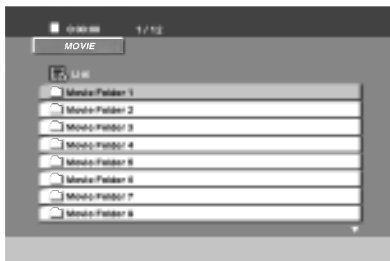

- 2 Press ▲ / ▼ to select a folder, and press SELECT/ENTER to see the folder contents.**

Tip

If you are in a file list and want to return to the Folder list, use the ▲ / ▼ buttons on the remote control to highlight "⏪" and press SELECT/ENTER to return to the previous menu screen.

- 3 If you want to view a particular file, press ▲ / ▼ to highlight a file and press SELECT/ENTER or PLAY.**
Playback starts.

- 4 Press STOP(■) to exit.**

Notes

- Be sure to select "SUBTITLE ON" mode by pressing the subtitle file every time before playing a DivX file .
- When the subtitle has more than two languages in the file, original subtitle is only available.
- The DivX files in your memory card can not be played.
- The microphone does not work during playing a DivX file.
- You can not adjust the sound mode and VIRTUAL sound during playing a DivX file.

Notice for displaying the Divx subtitle

If the subtitle does not display properly during playback, press and hold S-TITLE about 3 seconds then press S-TITLE to select another language code until the subtitle is displayed properly

DivX disc compatibility with this player is limited as follows:

- Available resolution size of the DivX file is under 720x576 (W x H) pixel.
- The file name of the DivX subtitle is available by 20-40 characters (differs from language).
- If there is impossible code to express in the DivX file, it may be displayed as " _ " mark in the display.
- **If the number of the screen frame is over 30 per 1 second, this unit may not operate normally.**
- **If the video and audio structure of recorded file is not interleaved, either video or audio is out-putted.**

Playable DivX subtitle file

- SubRip(*.srt/*.txt)
- SAMI(*.smi)
- SubStation Alpha(*.ssa/*.txt)
- MicroDVD(*.sub/*.txt)
- SubViewer 2.0(*.sub/*.txt)
- VobSub(*.sub)

Playable DivX file

- ".avi ", ".mpg ", ".mpeg "

Playable Codec format

- "DIVX3.xx ", "DIVX4.xx ", "DIVX5.xx ", "XVID ", "MP43 ", "3IVX ", "MP42 "

Playable Audio format

- "AC3 ", "DTS ", "PCM ", "MP3 ", "WMA "
- Sampling frequency: within 32 - 48 kHz (MP3), within 24 - 48kHz (WMA)
- Bit rate: within 32 - 320kbps (MP3), 40 - 192kbps (WMA)

Operation with RADIO

Presetting the radio stations

You can preset 50 stations for FM and AM.
Before tuning, make sure that you have turned the volume down to the minimum level.

- 1 Press TUNER/BAND on the remote control to show either FM or AM in the display window. Or Press TUNER on the front panel.**
Every time you press this button, AM and FM changes alternately.
- 2 Select a station you want by pressing TUNING (-/+) on the front panel or ◀/▶ on the remote control.**

Notes

• Automatic Tuning

Press TUNING (-/+) or ◀/▶ for more than 0.5 second.

- Scanning stops when the unit tunes in a station.

• Manual Tuning

Press TUNING (-/+) or ◀/▶ briefly and repeatedly.

- 3 Press PROG./MEMO. on the remote control.**
A preset number will flash in the display window.
- 4 Press ▲/▼ on the remote control to select the preset number you want.**
- 5 Press PROG./MEMO. again.**
The station is stored.
- 6 Repeat steps 1 (or 2) to 5 to store other stations.**

To clear all memorized stations

Press and hold PROG./MEMO. on the remote control for about two seconds, "ERASE ALL" appears in the display window and then press PROG./MEMO. on the remote control, the stations are cleared.

For your reference

If all stations have already been entered, "FULL" message will appear in the display window for a moment and then a preset number will flash.
To change the preset number, follow the steps 4-5 .

To recall preset numbers

Press and hold ▲/▼ on the remote control until the desired preset number appears or press the button repeatedly.

Listening to the radio

- 1 Press TUNER/BAND on the remote control to show either FM or AM in the display window. Or Press TUNER on the front panel.**
The last received station is tuned in.
- 2 Press ▲/▼ on the remote control repeatedly to select the preset station you want.**
Each time you press this button, the unit tunes in the next preset station.
- 3 Adjust the volume by rotating VOLUME CONTROL KNOB (or pressing VOLUME (-/+) on the remote control) repeatedly.**

To listen to non-preset radio stations

- For manual tuning, see "Manual Tuning".
- For automatic tuning, see "Automatic Tuning".

To select a preset radio station directly

You can use the number buttons on the remote control to select a preset radio station directly.
For example, to listen to preset station 4, press 4 on the remote control. To listen to preset station 19, press 1 then 9 (within 3 seconds).

To turn the radio off

Press POWER to turn off the unit or select another function mode [DVD, TAPE, AUX or USB (LX-D2960A model)].

For your reference

- **If a FM program is noisy**
Press MONO/ST. repeatedly so that "((••))" disappears in the display window. There will be no stereo effect, but the reception will improve. Press MONO/ST. again to restore the stereo effect.
- **To improve reception**
Reposition the supplied antennas.

Operation with RADIO

RDS Function : OPTIONAL

About RDS : OPTIONAL

This unit is equipped with RDS (Radio Data System), which brings a wide range of information from FM radio. RDS is a system for transmitting station call signs or network information, a description of station programme type text message about the station or specifics of musical selection and the correct time.

RDS Tuning : OPTIONAL

When a FM station containing RDS data is tuned in, the unit will automatically display the station's call sign and the RDS indicator will light in the Display Window as well as indicators for the programme type recognition (PTY), Radio Text (RT), Clock Time (CT) and RDS services programme (PS) if transmitted by the station.

RDS Display Options : OPTIONAL

The RDS system is capable of transmitting a wide variety of information in addition to the initial call sign that appears when a station is first tuned. In normal RDS operation the display will indicate the station name, broadcast network or call letters. Pressing **RDS** on the front panel enables you to cycle through the various data types in the sequence:

(FREQUENCY → PTY → RT → CT → PS)



- **PTY (Programme type recognition)**- The programme type is shown in the display window.
- **RT (Radio text recognition)**- The radio station's name is displayed in the display window.
- **CT (Time controlled by the channel)**- Enable the unit to receive the actual time and show it on the display window.
- **PS (Programme Service name)**- The programme title is displayed in the display window.

Note

Some RDS stations may not choose to include some of these additional features. If the data required for the selected mode is not being transmitted, the Display Window will show a **PTY NONE**, **RT NONE**, **CT NONE**, **PS NONE** message.

Programme Search (PTY) : OPTIONAL

A major benefit of RDS is its ability to encode broadcasts with Programme Type (PTY) codes that indicate the type of material being broadcast. The following list shows the abbreviations used to indicate each PTY along with an explanation of the PTY.

NEWS	News
AFFAIRS	Current Affairs
INFO	Information
SPORT	Sports
EDUCATE	Educational
DRAMA	Drama
CULTURE	Culture
SCIENCE	Science
VARIED	Varied Speech Programme
POP M	Popular Music
ROCK M	Rock Music
EASY M	Easy Listening Music
LIGHT M	Classical Music
CLASSICS	Serious Classical Music
OTHER M	Other Music
WEATHER	Weather Information
FINANCE	Financial Programmes
CHILDREN	Children's Programmes
SOCIAL	Social Affairs Programmes
RELIGION	Religious Broadcasts
PHONE IN	Phone-In Programmes
TRAVEL	Travel and Touring
LEISURE	Leisure and Hobby
JAZZ	Jazz Music
COUNTRY	Country Music
NATION M	National Music
OLDIES	Oldies Music
FOLK M	Folk Music
DOCUMENT	Documentary Programmes
TEST	Station Alarm Test Message
ALARM 1	Emergency Broadcast Information

You may search for a specific Programme Type (PTY) by following these steps:

- 1** Press **TUNER** (or **TUNER/BAND**) to select FM mode.
- 2** Press **PTY** on the remote control, the display will show the last PTY in use.
- 3** Press **PTY** repeatedly to select a desired PTY.
- 4** When the PTY is selected, press and hold **PTY**. The unit will go into an automatic search mode. When a station is tuned, the search will stop.





Operation with TAPE

Basic Playback

- 1 Press **TAPE** to select tape function.
("NO TAPE" appears in the display window.)
- 2 Open cassette deck by pushing to the **▲PUSH EJECT** position.
- 3 Insert a cassette with the tape side to the bottom and then close deck.
- 4 Press **▶** (or **◀**) on the front panel or remote control.

AUTO REVERSE DECK

You can select direction of the cassette you want by pressing **MODE**.

Pressing	Display	Function
-	 	After the cassette plays front or reverse (backward play) side, stops automatically.
Once		After the cassette plays front and reverse side, stops automatically.
Twice		After the cassette of plays six times repeatedly front and reverse side, stops automatically.

To Stop Play

Press **STOP(■)** on the front panel or **TAPE STOP(■)** on the remote control during playback.

To Play Rewind or Fast Forward

After press **◀◀/▶▶** on the front panel or **◀◀/▶▶** on the remote control during playback or stop, press **▶** (or **◀**) at the tape position you want.

Recording from Radio, CD or Auxiliary source

- 1 Press the function (**CD**, **TUNER/BAND**, **AUX** or **USB**) you want.
- 2 Open the cassette deck and insert a blank cassette into the cassette compartment.
To set the recording direction
Press **MODE** repeatedly to set the recording direction.
- 3 Press **REC/PAUSE (●/||)** on the front panel or **●/||** on the remote control.
"REC" flashes and holds the cassette in pause mode.
- 4 Press **REC/PAUSE (●/||)** on the front panel or **●/||** remote control.
The recording is begun.
To pause the recording
Press **●/||** (or **REC/PAUSE (●/||)**) during recording.
To stop the recording
Press **STOP(■)**.

CD- Synchro recording

This feature is a convenient to record tracks from CD to cassette.

- 1 Select the **CD** function and load a **CD** to be recorded.
You may wish to program a selection of tracks for recording.
- 2 Open the cassette deck and insert a blank cassette into the tape tray.
- 3 Press **CD SYNC.** in stop mode.
"REC" flashes and "**CD SYNC**" displays in the display window.
- 4 The synchronized recording is started automatically after about 7 seconds.

Notes

- If you wish to record from the desired track, select the desired track with **◀◀/▶▶** before commencing CD synchro recording.
- A function change is not possible during recording.

Troubleshooting

Check the following guide for the possible cause of a problem before contacting service.

Symptom	Cause	Correction
No power.	<ul style="list-style-type: none"> The power cord is disconnected. 	<ul style="list-style-type: none"> Plug the power cord into the wall outlet securely.
The power is on, but the unit does not work.	<ul style="list-style-type: none"> No disc is inserted. 	<ul style="list-style-type: none"> Insert a disc. (Check that the DVD or, audio CD indicator in the DVD display is lit.)
No picture.	<ul style="list-style-type: none"> The TV is not set to receive DVD signal output. 	<ul style="list-style-type: none"> Select the appropriate video input mode on the TV so the picture from the unit appears on the TV screen.
	<ul style="list-style-type: none"> The video cable is not connected securely. 	<ul style="list-style-type: none"> Connect the video cable into the jacks securely.
	<ul style="list-style-type: none"> The connected TV power is turned off. 	<ul style="list-style-type: none"> Turn on the TV.
There is no sound or only a very low-level sound is heard.	<ul style="list-style-type: none"> The equipment connected with the audio cable is not set to receive DVD signal output. 	<ul style="list-style-type: none"> Select the correct input mode of the audio so you can listen to the sound from the unit.
	<ul style="list-style-type: none"> The audio cables are not connected securely. 	<ul style="list-style-type: none"> Connect the audio cable into the jacks securely.
	<ul style="list-style-type: none"> The power of the equipment connected with the audio cable is turned off. 	<ul style="list-style-type: none"> Turn on the equipment connected with the audio cable.
	<ul style="list-style-type: none"> The audio connecting cord is damaged. 	<ul style="list-style-type: none"> Replace it with new one.
The playback picture is poor.	<ul style="list-style-type: none"> The disc is dirty. 	<ul style="list-style-type: none"> Clean the disc.
The unit does not start playback.	<ul style="list-style-type: none"> No disc is inserted. 	<ul style="list-style-type: none"> Insert a disc. (Check that the DVD, or audio CD indicator in the DVD display is lit.)
	<ul style="list-style-type: none"> An unplayable disc is inserted. 	<ul style="list-style-type: none"> Insert a playable disc. (Check the disc type, color system and Regional code.)
	<ul style="list-style-type: none"> The disc is placed upside down. 	<ul style="list-style-type: none"> Place the disc with the playback side down.
	<ul style="list-style-type: none"> The disc is not placed within the guide. 	<ul style="list-style-type: none"> Place the disc on the disc tray correctly inside the guide.
	<ul style="list-style-type: none"> The disc is dirty. 	<ul style="list-style-type: none"> Clean the disc.
	<ul style="list-style-type: none"> A menu is on the TV screen. 	<ul style="list-style-type: none"> Press the SET-UP button to turn off the menu screen.
	<ul style="list-style-type: none"> The Rating level is set. 	<ul style="list-style-type: none"> Cancel the Rating function or change the rating level.
Severe hum or noise is heard.	<ul style="list-style-type: none"> The plugs and jacks are dirty. 	<ul style="list-style-type: none"> Wipe them with a cloth slightly moistened with alcohol.
	<ul style="list-style-type: none"> The disc is dirty. 	<ul style="list-style-type: none"> Clean the disc.
	<ul style="list-style-type: none"> The speakers and components are connected poorly. 	<ul style="list-style-type: none"> Connect the speakers and components securely.
	<ul style="list-style-type: none"> The unit is located with too close to the TV. 	<ul style="list-style-type: none"> Move your TV away from the audio components.
Radio stations cannot be tuned in.	<ul style="list-style-type: none"> The antenna is positioned or connected poorly. 	<ul style="list-style-type: none"> Connect the antenna securely. Adjust the antennas and connect an external antenna if necessary.
	<ul style="list-style-type: none"> The signal strength of the stations is too weak (when tuning in with automatic tuning). 	<ul style="list-style-type: none"> Tune in the station manually.
	<ul style="list-style-type: none"> No stations have been preset or preset stations have been cleared (when tuning by scanning preset stations). 	<ul style="list-style-type: none"> Preset the stations.
The remote control does not work properly.	<ul style="list-style-type: none"> The remote control is not pointed at the remote sensor of the unit. 	<ul style="list-style-type: none"> Point the remote control at the remote sensor of the unit.
	<ul style="list-style-type: none"> The remote control is too far from the unit. 	<ul style="list-style-type: none"> Operate the remote control within about 23 ft (7 m).
	<ul style="list-style-type: none"> There is an obstacle in the path of the remote control and the unit. 	<ul style="list-style-type: none"> Remove the obstacle.
	<ul style="list-style-type: none"> The batteries in the remote control are exhausted. 	<ul style="list-style-type: none"> Replace the batteries with new ones.
The disc tray is not opened	<ul style="list-style-type: none"> The DVD/CD function is not selected. 	<ul style="list-style-type: none"> Select the DVD/CD function by pressing DVD button. And then press the OPEN/CLOSE button.

Language Code List

Use this list to input your desired language for the following initial settings:
Disc Audio, Disc Subtitle, Disc Menu.

Language	Code	Language	Code	Language	Code	Language	Code
Abkhazian	6566	Finnish	7073	Macedonian	7775	Slovenian	8376
Afar	6565	French	7082	Malagasy	7771	Somali	8379
Afrikaans	6570	Galician	7176	Malay	7783	Spanish	6983
Albanian	8381	Georgian	7565	Malayalam	7776	Sudanese	8385
Ameharic	6577	German	6869	Maltese	7784	Swahili	8387
Arabic	6582	Greek	6976	Maori	7773	Swedish	8386
Armenian	7289	Greenlandic	7576	Marathi	7782	Tagalog	8476
Assamese	6583	Guarani	7178	Moldavian	7779	Tajik	8471
Azerbaijani	6590	Gujarati	7185	Mongolian	7778	Tamil	8465
Bashkir	6665	Hausa	7265	Nauru	7865	Tatar	8484
Basque	6985	Hebrew	7387	Nepali	7869	Telugu	8469
Bengali; Bangla	6678	Hindi	7273	Norwegian	7879	Thai	8472
Bhutani	6890	Hungarian	7285	Oriya	7982	Tibetan	6679
Bihari	6672	Icelandic	7383	Panjabi	8065	Tigrinya	8473
Breton	6682	Indonesian	7378	Pashto, Pushto	8083	Tonga	8479
Bulgarian	6671	Interlingua	7365	Persian	7065	Turkish	8482
Burmese	7789	Irish	7165	Polish	8076	Turkmen	8475
Byelorussian	6669	Italian	7384	Portuguese	8084	Twi	8487
Cambodian	7577	Japanese	7465	Quechua	8185	Ukrainian	8575
Catalan	6765	Javanese	7487	Rhaeto-Romance	8277	Urdu	8582
Chinese	9072	Kannada	7578	Rumanian	8279	Uzbek	8590
Corsican	6779	Kashmiri	7583	Russian	8285	Vietnamese	8673
Croatian	7282	Kazakh	7575	Samoan	8377	Volapük	8679
Czech	6783	Kirghiz	7589	Sanskrit	8365	Welsh	6789
Danish	6865	Korean	7579	Scots Gaelic	7168	Wolof	8779
Dutch	7876	Kurdish	7585	Serbian	8382	Xhosa	8872
English	6978	Laothian	7679	Serbo-Croatian	8372	Yiddish	7473
Esperanto	6979	Latin	7665	Shona	8378	Yoruba	8979
Estonian	6984	Latvian, Lettish	7686	Sindhi	8368	Zulu	9085
Faroese	7079	Lingala	7678	Singhalese	8373		
Fiji	7074	Lithuanian	7684	Slovak	8375		

Area Code List

Choose an area code from this list.

Country	Code	Country	Code	Country	Code	Country	Code
Afghanistan	AF	Ethiopia	ET	Malaysia	MY	Saudi Arabia	SA
Argentina	AR	Fiji	FJ	Maldives	MV	Senegal	SN
Australia	AU	Finland	FI	Mexico	MX	Singapore	SG
Austria	AT	France	FR	Monaco	MC	Slovak Republic	SK
Belgium	BE	Germany	DE	Mongolia	MN	Slovenia	SI
Bhutan	BT	Great Britain	GB	Morocco	MA	South Africa	ZA
Bolivia	BO	Greece	GR	Nepal	NP	South Korea	KR
Brazil	BR	Greenland	GL	Netherlands	NL	Spain	ES
Cambodia	KH	Heard and McDonald Islands	HM	Dutch Antilles	AN	Sri Lanka	LK
Canada	CA	Hong Kong	HK	New Zealand	NZ	Sweden	SE
Chile	CL	Hungary	HU	Nigeria	NG	Switzerland	CH
China	CN	India	IN	Norway	NO	Taiwan	TW
Colombia	CO	Indonesia	ID	Oman	OM	Thailand	TH
Congo	CG	Israel	IL	Pakistan	PK	Turkey	TR
Costa Rica	CR	Italy	IT	Panama	PA	Uganda	UG
Croatia	HR	Jamaica	JM	Paraguay	PY	Ukraine	UA
Czech Republic	CZ	Japan	JP	Philippines	PH	United States	US
Denmark	DK	Kenya	KE	Poland	PL	Uruguay	UY
Ecuador	EC	Kuwait	KW	Portugal	PT	Uzbekistan	UZ
Egypt	EG	Libya	LY	Romania	RO	Vietnam	VN
El Salvador	SV	Luxembourg	LU	Russian Federation	RU	Zimbabwe	ZW

Specifications

General

Power supply	Refer to the main label.
Power consumption	70 W (LX-D2960A model) 50 W (LX-D2560A model)
Net Weight	5.9 kg
External dimensions (W x H x D)	190 X 352 X 295 mm

Tuner/Amplifier

FM Tuning Range	87.5 - 108.0 MHz or 65 -74 MHz, 87.5 -108.0 MHz
Intermediate Frequency	10.7 MHz
Signal to Noise Ratio	60/55 dB (Mono/Stereo)
Frequency Response	50 - 10000 Hz
AM Tuning Range	522 - 1620 kHz or 520 - 1720 kHz
Intermediate Frequency	450 kHz
Signal to Noise Ratio	30 dB
Frequency Response	140 - 1800 Hz
Output Power	Front: 100 W + 100 W (4 Ω , THD 10 %) - LX-D2960A model Front: 50 W + 50 W (4 Ω , THD 10 %) - LX-D2560A model
T.H.D	0.5 %
Frequency Response	40 - 20000 Hz
Signal-to-noise ratio	75 dB

DVD/VCD/CD player

Frequency response (audio)	40 - 20000 Hz
Signal-to-noise ratio (audio)	More than 75 dB (1 kHz)
Signal-to-noise ratio (video)	More than 55 dB (1 kHz)
Dynamic range (audio)	More than 80 dB
Video output	1.0 V (p-p), 75 Ω
S-video output	(Y) 1.0 V (p-p), 75 Ω (C) 0.3 V (p-p), 75 Ω
Component Video output	(Y) 1.0 V (p-p), 75 Ω (Pb)/(Pr) 0.7 V (p-p), 75 Ω

Cassette tape player

Tape Speed	3000 \pm 3 % (MTT-111, NORMAL-SPEED)
Wow Flutter	0.25 % (TT -111, JIS-WTD)
F.F/REW. Time	120 sec (C-60)
Frequency Response	250 - 8000 Hz
Signal to Noise Ratio	43 dB
Channel Separation	50 dB (P/B)/45 dB (R/P)
Erase Ratio	55 dB (MTT-5511)

Speakers

Speaker Name	Front Speaker (L/R)
Type	Bass Reflex 2Way 3Speaker (LXS-D2960V Model) Bass Reflex 2Way 2Speaker (LXS-D2560V Model)
Impedance	4 Ω
Frequency Response	60 - 20000 Hz
Sound Pressure Level	85 dB/W (1m)
Rated Input Power	100 W (LXS-D2960V) 50 W (LXS-D2560V)
Max. Input Power	200 W (LXS-D2960V) 100 W (LXS-D2560V)
Net Dimensions (W x H x D)	190 X 351 X 295 mm (LXS-D2960V) 190 X 351 X 270 mm (LXS-D2560V)
Net Weight	4.8 kg (LXS-D2960V) 4.2 kg (LXS-D2560V)