



PLASMA TV

OWNER'S MANUAL

MODELS: 50PY2DR 50PY2DR-UA
50PY2DRH 50PY2DRH-UA
60PY2DR 60PY2DR-UA
60PY2DRH 60PY2DRH-UA
50PX4DR 50PX4DR-UA
50PX4DRH 50PX4DRH-UA



Please read this manual carefully and completely before operating your TV.

Retain this manual for future reference.

Record model number and serial number of the TV in the spaces provided below.

See the label attached on the back cover and relate this information to your dealer if you require service.

Model Number :

Serial Number :

Warning/Caution



WARNING/CAUTION:

TO REDUCE THE RISK OF ELECTRIC SHOCK DO NOT REMOVE COVER (OR BACK). NO USER SERVICEABLE PARTS INSIDE. REFER TO QUALIFIED SERVICE PERSONNEL.



The lightning flash with arrowhead symbol, within an equilateral triangle, is intended to alert the user to the presence of uninsulated "dangerous voltage" within the product's enclosure that may be of sufficient magnitude to constitute a risk of electric shock to persons.



The exclamation point within an equilateral triangle is intended to alert the user to the presence of important operating and maintenance (servicing) instructions in the literature accompanying the appliance.

WARNING/CAUTION:

TO PREVENT FIRE OR SHOCK HAZARDS, DO NOT EXPOSE THIS PRODUCT TO RAIN OR MOISTURE.

FCC NOTICE

• A Class B digital device

This equipment has been tested and found to comply with the limits for a Class B digital device, pursuant to Part 15 of the FCC Rules. These limits are designed to provide reasonable protection against harmful interference in a residential installation. This equipment generates, uses and can radiate radio frequency energy and, if not installed and used in accordance with the instructions, may cause harmful interference to radio communications. However, there is no guarantee that interference will not occur in a particular installation. If this equipment does cause harmful interference to radio or television reception, which can be determined by turning the equipment off and on, the user is encouraged to try to correct the interference by one or more of the following measures:

- Reorient or relocate the receiving antenna.
- Increase the separation between the equipment and receiver.
- Connect the equipment into an outlet on a circuit different from that to which the receiver is connected.
- Consult the dealer or an experienced radio/TV technician for help.

• Any changes or modifications not expressly approved by the party responsible for compliance could void the user's authority to operate the equipment.

CAUTION:

Do not attempt to modify this product in any way without written authorization from LG Electronics. Unauthorized modification could void the user's authority to operate this product

COMPLIANCE:

The responsible party for this product's compliance is:

LG Electronics U.S.A., Inc
1000 Sylvan Avenue, Englewood Cliffs, NJ 07632
1-800-243-0000
<http://www.lgusa.com>

WARNING/CAUTION

TO REDUCE THE RISK OF FIRE AND ELECTRIC SHOCK, DO NOT EXPOSE THIS PRODUCT TO RAIN OR MOISTURE.

TV Guide On Screen Notices for U.S.A.

Trademark Notice

In the United States, TV GUIDE and other related marks are registered marks of Gemstar-TV Guide International, Inc. and/or one of its affiliates. In Canada, TV GUIDE is a registered mark of Transcontinental Inc., and is used under license by Gemstar-TV Guide International, Inc.

Aux Etats Unis TV GUIDE et d'autres marques relatives sont des marques déposées de Gemstar-TV Guide International, Inc. et/ou d'une de ses sociétés affiliées. Au Canada TV GUIDE est une marque déposée de Transcontinental Inc., utilisée sous licence de Gemstar-TV Guide International, Inc.

License Notice

The TV Guide On Screen system is manufactured under license from Gemstar-TV Guide International, Inc. and/or one of its affiliates.

Le système TV Guide On Screen est fabriqué sous licence de Gemstar-TV Guide International, Inc. et/ou d'une de ses sociétés affiliées.

Patent Notice

The TV Guide On Screen system is protected by one or more of the following issued United States patents 6,498,895, 6,418,556, 6,331,877; 6,239,794; 6,154,203; 5,940,073; 4,908,713; 4,751,578; 4,706,121.

Le système TV Guide On Screen est protégé par un ou plusieurs brevets émis aux Etats Unis, comme le 6,498,895, 6,418,556, 6,331,877; 6,239,794; 6,154,203; 5,940,073; 4,908,713; 4,751,578; 4,706,121.

Use of the CableCARD™ TradeMark.

"CableCARD™ is a trademark of Cable Television Laboratories, Inc."

Digital Cable Compatibility

This digital television is capable of receiving basic analog, digital basic and digital premium cable television programming by direct connection to a cable system providing such programming. A security card provided by your cable operator is required to view encrypted digital programming. Cable operator enhanced program (For example, electronic program guide provided by the cable operator), and data enhanced television service may require the use of a set top box. For more information contact your local cable operator.

Safety Instructions

IMPORTANT SAFETY INSTRUCTIONS

Important safety instructions shall be provided with each apparatus. This information shall be given in a separate booklet or sheet, or be located before any operating instructions in an instruction for installation for use and supplied with the apparatus.

This information shall be given in a language acceptable to the country where the apparatus is intended to be used.

The important safety instructions shall be entitled "Important Safety Instructions". The following safety instructions shall be included where applicable, and, when used, shall be verbatim as follows. Additional safety information may be included by adding statements after the end of the following safety instruction list. At the manufacturer's option, a picture or drawing that illustrates the intent of a specific safety instruction may be placed immediately adjacent to that safety instruction :

1. **Read these instructions.**
2. **Keep these instructions.**
3. **Heed all warnings.**
4. **Follow all instructions.**
5. **Do not use this apparatus near water.**
6. **Clean only with dry cloth.**
7. **Do not block any ventilation openings. Install in accordance with the manufacturer's instructions.**
8. **Do not install near any heat sources such as radiators, heat registers, stoves, or other apparatus (including amplifiers) that produce heat.**
9. **Do not defeat the safety purpose of the polarized or grounding-type plug. A polarized plug has two blades with one wider than the other. A grounding type plug has two blades and a third grounding prong. The wide blade or the third prong are provided for your safety. If the provided plug does not fit into your outlet, consult an electrician for replacement of the obsolete outlet.**
10. **Protect the power cord from being walked on or pinched particularly at plugs, convenience receptacles, and the point where they exit from the apparatus.**
11. **Only use attachments/accessories specified by the manufacturer.**
12. **Use only with the cart, stand, tripod, bracket, or table specified by the manufacturer, or sold with the apparatus. When a cart is used, use caution when moving the cart/apparatus combination to avoid injury from tip-over.**



PORTABLE CART WARNING

13. Unplug this apparatus during lightning storms or when unused for long periods of time.

14. Refer all servicing to qualified service personnel. Servicing is required when the apparatus has been damaged in any way, such as power-supply cord or plug is damaged, liquid has been spilled or objects have fallen into the apparatus, the apparatus has exposed to rain or moisture, does not operate normally, or has been dropped.

15. CAUTION concerning the Power Cord :

Most appliances recommend they be placed upon a dedicated circuit; that is, a single outlet circuit which powers only that appliance and has no additional outlets or branch circuits. Check the specification page of this owner's manual to be certain.

Do not overload wall outlets. Overloaded wall outlets, loose or damaged wall outlets, extension cords, frayed power cords, or damaged or cracked wire insulation are dangerous. Any of these conditions could result in electric shock or fire. Periodically examine the cord of your appliance, and if its appearance indicates damage or deterioration, unplug it, discontinue use of the appliance, and have the cord replaced with an exact replacement part by an authorized servicer.

Protect the power cord from physical or mechanical abuse, such as being twisted, kinked, pinched, closed in a door, or walked upon. Pay particular attention to plugs, wall outlets, and the point where the cord exits the appliance.

16. Outdoor Use Marking :

WARNING - To Reduce The Risk Of Fire Or Electric Shock, Do Not Expose This Appliance To Rain Or Moisture.

17. Wet Location Marking :

Apparatus shall not be exposed to dripping or splashing and no objects filled with liquids, such as vases, shall be placed on the apparatus.

18. Any DATA saved on HDD may be lost or damaged, making a back up copy of data is strongly recommended. The manufacturer will NOT be responsible for any data loss or damage.

Contents

Warning/Caution2
 Digital Cable Compatibility3
 Safety Instructions4~5

Introduction

Controls/Connection Options8~11
 Remote Control Key Functions12~13

Installation

Accessories14
 Installation Instructions
 Joining the TV assembly to the wall to protect the set tumbling14
 Install the RING SPACER with the bolts on the set as shown15
 Remove or Attache the Plate Cover17
 Swivel function18
 Arrangement wires18
 External Equipment Connections19~25
 Antenna or Cable Connection19~20
 VCR Setup20
 External A/V Source Setup21
 DVD Setup21
 CableCARD™ Setup22
 HDSTB Setup22
 PC Setup23~24
 Monitor Out Setup25
 Digital Audio Output25
 HDMI26~28
 TV Guide On Screen Setup29~35

Operation

Turning the TV On36
 HOME Menu37
 TV Setup38~56
 On-screen Menus Language Selection38
 Setup Menu Options
 EZ Scan (Channel Search)39
 Manual Scan39
 Channel Edit40
 DTV Signal Strength40
 Channel Label Setup41
 Main Picture Source Selection41
 Input Label41
 Video Menu Options
 EZ Picture42
 Manual Picture Control (Custom Option)42
 Color Temperature Control42
 Video Reset42
 Audio Menu Options
 Audio Language43
 EZ SoundRite / EZ Sound43
 Manual Sound Control (custom Option)44
 Front Surround44
 TV Speakers On/Off Setup45
 Stereo/SAP Broadcasts Setup45
 BBE45
 Time Menu Options
 Auto Clock Setup46
 Manual Clock Setup46

On/Off Timer Setup46
 Sleep Timer / Auto Off47
 Option Menu Features
 Advanced48
 Cinema 3:2 Mode Setup48
 Low Power48
 LG Logo49
 Aspect Ratio Control50
 Caption51
 Caption / Text51
 Caption Option52
 ISM Method53
 Front Display53
 Auto Demo54
 Lock Menu Options
 Parental Lock Setup56
 CableCARD™ Function
 Cable menu options57
 Scrambled channel57
 Cable Channel List58
 Emergency Alert Message58
XStudio
 Recorded TV59~63
 Notes on Memory Card64~67
 Photo List68~69
 Music List70~72
 Timeshift73~74
 Recording75~77
TV Guide On Screen™ System78~98
IEEE 139499~110
 Remote Control
 PIP (Picture-in-Picture)/POP/Twin Picture
 Watching PIP/POP/Twin Picture111
 Selecting an Input Signal Source for PIP/Twin Picture111
 Swapping PIP/Twin Picture111
 TV Program Selection for PIP111
 Moving the PIP sub picture112
 Adjusting Main and Sub Picture Sizes for Twin Picture112
 POP (Picture-out-of-Picture: Channel Scan)112
 APM113
 Bried Info.114
 EZ Mute115
 Screen Setup for PC mode116

External Control Device Setup117~122

IR Codes123~124

Programming the Remote125

Programming Codes126~127

Troubleshooting Checklist128

Maintenance129

Product Specifications130

Warranty131~132

After reading this manual, keep it handy for future reference.

Introduction

What is a Plasma Display Panel (PDP)?

A plasma display panel is the latest display technology and the best way to achieve flat panel displays with excellent image quality and large screen sizes that are easily viewable. The PDP can be thought of as a descendant of the neon lamp and it can be also be viewed as a series of fluorescent lamps.

How does it work?

PDP is an array of cells, known as pixels, which are comprised of 3 sub pixels, corresponding to the colors red, green, and blue. Gas in a plasma state is used to react with phosphors in each sub-pixel to produce colored light (red, green, or blue). These phosphors are the same types used in Cathode Ray Tube (CRT) devices such as televisions and common computer monitors.

You get the rich, dynamic colors that you expect. Each sub-pixel is individually controlled by advanced electronics to produce over 16 million different colors. All of these mean that you get perfect images that are easily viewable in a display that is less than 5 inches thick.

160° - Wide angle range of vision

Your flat panel plasma screen offers an exceptionally broad viewing angle -- over 160 degrees. This means that the display is clear and visible to viewers anywhere in the room who can see the screen.

Wide Screen

The screen of the Plasma Display is so wide that your viewing experience is as if you are in a theater.

Multimedia

Connect your plasma display to a PC and you can use it for conferencing, games, and Internet browsing. The Picture-in-Picture feature allows you to view your PC and video images simultaneously.

Versatile

The light weight and thin size makes it easy to install your plasma display in a variety of locations where conventional TVs will not fit.

The PDP Manufacturing Process: a few minute colored dots may be present on the PDP screen

The PDP (Plasma Display Panel), which is the display device of this product, is composed of 0.9 to 2.2 million cells. A few cell defects will normally occur in the PDP manufacturing process. Several tiny, minute colored dots visible on the screen should be acceptable. This also occurs in other PDP manufacturers' products. The tiny dots appearing does not mean that this PDP is defective. Thus a few cell defects are not sufficient cause for the PDP to be exchanged or returned. Our production technology minimizes these cell defects during the manufacture and operation of this product.

Cooling Fan Noise

In the same way that a fan is used in a PC computer to keep the CPU (Central Processing Unit) cool, the PDP is equipped with cooling fans to cool the Monitor and improve its reliability. Therefore, a certain level of noise could occur while the fans are operating and cooling the PDP.

The fan noise doesn't have any negative effect on the PDP's efficiency or reliability. The noise from these fans is normal during the operation of this product. We hope you understand that a certain level of noise from the cooling fans is acceptable and is not sufficient cause for the PDP to be exchanged or returned.

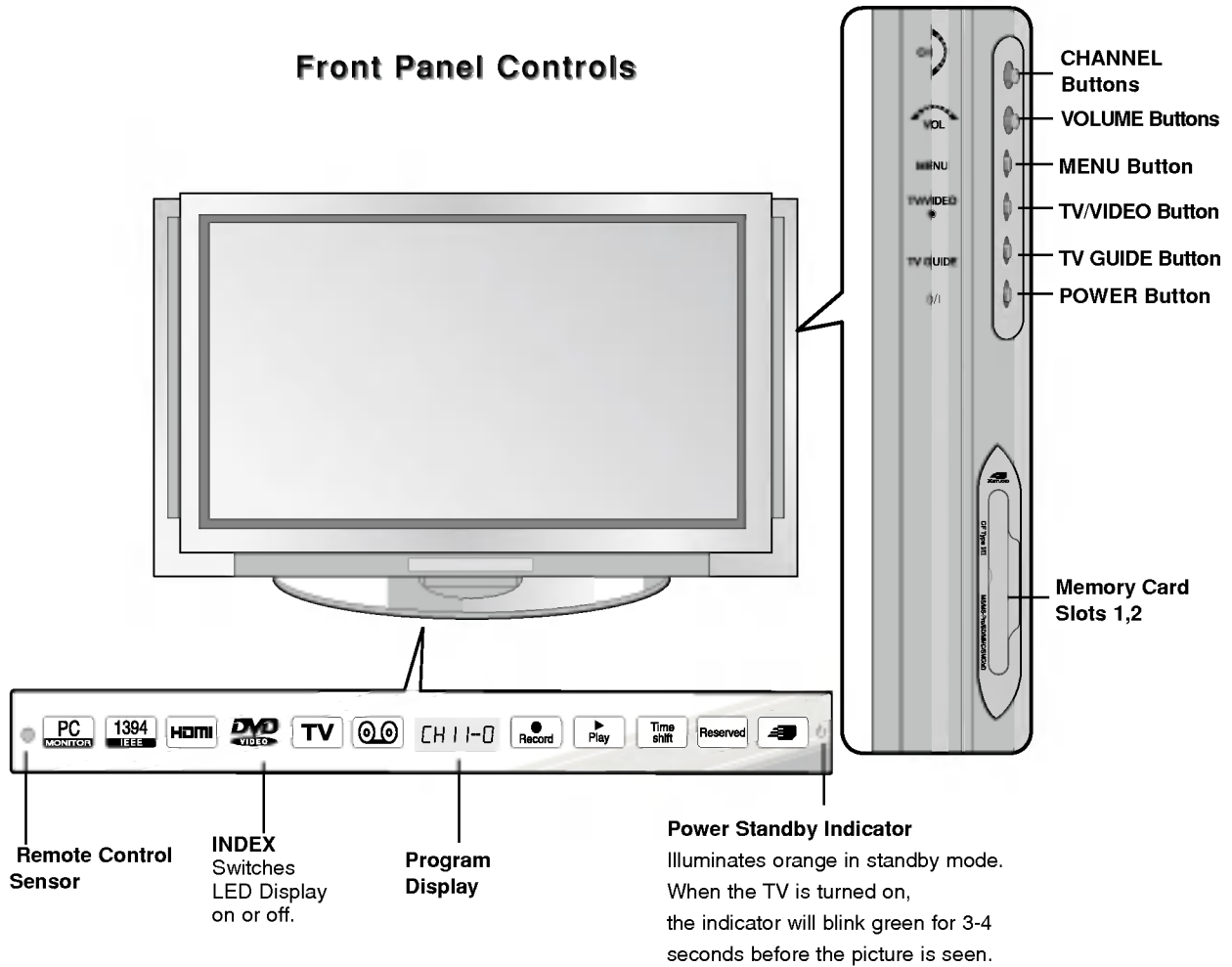
Controls

◆ This is a front panel of 50PY2DR, 50PY2DRH, 60PY2DR, 60PY2DRH series TVs.

- This is a simplified representation of a front panel.

Here shown may be somewhat different from your TV.

- This manual explains the features available on the 50PY2DR, 50PY2DRH, 60PY2DR, 60PY2DRH series TVs.

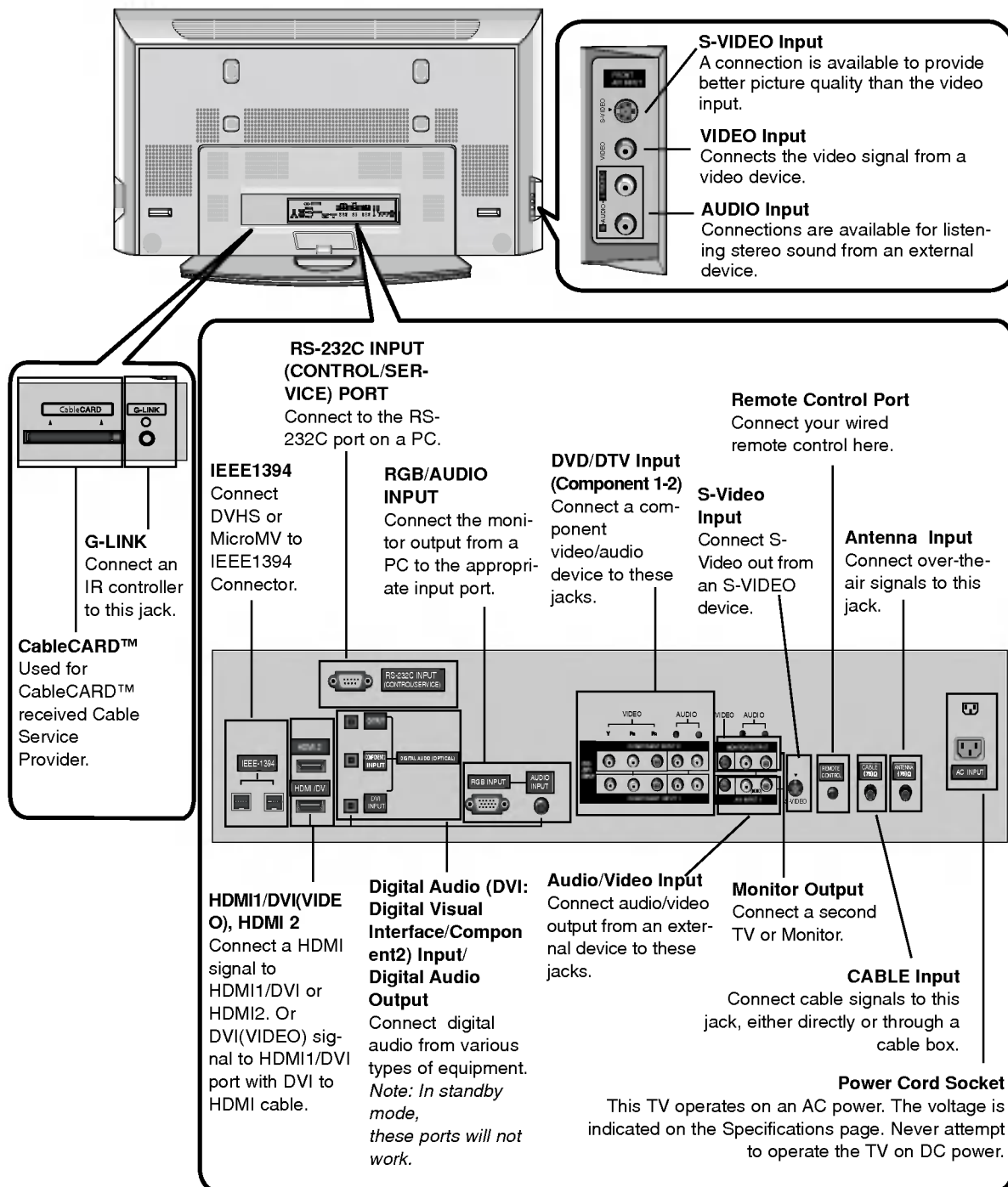


	RGB-PC(or RGB-DTV) mode		On recording
	IEEE1394 mode		On playing
	HDMI1/DVI or HDMI2 mode		On operating the TimeShift
	Component1 or 2 mode		State of setting the reserve record
	Antenna or Cable mode		On operating the Xstudio mode
	Video or Front Video mode		

Connection Options

◆ This is a back panel of 50PY2DR, 50PY2DRH, 60PY2DR, 60PY2DRH series TVs.

Back Connection Panel



Note:

- After removing the cover, you can insert the CableCARD™ or connect to the G-LINK jack.

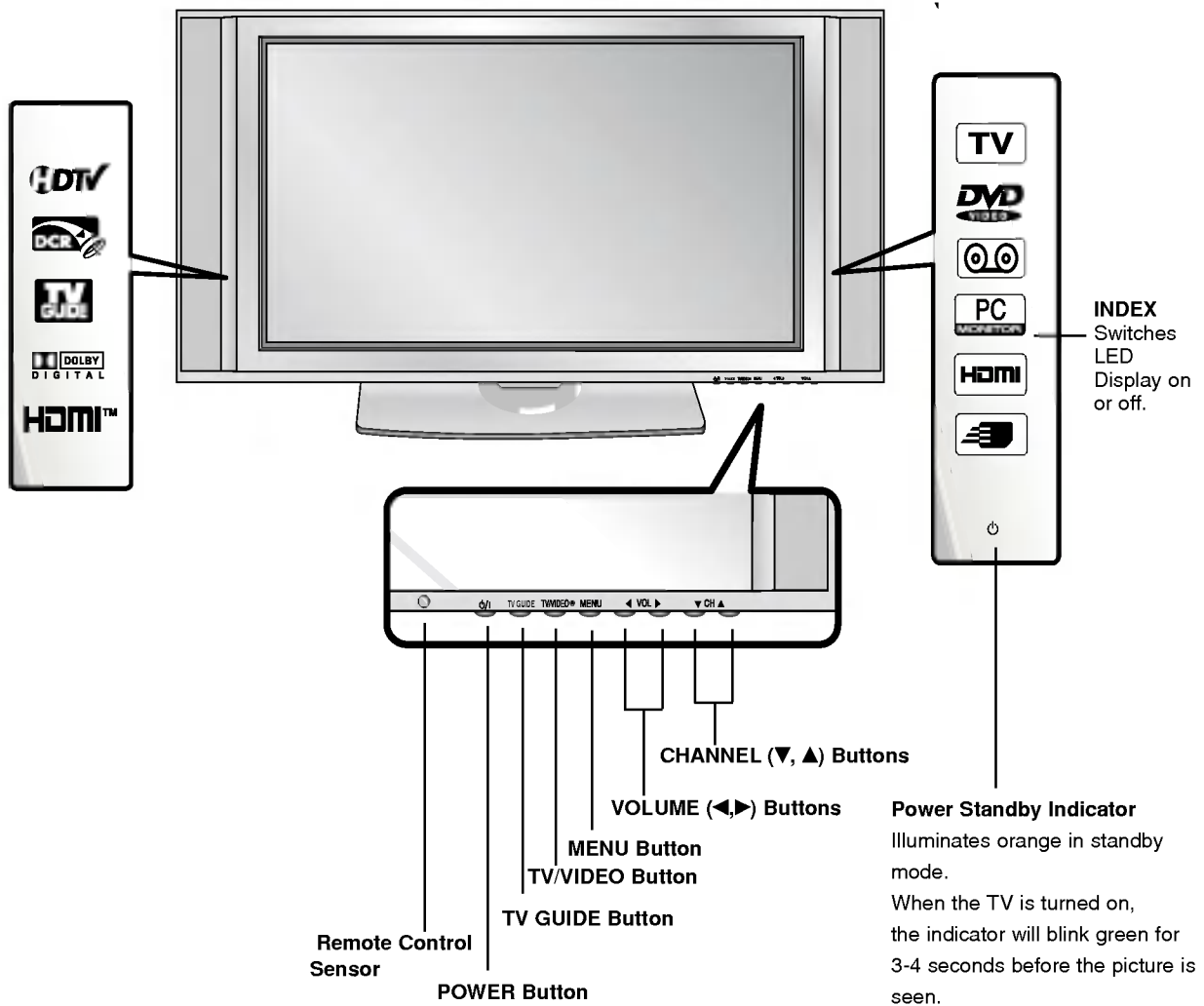
Controls

◆ This is a front panel of 50PX4DR, 50PX4DRH series TVs.

- This is a simplified representation of front panel.

Here shown may be somewhat different from your TV.

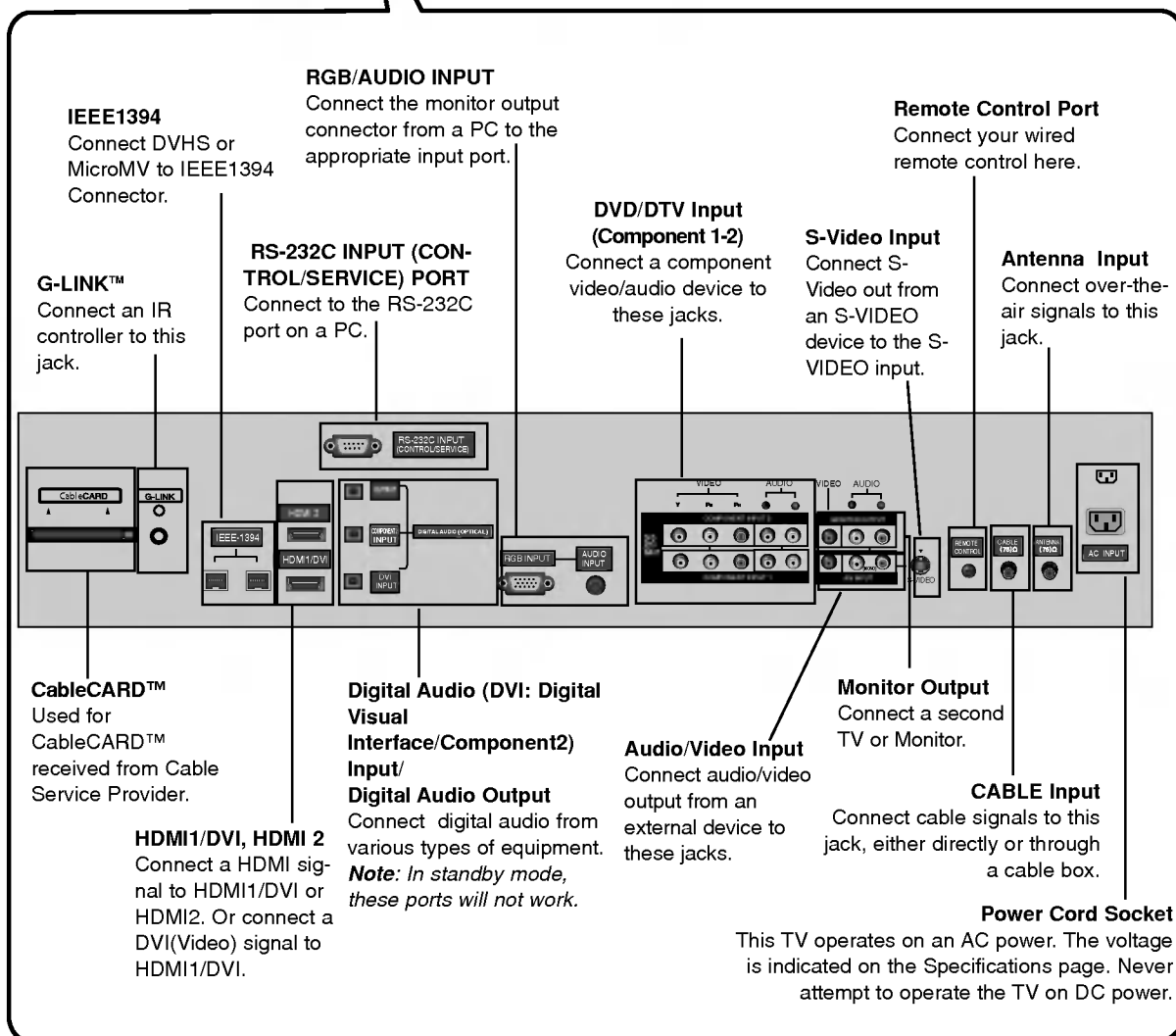
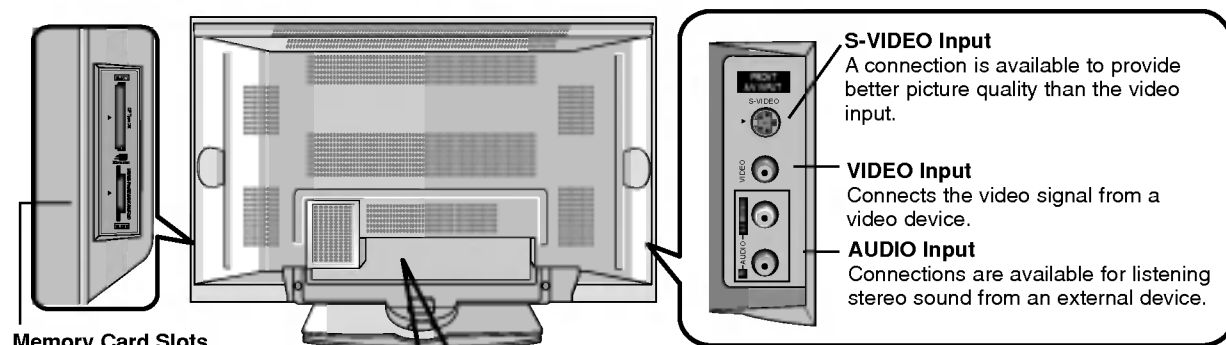
Front Panel Controls



Connection Options

◆ This is a back panel of 50PX4DR, 50PX4DRH series TVs.

Back Connection Panel



Remote Control Key Functions

- When using the remote control, aim it at the remote control sensor on the TV.

POWER
Turns your TV or any other programmed equipment on or off, depending on mode.

XSTUDIO PRO
Bring up the HOME menu to the screen.

THUMBSTICK (Up/Down/Left/Right/ENTER)
Allows you to navigate the on-screen menus and adjust the system settings to your preference.

REC LIST
Appear the thumbnail recorded list.

VOLUME UP/DOWN
Increases/decreases the sound level.

RATIO
Changes the aspect ratio.

SAP
Selects MTS sound: Mono, Stereo, and SAP in Analog mode. Change the audio language in DTV mode.

CC
Select a closed caption: Off, CC1~4, Text1~4.

M/C EJECT
Remove the Memory Card.

POWER
Turns your TV or any other programmed equipment on or off, depending on mode.

XSTUDIO PRO /VCR/DVD control buttons

- Use for DVR record or trick play. (Refer to p.61, 74)
- Use for Photo mode or Music mode of XSTUDIO PRO. (Refer to p.69, 72)
- Controls the DVHS or Camcorder in IEEE 1394 mode.
- Controls some video cassette recorders or DVD players when you have already selected DVD or VCR mode button.

DAY+/DAY-
Moves the Listings Grid forward or backward in 24 hour increments.

CHANNEL UP/DOWN
Selects available channels found during Manual scan.

PAGE UP/PAGE DOWN
Moves from one full set of screen information to the next one.

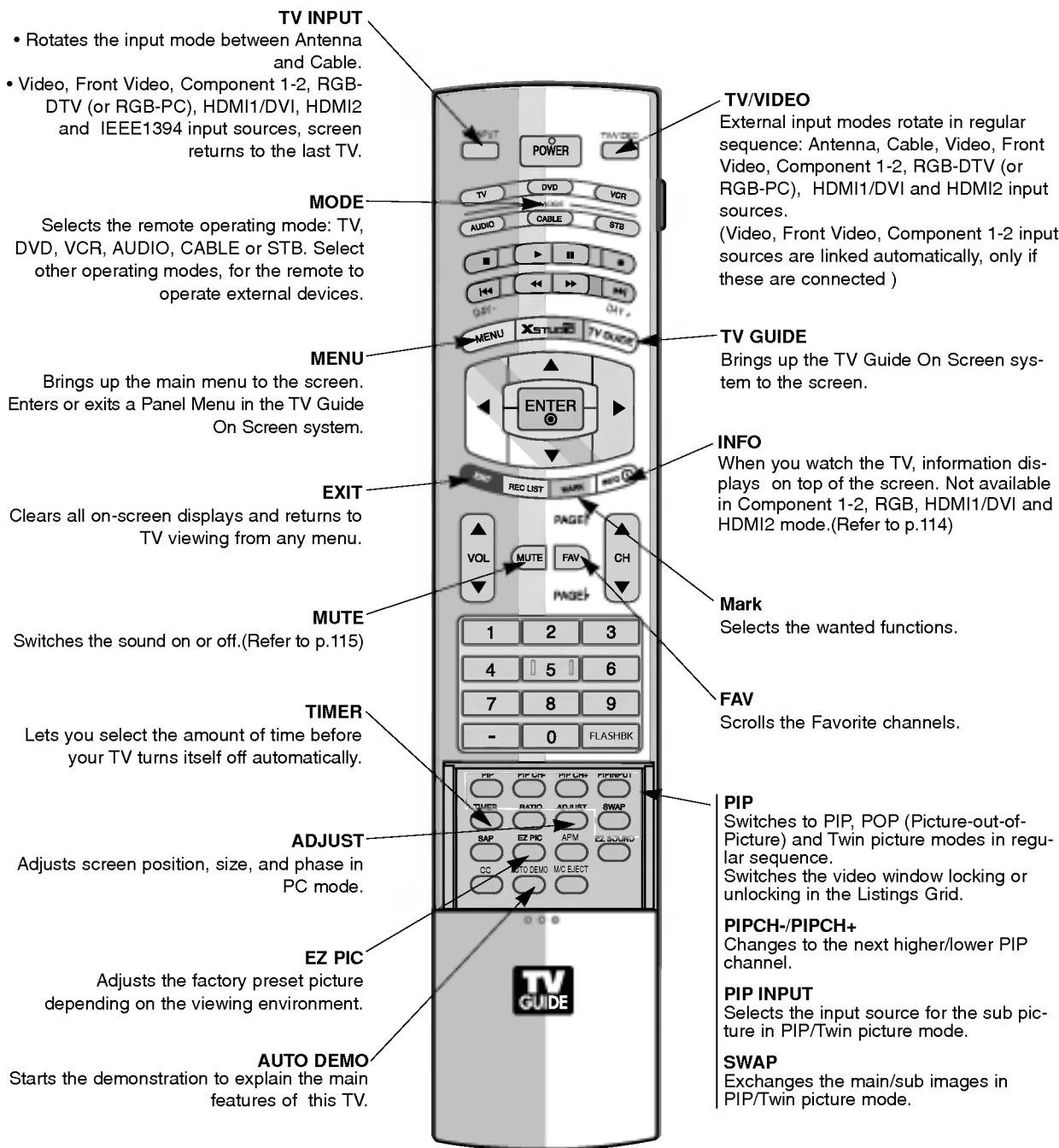
NUMBER buttons

FLASHBK
Tunes to the last channel viewed.

EZ SOUND
Selects the sound appropriate for the program's character.

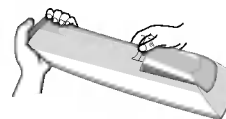
APM (Adaptive Picture Mode)
Concurrently, compare with the Daylight, Normal, Night Time and Custom on the screen. (Refer to p.113)

LIGHT
Illuminates the remote control buttons of selected mode.



Installing Batteries

- Open the battery compartment cover on the back side and install the batteries matching correct polarity (+ with +, - with -).
- Install two 1.5V AA batteries. Don't mix old or used batteries with new ones. Close cover.

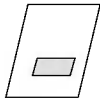


Installation

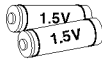
Accessories

Ensure that the following accessories are included with your TV. If any accessory is missing, please contact the dealer from where you purchased the product.

User must use shielded signal interface cables(D-sub 15 pin cable) with ferrite cores to maintain standard compliance for the product.



Owner's Manual



Batteries



Remote Control



Power Cord



75Ω Round Cable



2-Wall brackets(50'')



2-eye-bolts(50'')



G-LINK Cable



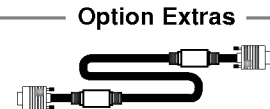
6-RING SPACER
(Only 60PY2DR/60PY2DRH series)



6- bolts
(Only 60PY2DR/60PY2DRH series)



2-Wall brackets(60'')
2-TV brackets(60'')



Option Extras

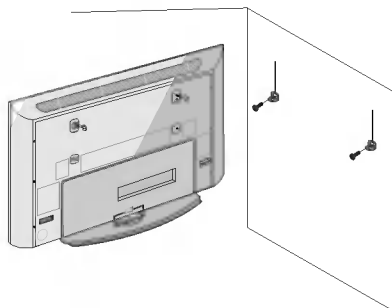
D-sub 15 pin cable

Installation Instructions

Joining the TV assembly to the wall to protect the set tumbling

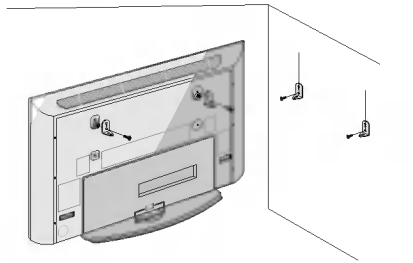
- Secure the TV assembly by joining it to a wall by using the TV/Wall brackets.
- Here shown may be somewhat different from your TV.

50PY2DR/50PY2DRH



- If the set will be mounted on a desk top, insert the 2 eye-bolts and tighten them securely in the upper holes as shown. Install the wall brackets on the wall with 2 bolts*, (not supplied with the product), as shown. Match the height of the eye-bolts and the wall brackets. Check to be sure the eye-bolts and the brackets are tightened securely.

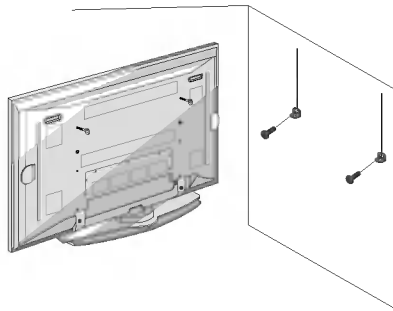
60PY2DR/60PY2DRH



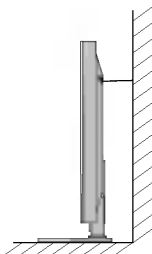
- If the set will be mounted on a desk top, install the 2 ring spacer on the TV.
And then install the TV brackets on the ring spacer as shown. Insert the 2 bolts and tighten securely, in the upper holes on the brackets.
Install the wall brackets on the wall with 2 bolts*, (not supplied with the product).
Match the height of the TV brackets and the wall brackets. Check to be sure the brackets are tightened securely.

Note: Bolts and RING SPACER commonly use for fixing the TV bracket or connecting the wall mounting bracket.

50PX4DR/50PX4DRH

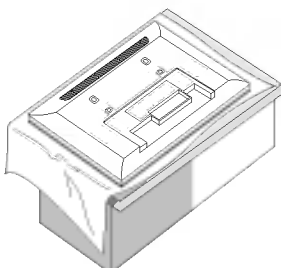


- If the set will be mounted on a desk top, insert the 2 eye-bolts and tighten them securely in the upper holes as shown.
Install the wall brackets on the wall with 2 bolts*, (not supplied with the product), as shown.
Match the height of the eye-bolts and the wall brackets. Check to be sure the eye-bolts and the brackets are tightened securely.

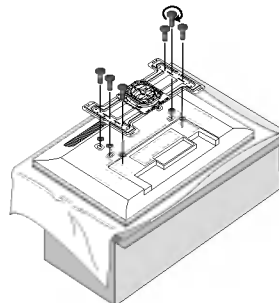


- Secure the TV assembly to the wall with strong strings or wire cables, (not supplied with the product), as shown.

Install the RING SPACER with the bolts on the set as shown. (Only 60PY2DR/60PY2DRH series)



1. Put the RING SPACER in the holes of the bolts before connecting to the wall mounting bracket.



2. When you connect the wall mounting bracket to the set, connect to it by using the 6-bolts, (supplied with the product), as shown.

Note: Bolts and RING SPACER commonly use for fixing the TV bracket or connecting the wall mounting bracket.

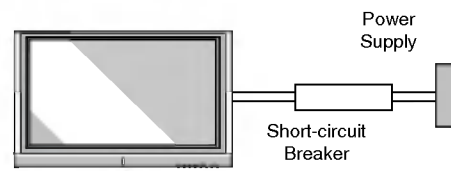
Installation Instructions

- The TV can be installed in various ways such as on a desktop etc.
- The TV is designed to be mounted horizontally.
- It is recommended that 50PY2DR, 60PY2DR, 50PX4DR model only be used at an altitude of less than 3281 feet (1000m) to get the best quality picture and sound.
- It is recommended that 50PY2DRH, 60PY2DRH, 50PX4DRH model only be used at an altitude of less than 6561 feet (2000m) to get the best quality picture and sound.

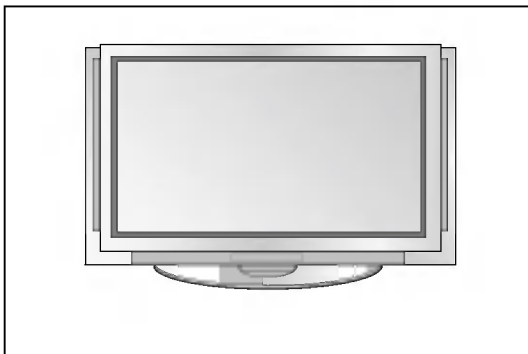
- This manual explains the features available on the 50PY2DR, 50PY2DRH, 60PY2DR, 60PY2DRH series TVs.
- Here shown may be somewhat different from your TV.

GROUNDING

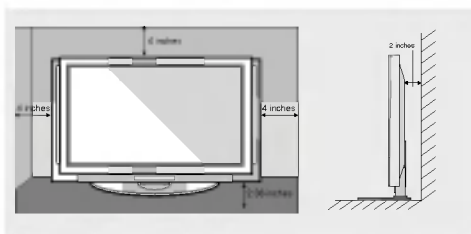
Ensure that you connect the earth ground wire to prevent possible electric shock. If grounding methods are not possible, have a qualified electrician install a separate circuit breaker. Do not try to ground the unit by connecting it to telephone wires, lightening rods, or gas pipes.



Desktop Pedestal Installation



For proper ventilation, allow a clearance of 4" on each side and the top, 2.36" on the bottom, and 2" from the wall. Detailed installation instructions are included in the optional Desktop Stand Installation.

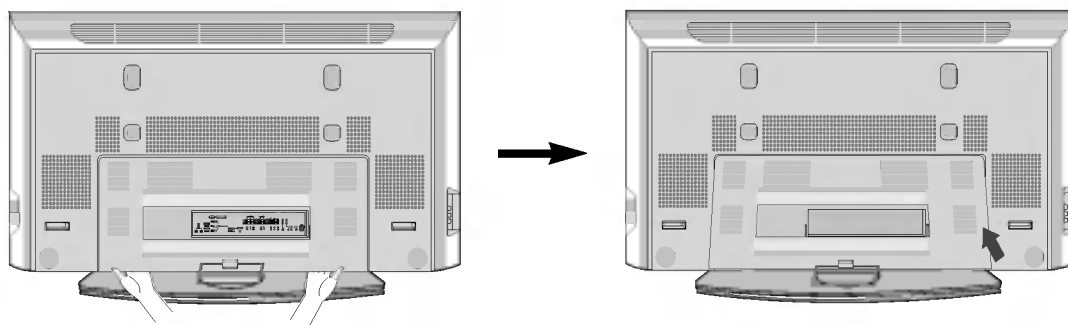


To Install on a Desktop

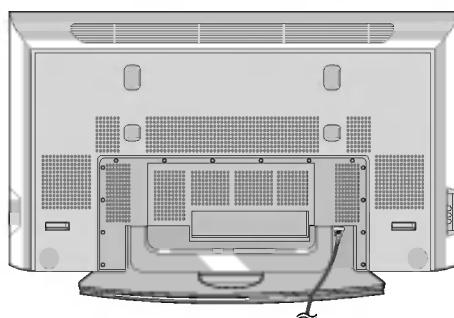
Pedestal mount minimum allowable clearances for adequate ventilation.

Remove or Attache the Plate Cover (Only 50/60PY2DR, 50/60PY2DRH series)

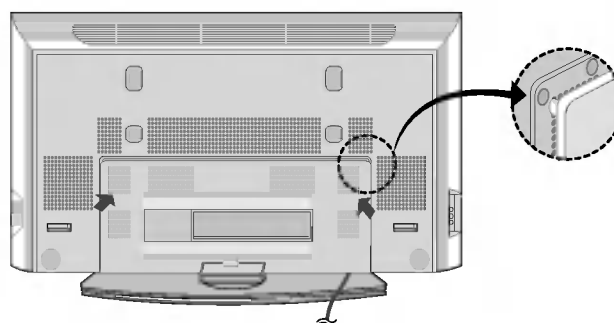
- This function explains the features available on the 50PY2DR, 50PY2DRH, 60PY2DR, 60PY2DRH series TVs.
- When moving or connecting the power cord, be used the these methods.
- And after removing the plate cover, you must install the wall brackets on the wall.



1. With hands, push the lower left/right of plate cover and then pull out to the front.



2. Connect the power cord on the TV's back.



3. In attaching the plate cover, align the guide to the bushings and press the cover in place with your hand.

Installation Instructions

Swivel function

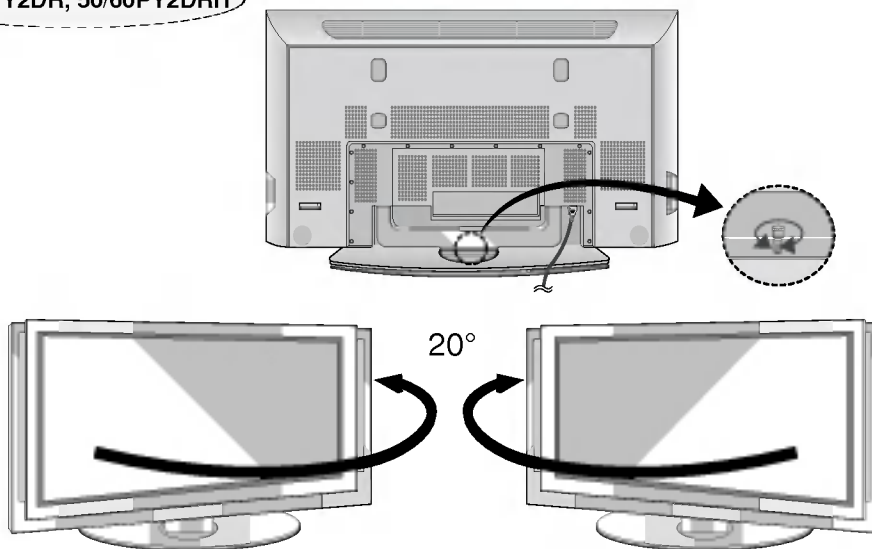
- This function explains the features available on the 50/60PY2DR, 50/60PY2DRH series TVs.

- After installing the TV, you can adjust the the TV set manually turning it to the left or right direction by 20 degrees to suit your viewing position.

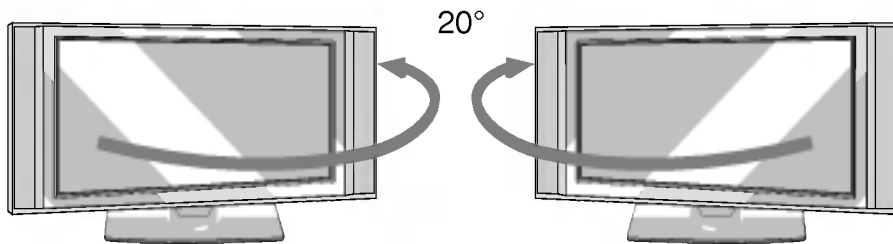
Note: Before adjusting the angle, you must loosen (to the left) the shaft bolt on the middle of stand's back.

And when you acheve the desired position, you must close the shaft bolt to set the hole.(As shown below)

50/60PY2DR, 50/60PY2DRH



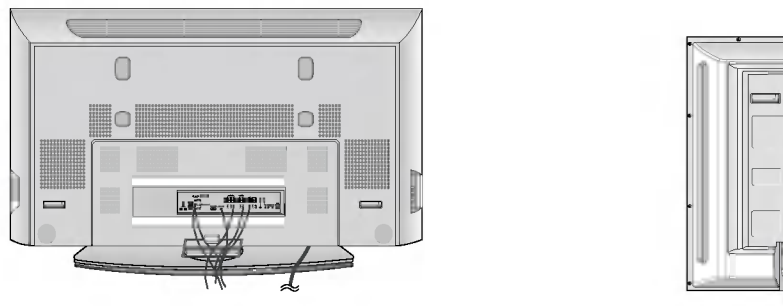
50PX4DR/50PX4DRH



Arrangement wires (Only 50/60PY2DR, 50/60PY2DRH series)

- This function explains the features available on the 50/60PY2DR, 50/60PY2DRH series TVs.

- Run the accessory device wires inside the JACK MANAGEMENT pole as shown.

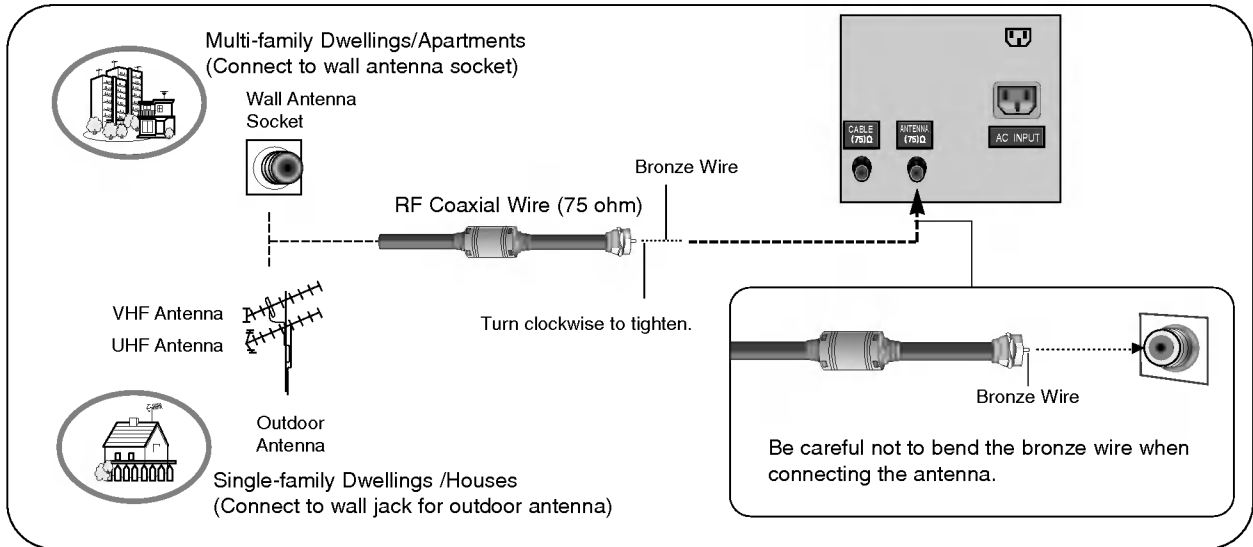


External Equipment Connections

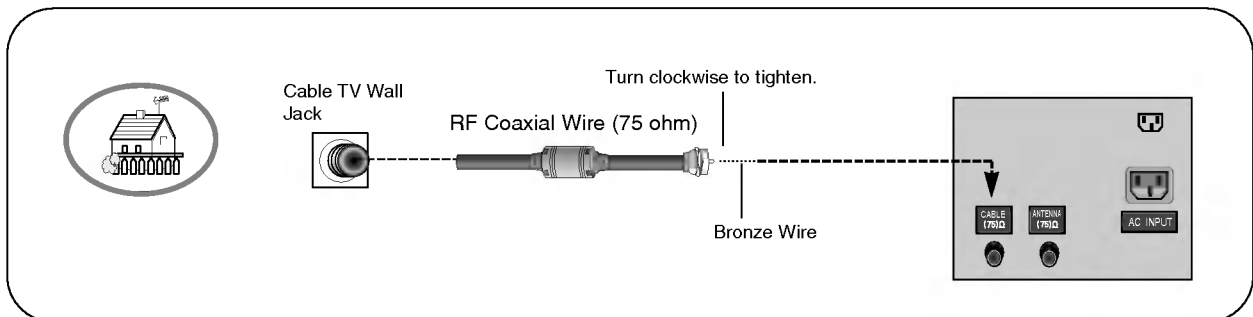
Antenna or Cable Connection

1. Analog and Digital TV signals provided on antenna

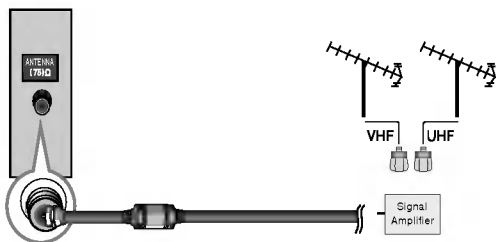
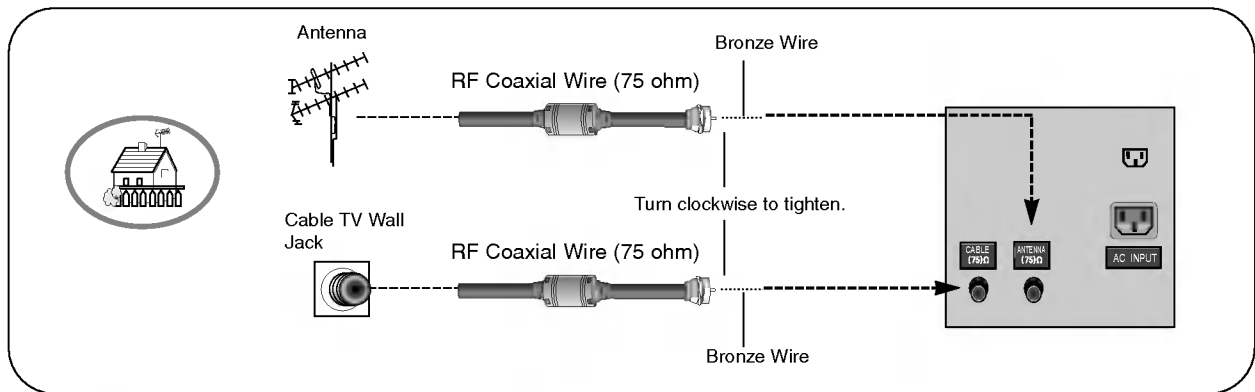
- Wall Antenna Socket or Outdoor Antenna without a Cable Box Connections
- For optimum picture quality, adjust antenna direction if needed.



2. Analog and Digital TV signals provided on cable



3. Analog and Digital TV signals provided on cable and antenna



- To improve the picture quality in a poor signal area, please purchase a signal amplifier and install properly.
- If the antenna needs to be split for two TV's, install a "2-Way Signal Splitter" in the connections.
- If the antenna is not installed properly, contact your dealer for assistance.

Note: The TV will let you know when the analog, cable, and digital channel scans are complete.

VCR Setup

- To avoid picture noise (interference), leave an adequate distance between the VCR and TV
- Use the ISM Method (on the Option menu) feature to avoid having a fixed image remain on the screen for a long period of time. If the 4:3 picture format is used; the fixed images on the sides of the screen may remain visible on the screen.

Connection Option 1

Set VCR output switch to 3 or 4 and then tune TV to the same channel number.

Connection Option 2

1. Connect the audio and video cables from the VCR's output jacks to the TV input jacks, as shown in the figure.

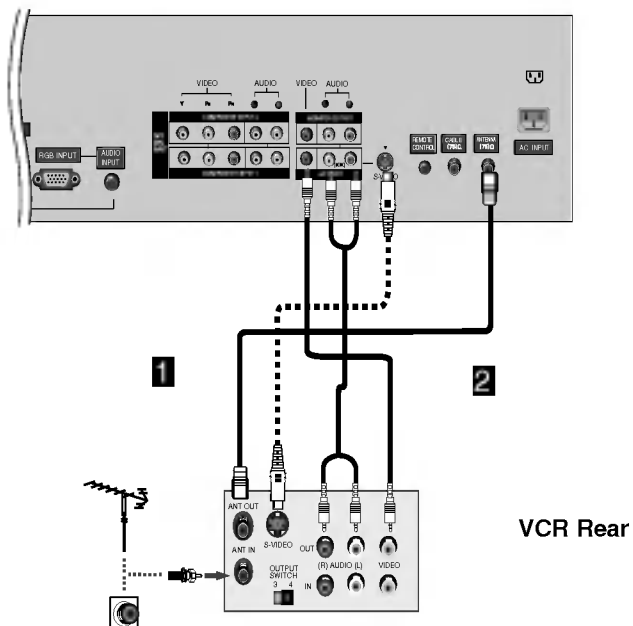
When connecting the TV to VCR, match the jack colors (Video = yellow, Audio Left = white, and Audio Right = red).

If you connect an S-VIDEO output from VCR to the S-VIDEO input, the picture quality is improved; compared to connecting a regular VCR to the Video input.

2. Insert a video tape into the VCR and press PLAY on the VCR. (Refer to the VCR owner's manual.)
3. Select the input source with using the TV/VIDEO button on the remote control. (If connected to A/V INPUT, select Video input source)



Do not connect to both Video and S-Video at the same time.



External A/V Source Setup

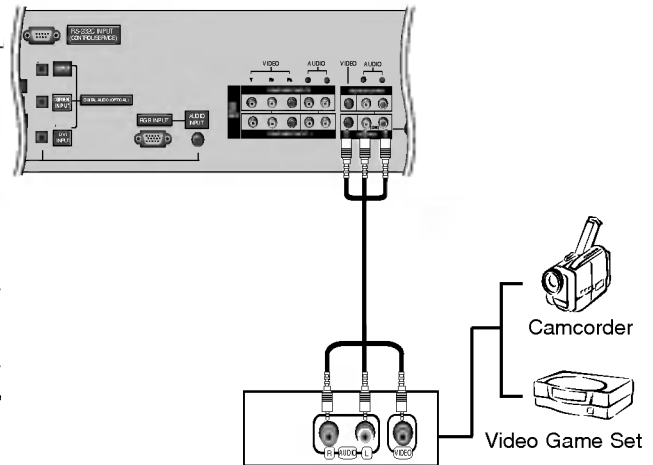
How to connect

Connect the audio and video cables from the external equipment's output jacks to the TV input jacks, as shown in the figure.

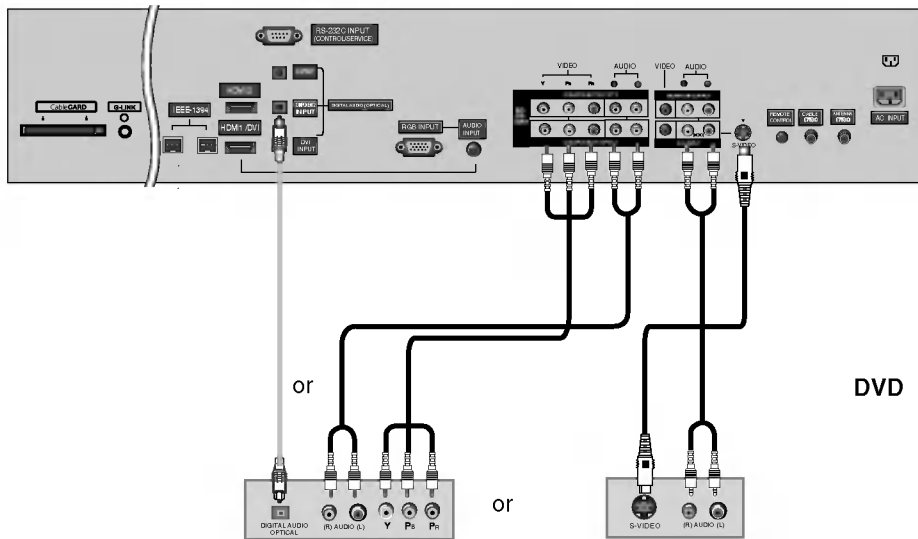
When connecting the TV to external equipment, match the jack colors (Video = yellow, Audio Left = white, and Audio Right = red).

How to use

1. Select the input source with using the **TV/VIDEO** button on the remote control. Note that this TV finds the connected input sources automatically for Video 1-2 and Component 1-2. It is presumed that RGB, HDMI1/DVI and HDMI2 sources are connected.
2. Operate the corresponding external equipment. For connection instructions to operate the TV Guide On Screen system, see page 29.



DVD Setup



How to connect

1. Connect the DVD video outputs (Y, P_B, P_R) to the COMPONENT (Y, P_B, P_R) INPUT jacks on the TV and connect the DVD audio outputs to the AUDIO INPUT jacks on the TV, as shown in the figure.
2. If your DVD only has an S-Video output jack, connect this to the S-VIDEO input on the TV and connect the DVD audio outputs to the AUDIO INPUT jacks on the TV, as shown in the figure.

Note: If your DVD player does not provide component video output, use S-Video output.

How to use

1. Turn on the DVD player and then insert a DVD.
2. Use the **TV/VIDEO** button on the remote control to select **Component 1** or **Component 2**. (If connected to S-VIDEO, select the **Video** or **Front Video** external input source.)
3. Refer to the DVD player's manual for operating instructions.

• Component input ports

To get better picture quality, connect a DVD player to the component input ports as shown below.

Component ports on the TV	Y	P _B	P _R
Video output ports on DVD player	Y	P _B	P _R
	Y	B-Y	R-Y
	Y	Cb	Cr
	Y	P _B	P _R

Notes:

- Digital Audio will not work for Component 1 input source.
- Digital Audio operation has priority if Digital Audio and AUDIO L/R are connected at the same time.

CableCARD™ Setup

How to use

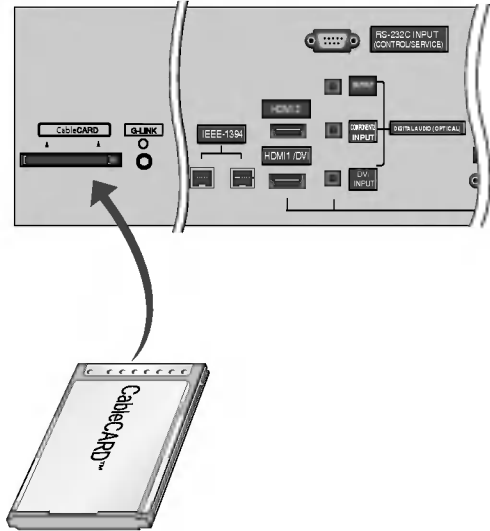
Insert the CableCARD™ received from the cable service provider to the CableCARD™ slot of TV back panel.
If the pairing information about this TV and the CableCARD is automatically displayed on the screen, contact with the cable service provider.

Note :

- CableCARD™ have the types of Motorola, Scientific Atlanta, SCM etc.. These 3 types of CableCARD™ can be used for this PLASMA TV.

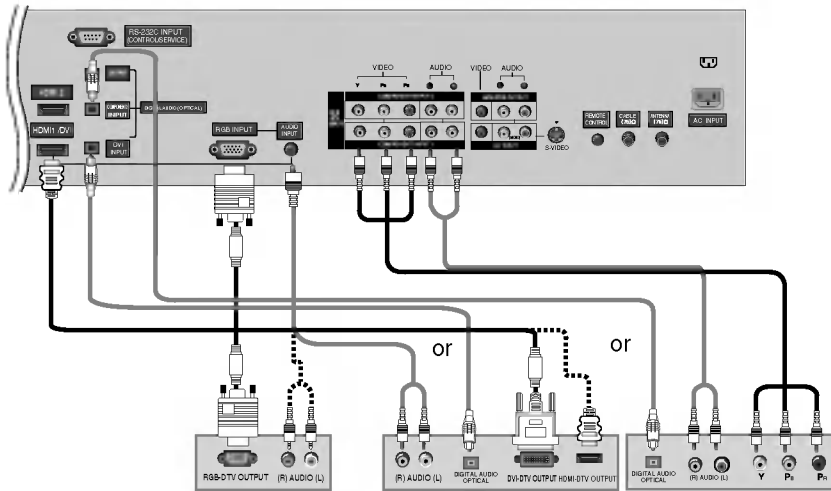


Caution: When removing the CableCARD™, do not drop it as this may cause damage to the CableCARD™.



HDSTB Setup

- This TV can receive Digital Over-the-air/Cable signals without an external digital set-top box. However, if you do receive Digital signals from a digital set-top box or other digital external device, refer to the figure as shown below.
- This TV supports HDCP (High-bandwidth Digital Contents Protection) protocol for Digital Contents (480p,720p,1080i).



Digital Set-top Box

How to connect

Use the TV's COMPONENT (Y, PB, PR) INPUT, RGB, HDMI1/DVI or HDMI2 jack for video connections, depending on your set-top box connector. Then, make the corresponding audio connections.

How to use

1. Turn on the digital set-top box. (Refer to the owner's manual for the digital set-top box.)
2. Use TV/VIDEO on the remote control to select **Component 1**, **Component 2**, **RGB-DTV**, **HDMI1/DVI** or **HDMI2** source.

Signal	Component 1/2	RGB-DTV,HDMI1/DVI,HDMI2
480i	Yes	No
480p	Yes	Yes
720p	Yes	Yes
1080i	Yes	Yes

PC Setup

- This TV provides Plug and Play capability, meaning that the PC adjusts automatically to the TV's settings.
- The TV perceives 640x480, 60Hz as DTV 480p based on the PC graphic card, change the screen scanning rate for the graphic card accordingly.

<When the PC supports DVI>

How to connect

1. Connect the PC to HDMI1/DVI port of this TV with an HDMI-to-DVI cable(not supplied with this product).
If you do not need to connect audio, HDMI2 port is also available for the DVI video connection.
2. If the PC(or the sound card of the PC) has a fiber optic digital audio output connector, connect the PC's audio output to DIGITAL AUDIO(OPTICAL) port for DVI INPUT.
3. If the PC(or the sound card of the PC) has an analog audio output connector, connect the PC's audio output to AUDIO INPUT port located on the right side of RGB INPUT port.

How To Use

1. To get the best picture quality, adjust the PC graphics card to 1024x768, 60Hz.
2. Select HDMI1/DVI input source in main input option of SETUP menu.(Refer to P.41)
TV/VIDEO button is also available for this purpose.
3. Check the image on your TV. There may be noise associated with the resolution, vertical pattern, contrast or brightness in PC mode. If noise is present, change the PC output to another resolution, change the refresh rate to another rate or adjust the brightness and contrast on the VIDEO menu until the picture is clear. If the refresh rate of the PC graphic card can not be changed, change the PC graphic card or consult the manufacturer of the PC graphic card.

<When the PC supports RGB>

How to connect

1. Connect the PC to RGB INPUT port of this TV with a RGB cable.
2. If the PC(or the sound card of the PC) has an analog audio output connector, connect the PC's audio output to AUDIO INPUT port located on the right side of RGB INPUT port.

How To Use

1. To get the best picture quality, adjust the PC graphics card to 1024x768, 60 Hz.
2. Select **RGB-PC** input source in main input option of SETUP menu.(Refer to P.41)
Once you select **RGB-PC** in main input option of SETUP menu, **TV/VIDEO** button is also available for this purpose.
3. Check the image on your TV. There may be noise associated with the resolution, vertical pattern, contrast or brightness in PC mode. If noise is present, change the PC output to another resolution, change the refresh rate to another rate or adjust the brightness and contrast on the VIDEO menu until the picture is clear. If the refresh rate of the PC graphic card can not be changed, change the PC graphic card or consult the manufacturer of the PC graphic card.

Monitor Display Specifications (RGB-PC)

Resolution	Horizontal Frequency(KHz)	Vertical Frequency(Hz)	Resolution	Horizontal Frequency(KHz)	Vertical Frequency(Hz)
720x400	31.469	70.08	800x600	35.156	56.25
	37.927	85.03		37.879	60.31
640x480	31.469	59.94		48.077	72.18
	37.861	72.80		46.875	75.00
	37.500	75.00		53.674	85.06
	43.269	85.00	1024x768	48.363	60.00
				56.476	70.06
				60.023	75.02

Monitor Display Specifications (RGB-DTV)

Resolution	Horizontal Frequency(KHz)	Vertical Frequency(Hz)
720x480	31.47	59.94
	31.50	60
1280x720	45.00	60.00
	44.96	59.94
1920x1080	33.75	60.00
	33.72	59.94

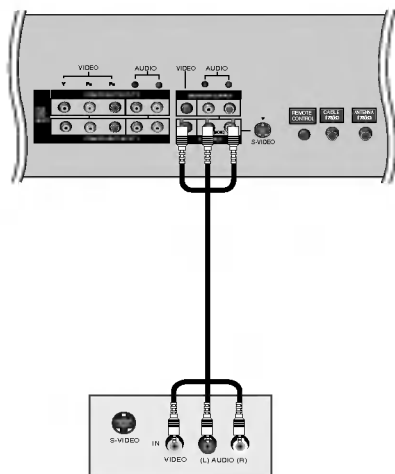
Monitor Display Specifications (HDMI-PC)

Resolution	Horizontal Frequency(KHz)	Vertical Frequency(Hz)	Resolution	Horizontal Frequency(KHz)	Vertical Frequency(Hz)
640x480	31.469	59.94	1024x768	48.363	60.00
	37.861	72.80		56.476	70.06
	37.500	75.00		60.023	75.02
	43.269	85.00			
800x600	35.156	56.25			
	37.879	60.31			
	48.077	72.18			
	46.875	75.00			
	53.674	85.06			

Monitor Display Specifications (HDMI-DTV)

Resolution	Horizontal Frequency(KHz)	Vertical Frequency(Hz)
720x480	31.500	60
	31.469	59.94
1280x720	45.00	60.00
	44.96	59.94
1920x1080	33.75	60.00
	33.72	59.94

Monitor Out Setup



The TV has a special signal output capability which allows you to hook up the second TV or monitor.

Connect the second TV or monitor to the TV's MONITOR OUT-PUT. See the Operating Manual of the second TV or monitor for further details regarding the device's input settings.

Note

- Component, RGB-PC/RGB-DTV, HDMI1/DVI, HDMI2, DTV input sources cannot be used for Monitor out.
- When connecting with external audio equipments, such as amplifiers or speakers, please turn the TV speakers off. (Refer to p.45)

Digital Audio Output

Send the TV's audio to external audio equipment via the Digital Audio Output (Optical) port.

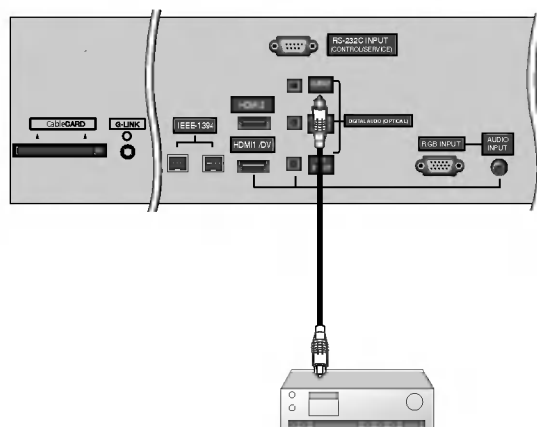
How to connect

1. Connect one end of an optical cable to the TV Digital Audio (Optical) Output port.
2. Connect the other end of the optical cable to the digital audio (optical) input on the audio equipment.
3. Set the "**TV Speaker** option - **Off**" in the AUDIO menu. Refer to page 45.
See the external audio equipment instruction manual for operation.

Note: When connecting with external audio equipments, such as amplifiers or speakers, please turn the TV speakers off. (Refer to p.45)



Caution: Do not look into the optical output port. Looking at the laser beam may damage your vision.



HDMI



- HDMI™, the HDMI logo and High-Definition Multimedia Interface is a trademark or registered trademark of HDMI Licensing."
- This TV can receive the High-Definition Multimedia Interface(HDMI) or the Digital Visual Interface(DVI).
- This TV supports HDCP(High-bandwidth Digital Contents Protection) Protocol for 720x480p, 1280x720p, and 1920x1080i resolution.
- When you connect this TV with a source device(DVD player, Set Top Box or PC) supporting Auto HDMI/DVI function, the output resolution of the source device will be automatically set to 1280x720p.
- If the source device does not support Auto HDMI1/DVI, you need to set the output resolution appropriately.
To get the best picture quality, adjust the DVD Player or Set Top Box's output resolution to 1280x720p, and the PC graphics card's output resolution to 1024x768, 60Hz.
- If the source device has an HDMI output, no other audio connection is necessary because HDMI-to-HDMI connection includes both video and audio.
- If the source device has a DVI output and no HDMI output, a separated audio connection is necessary.

<When the source device (DVD player or Set Top Box) supports HDMI>

How To Connect

1. Connect the source device to HDMI1/DVI or HDMI2 port of this TV with an HDMI cable(not supplied with this product).
2. No separated audio connection is necessary.

How To Use

- If the source device supports Auto HDMI function, the output resolution of the source device will be automatically set to 1280x720p.
- If the source device does not support Auto HDMI, you need to set the output resolution appropriately.
To get the best picture quality, adjust the output resolution of the source device to 1280x720p.
- Select HDMI1/DVI or HDMI2 input source in main input option of SETUP menu.(Refer to P.41)
TV/VIDEO button is also available for this purpose.

<When the source device(DVD player or Set Top Box) supports DVI>

How To Connect

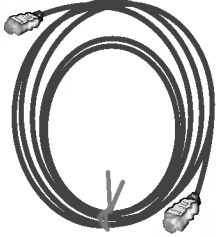
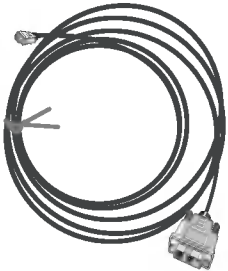
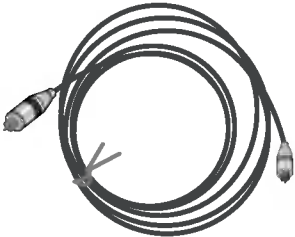


1. Connect the source device to HDMI1/DVI port of this TV with a HDMI-to-DVI cable(not supplied with this product).
Do not use HDMI2 port for DVI connection if you want to connect audio.
2. A separated audio connection is necessary.
3. If the source device has a fiber optic digital audio output, connect the audio output to DIGITAL AUDIO(OPTICAL) port for DVI INPUT.
4. If the source device has an analog audio output connector, connect the PC's audio output to AUDIO INPUT port located on the right side of RGB INPUT port.

How To Use

- If the source device supports Auto DVI function, the output resolution of the source device will be automatically set to 1280x720p.
- If the source device does not support Auto DVI, you need to set the output resolution appropriately.
To get the best picture quality, adjust the output resolution of the source device to 1280x720p.
- Select HDMI1/DVI input source in main input option on the SETUP menu. (Refer to P.41)
TV/VIDEO button is also available for this purpose.

Reference

Cable sample

	<p>HDMI Cable (not supplied with the product)</p>
	<p>HDMI to DVI Cable (not supplied with the product)</p>
	<p>Fiber Optic Digital Audio Cable (not supplied with the product)</p>
	<p>Analog Audio Cable(RCA type) (not supplied with the product)</p>
	<p>Analog Audio Cable(Stereo to RCA type) (not supplied with the product)</p>

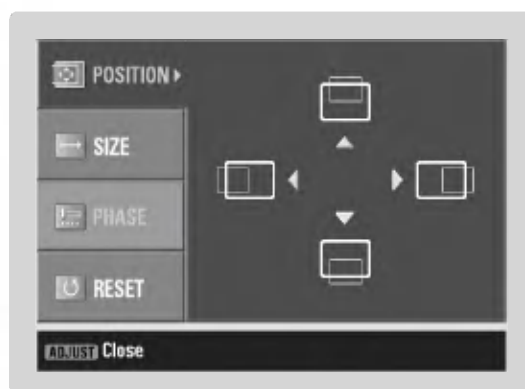
HDMI

How to use

1. Connect the HDMI1/DVI Source Devices(DVD Player or Set Top Box or PC) and the TV SET.
2. Turn on the display by pressing the POWER button on the TV SET and HDMI1/DVI Source Devices remote control.
3. Select HDMI1/DVI Input source in Main Input option on the SETUP menu.(Refer to P.41)
4. Check the image on your TV SET. There may be noise associated with the resolution, vertical pattern, contrast or brightness in HDMI1/DVI Source Devices. If noise is present, change the HDMI1/DVI Source Devices to another resolution, change the refresh rate or adjust the brightness and contrast on the menu until the picture is clear. If the refresh rate of the PC graphics card can not be changed, change the PC graphics card or consult the manufacturer of the PC graphics card.

Notes:

- Depending on the graphics card, DOS mode may not work if a HDMI1 to DVI Cable is in use.
- Avoid keeping a fixed image on the screen for a long period of time. The fixed image may become permanently imprinted on the screen. Use the Orbiter feature on the ISM Method menu.
- When Source Devices connected with HDMI1/DVI Input, output PC Resolution(VGA, SVGA, XGA), Position and Size may not fit to Screen. As shown in the picture below, press the **ADJUST** button to adjust the screen Position of TV SET and contact a PC graphics card service center.
- When Source Devices connected with HDMI1/DVI Input, output TV SET Resolution(480p, 720p, 1080i) and TV SET Display fit EIA/CEA-861-B Specification to Screen. If not, refer to the Manual of HDMI1/DVI Source Devices or contact your service center.
- In case HDMI1/DVI Source Devices is not connected Cable or poor cable connection, "NO SIGNAL" OSD display in HDMI1/DVI Input. In case that Video Resolution is not supported TV SET output in HDMI1/DVI Source Devices, "INVALID FORMAT" OSD display. Refer to the Manual of HDMI1/DVI Source Devices or contact your service center.



PC mode

In This Mode, the Supported TV SET Resolution Specification

- 1920 x 1080 I @ 59.94Hz / 60Hz, 16:9
- 1280 x 720 P @ 59.94Hz / 60Hz, 16:9(preferred format)
- 720 x 480 P @ 59.94Hz / 60Hz, 16:9
- 720 x 480 P @ 59.94Hz / 60Hz, 4:3

In This Mode, the Supported PC Resolution Specification

- 640 x 480 @ 59.94Hz
- 640 x 480 @ 72.80Hz
- 640 x 480 @ 75Hz
- 640 x 480 @ 85Hz
- 800 x 600 @ 56.25Hz
- 800 x 600 @ 60.31Hz
- 800 x 600 @ 72.18Hz
- 800 x 600 @ 75Hz
- 800 x 600 @ 85.06Hz
- 1024 x 768 @ 60Hz(preferred format)
- 1024 x 768 @ 70.06Hz
- 1024 x 768 @ 75.02Hz

TV Guide On Screen Setup

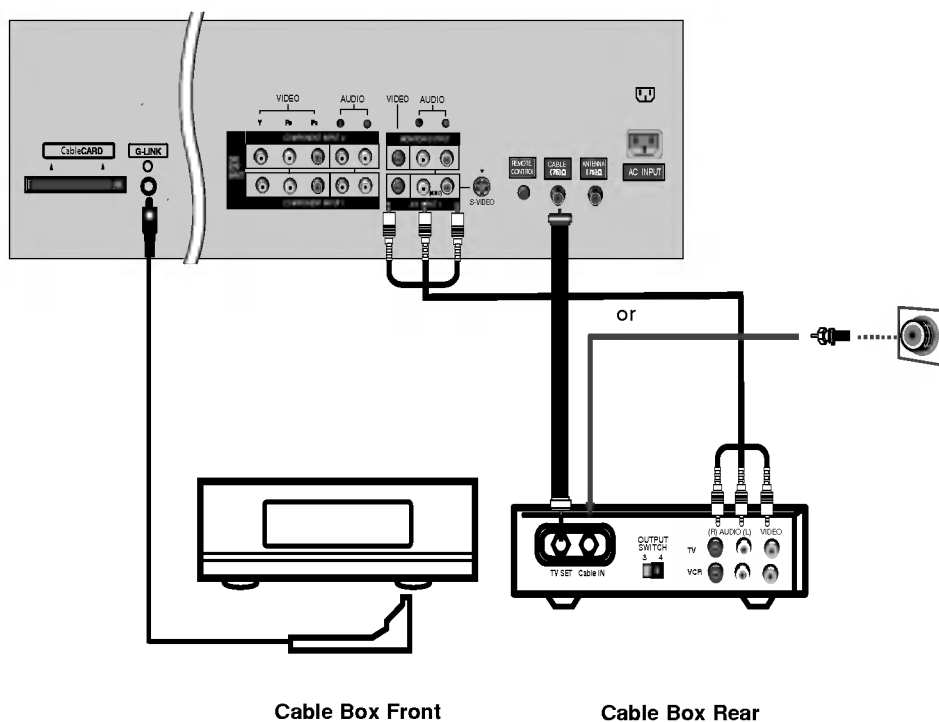
- The TV Guide On Screen system uses Setup information to provide you with show listings and lineups in your area—which are updated several times a day.
- Once you set up the TV according to manufacturer's instructions, you are ready to set up the TV Guide On Screen system.
- To download program listings the TV Guide On Screen system needs to be able to change channels on your cable box when the TV is not in use. Please connect the supplied G-LINK cable to the G-LINK jack of the TV. After you connect the G-LINK cable you will be able to control your cable box using the TV's remote.

Notes:

- The TV Guide On Screen system provides listings for cable-ready, cable box, and digital cable services as well as over-the-air broadcast. It does not provide listings for satellite services.
- You may use to connect directly without Cable Box.

How to connect Cable Box

Cable Service with a Cable Box



Note:

- The G-LINK™ cable is necessary for the TV Guide On Screen system to work with your Cable Box. See Page 29 for G-LINK™ connection instructions.

TV Guide On Screen Setup

1. Welcome Screen

The TV Guide On Screen system's Welcome Screen appears:

- by pressing the TV Guide key
- when you power On your TV if you previously skipped "Set up TV Guide On Screen now" on the Reminder Screen.

The Welcome Screen highlights features of the TV Guide On Screen system.

Press **ENTER** to begin Setup.



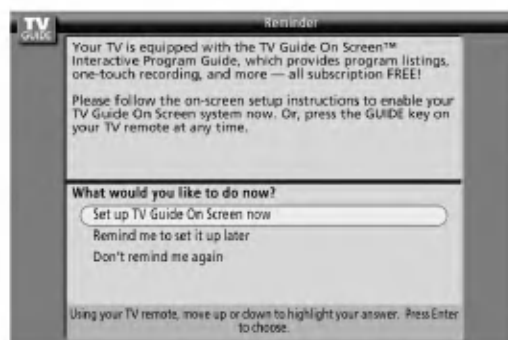
2. Reminder Screen

The TV Guide On Screen system's Reminder Screen appears:

- after initial TV set up
- if you power Off the TV and then power it back On

To make a selection, use the ▲ / ▼ button to highlight an option, and press **ENTER**.

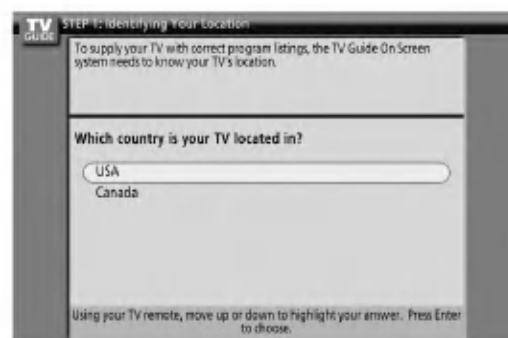
- "Set up TV Guide On Screen now," displays the Welcome Screen. Press **ENTER** to begin Setup.
- "Remind me to set up later" returns you to watching TV.
- "Don't remind me again" returns you to watching TV and stops the reminder screen from appearing upon power On.



How to use

1. Screen 1: Country

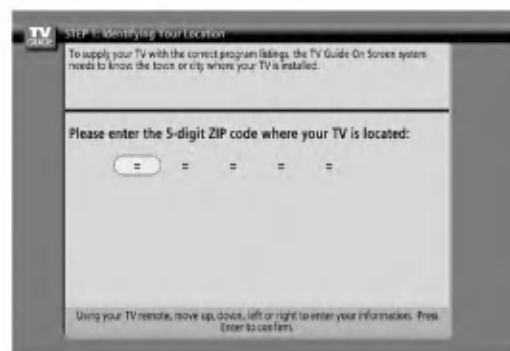
- This screen asks you the location of your TV.
- Use the ▲ / ▼ button to highlight a country.
- Press **ENTER** to display Screen 2.



2. Screen 2: Enter ZIP or Postal Code

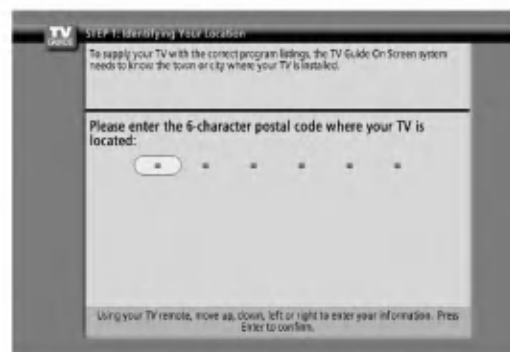
Option 1

- If you selected USA in Screen 1, you see the ZIP Code screen.
- You input numbers by either pressing the number keys on the remote or using the ▲ / ▼ button to display a number, and then the ◀ / ▶ button to move to another field.
- Press **ENTER** to display Screen 3.



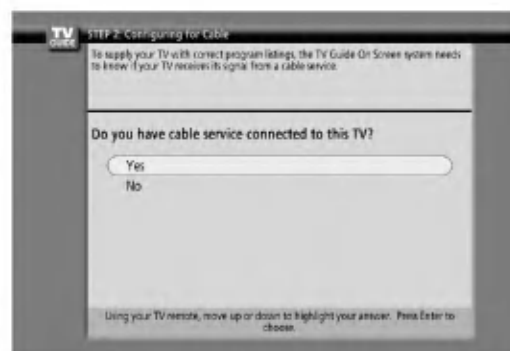
Option 2

- If you selected Canada in Screen 1, you see the Postal Code screen.
- You input characters by using the ▲ / ▼ button, and then the ◀ / ▶ button to move to another field.
- Press **ENTER** to display Screen 3.



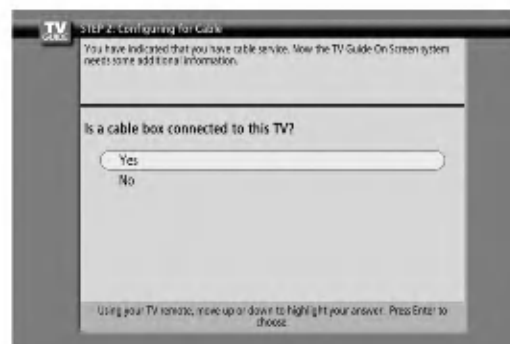
3. Screen 3: Do you have Cable Service connected?

- If you select Yes, you see Screen 4.
- If you select No, you see Screen 12.



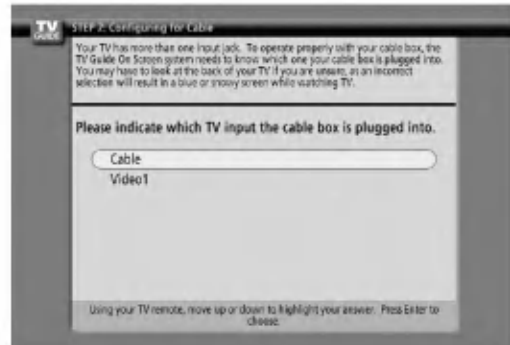
4. Screen 4: Do you have a Cable Box?

- If you select Yes, you see Screen 5.
- If you select No, you see Screen 12.



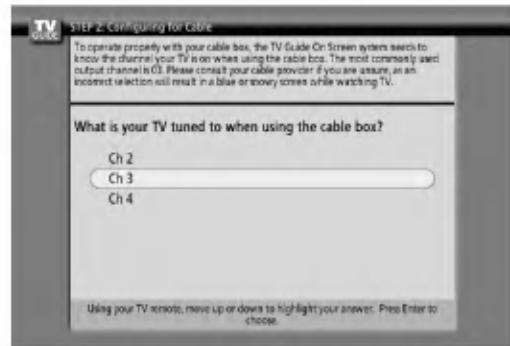
5. Screen 5: Which TV input is the cable box plugged into?

- If you select Cable, you see Screen 6.
- If you make any other choice, you see Screen 7 .



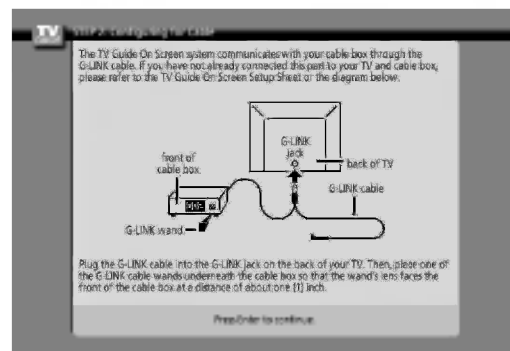
6. Screen 6: Cable Box Tuning Channel

- Select the channel used for the cable box.
- Press **ENTER** to display Screen 7.



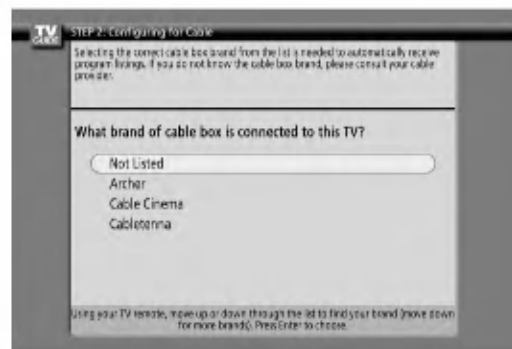
7. Screen 7: Cable Box Configuration Diagram

- The diagram shows the correct way to install the G-LINK Cable from the back of the device to the cable box.
Make sure the G-LINK™ Cable is properly installed.
- Press **ENTER** to display Screen 8.



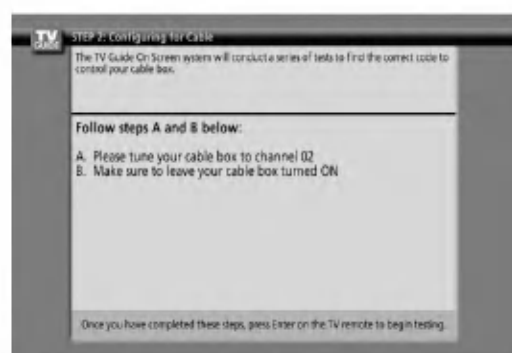
8. Screen 8: Cable Box Brand Name

- Use the ▲ / ▼ button to select a cable box brand.
- Press **ENTER** to display Screen 9.



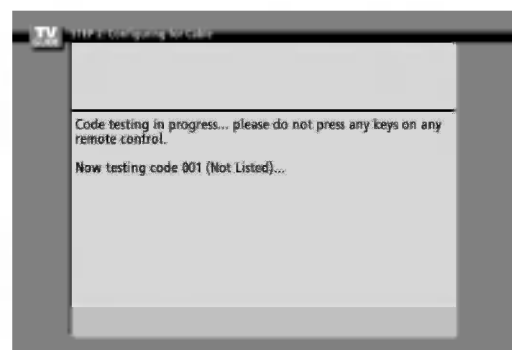
9. Screen 9: Cable Box Preparation

- Follow the on-screen instructions, and press **ENTER** to display Screen 10.



10. Screen 10: Cable Box Code Testing

- When testing is done, Screen 11 displays automatically.

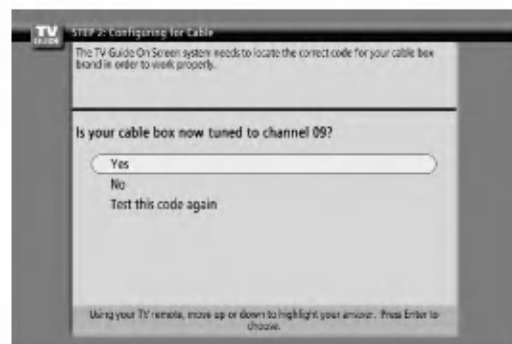


11. Screen 11: Cable Box Tuned to Channel 9?

- If you select Yes, you see Screen 12.
- If you select No, a different code is tested in Screen 10.

Note:

- *Many Cable Boxes require testing more than one code.*
- If you select Test this code again, the same code is tested again in Screen 10.



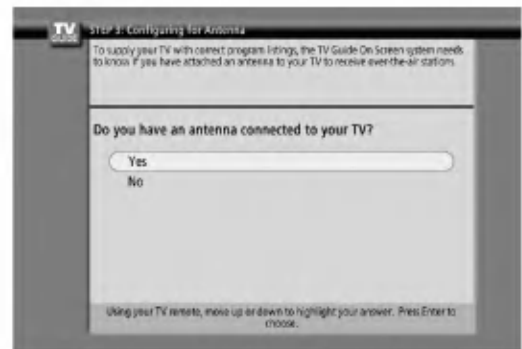
12. Screen 12: Do you have an antenna connected?

- If you select Yes, you see Screen 13.

Note:

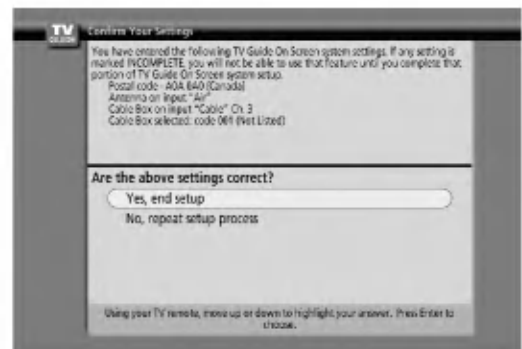
•If you selected No in Screen 3 then you must select Yes in this screen to receive a channel lineup and listings.

- If you select No, you see Screen 13.



13. Screen 13: Are your basic settings correct?

- If you select Yes, you see Screen 14.
- If you select No, you see Screen 1.



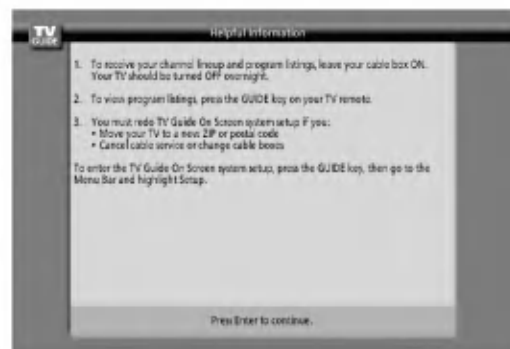
14. Screen 14: Congratulations

- Press ENTER to display Screen 15.



15. Screen 15: Helpful Information

- This screen tells you valuable information on using your Guide.
- Press **ENTER** to watch TV.



Notes:

- The TV Guide On Screen system receives program listings data through your cable or over-the-air video signal. In order to receive regular program listings, please remember to do the following:
 1. Turn OFF your TV when it is not in use. (Do not unplug the power cord.)
 2. If you have a Cable box connected, leave the cable box On, but turn the TV Off.
 3. If you have more than one Cable system in your area, you may be prompted to select which Cable system's program data to download. If so prompted, please follow the on-screen instructions.
- Program listings are updated several times a day. It may take up to 24 hours to begin to receive any TV program listings. It may take up to one week to receive all eight days of TV program listings.

Operation

Turning the TV On

1. First, connect power cord correctly. At this moment, the TV switches to standby mode.

In standby mode to turn TV on, press the $\phi/1$, **TV/VIDEO** \odot , **CH** (\blacktriangle / \blacktriangledown) button on the TV or press the **POWER**, **TV/VIDEO**, **TV INPUT**, **CH** ($\blacktriangle/\blacktriangledown$), **Number** (0 ~ 9) button on the remote control.

2. Select the viewing source by using **TV/VIDEO**, **TV INPUT** button on the remote control.

This TV is programmed to remember which mode it was last set to, even if you turn the TV off.

3. When finished using the TV, press the **POWER** button on the remote control. The TV reverts to standby mode.

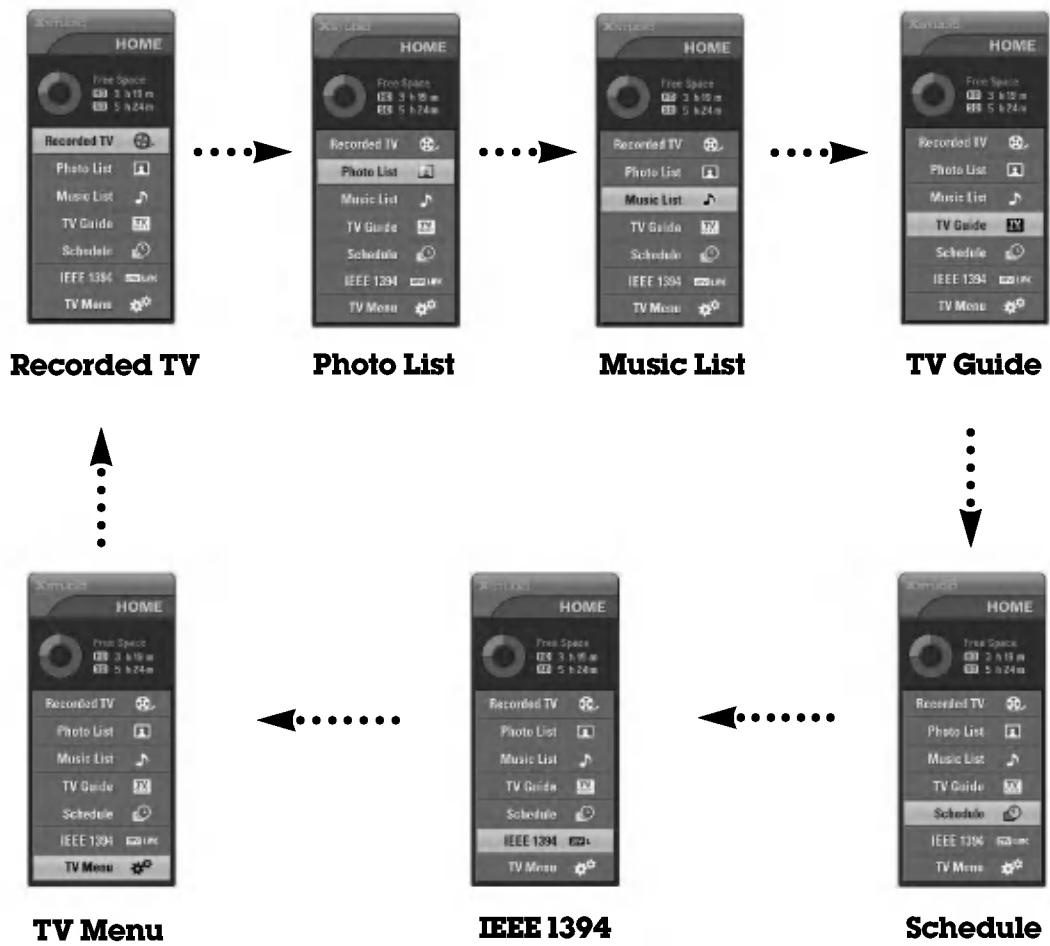
Notes:

- If you intend to be away on vacation, disconnect the power plug from the wall power outlet.
- After turning on the TV, it will take up to a week for the TV Guide On Screen system to receive full listings data.
- Illuminates orange in standby mode. When the TV is turned on, the indicator will blink green for 3-4 seconds before the picture is seen.
- When the TV is turned On, the TV Guide On Screen system is automatically displayed. The screen may be slightly delayed if the TV was unplugged and then powered On.

HOME Menu

- This menu is a contents guide.

In **HOME** Menu, you enter the recorded list of DVR, photo list and music list of DVR or Memory Card, TV Guide, Schedule of the TV Guide, IEEE1394 or TV Menu.



TV Setup

On-screen Menu Language Selection

- The menu can be shown on the screen in the selected language. First select your language.

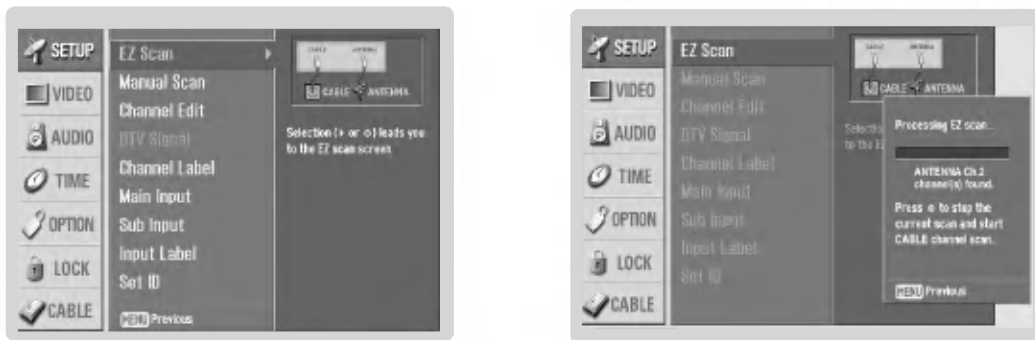
1. Press the **MENU** button and then use ▲ / ▼ button to select the **OPTION** menu.
2. Press the ► button and then use ▲ / ▼ button to select **Language**.
3. Press the ► button and then use ▲ / ▼ button to select your desired language. From this point on, the on-screen menu will be shown in the selected language.
4. Press **EXIT** button to return to TV viewing or press **MENU** button to return to the previous menu.



Setup Menu Options

EZ Scan (Channel Search)

- Automatically finds all channels available through antenna or cable inputs, and stores them in memory on the channel list.
- Run EZ Scan again after any Antenna/Cable connection changes.
- A password is required to gain access to EZ Scan menu if the Lock System is turned on.

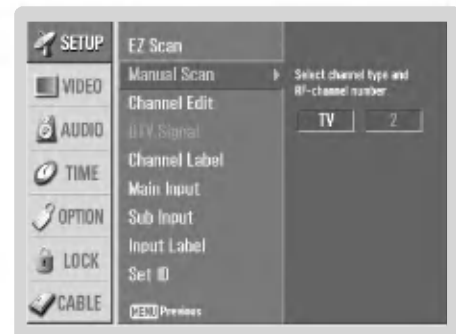


1. Press the **MENU** button and then use ▲ / ▼ button to select the **SETUP** menu.
2. Press the ► button and then use ▲ / ▼ button to select **EZ Scan**.
3. Press the **ENTER** button to begin the channel search.
Allow EZ Scan to complete the channel search cycle for ANTENNA, and CABLE.

Manual Scan

- A password is required to gain access to Manual Scan menu if the Lock System is turned on.

1. Press the **MENU** button and then use ▲ / ▼ button to select the **SETUP** menu.
2. Press the ► button and then use ▲ / ▼ button to select **Manual Scan**.
3. Press the ► button and then use ▲ / ▼ button to select TV, DTV, CATV, and CADTV.
4. Press the ► button and then use ▲ / ▼ button to select channel number you want to add or delete.
5. Press the **ENTER** button to add or delete for the channel number.
6. Press **EXIT** button to return to TV viewing or press **MENU** button to return to the previous menu.



Notes:

- This channel number is a physical channel number, which is different from the normal channel number shown in Channel Edit.
- When a cable box connects to the physical channel 2,3 or 4 in the TV Guide On Screen system Setup, cable channels(CATV or CADTV) will not be scanned by EZ Scan or Manual Scan.
- When inserting the CableCARD™, CATV, CADTV is not working in Manual Scan.
- TV: analog antenna(over-the-air) TV signal
DTV: digital antenna(over-the-air) TV signal
CATV: analog cable TV signal
CADTV: digital cable TV signal

Setup Menu Options

Channel Edit

- Create two different types of channel lists in memory: "Custom list" and "Favorite channel list" from the default channel list created from the EZ Scan channel search.
- A custom list can be created by toggling each channel on or off with **ENTER** button. The channels in the Custom List are displayed in black color, and the channels deleted from the Custom List are displayed in gray color. Once a channel is highlighted you can add or delete the channel by referring to the small window at the top-left corner of the screen. You can create your own Favorite List. Use the **FAV** button on the remote control when a channel is highlighted and then you can add or delete the channel to/from the Favorite List.



1. Press the **MENU** button and then use **▲ / ▼** button to select the **SETUP** menu.
2. Press the **▶** button and then use **▲ / ▼** button to select **Channel Edit**.
3. Press the **▶** button. You will now see a screen filled with channel numbers and a preview picture.
4. Use **▲ / ▼ / ◀ / ▶** button to select a channel and then use the **ENTER** button to add or delete it. Press **FAV** button to add the channel to the Favorite List.
5. Press **EXIT** button to return to TV viewing or press **MENU** button to return to the previous menu.



Note:

- When a cable box connects to the physical channel 2, 3, or 4 in TV Guide On Screen Setup, cable channels (CATV or CADTV) will not be editable by Channel Edit. Instead, use the cable box's Channel Edit if available.

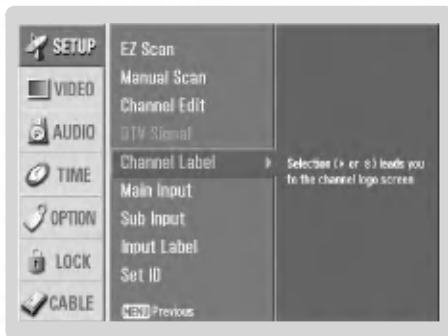
DTV Signal Strength

- Shows DTV signal levels which are received to your TV whether you need to adjust your antenna or digital cable input. The higher the signal strength, the less likely you are to experience picture degradation.
- DTV Signal: Only when the input signal is DTV or CADTV, this function is available.

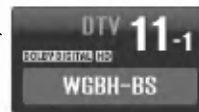
1. Press the **MENU** button and then use **▲ / ▼** button to select the **SETUP** menu.
2. Press the **▶** button and then use **▲ / ▼** button to select **DTV Signal**.
3. View the on-screen signal strength monitor to see the quality of the signal being received.
4. Press **EXIT** button to return to TV viewing or press **MENU** button to return to the previous menu.

Channel Label Setup

- Choose preset labels for your channels.
- If a channel label is provided on the signal from the broadcasting station, the TV displays a short name for a channel - even if you didn't preset a label for the channel.



1. Press the **MENU** button and then use **▲ / ▼** button to select the **SETUP** menu.
 2. Press the **▶** button and then use **▲ / ▼** button to select **Channel Label**.
 3. Press the **▶** button. You will now see a screen filled with Labels and a preview screen.
 4. Use the **CH (▲▼)** button to select a channel to Label.
 5. Use **▲ / ▼ / ◀ / ▶** button to select the appropriate label for the channel, then press **ENTER** button to set the Label to the selected channel.
- If you press **ENTER** button, you will see the channel banner. ...▶



Main Picture Source Selection

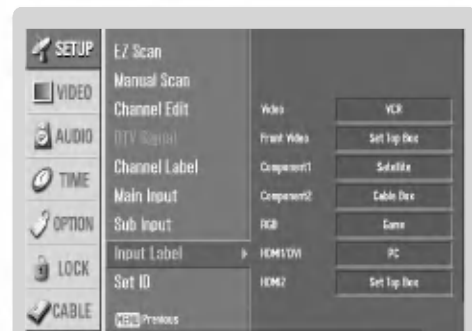
- Changes the picture source so you can watch your off-air TV, cable TV, VCR, DVD, or any other devices that are connected to your TV.

1. Press the **MENU** button and then use **▲ / ▼** button to select the **SETUP** menu.
2. Press the **▶** button and then use **▲ / ▼** button to select **Main Input**.
3. Press the **▶** button and then use **▲ / ▼** button to select the source: Antenna, Cable, Video, Front Video, Component1, Component2, RGB-DTV (or RGB-PC), HDMI1/DVI, HDMI2.
4. Press **EXIT** button to return to TV viewing or press **MENU** button to return to the previous menu.



Input Label

1. Press the **MENU** button and then use **▲ / ▼** button to select the **SETUP** menu.
2. Press the **▶** button and then use **▲ / ▼** button to select **Input Label**.
3. Press the **▶** button and then use **▲ / ▼** button to select the source: Video, Front Video, Component1, Component2, RGB, HDMI1/DVI or HDMI2.
4. Press **EXIT** button to return to TV viewing or press **MENU** button to return to the previous menu.



Video Menu Options

EZ Picture

- EZ Picture adjusts the TV for the best picture appearance. Select the preset value in the EZ Picture menu based on the program category.
- When adjusting Video menu options (contrast, brightness, color, sharpness, tint, and color temperature) manually, EZ Picture automatically changes to **Custom**.
- **Daylight, Normal, Night Time, Movie, Video Game, and Sports** settings are preset for optimum picture quality at the factory and are not adjustable.

1. Press the **EZ PIC** button repeatedly to select the picture appearance setup option as shown below:
Custom (your own settings), **Daylight, Normal, Night Time, Movie, Video Game, and Sports**.
 - You can also use the **VIDEO** menu to adjust **EZ Picture**.
2. Press the **EXIT** button to save and return to TV viewing.

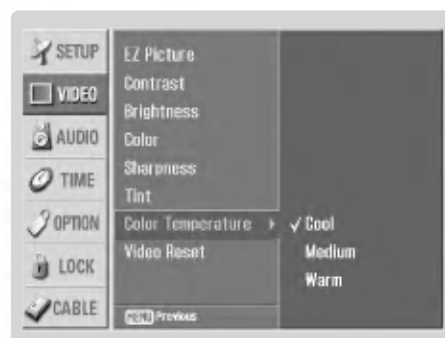
Manual Picture Control (**Custom** option)

- Adjust the picture appearance to suit your preference and viewing situations.
1. Press the **MENU** button and then use **▲ / ▼** button to select the **VIDEO** menu.
 2. Press the **▶** button and then use **▲ / ▼** button to select the desired picture option (**Contrast, Brightness, Color, Sharpness, or Tint**).
 3. Press the **▶** button and then use **◀ / ▶** button to make appropriate adjustments.
 4. Press **EXIT** button to return to TV viewing or press **MENU** button to return to the previous menu.



Color Temperature Control

- Choose one of three automatic color adjustments. Set to warm to enhance hotter colors such as red, or set to cool to see less intense colors with more blue.
1. Press the **MENU** button and then use **▲ / ▼** button to select the **VIDEO** menu.
 2. Press the **▶** button and then use **▲ / ▼** button to select **Color Temperature**.
 3. Press the **▶** button and then use **▲ / ▼** button to select either **Cool, Medium** or **Warm**.
 4. Press **EXIT** button to return to TV viewing or press **MENU** button to return to the previous menu.



Video Reset

- Use to quickly reset all the Video menu options to their original factory preset values.
1. Press the **MENU** button and then use **▲ / ▼** button to select the **VIDEO** menu.
 2. Press the **▶** button and then use **▲ / ▼** button to select **Video Reset**.
 3. Press the **▶** button to reset the Video menu options to original values.
 4. Press **EXIT** button to return to TV viewing or press **MENU** button to return to the previous menu.



Audio Menu Options

Audio Language

- Other languages may be available if a digital signal is provided by the broadcasting station.
1. Press the **MENU** button and then use ▲ / ▼ button to select the **AUDIO** menu.
 2. Press the ► button and then use ▲ / ▼ button to select **Audio Language**.
 3. Press the ► button and then use ▲ / ▼ button to select: English, Spanish, or French.
 4. Press **EXIT** button to return to TV viewing or press **MENU** button to return to the previous menu.



EZ SoundRite

- Scans for changes in sound level during commercials, then adjusts the sound to match the specified audio level. SoundRite makes sure that the volume level remains consistent whether you are watching a commercial or a regular TV program.
1. Press the **MENU** button and then use ▲ / ▼ button to select the **AUDIO** menu.
 2. Press the ► button and then use ▲ / ▼ button to select **EZ SoundRite**.
 3. Press the ► button and then use ▲ / ▼ button to select **On** or **Off**.
 4. Press **EXIT** button to return to TV viewing or press **MENU** button to return to the previous menu.



EZ Sound

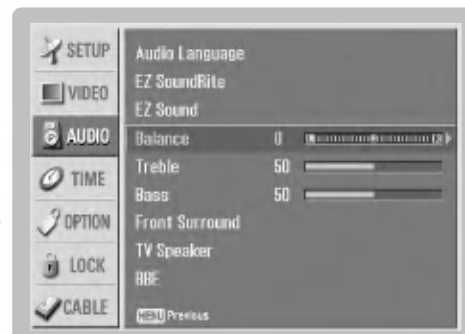
- EZ Sound lets you enjoy the best sound without any special adjustment because the TV sets the appropriate sound options based on the program content.
 - When adjusting sound options (treble, bass, and front surround) manually, EZ Sound automatically switches **Custom**.
 - **Normal, Stadium, News, Music, and Theater** are preset for good sound quality at the factory and are not adjustable.
1. Press the **EZ SOUND** button repeatedly to select the appropriate sound setup as shown below:
 - Custom** (your own settings), **Normal, Stadium, News, Music, and Theater**.
 - You can also adjust **EZ Sound** in the **AUDIO** menu.
 2. Press **EXIT** button to save and return to TV viewing.

Audio Menu Options


Manual Sound Control (**Custom** option)

- Adjust the sound to suit your taste and room situations.

1. Press the **MENU** button and then use ▲ / ▼ button to select the **AUDIO** menu.
2. Press the ► button and then use ▲ / ▼ button to select the desired sound option (**Balance**, **Treble**, or **Bass**).
3. Press the ► button and then use ◀ / ▶ button to make appropriate adjustments.
4. Press **EXIT** button to return to TV viewing or press **MENU** button to return to the previous menu.



Front Surround

-  is a trademark of SRS Labs, Inc.
- TruSurround XT technology is incorporated under license from SRS Labs, Inc.
- Manufactured under license from Dolby Laboratories. "Dolby" and the double-D symbol are trademarks of Dolby Laboratories.

1. Press the **MENU** button and then use ▲ / ▼ button to select the **AUDIO** menu.
2. Press the ► button and then use ▲ / ▼ button to select **Front Surround**.
3. Press the ► button and then use ▲ / ▼ button to select **Off**, **3D EchoSound System** or **SRS** (Sound Retrieval System) **TruSurround XT**.

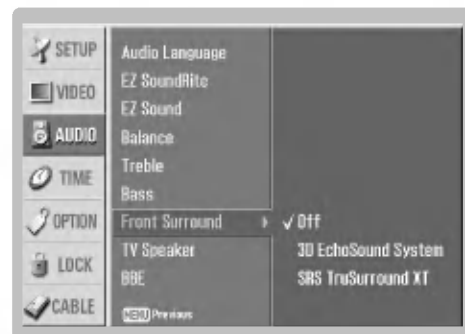
• 3D EchoSound System

Creates a stunning simulated stereo effects from any mono sound and a realistic three-dimensional sound with a very wide and deep sound stage into stereo sound.

• SRS TruSurround XT

Takes advantage of any multi-channel format without needing to add extra speakers or equipment. Dialog clarity, bass enrichment, and the addition of stereo audio enhancement that produces an immersive sound experience from standard stereo material.

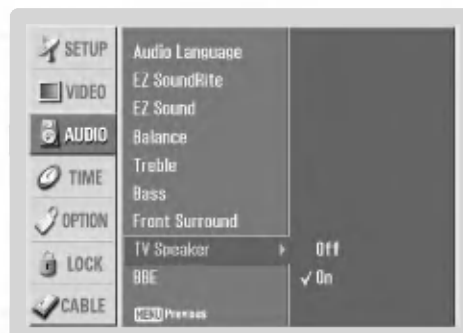
4. Press **EXIT** button to return to TV viewing or press **MENU** button to return to the previous menu.



TV Speakers On/Off Setup

- Turn TV speakers off if using external audio equipment. Feature turns the TV Speakers option On or Off.

1. Press the **MENU** button and then use ▲ / ▼ button to select the **AUDIO** menu.
2. Press the ► button and then use ▲ / ▼ button to select **TV Speaker**.
3. Press the ► button and then use ▲ / ▼ button to select **On** or **Off**.
4. Press **EXIT** button to return to TV viewing or press **MENU** button to return to the previous menu.



Stereo/SAP Broadcasts Setup

- This TV can receive MTS stereo programs and any SAP (Secondary Audio Program) that accompanies the stereo program; if the station transmits an additional sound signal as well as the original one.
- When having selected Stereo or SAP button on the remote control, this TV can only receive the signal when the TV station transmits the proper signals.
- Mono sound is automatically received if the broadcast is only in Mono; even though Stereo or SAP has been selected.
- Select Mono if you want to listen to the mono sound in remote areas during stereo/SAP broadcasting.
- Stereo or SAP can be received in Analog channel.

1. Use the **SAP** button to select your desired MTS mode in analog signal. Each time you press the **SAP** button, **Mono**, **Stereo**, or **SAP** appear in turn.
 - If other languages available on the digital signal, select them with the **SAP** button.
2. Press **EXIT** button to save and return to TV viewing.

BBE

- BBE High Definition Sound restores clarity and presence for better speech intelligibility and musical realism.

1. Press the **MENU** button and then use ▲ / ▼ button to select the **AUDIO** menu.
2. Press the ► button and then use ▲ / ▼ button to select **BBE**.
3. Press the ► button and then use ▲ / ▼ button to select **On** or **Off**.
4. Press **EXIT** button to return to TV viewing or press **ENTER** button to return to the previous menu.

BBE. Manufactured under license from BBE Sound, Inc.



Time Menu Options

Auto Clock Setup

- The time is set automatically from a digital channel signal.
- The digital channel signal includes information for the current time provided by the broadcasting station.
- Set the clock manually, if the current time is set incorrectly by the auto clock function.
- When you set up the TV Guide On Screen system, **Auto Clock** menu is not selected.

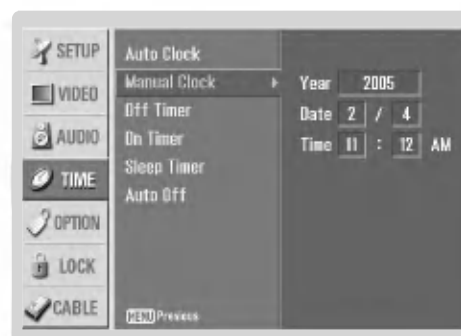
1. Press the **MENU** button and then use **▲ / ▼** button to select the **TIME** menu.
2. Press the **▶** button and then use **▲ / ▼** button to select **Auto Clock**.
3. Press the **▶** button and then use **▲ / ▼** button to select **On**.
4. Press the **▶** button and then use **▲ / ▼** button to select your viewing area time zone: **Eastern, Central, Mountain, Pacific, Alaska, or Hawaii**.
5. Press **EXIT** button to return to TV viewing or press **MENU** button to return to the previous menu.



Manual Clock Setup

- If current time setting is wrong, reset the clock manually.
- When you set up the TV Guide On Screen system, **Manual Clock** menu is not selected.

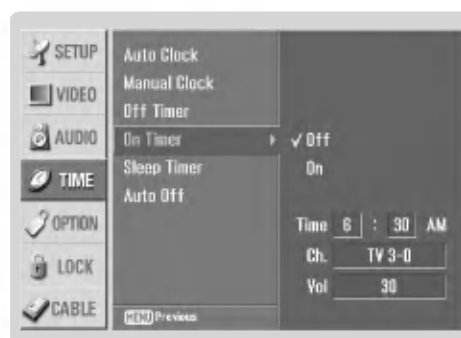
1. Press the **MENU** button and then use **▲ / ▼** button to select the **TIME** menu.
2. Press the **▶** button and then use **▲ / ▼** button to select **Manual Clock**.
3. Press the **▶** button and then use **◀ / ▶** button to select either the year, date, or time option. Once selected, use the **▲ / ▼** button to set the year, date, and time options.
4. Press **EXIT** button to return to TV viewing or press **MENU** button to return to the previous menu.



On/Off Timer Setup

- Timer function operates only if current time has been set.
- Off-Timer function overrides On-Timer function if they are set both to the same time.
- The TV must be in standby mode for the On-Timer to work.
- If you do not press any button within 2 hours after the TV turns on with the On Timer function, the TV will automatically revert to standby mode.

1. Press the **MENU** button and then use **▲ / ▼** button to select the **TIME** menu.
2. Press the **▶** button and then use **▲ / ▼** button to select **Off Timer** or **On Timer**.
3. Press the **▶** button and then use **▲ / ▼** button to select **On**.
 - To cancel **On/Off timer** function, select **Off**.
4. Press the **▶** button and then use **▲ / ▼** button to set the hour.
5. Press the **▶** button and then use **▲ / ▼** button to set the minutes.
6. **For only On timer function**
 - Press the **▶** button and then use **▲ / ▼** button to select the channel at turn-on.
 - Press the **▶** button and then use **▲ / ▼** button to set the sound level at turn-on.
7. Press **EXIT** button to return to TV viewing or press **MENU** button to return to the previous menu.

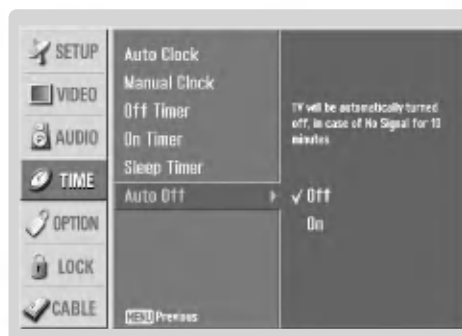


Sleep Timer

- The Sleep Timer turns the TV off at the preset time. Note that this setting is cleared when the TV is turned off.
 - You can also set up the **Sleep Timer** in the **TIME** menu.
1. Press the **TIMER** button repeatedly to select the number of minutes. First the **Off** option appears on the screen, followed by the following sleep timer options: 10, 20, 30, 60, 90, 120, 180, and 240 minutes.
 2. When the number of minutes you want is displayed on the screen, press the **ENTER** button. The timer begins to count down from the number of minutes selected.
 3. To check the remaining minutes before the TV turns off, press the **TIMER** button once.
 4. To cancel the Sleep Timer, press the **TIMER** button repeatedly to select **Off**.

Auto Off

- If set to on and there is no input signal, the TV turns off automatically after 10 minutes.
1. Press the **MENU** button and then use **▲ / ▼** button to select the **TIME** menu.
 2. Press the **▶** button and then use **▲ / ▼** button to select **Auto Off**.
 3. Press the **▶** button and then use **▲ / ▼** button to select **On** or **Off**.
 4. Press **EXIT** button to return to TV viewing or press **MENU** button to return to the previous menu.



Option Menu Features

Advanced

TimeShift Mode

- See Page 73-74 for TimeShift functions.

Cinema 3:2 Mode Setup

- Set up the TV for the best picture appearance for viewing movies.

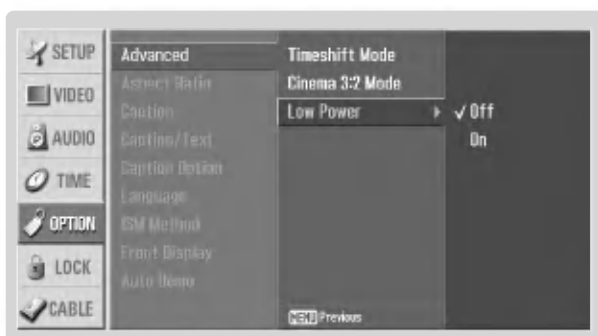


1. Press the **MENU** button and then use **▲ / ▼** button to select the **OPTION** menu.
2. Press the **▶** button and then use **▲ / ▼** button to select **Advanced**.
3. Press the **▶** button and then use **▲ / ▼** button to select **Cinema 3:2 Mode**.
4. Press the **▶** button and then use **▲ / ▼** button to select **On** or **Off**.
5. Press **EXIT** button to return to TV viewing or press **MENU** button to return to the previous menu.

Note: This feature operates only in 480i mode.

Low Power

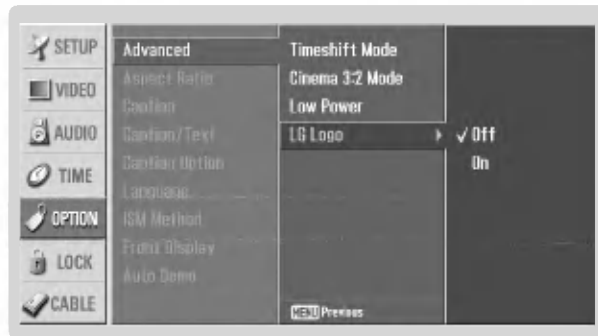
- Low power reduces the plasma display power consumption.



1. Press the **MENU** button and then use **▲ / ▼** button to select the **OPTION** menu.
2. Press the **▶** button and then use **▲ / ▼** button to select **Advanced**.
3. Press the **▶** button and then use **▲ / ▼** button to select **Low power**.
4. Press the **▶** button and then use **▲ / ▼** button to select **On** or **Off**.
 - When you select **On**, the screen darkens.
5. Press **EXIT** button to return to TV viewing or press **MENU** button to return to the previous menu.

LG Logo

- This function is only applied to 60PY2DR/60PY2DRH model.



1. Press the **MENU** button and then use **▲ / ▼** button to select the **OPTION** menu.
2. Press the **▶** button and then use **▲ / ▼** button to select **Advanced**.
3. Press the **▶** button and then use **▲ / ▼** button to select **LG Logo**.
4. Press the **▶** button and then use **▲ / ▼** button to select **On** or **Off**.
 - When you select **On**, the light for the Logo is on.
5. Press **EXIT** button to return to TV viewing or press **MENU** button to return to the previous menu.

Option Menu Features

Aspect Ratio Control

- Lets you choose the way an analog picture with a 4:3 aspect ratio is displayed on your TV with a 16:9 ratio picture format. When you receive an analog picture with a 4:3 aspect ratio on your 16:9 TV, you need to specify how the picture is to be displayed.
 - If you are viewing a picture with a 16:9 aspect ratio, you can't use the Horizon aspect ratio option.
 - Horizon aspect ratio is not available for Component 1-2 (480p/720p/1080i)/RGB-DTV (480p/720p/1080i)/HDMI1/DVI-DTV (720p/1080i)/DTV(720p/1080i), HDMI2-DTV(720p/1080i) input source.
 - RGB-PC/DVI-PC input source use 4:3 or 16:9 aspect ratio.
 - **Note:** If a fixed image is displayed on the screen for a long time, it image may become imprinted on the screen and remain visible.
1. Press the **RATIO** button repeatedly to select the desired picture format.
You can also adjust **Aspect Ratio** in the **OPTION** menu.

- **Set By Program**

Selects the proper picture proportion to match the source's image. (4:3 → 4:3, 16:9 → 16:9)

- **4:3**

Choose **4:3** when you want to view a picture with an original 4:3 aspect ratio, with gray bars appearing at both the left and right sides.

- **16:9**

Choose **16:9** when you want to adjust the picture horizontally, in a linear proportion to fill the entire screen.

- **Horizon**

Choose **Horizon** when you want to adjust the picture in a non-linear proportion, that is, more enlarged at both sides, to create a spectacular view.

- **Zoom 1**

Choose **Zoom 1** when you want to view the picture without any alteration. However, the top and bottom portions of the picture will be cropped.

- **Zoom 2**

Choose **Zoom 2** when you want the picture to be altered, both vertically extended and cropped. The picture taking a halfway trade off between alteration and screen coverage.

- **Cinema Zoom**

Choose **Cinema Zoom** when you want to enlarge the picture in correct proportion. Note: When enlarging or reducing the picture, the image may become distorted.

You can adjust the enlarge proportion of Cinema Zoom using ▲ / ▼ button. The adjustment range is 1~16.

Caption

1. Press the **MENU** button and then use ▲ / ▼ button to select the **OPTION** menu.
2. Press the ► button and then use ▲ / ▼ button to select **Caption**.
3. Press the ► button and then use ▲ / ▼ button to select **On** or **Off**.
4. Press **EXIT** button to return to TV viewing or press **MENU** button to return to the previous menu.



Caption/Text

Analog Broadcasting System Captions

- Select a caption mode for displaying captioning information if provided on a program.
- Analog caption displays information at any position on the screen usually the program's dialog.
- Text displays information, usually at the bottom position and is used for a data service, generally not program related.
- Caption/Text, if provided by the broadcaster, would be available for both digital and analog channels on the Antenna/Cable.
- This TV is programmed to memorize the caption/text mode which was last set to, when you turn the power off.

1. Use the **CC** button repeatedly to select Caption **CC1, CC2, CC3, CC4, Text1, Text2, Text3, or Text4**.
 - **EZ Mute** shows the selected captions option (if available on program) when the TV sound is muted
2. Press **EXIT** button to save and return to TV viewing.

• You can also use the **OPTION** menu to select **Caption/Text**.

1. Press the **MENU** button and then use ▲ / ▼ button to select the **OPTION** menu.
2. Press the ► button and then use ▲ / ▼ button to select **Caption/Text**.
3. Press the ► button and then use ▲ / ▼ button to select caption: **CC1, CC2, CC3, CC4, Text1, Text2, Text3, or Text4**.

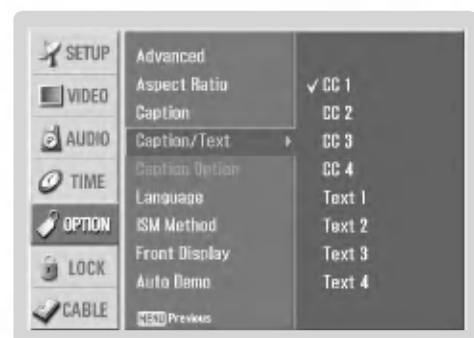
• CAPTION

The term for the words that scroll across the bottom of the TV screen; usually the audio portion of the program provided for the hearing impaired.

• TEXT

The term for the words that appear in a large black frame and almost cover the entire screen; usually messages provided by the broadcaster.

4. Press **EXIT** button to return to TV viewing or press **MENU** button to return to the previous menu.



Option Menu Features

Digital Broadcasting System Captions

- Choose the language you want the DTV/CADTV Captions to appear in.
- Languages can be chosen for digital sources only if they are included on the program.

1. Press the **MENU** button and then use **▲ / ▼** button to select the **OPTION** menu.
2. Press the **▶** button and then use **▲ / ▼** button to select **Caption/Text**.
3. Press the **▶** button and then use **▲ / ▼** button to select available caption languages: **English, Spanish, or French**.
4. Press **EXIT** button to return to TV viewing or press **MENU** button to return to the previous menu.



Caption Option

- Customize the DTV/CADTV captions that appear on your screen.

1. Press the **MENU** button and then use **▲ / ▼** button to select the **OPTION** menu.
2. Press the **▶** button and then use **▲ / ▼** button to select **Caption Option**.
3. Press the **▶** button and then use **◀ / ▶** button to select **Custom**.
4. Use **▲ / ▼** button to customize the Style, Font, etc., to your preference. A preview icon is provided at the bottom of the screen, use it to see the caption language.
 - **Size:** Set the size the words will appear in.
 - **Font:** Select a typeface for the words.
 - **Text Color:** Choose a color for the text.
 - **Text Opacity:** Specify the opacity for the text color.
 - **Bg (Background) Color:** Select a background color.
 - **Bg (Background) Opacity:** Select the opacity for the background color.
 - **Edge Type:** Select an edge type.
 - **Edge Color:** Select a color for the edges.
5. Press **EXIT** button to return to TV viewing or press **MENU** button to return to the previous menu.



ISM (Image Sticking Minimization) Method

- A frozen still picture from a PC/video game displayed on the screen for prolonged periods will result in a ghost image ; even though the image is changed. Use our unique method to minimize any fixed image on the screen.

1. Press the **MENU** button and then use ▲ / ▼ button to select the **OPTION** menu.
2. Press the ► button and then use ▲ / ▼ button to select **ISM Method**.
3. Press the ► button and then use ▲ / ▼ button to select either **Normal**, **White wash**, **Orbiter** or **Inversion** .

- **Normal**

If image sticking is never a problem, ISM is not necessary - set to Normal.

- **White wash**

White Wash removes permanent images from the screen.

Note: An excessive permanent image may be impossible to clear entirely with White Wash. To return to normal viewing, press the any button.

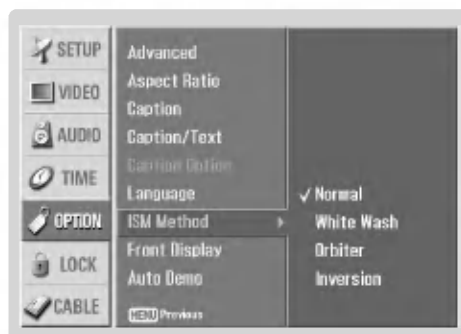
- **Orbiter**

Orbiter may help prevent ghost images. However, it is best not to allow any fixed image to remain on the screen. To avoid a permanent image on the screen, the image will move once per minute: Left → Right → Upside → Downside → Right → Left → Downside → Upside.

- **Inversion**

Inversion will automatically invert the plasma display panel color every 30 minutes.

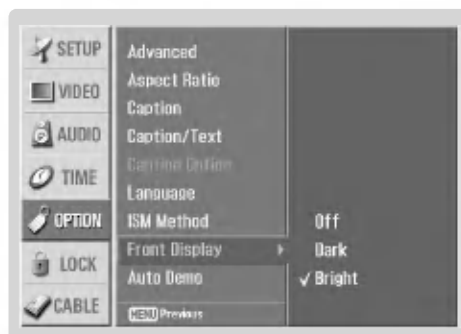
4. Press **EXIT** button to return to TV viewing or press **MENU** button to return to the previous menu.



Front Display

- Illuminates brightly when the set is turned on. The LED displays current TV status.
- This function is only available in models 50/60PY2DR, 50/60PY2DRH.

1. Press the **MENU** button and then use ▲ / ▼ button to select the **OPTION** menu.
2. Press the ► button and then use ▲ / ▼ button to select **Front Display**.
3. Press the ► button and then use ▲ / ▼ button to select **Off**, **Dark** and **Bright**.
4. Press **EXIT** button to return to TV viewing or press **MENU** button to return to the previous menu.



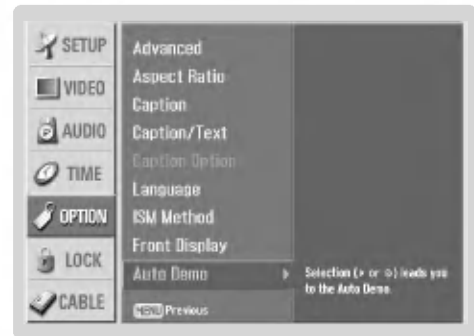
Option Menu Features

Auto Demo

- Displays the slide show to explain the main features of this TV.

1. Press the **MENU** button and then use ▲ / ▼ button to select the **OPTION** menu.
2. Press the ► button and then use ▲ / ▼ button to select **Auto Demo**.
3. Press **EXIT** button to stop Auto Demo.

Note : The images on the Auto Demo may differ from the actual products.



Lock Menu Options

Parental Control can be used to block specific channels, ratings and other viewing sources.

The Parental Control Function (V-Chip) is used to block program viewing based on the ratings sent by the broadcasting station. The default setting is to allow all programs to be viewed. Viewing can be blocked by choosing the type of the program and the categories. It is also possible to block all program viewing for a time period. To use this function, the following must be done :

1. Set ratings and categories to be blocked.
2. Specify a password
3. Enable the lock

V-Chip rating and categories

Rating guidelines are provided by broadcasting stations. Most television programs and television movies can be blocked by TV Rating and/or Individual Categories. Movies that have been shown at the theaters or direct-to-video movies use the Movie Rating System (MPAA) only.

Ratings for Movies previously shown in theaters:

Movie Ratings :

- Blocking Off (Permits all programs)
- G (General audience)
- PG (Parental guidance suggested)
- PG-13 (Parents strongly cautioned)
- R (Restricted)
- NC-17 (No one 17 and under admitted)
- X (Adult only)

If you set PG-13 : G and PG movies will be available , PG-13, R, NC-17 and X will be blocked.

Ratings for Television programs including made-for-TV movies :

- TV-G (General audience)
- TV-PG (Parental guidance suggested)
- TV-14 (Parents strongly cautioned)
- TV-MA (Mature audience only)
- TV-Y (All children)
- TV-Y7 (Children 7 years older)

TV Rating Children:

- Age (applies to TV-Y, TV-Y7)
- Fantasy Violence (applies to TV-Y7)

TV Rating General:

- Age (applies to TV-G, TV-PG, TV-14, TV-MA)
- Dialogue - sexual dialogue (applies to TV-PG, TV-14)
- Language - adult language (applies to TV-PG, TV-14, TV-MA)
- Sex - sexual situations (applies to TV-PG, TV-14, TV-MA)
- Violence (applies to TV-PG, TV-14, TV-MA)

Input Block

- Video, Front Video (On, Off)
- Component 1, 2 (On, Off)
- RGB, HDMI1/DVI,HDMI2 (On, Off)

Lock Menu Options

Parental Lock Setup

- Set up blocking schemes to block specific channels, ratings, and external viewing sources.
- A password is required to gain access to this menu.

1. Press the **MENU** button and then use **▲** / **▼** button to select the **LOCK** menu. Then, press the **▶** button

- Enter the password as requested.
- The TV is set up with the initial password "0-0-0-0".

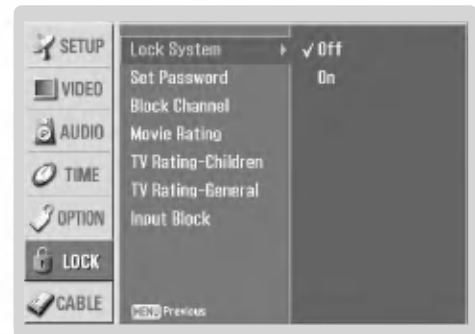
2. Use the **▲** / **▼** button to choose from the following Lock Menu options. Once the option is selected, change the settings to your preference.

- **Lock System:** Enables or disables the blocking scheme you set up previously.
- **Set Password:** Change the password by inputting a new password twice.
- **Block Channel:** Blocks any channels that you do not want to watch or that you do not want your children to watch.
- **Movie Rating (MPAA):** Blocks movies according to the movie ratings limits specified, so children cannot view certain movies. You can set the ratings limit by blocking out all the movies with the ratings above a specified level. Keep in mind that the movie ratings limit only applies to movies shown on TV, not TV programs, such as soap operas.
- **TV Rating-Children:** Prevents children from watching certain children's TV programs, according to the ratings limit set. The children rating does not apply to other TV programs. Unless you block certain TV programs intended for mature audiences in the TV Rating - sub menu, your children can view those programs.
- **TV Rating-General:** Based on the ratings, blocks certain TV programs that you and your family do not want to view.
- **Input Block:** Enables you to select a source to block from the external source devices you have hooked up.

3. Press **EXIT** button to return to TV viewing or press **MENU** button to return to the previous menu.

Note:

- If you ever forget your password, key in '7', '7', '7', '7' on the remote control.



CableCARD™ Function

* In this manual, the OSD (On Screen Display) may be different from your TV's because it is just example to help the TV operation.

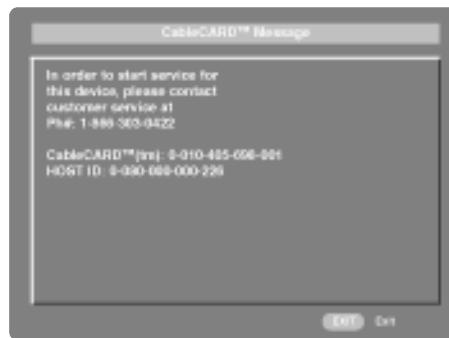
Cable menu options

- The Cable sub menu displays when inserting the CableCARD™ to the TV.
 - The CableCARD™ type is Motorola, Scientific Atlanta (SA), or SCM etc. The OSD (On screen display) is different from your TV according to your CableCARD™ type.
1. Press the **MENU** button and then use **▲ / ▼** button to select the **CABLE** menu.
 2. Press the **▶** button and then use **▲ / ▼** button to select your desired item.
 3. Press the **▶** button.
 4. Press **EXIT** button to return to TV viewing.

In case of Scientific Atlanta CableCARD™



i.e) CableCARD™/ Host ID Screen



- As shown, the pairing number means your TV and CableCARD™ ID. For further information regarding cable TV service, contact your local cable TV service provider(s).

Scrambled channel


- Insert the CableCARD™. If you, it takes about 1 minute to exchange the data between the TV and the CableCARD™. Then, TV screen displays as shown to the right.
- Let your cable TV service provider know the CableCARD™ ID and Host ID.
- If your cable TV service provider is a registered the CableCARD™ ID and Host ID, you can watch premium or high value channel.
- If you ever registered with the cable TV service provider, you can watch premium or high value channel without a message.

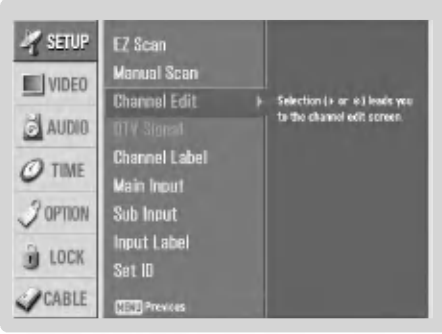



- If the certificates don't match between the TV and the CableCARD™, the OSD (On screen display) displays as shown left.


CableCARD™ Function

Cable Channel List

- 

1. The TV Setup menu is shown with 'Channel Edit' selected. The 'EZ Scan' option is highlighted, and a note indicates that selection leads to the EZ scan screen.
- 

2. The TV Setup menu is shown with 'Channel Edit' selected. A note indicates that selection leads to the channel edit screen.
- 

3. The Cable Channel List screen is shown. It displays a grid of channels with their respective numbers and names. The 'CableCARD' status is indicated as 'CableCARD'.
- 

4. The Cable Channel List screen is shown. It displays a grid of channels with their respective numbers and names. The 'CableCARD' status is indicated as 'CableCARD'.

1. If you enter the **Channel Edit** after running the EZ Scan without CableCARD™, you can see the cable channel list as the picture 3 above.
2. Insert the CableCARD™. Then, the TV receive a new cable channel list which is usually one part channel. It takes about 2~3 minutes to gather the cable channel list after inserting the CableCARD™ as the picture 4 above. (Occasionally more than that time)

Emergency Alert Message

- If an emergency situation occurs during watching the TV/DTV/CATV/CADTV, you can receive a message from cable TV service provider(s).
- When receiving an emergency message, the message is displayed on the screen as shown below or the channel is changed automatically to a channel that maintains the emergency message. The message automatically disappear after some time and return to the last channel.

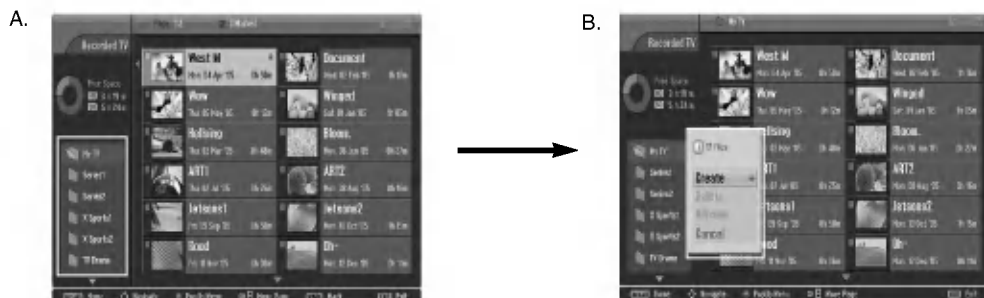




Recorded TV

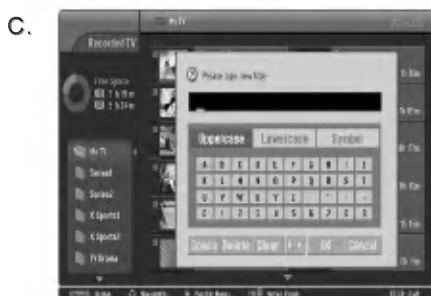
- When you press the **XSTUDIO** button, **HOME** menu is displayed. From here, you can view the recorded program list.
- Or pressing the **REC LIST** button, you can directly enter the recording list.

1. Select the **Recorded TV** in **HOME** menu or press the **REC LIST** button to view the recording list as shown below.



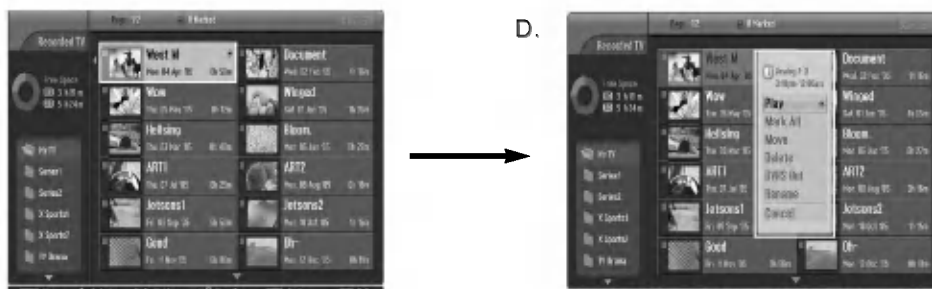
3. Select a desired folder in the folder list and then press the **ENTER** button to view the detailed menu.

- **Create:** Create new folder.
- **Delete:** Delete folder (except 'My TV').
- **Rename:** Edit folder name (except 'My TV').
- **Cancel:** Close the detailed menu.



-> Use the **▲ / ▼ / ◀ / ▶** and **ENTER** button to edit folder name.
-> And then move to the **OK** and press the **ENTER** button to save.

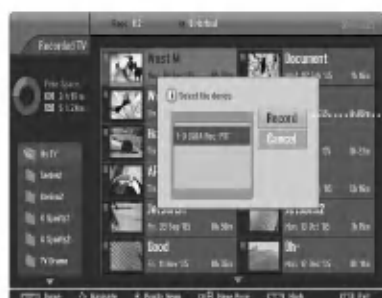
Recorded TV



- The thumbnail recorded list is shown above.

1. Use the **CH ▲ / ▼** button for page up/down navigation.
2. Use the **MARK** button to add or delete from the mark list. A is displayed next to the thumbnail photo if an item is marked.
3. Use **▲ / ▼ / ◀ / ▶** button to navigate the appropriate thumbnail photo, then press the **ENTER** button to open the pop-up menu.

- **Play:** Begin playback of selected recording.
- **Mark All:** mark all photos on the screen.
- **Unmark All:** Change marked photos to unmarked photos.
- **Move:** Move program saved in HDD to other folders.



- Through the 1394, recorded program can be copied to a DVHS device. When a device is not connected to the 1394 port, **"No DVHS Connected"** is displayed on the screen.

- **Delete:** Delete the selected recording.
- **DVHS Out:** When DVHS is connected, selected program is saved to the DVHS.
- **Rename:** Edit recorded program title.
- **Cancel:** Close the Pop-up menu.

4. Repeatedly, press **EXIT** button to return to TV viewing or press **Xenon** button to return to the **HOME** menu.

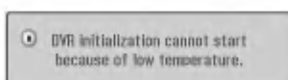


- If the HDD has a problem on performing a function (Recording, Photo, Music) related with DVR, select **Yes** or **No** to initialize HDD as shown below.



- If you select **Yes**, the Recorded List (Recording, Photo, Music) will be deleted. Even If you selects **No**, it can't be worked DVR operation of playback, record etc.

- If temperature is below zero(0°), this message is displayed to initialize HDD as shown below.




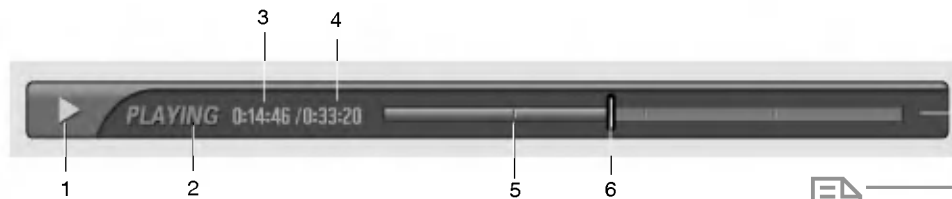
On playing the recorded program, play

- You can play the selected program in the recorded program list.

1. Play a recorded program.

2. While playing, You can see a diversified playback screen as shown below.

- At first, an icon showing current playback mode is displayed as marking . Then press the **ENTER** button to display the progress bar.
- To remove a recorded programs icon, press the **EXIT** button.

















1. Indicates movement of recorded program.
2. Indicates status of recorded program.
3. Indicates elapsed playback time.
4. Indicates total playback time.
5. Indicates a quarter of program runtime.
6. Indicates current playback position.

* The 'Progress Bar'?
This function indicates a possible DVR reshooting section, a current on-screen and real on-broadcasting position, a section of section-recording.

◆ Using the remote control



- You can shift playback to any point while playing the recorded program

	<p>- When playing, press the REW (◀) or FF (▶) button.</p> <ul style="list-style-type: none"> • Like  ->  ->  ->  ->  in a row. 2 times 5 times 20 times 50 times 300 times • If the button is pressed continuously, it changes like above. If the button is taken away, it changes a normal playback.
	<p>(If you do not select a section to repeat)</p> <ul style="list-style-type: none"> - If you wish to return to a initial portion of the playback program, press the ◀◀ button.
	<p>(In the condition of not setting a section to repeat)</p> <ul style="list-style-type: none"> - If you wish to return to a last portion of the playback program, press the ▶▶ button.
	<ul style="list-style-type: none"> - Press the PLAY (▶) button to return to a normal playback.
	<ul style="list-style-type: none"> - During playback, press the Pause () button. • Still screen is displayed. • Repeatedly press the Pause () button to advance frame by frame. • When pressing the Pause () button, longly,  will be shown. • The unit will return to playback in 10 minutes if a button on the remote is not pressed.
	<ul style="list-style-type: none"> • If you press the ▲ / ▼ button while playing, the screen will be jumped back and forth in the current screen. • Pressing the ▲ button, the screen will be jumped about 20 seconds forward. • Pressing the ▼ button, the screen will be jumped about 8 seconds backward.
	<ul style="list-style-type: none"> • After using ▶ button to rewind while playing, press the ◀ button to return to the prior screen.
	<ul style="list-style-type: none"> • If you press the STOP (■) button, you can watch TV.

Recorded TV

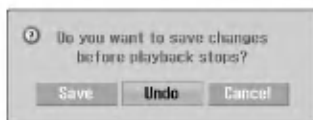
On playing the recorded program, edit a section

- You can save the desired screen in the recorded program list after editing the recorded program.

1. At the point you wish to start , press the  button.
 - The progress bar will show the edited section as red.
 - It can be possible to search (◀◀ or ▶▶), and pause while editing the section.
2. When you wish to stop , press the  button.
 - Stop editing the section.
3. If you repeat from step 1,2, it can be possible to edit some programs.



4. If you press the  button to stop the recorded program playback, this message is displayed as shown below.




- **Save:** Save contents of the edited section and finish the playback of the recorded program.
- **Undo:** Don't save contents of the edited section and finish the playback of the recorded program.
- **Cancel:** The screen returns to playback.

Notes:


- It can be possible to play on the recording / reserved recording
- It can be possible to hear a noise from the hard-disk during playback of the recorded program. The noise is irrelevant the proficiency and creditability of product, the noise occurred more than adequate is the same as good product.
- When saving the content of the edited section, delete the portion not selected.
- When power fails during editing, It can be possible for the program not to be edited. You do press the **STOP (■)** button after checking the recording list.
- Editing the section can be possible to the maximum of 10 files.
- Edits must be more than 10 seconds to be saved.

On playing the recorded program, repeat a section


- You can set the section and repeat the same section of the the recorded program.

1. At the point you wish to start, press the  button.





- At start points, it will appear as marking  .

2. At the point of desired finish, press the  button.

- At finish points, will appear as marking  .
- Repeatedly play the marked section.
- You can not make sections of less than 5 seconds.
- The progress bar which is to be repeated will be showed in blue color.

3. Press the  button to move the position of the start point.

- Return to the start point of marked section and then start the playback.

4. If you press the  or  button to stop playing the repeat section.

Note: It can be possible to search using (Rew / FF), Pause to edit a section while repeating a section.

Notes on Memory Card

What is Memory Card

This is a device equipment to communicate the data between AV external equipment. It's used to a digital camera, camcorder, MP3 player, notebook or PDA.

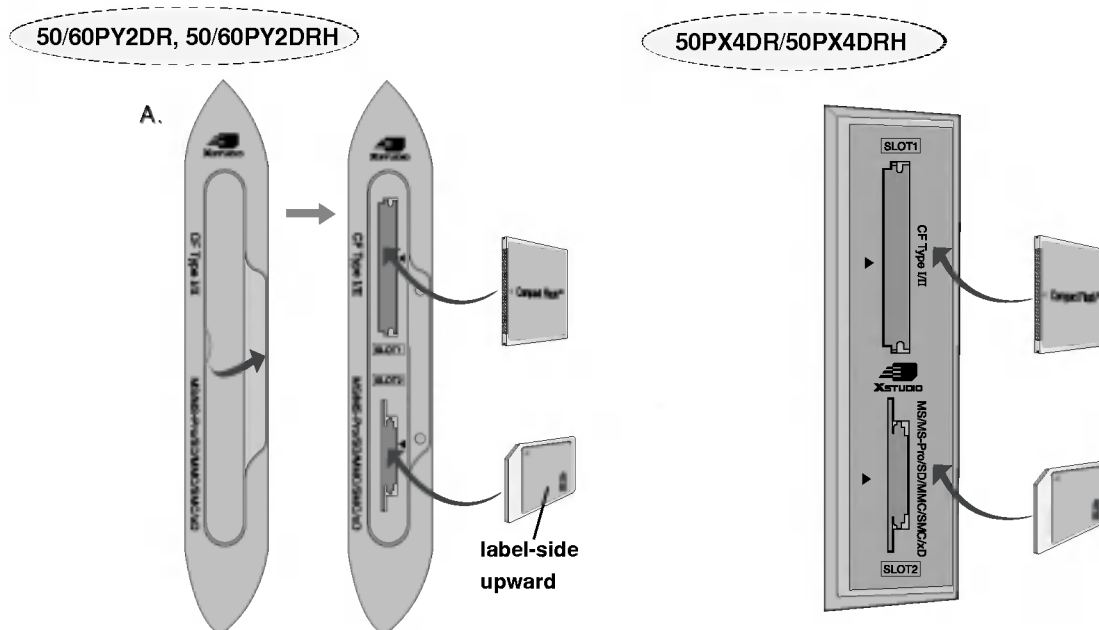
Precaution for Using the Memory Card

- Please be sure to insert the correct memory card type in the right direction.
(Confirm between the two memory slots before insertion.)
- Don't insert the metal substances into the slots of the memory card.
- Do not bend, drop or apply strong shock to memory card.
- After pulling the memory card out from the TV, please keep the memory stick in a appropriate case to prevent it from static shock.
- The stored data may be changed or lost as a result of misuse, static electricity.
- Do not turn the power off while the memory card is in operation.
- Don't eject the memory card while using it. Otherwise, it may cause a data loss or card damage.
- Insert only one card to each slot.
- To prevent a change or loss for stored data, don't misuse the TV or don't let static electricity or electrical noise around the TV.
- This Company takes no responsibility for problems such as the damage or malfunction that occurs while using the TV set, inappropriate TV settings, or any other reasons, except for defects or malfunctions intrinsic to the product.
- Ensure to use a memory card that lists the manufacturers name and serial number.
- The manufacturer will not be responsible for any data damage. Making back up data is strongly recommended.
- Make sure to comply with the following steps when ejecting a memory card.
- Each Memory Card is complied with standard.

Entry Modes- 1.Using the Memory Card / 2. Enter the HOME Menu

1.Using the Memory Card

How to insert and eject the Memory Card

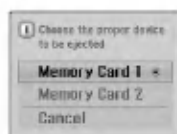


◆ Inserting a Card

1. Insert the Memory Card to Memory card slots of the TV side panel.
2. Two slots support different types of the Memory Cards.
3. If Memory Card is not inserted, each slot is disabled.

◆ Ejecting a card

1. Press the **M/C EJECT** button on the remote control.
2. Select the **Memory Card 1** or **Memory Card 2** based on the inserted card location.
If selecting **Cancel**, removed from the screen.
3. Eject the card with the hand.

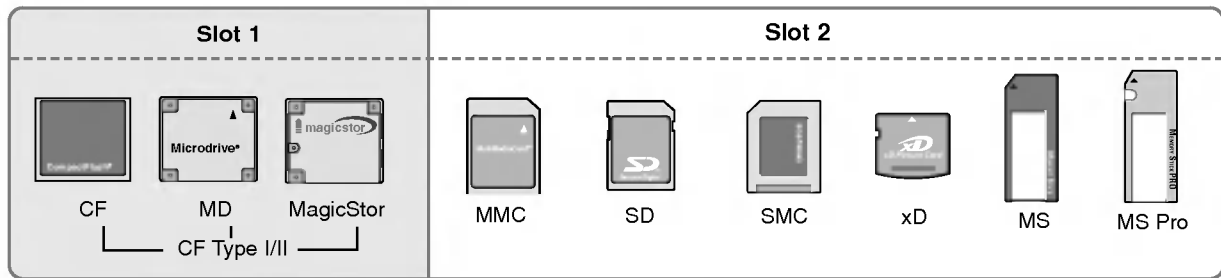


Caution: Press the **M/C EJECT** button of remote control before removing the memory card. Failure to do so may damage the card.

Notes on Memory Card

Memory Card type

- Use the specified card based on the slot location.
- 9 types of Memory Card can be used for this Plasma TV
- Some MagicStor Plus card is not complied with the TV.



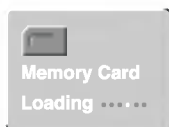
Available file in XSTUDIO^{PRO} mode

A sort of file	Photo Image (JPEG)	Music File (MP3)
Compatibility	*.jpg	*.mp3
Memory card capacity	CF (CompactFlash) : 4GB MD (Microdrive) : 4GB CF+II (MagicStor) : 2.2GB SD (Secure Digital) : 1GB MMC (MultiMedia Card) : 1GB An error may occur if you use a memory card with greater than the specified capacity.	MS (Memory Stick) : 128MB MS Pro (Memory Stick Pro) : 1GB SMC (Smart Media Card) : 128MB xD (Extream Digital Picture Card) : 512MB
Unsupported or damaged file	Unsupported or damaged JPEG or MP3 files can cause errors. Do not try to change the file extension of unsupported file types to the file extension of supported file types.	

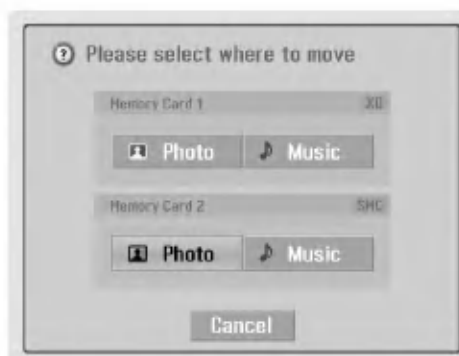
Select the Photo or Music

- When you plug the Memory Card, this screen is displayed, automatically.

B.



C.



1. Press **▲ / ▼ / ◀ / ▶** button to select either **Photo** or **Music** on **Memory Card 1** or **Memory Card 2**.
2. Press **ENTER** button to move to **Photo List/Music List** of the each slot. (Directly move to p.68 (C))

Note: In 30 seconds later, "Loading" message will disappear from the screen.

2. Enter the HOME Menu

Photo List

- When you press the **Source** button, **HOME** menu is displayed.
It's available to playback and copy the Photo file of Memory Card or HDD.
The total storage space of photo file is 10GB.

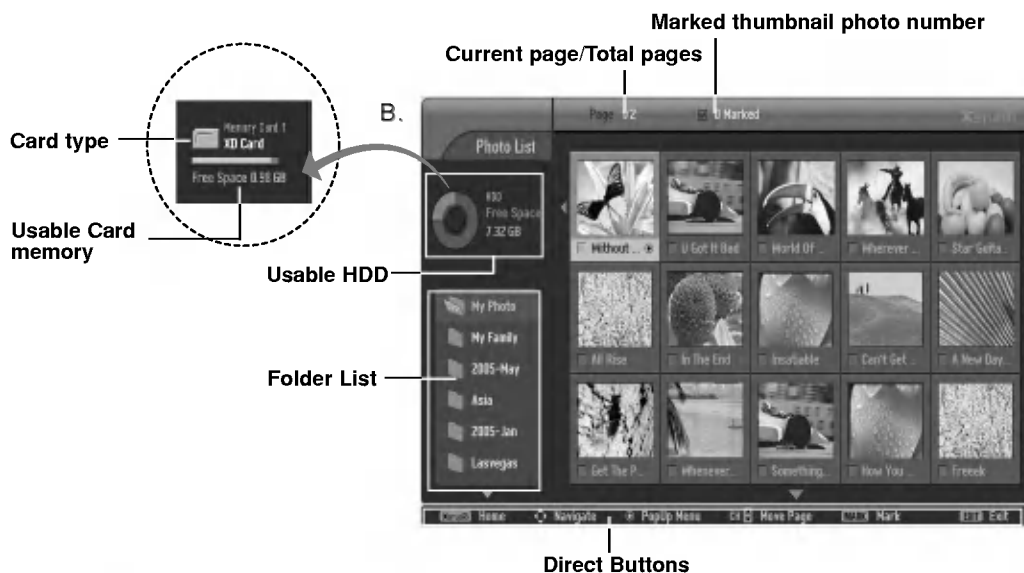
* In this manual, the OSD (On Screen Display) may be different from your TV's because it is just an example to help you with the TV operation.

1. In **HOME** menu, use **▲ / ▼** button and then use the **ENTER** or **▶** button to select the **Photo List**.
2. Use **▲ / ▼** button to select the **HDD/ Memory Card 1/ Memory Card 2** and then you will see a screen filled with thumbnail photos (pic.C,D).

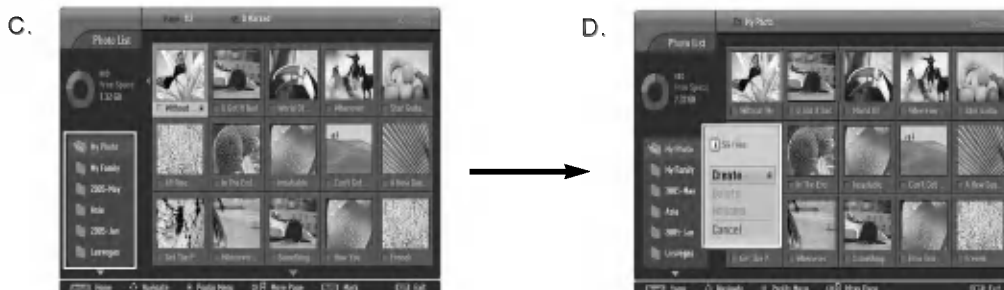


Photo List

Screen Components



Folder List



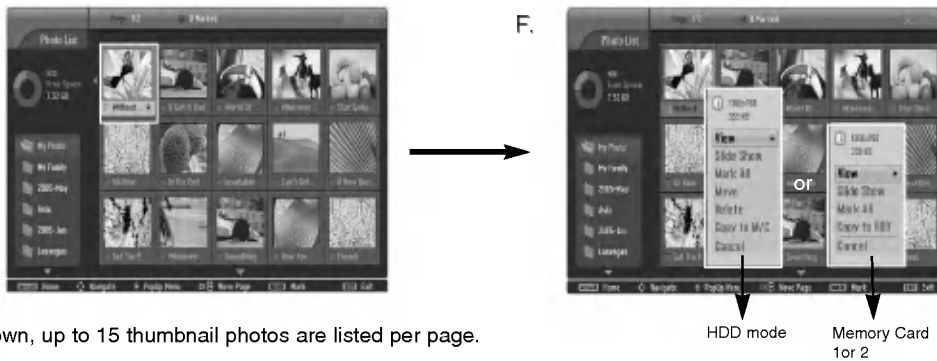
3. Select the desired folder in the folder list and then press the **ENTER** button to view the detailed menu.

- **Create:** Create new folder.
- **Delete:** Delete folder (except 'My Photo')
- **Rename:** Edit folder name.
- **Cancel:** Close the detailed menu.



-> Use the ▲ / ▼ / ◀ / ▶ buttons and then **ENTER** button to select the figures.
-> After editing folder name, select **OK** and press the **ENTER** button to save.

Photo Selection and PopUp Menu



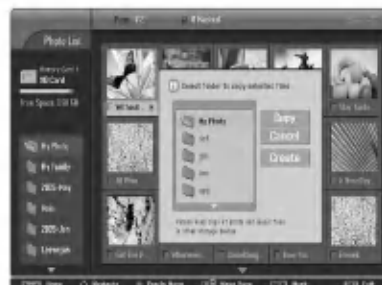
- As shown, up to 15 thumbnail photos are listed per page.

1. Use the **CH ▲ / ▼** button to navigate in the thumbnail photo page.
2. Use **MARK** button to mark or unmark a photo. When one or more photos are marked, you can view or slide show only the marked ones. If no photo is marked, you can view or slide show all photos in the folder.
3. Use **▲ / ▼ / ◀ / ▶** button to navigate the appropriate thumbnail photos, then press the **ENTER** button to show the PopUp menu

- **View:** Display the selected item.
Change from still image to slide show by pressing the **PLAY (▶)** button.
- **Slide Show:** Start a slide show with all photos in the folder. The slide show state can be changed to the view state by pressing the **PAUSE (||)** button. Before starting a slide show, you can choose the slide show interval (3,6 or 9 seconds).
- **Mark All:** Mark all photos on the screen.
- **Unmark All:** Unmark all marked photos.
- **Move:** Only HDD mode, move the selected photo of this folder to another folder.
- **Delete:** This menu is only available in HDD mode.
- **Copy to M/C:** Copy the selected photo in the HDD to the Memory Card.
This menu is only appeared in HDD.



- **Copy to HDD:** Copy the selected photo in the Memory Card to the HDD. At this time, you can also make new folder. This menu is only available in Memory Card mode. And please keep copy of photo and music files in other storage device.



- **Cancel:** Close the pop-up menu.

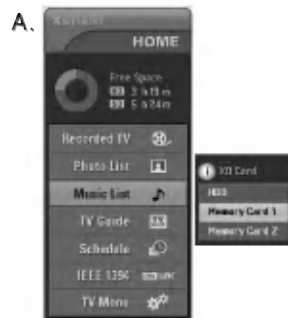
4. Repeatedly, press **EXIT** button to return to TV viewing or press **XtremeUI** button to return to the **HOME** menu.

Music List

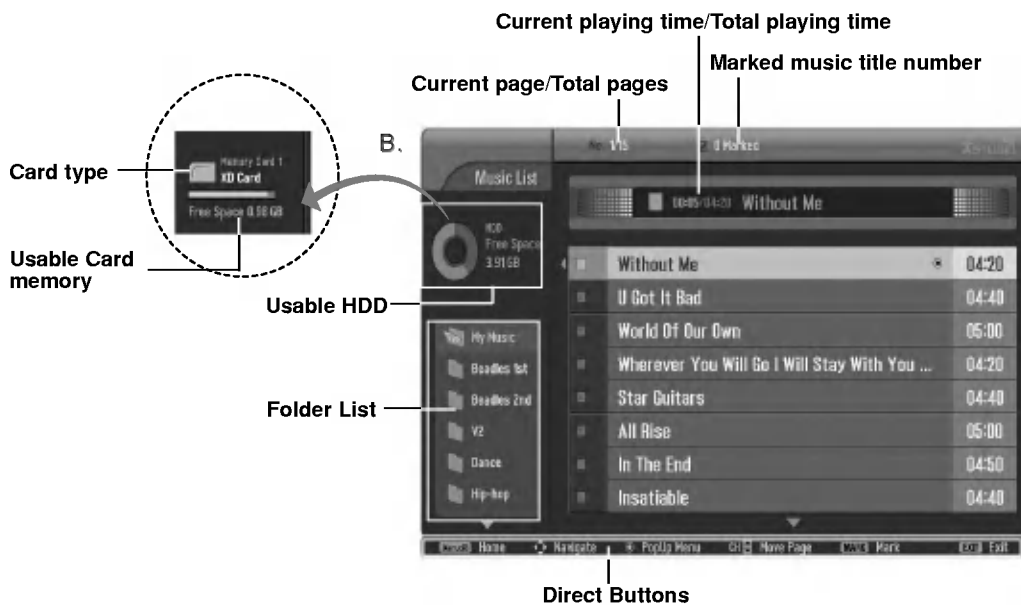
- Purchased MP3/music files may contain copyright restrictions. Playback of these files may not be supported by this model.
- When you press the **Xtreme** button, **HOME** menu is displayed.
It's available to play and copy the Music file of Memory Card or HDD.
The total storage space of music file is 10GB.

* In this manual, the OSD (On Screen Display) may be different from your TV's because it is just an example to help you with the TV operation.

1. Use **▲** / **▼** button and then use the **ENTER** button or **▶** button to select the **Music List**.
2. Use **▲** / **▼** button to select the **HDD/ Memory Card 1/ Memory Card 2** and then you will see a list of music titles (pic.C,D).



Screen Components

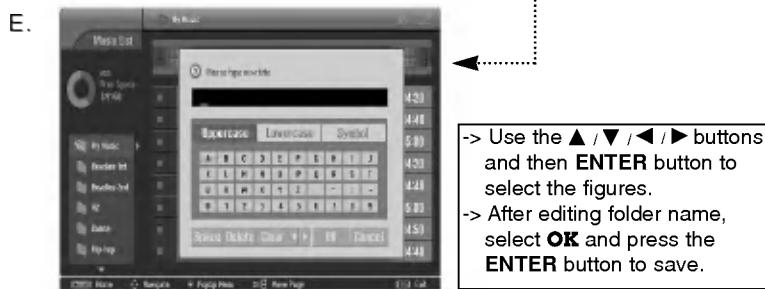


Folder List



3. Select the desired folder in the folder list and then press the **ENTER** button to view the detailed menu.

- **Create:** Create new folder.
- **Delete:** Delete folder (except 'My Music').
- **Rename:** Edit folder name.
- **Cancel:** Close the detailed menu.



Music title Selection and PopUp Menu

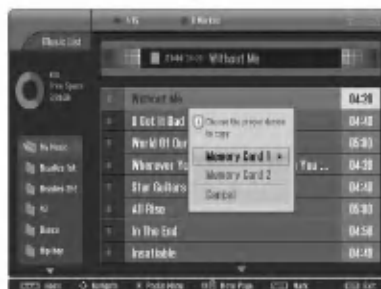


- As shown , up to 8 music titles are listed per page.

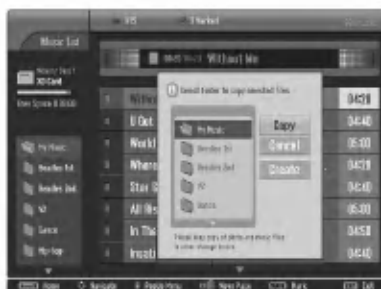
1. Use the **CH ▲ / ▼** button to navigate in the music titles page.
2. Use **MARK** button to mark or unmark a music title. When one or more music titles are marked, the marked music will be played in sequence. For example, if you want to listen to only one music repeatedly, just mark the music only and play it. If no music title is marked, all the music in the folder will be played in sequence.
3. Use ▲ / ▼ / ◀ / ▶ button to navigate the appropriate music titles, then press the **ENTER** button to show up the pop-up menu.

Music List

- **Play:** Play the selected musics.
- **Stop Play:** Stop playback.
- **Play With Photo:** Start playing the selected musics and then move to the Photo List.
- **Mark All:** Mark all musics in the folder.
- **Unmark All:** Unmark all marked musics.
- **Move:** Move the selected musics of this folder to another folder.
- **Delete:** Delete the selected musics. This menu is only available in HDD mode.
- **Copy to M/C:** Copy the selected musics in the HDD to Memory Card.
This menu is only available in HDD mode.



- **Copy to HDD:** Copy the selected musics in the Memory Card to the HDD. At this time, you can also make new folder. This menu is only available in Memory Card mode. And please keep copy of photo and music files in other storage device.



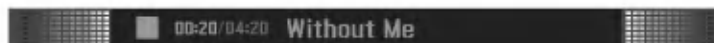
- **Cancel:** Close the pop-up menu.

4. Repeatedly, press **EXIT** button to return to TV viewing or press **Xtreme** button to return to the **HOME** menu.


- If you don't press any button for 40 seconds, the play information box (as shown in the below) will float as a screen saver.



* The 'Screen Saver'?
Screen saver is to prevent screen pixel burning caused by long time still picture.

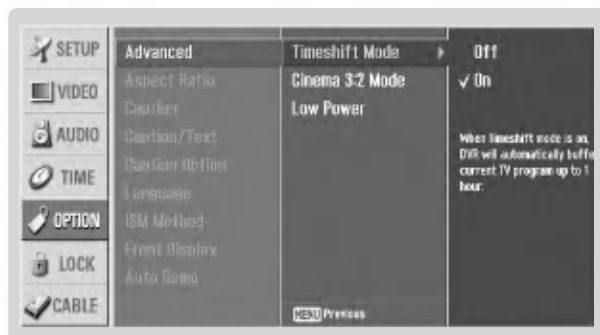


Notes:

- When music is playing,  is displayed in front of the music title.
- If you press any button except **VOL** ▲ / ▼, **MUTE**, **▶**, **||**, **■**, **◀**, **▶▶▶** buttons, screen saver is stopped.
- The **▶**, **||**, **■**, **◀**, **▶▶▶** buttons on the remote control are also available in this mode.

TimeShift

- This function allows the unit to automatically record live TV and make it available for reviewing at any time. With Auto Buffering turned on, you may pause and rewind normal TV viewing at any time without missing any of the live broadcast.

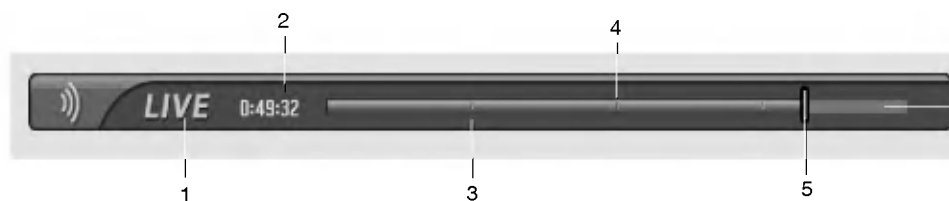


1. Press the **MENU** button and then use **▲ / ▼** button to select the **OPTION** menu.
2. Press the **▶** button and then use **▲ / ▼** button to select **Advanced**.
3. Press the **▶** button and then use **▲ / ▼** button to select the **TimeShift Mode**.
4. Press the **▶** button and then use **▲ / ▼** button to select **On** or **Off**.

Progressing the Timeshift function

1. After selecting the **TimeShift Mode On**, press the **ENTER** button. .

- As soon as Timeshift starts, a progress bar indicating current recording status is displayed in the bottom of the screen. (Timeshift 'Progress Bar' is shown below)
- Press the **EXIT** button to hide the 'Progress Bar'. Pressing the **ENTER** button will display the 'Progress Bar'.
- Stay The TimeShift even change a channel on Timeshift.



* The 'Progress Bar'?
This function indicates a possible DVR reshoving section ,a current on-screen and real on-broadcasting position, a section of section-recording.

1. Indicates status of current displayed video.
2. Indicates current save time.
3. Indicates 15 minute intervals from Timeshift start time. (Total - one hour).
4. Indicates Timeshift elapsed time.
5. Indicates current Timeshift position.

TimeShift

2. When finishing the Timeshift function, enter the **Menu** and then **Timeshift Mode** is to be **Off**.

Notes:

- **DVR (Digital Video Recorder)** : A device which records and plays broadcast program contents onto a hard disk in TV or SET TOP BOX.
- If available hard-disk space is low when TimeShift is initiated, It will disappear automatically from the oldest part.
- In order to save hard-disk space, no storage is done when there is no signal.
- The total storage space of hard-disk is 160GB, there are 10GB minimum reserved for TimeShift.
- When turning power on, it may take up to 3 minutes to initialize the HDD.
- The TimeShift function will not initiate for a copy-protected program.
- Because an analog broadcast is transferred to a digital signal, video that contains rapid movement may show "cross stripes". This happens when the analog signal is compressed and then restored in the digital signal. The unit will attempt to soften the video in order to reduce this effect of excessive picture noise.
- When using the PIP/POP mode, TimeShift is stopped.
- In Video, Front Video, Antenna, Cable sources, TimeShift is available.
- In Audio only channel, TimeShift is not available.

On progressing the Timeshift, play

- On progressing Timeshift, It can do a diversified playing.



Indicates that the current broadcast and displayed video differ.

◆ Using the remote control

- You can shift playback to any point within playing the recorded program


	<p>- When playing, press the REW (◀◀) or FF (▶▶) button.</p> <ul style="list-style-type: none"> • Like -> -> -> -> in a row. 2 times 5 times 20 times 50 times 300 times • If the button is pressed continuously, it changes like above. If the button is taken away, it changes a normal playback.
	<p>- If you wish to return to a initial portion of Timeshift, press the .</p>
	<p>• If you want to return to the current live broadcast, press the button. (Indicator will be changed to LIVE)</p>
	<p>- During playback, press the Pause () button.</p> <ul style="list-style-type: none"> • Still screen is displayed. • Repeatedly press the Pause () button to advance frame by frame. • When pressing the Pause () button, longly, will be shown.
	<ul style="list-style-type: none"> • If you press the / button on playing, the screen will be jumped back and forth in the current screen. • Pressing the button, the screen will be jumped about 20 seconds forward. • Pressing the button, the screen will be jumped about 8 seconds backward.
	<ul style="list-style-type: none"> • After moving the cursor using the / button on playing, the point of the cursor is directly viewed on the screen.
	<p>- Press the PLAY (▶) button to return to a normal playback.</p>

Recording

- This function is able to record channel watched on main screen of an Analog or Digital broadcast.

Instant Record

- This function records the currently displayed channel.

1. Select the desired channel to record while watching program and then press the **RECORD** (●) button.
2. Use the ◀ / ▶ button to select the **OK**, **Options** or **Stop Record** (as shown below in figure A). If you select the **OK**, recording will start as marking,  and recording will begin with basic settings.



3. You can select the **Stop Record** to stop the recording.
4. You can set the duration of the recording by selecting **Options** and then **ENTER** button, then the recording time is displayed. Press the ◀ / ▶ repeatedly to adjust the recording length. Each press of ◀ / ▶ button changes the recording duration in the sequence shown below.
30min -> 1hour -> 1hr 30min -> 2hr -> 2hr 30min -> 3hr



Recording

5. You can also add recording time by pressing the **RECORD** (●) button during Instant Record. Press the ◀ / ▶ repeatedly to add to the recording time. Each press of ◀ / ▶ button changes the recording duration in the sequence shown below.

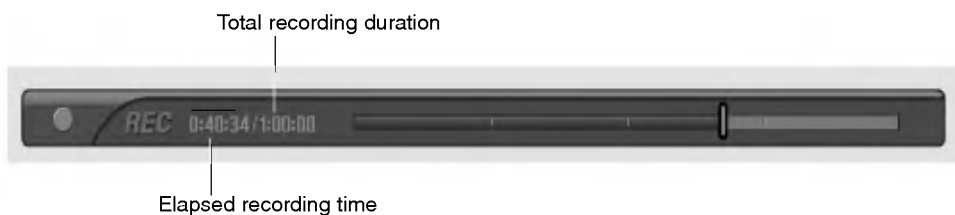
No Change -> +10min -> +20min -> +30min -> +40min -> +50min -> +1hr

The extra recording time added to existing setting value makes final recording time length.

C.



6. After adjusting the recording time, select **OK** and the progress bar will be displayed.



- Press the **EXIT** button to hide the Progress Bar. Press the **ENTER** button to display the progress bar.

7. Press the **STOP** (■) to stop recording, or, when the recording duration is reached, the HD DVR will stop recording. Although recording has stopped, the Timeshift features remain active.

Notes:

- When recording, if the available storage space becomes low, the recording will be automatically stopped.
- Recordings of less than 10 seconds will not be saved.
- To save the disk space while recording analog or digital screen, no data is saved when no signal is present.
- The recording function will not initiate for a copy-protected program.
- After recording, marked time may be somewhat different from actual time.
- In no signal or film source, marked time may be different from actual time.

Watching & Record

- While recording, you can change channels or inputs, without disturbing the recording. And the screen being recorded will be shown in the lower-right corner of the main screen.
1. After starting an Instant Record or Reserved Record, change the channel or input.
 - You can check the screen being recorded in the lower-right corner the main screen (as shown below).
 - Press the **PIP** button to cancel or show the screen being recorded.
 - Press the **SWAP** button to return the screen being recorded in Watch & Record.
 - When changing to the channel being recorded in Watch & Record, screen is changed to Instant Record state or Reserved Record state.



screen being recorded

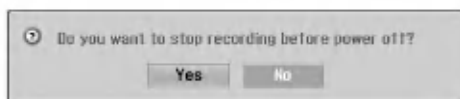
• Watch & Record Input

Record Watch	Digital	Analog	Video	Front Video
Digital	X	0	0	0
Analog	0	0	0	0
Video	0	0	0	0
Front Video	0	0	0	0
Component1	0	0	0	0
Component2	0	0	0	0
RGB-PCDTV	0	0	0	0
HDMI1/DVI	0	0	0	0
HDMI2	0	0	0	0

Note: When digital broadcast is being recorded, another digital broadcast can not be tuned.



- if you turn the power off on recording, this message is displayed as shown below.



- If you selects **Yes**, recording stops and then power is off.
- And if you selects **No**, recording continues and then power is off.

TV Guide On Screen™ System

Overview

- Your new TV contains the TV Guide On Screen Interactive Program Guide.
- The TV Guide On Screen system has features that help you get the most out of your viewing experience.

TV Guide On Screen system Overview

The TV Guide On Screen system has the following features:

- Eight days of show listings (today plus seven days).
- Icons that indicate show rating, stereo, HDTV, new episode, etc.
- Intuitive up/down/left/right navigation using your remote control.
- Set shows to Record.
- Schedule show Reminders.
- Search shows by category (e.g., Movies, Sports, Children, etc.).
- Search for shows based on keywords or alphabetically by title.
- Direct tuning to a channel.
- Show information while watching TV.
- Streamlined System Setup and default setting options.
- Channel lineup customization.
- Help screens while in the TV Guide On Screen system.

Screen Components

- The screens displayed in the TV Guide On Screen system share many of the same components, as shown in the following figure:



- **Video Window** - displays TV video while the TV Guide On Screen system is displayed
- **Service Bar** - provides access to the 4 main Guide Services
- **Current Service Label** - indented to indicate current Service displayed
- **Tile** - displays show title
- **Highlight** - indicates an active tile
- **INFO Box** - provides information for a highlighted item
- **INFO Button** - indicates you can cycle through the various Info Box sizes
- **Channel Logo** - identifies network
- **Record/Remind Icons** - indicates a show is set to Record or set as a Reminder
- **Panel Ad** - location where show- or product-specific information appears (and also where Panel Menu appears)

TV Guide On Screen™ System

Panel Menu



- A Panel Menu appears when the Menu key is pressed on a highlighted tile and additional options are available. It also appears when you press **ENTER** on a show starting in the future.
- When a Panel Menu appears, the highlighted tile changes color to indicate the Panel Menu relates to this tile.
- The Panel Menu displays below the Video Window.
- Help is available for a displayed Panel Menu by pressing the **INFO** button.
- The ▲ / ▼ button move between the options within the Panel Menu.
- The left and right arrows move to adjacent options unless the highlight is on an odometer, where these arrows change the odometer choice.
- Pressing **ENTER** from an odometer or number entry box moves the highlight to the default command button of that Panel Menu, for example, Schedule Reminder.
- Pressing **ENTER** from a highlighted command button executes the action and closes the Panel Menu (e.g., Schedule Reminder, Cancel).
- Select Cancel to cancel any changes and press **ENTER** to close this menu.
- Pressing Menu is a shortcut to Cancel. Press Menu to cancel any changes and close the menu.
- If a Panel Menu contains more menu options than can be displayed on a single screen, ▲ / ▼ button appear at the top or bottom of a menu. Simply scroll down to access these options.

Main Services

Listings

- Access Listings by pressing the TV Guide button on your remote or on the front panel of your TV.
- Listings is always the first Service displayed in the Guide.
- With Listings highlighted, press the Info button to display a Help screen. Press the Info button again to close the screen.

Use the ▲ / ▼ / ◀ / ▶ buttons to move the highlight within Listings to:

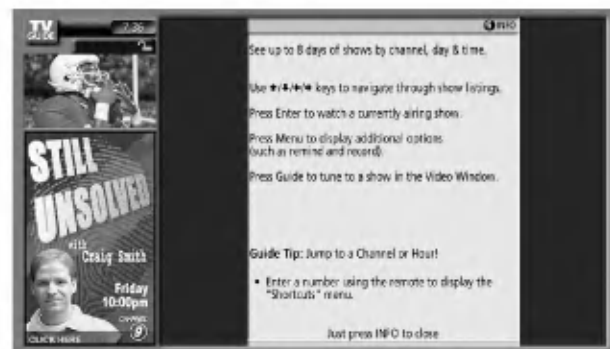
- View 8 days of show listings
- Read show descriptions
- Tune directly to a show currently airing
- Set a show to Remind
- Set a show to Record
- Lock and unlock the Video Window
- Access Panel and Channel Ads

Notes: There may be times when the TV Guide On Screen system could display partial or no program listings. The reasons for this include:

- Program schedule information was not provided to TV Guide On Screen.
- The transmission of the program listings was interrupted.

The phrase "No Listings" will be replaced with program information during the next transmission, which should occur within the next 24 hours.

Please remember to turn off your TV when not in use in order to receive program listings.



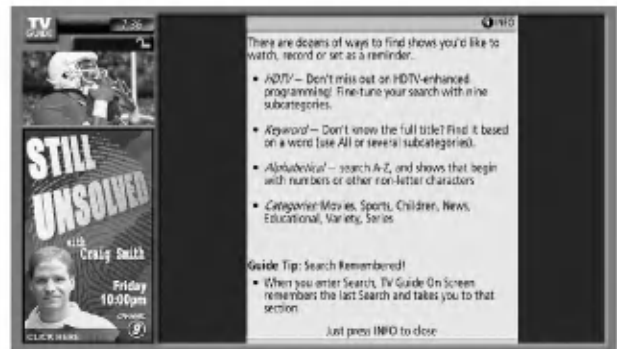
TV Guide On Screen™ System

Search

- Search lets you find shows by category (Alphabetical, Movies, Sports, Children, Educational, News, Variety, Series, HDTV) or by Keyword.
- With Search highlighted, press the Info button to display a Help screen.
Press the Info button again to close the screen.

•Category Search Example: Movies

1. From Search, use the ▼ button to highlight Movies.



2. Use the ▼ button to highlight a subcategory (for example, All).
3. Press **ENTER** to display a list of all Movies, organized by date and time.



4. Highlight a show and press **ENTER** to watch (if on now) or the Menu key to display the Episode Options menu.



You can choose to set a recording, a reminder, or tune to the channel.

Go to Service Bar - closes the menu, changes no information, and returns to the Search Service Bar.

Tune to Channel - exits the TV Guide On Screen system and tunes to the channel of the highlighted show (show airs in the future).

Note: This option reads *Watch Now* if the show is currently airing.

Set Recording - displays the Record Options menu, from which you can set frequency, start and end time, etc.

Set Reminder - displays the Remind Options menu, from which you can set frequency, start time, automatically power On, and auto-tune the TV.

Cancel - closes the menu, changes no information, and returns to the highlighted show.



TV Guide On Screen™ System

• Keyword Search

- **Keyword search** lets you enter a word(s) to look for a particular show by category or for every show title that matches.

1. Highlight the Keyword navigation label, and press **ENTER** button to display the Keyword Search menu.
2. Highlight New Search, and press **ENTER** button.



3. The Search Options menu is displayed.
4. Highlight Category, and use the ◀ / ▶ button to select a category to search (e.g. All, HDTV, Children, Sports, etc.). When finished, use the ▼ button to highlight Enter Keyword.
5. Highlight Enter Keyword, and press **ENTER**.



6. Use the ▲ / ▼ / ◀ / ▶ button to highlight a character, and press **ENTER** to display it. When complete, highlight Done and press **ENTER**.



7. A list of all matching shows for that keyword is displayed.

You can highlight a show, and press **ENTER** to display all airings. You can then highlight a specific listing and press **ENTER** to watch (if On now) or the Menu key to display the Episode Options menu.

From the Episode Options menu, choose to set a recording, a reminder, or tune to the channel, as previously described.



The TV guide on screen system stores all the keywords you create. To edit or delete a keyword, highlight the keyword and press the Menu key. A Search Options menu is displayed.

Go to Service Bar - closes the menu, changes no information, and returns to the Search Service Bar.

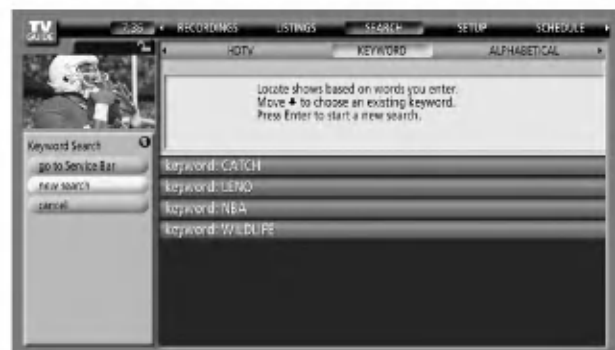
Edit Search - displays the keyboard, where you can change the keyword.

Delete Search - A Confirm menu is displayed.

- **Yes** - deletes the Search

- **No** - closes the panel menu

Cancel - closes the menu, changes no information, and returns to the highlighted show.

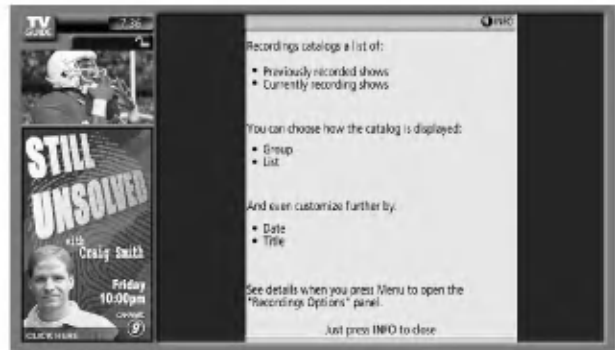


TV Guide On Screen™ System

Recordings

Recordings displays a list of previously recorded or currently recording shows on a DVR.

With Recordings highlighted, press the **INFO** button to display a Help screen. Press the **INFO** button again to close the screen.



Choose the way Recordings are displayed by highlighting Recordings on the Service Bar and then press the **MENU** button to display the Recordings Options menu. Use the **▲ / ▼** buttons to choose between the following:

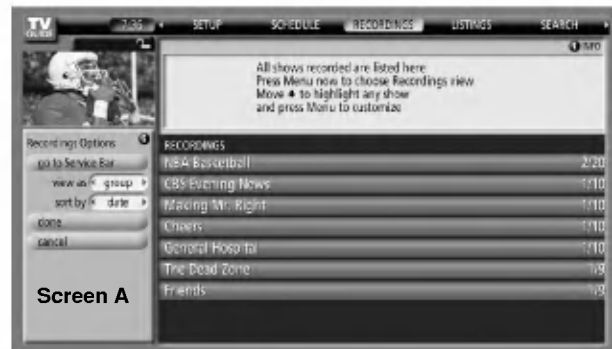
- In View As, use the **◀ / ▶** buttons to choose between
 - ◆ Group - recorded shows are listed without listing every recorded episode (see example in Screen A)
 - ◆ List - displays a complete list of every recorded episode for a show(see example in Screen B)
- In Sort By, use the **◀ / ▶** buttons to choose between
 - ◆ Title - shows are displayed in alphabetical order (see example in Screen A)
 - ◆ Date - shows are displayed by date and time, with most recent date and time first (see example in Screen B)

When finished, press **ENTER** to highlight Done. Press **ENTER** again to close the menu and display the Recordings with the selected options.

In List View, highlight an episode and an Info box provides show information. Press the **MENU** button to display the Episode Options menu.

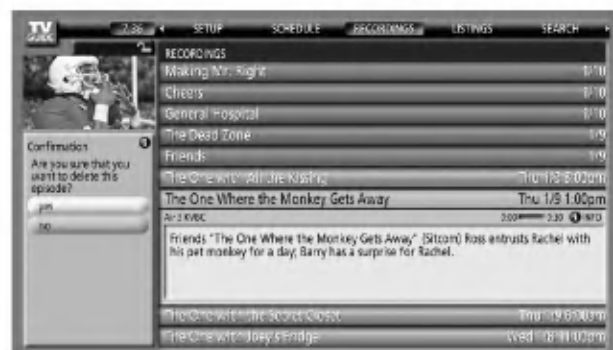
In Group View, highlight a show and press **ENTER** to view a summary for the all the recorded shows along with the episode list (pres **ENTER** again to collapse the episode list).

Highlight a specific episode and press the **MENU** button to display the Episode Options menu.



To view an episode, you can do one of the following:

- Highlight an episode, and press **ENTER** to view it now.
 - ◆ Go to Service Bar - close the menu, changes no information, and returns to the Schedule Service Bar.
 - ◆ Delete Episode - deletes the episode from the Recordings, A Confirm menu is displayed.
 - ◆ Yes - deletes the episode.
 - ◆ No - closes the panel menu.
 - ◆ Cancel - closes the menu, changes no information, and returns to the highlighted show.







TV Guide On Screen™ System

Schedule





- Schedule lets you review, edit, or delete Record and Remind events that you set previously.
- With Schedule highlighted, press the **Info** button to display a Help screen. Press the **Info** button again to close the screen.
- An icon identifies the event type:

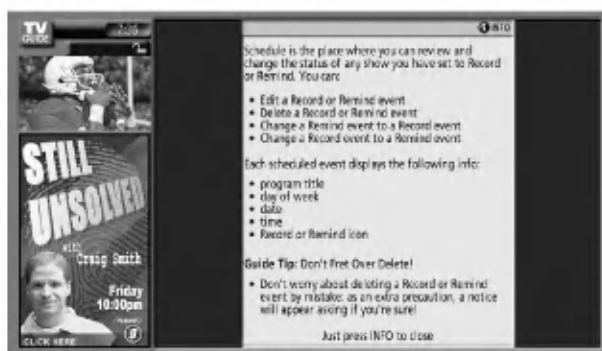
Record

- ◆ Once  —records the show one time
- ◆ Regularly  —records the show every time the show airs on the same channel and starts at the same time
- ◆ Weekly  —records the show each time the show airs on the same day of the week, on the same channel and starts at the same time
- ◆ Off  —keeps the show in the list but will not record this show until the frequency is changed.



Remind

- ◆ Once  —sets a show reminder one time
- ◆ Regularly  —sets a show reminder every time the show airs on the same channel and starts at the same time
- ◆ Weekly  —sets a show reminder each time the show airs on the same day of the week, on the same channel and starts at the same time
- ◆ Off  —keeps the show in the list but will not remind until the frequency is changed



Highlight an event, and press the Menu key for options.

Go to Service Bar - closes the menu, changes no information, and returns to the Schedule Service Bar.

Tune to channel - exits the Guide and tunes to the highlighted show.

Delete Recording - removes the recording from the Schedule, after a Confirm screen.

Edit Recording - opens a menu from which you can change existing recording information.

Set Reminder - opens a menu from which you can set a Reminder for the show (Record is not cancelled).

Cancel - closes the menu, changes no information, and returns to the highlighted show.



Setup

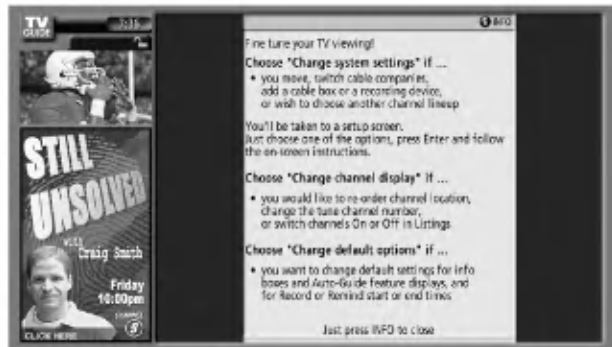
- After you initially complete Guide Setup, you can make changes to Guide settings in the following areas:

- **Change System Settings**
- **Change Channel Display**
- **Change Default Options**

Highlight a choice, press **ENTER**, and follow the on-screen instructions.



With Setup highlighted, press the **Info** button to display a Help screen. Press the **Info** button again to close the screen.



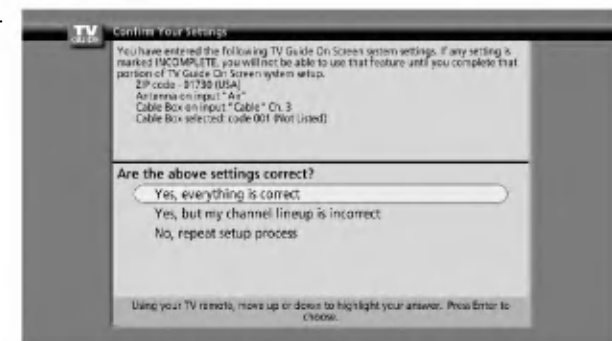
• **Change System Settings**

This option appears after you have completed the initial Guide Setup process.

Press **ENTER** to display the Confirming Your Settings screen. You see your current settings.



Choose one of the options, press **ENTER**, and follow the on-screen instructions.



TV Guide On Screen™ System

• Change Channel Display

Change Channel Display lets you edit channel information that appears in Listings. With Change Channel Display you can :

- Change the position number to indicate where in the Listings the channel displays
- Change the tune channel number
- Switch a channel
 - ◆ On - the channel is always displayed
 - ◆ Off - the channel is never displayed
 - ◆ Auto-Hide - the channel is only displayed when program information is available.



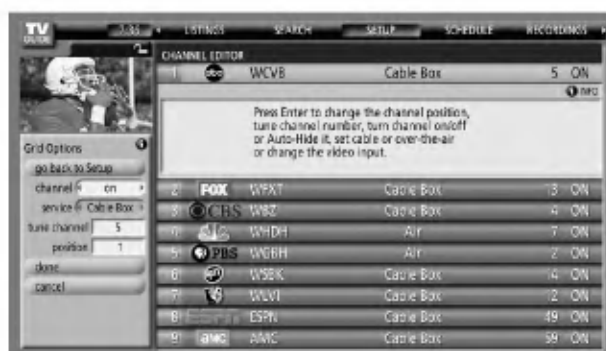
Press **ENTER** to display the Channel Editor screen.

Then, highlight a channel and press Menu. A Grid Options menu is displayed.

Highlight Go Back to Setup to close the menu, change no information, and return to the Setup Service Bar.

Or make changes and when finished, press **ENTER** to highlight Done. Press **ENTER** again to close the menu and accept the changes.

Highlight Cancel to close the menu, change no information, and return to the highlighted channel.



• **Change Default Options**

Change Default Options lets you change default settings in the following categories:

- General Default Options
- Record Defaults
- Remind Defaults

Highlight Change Default Options, and press **ENTER**.



<General Default Options>

General Default Options lets you set defaults for the following:

- The initial Info Box size when the TV guide on screen system is entered.
Choices are No, Small, Large, and Last Used (Default = Last Used).
- The Info Box size rotation when the Info key is pressed while in the TV guide on screen system.
Choices are No only, Small only, Large only, No & Small, No & Large, Small & Large, All (Default = All)
- Automatic entry into the TV guide on screen system (Auto-Guide) when the TV is powered On.
Choices are On and Off (Default = On).

Highlight General Default Options, and press the Menu key to display the General Default Options menu.

Highlight Go to Service Bar to close the menu, change no information, and return to the Setup Service Bar.

When finished, press **ENTER** to highlight Done. Press **ENTER** again to close the menu and accept the changes.

Highlight Cancel to close the menu, change no information, and return to the highlighted option.



TV Guide On Screen™ System

< Record Defaults>

- Record Default Options lets you set defaults for the following:
- When to start the record event. Choices are 120 minutes early to 120 minutes late, to On time. (Default = On time)
- When to end the record event. Choices are 120 minutes early to 120 minutes late, to On time. (Default = On time)
- Recorder choice: Please choose the HDD only. This TV does not support other devices with a recording feature.

Highlight Record Defaults, and press the Menu key to display the Record Default Options menu.

Highlight Go to Service Bar to close the menu, change no information, and return to the Setup Service Bar.



< Remind Defaults>

- Remind Default Options lets you set defaults for the following:
- Power On the TV, if Off, when a Reminder is scheduled. Choices are Yes and No. (Default = No)
 - Automatically tune the TV to the channel (TV must be On), when a Reminder is scheduled. Choices are Yes and No. (Default = No)
 - When to display the reminder screen. Choices are 30 seconds to 15 minutes early, to 30 seconds to 15 minutes late, to On time. (Default = 1 min early)

Highlight Remind Defaults, and press the Menu key to display the Remind Default Options menu.

Highlight Go to Service Bar to close the menu, change no information, and return to the Setup Service Bar.

When finished, press **ENTER** to highlight Done. Press **ENTER** again to close the menu and accept the changes.

Highlight Cancel to close the menu, change no information, and return to the highlighted option.



Record And Remind Features

Record

You can set a show to Record in Listings, Search, and Schedule or change Record settings for a show in Schedule.

There are 3 ways to set a show to Record:

1) Using the Record Button on the Remote





- Press the Record button on the remote to record the show Once with current default settings (Start and End recording On Time). Each time you press the Record button, you change the record frequency (but not the default settings) among Once (default), Regularly, Weekly, Off, and then Cancel.

Note: The proper Record icon appears on the show tile, as the Record button is pressed.

2) From a Panel Menu

- Highlight a show, and press Menu to display the Episode Options menu.
- Highlight Set Recording, and press **ENTER** to display the Record Options menu.
- Highlight the Frequency option, and use the left and right arrows to choose among Once, Regularly, Weekly, and Off, as previously described.
- Recorder choice: Please choose the HDD only. This TV does not support other devices with a recording feature.

Note: Video Window Lock is switched to on or off using PIP button in Listings mode.

- ◆ **Once**  —records the show one time
- ◆ **Regularly**  —records the show every time the show airs on the same channel and starts at the same time
- ◆ **Weekly**  —records the show each time the show airs on the same day of the week, on the same channel and starts at the same time
- ◆ **Off (not cancel)**  —keeps the show in the list but will not record this show until the frequency is changed
- ◆ **Cancel (no icon displayed)**—does not record



TV Guide On Screen™ System

When finished, press **ENTER** to highlight Schedule Recording.

Press **ENTER** again to close the menu. You see a Record icon for the selected frequency next to the show title.

Highlight Cancel to close the menu, change no information, and return to the highlighted show.



3) Manual Recording

- Highlight the Schedule Service label, and press Menu to display the Schedule Options menu.
- Use the **▲ / ▼ / ◀ / ▶** buttons to move through the options. Use the number or Use the **▲ / ▼ / ◀ / ▶** buttons to change the information, as necessary.
- Highlight New Manual Recording and press **ENTER** to display the Record Options menu.



- Current information (i.e., date, start and end times, channel, input) is displayed.
- Recorder choice: Please choose the HDD only. This TV does not support other devices with a recording feature.



- Use the left and right arrows to choose between Once, Daily, Weekly, and Off, as follows.

- ◆ Once **[O]** —records the time, channel, input, recorder combination one time.
- ◆ Daily **[D]** —records the time, channel, input, recorder combination Monday through Friday.
- ◆ Weekly **[W]** —records the time, channel, input, recorder combination once a week on the selected day of the week.
- ◆ Off (not cancel) **[X]** —keeps the time, channel, input, recorder combination in the list without recording until the frequency is changed.

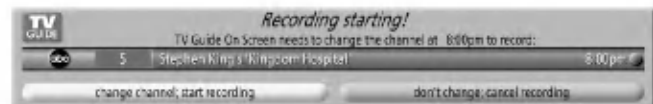


When finished, press **ENTER** to highlight Schedule Recording.

Press **ENTER** again to close the menu. You see a Record icon for the selected frequency next to the show title.

Note: Manual recording is listed by channel number.

Highlight Cancel to close the menu, change no information, and return to the highlighted show.



Before a recording begins, a notification screen appears if your TV is On. At that time, you can choose to start or cancel recording. If the TV is not On, the recording occurs as scheduled. If there is no activity for 3 minutes, the notification screen automatically closes and completes the highlighted item.

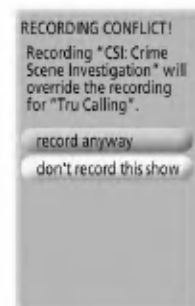
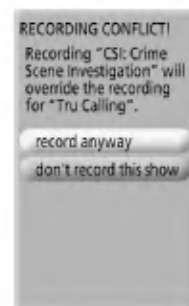
Record Conflict

A conflict message appears for the following reasons:

- a show set to Record overlaps with any part of another show previously set to Record,
- a show set to Record overlaps with a show previously set to auto-tune

Select one of these options:

- ◆ record anyway - this show will override an existing show set to Record or auto-tune
- ◆ don't record this show - cancel the Recording



TV Guide On Screen™ System

Remind

You can set a show Reminder in Listings, Search, and Schedule or change Reminder settings for a show in Schedule. There are 2 ways to set a show Reminder:

1) From a Panel Menu

- Highlight a show, and press Menu to display the Episode Options menu.
- Highlight Set Reminder, and press **ENTER** to display the Remind Options menu.



- Highlight the Frequency option, and use the left and right arrows to choose between:

- ◆ Once —sets a show reminder one time
- ◆ Regularly —sets a show reminder every time the show airs on the same channel and starts at the same time
- ◆ Weekly —sets a show reminder each time the show airs on the same day of the week, on the same channel and starts at the same time
- ◆ Off —keeps the show in the list but will not remind until the frequency is changed



- Power On the TV, if Off, when a Reminder is scheduled. Choices are Yes and No. (Default = No)
- Automatically tune the TV to the channel (TV must be On), when a Reminder is scheduled. Choices are Yes and No. (Default = No)
- When to display the reminder screen. Choices are 30 seconds to 15 minutes early, to 30 seconds to 15 minutes late, to On time. (Default = 1 min early)



When finished, press **ENTER** to highlight Schedule Reminder. Press **ENTER** again to close the menu. You see a Remind icon for the selected frequency next to the show title. Highlight Cancel to close the menu, change no information, and return to the highlighted show.

2) Manual Reminder

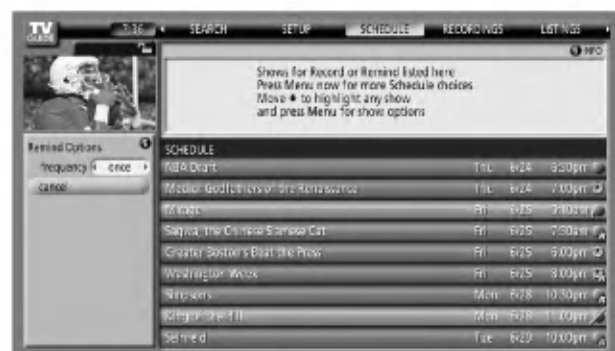
- Highlight the Schedule Service label, and press the Menu key to display the Schedule Options menu.
- Use the ▲ / ▼ / ◀ / ▶ buttons to move through the options. Use the number or ▲ / ▼ / ◀ / ▶ buttons to change the information, as necessary.
- Highlight New Manual Reminder and press the ENTER key to display the Remind Options menu.
- Current information (i.e., date, start and end times, channel, input, frequency, etc.) is displayed.
- Highlight the Frequency option, and use the ◀ / ▶ buttons to choose among Once, Daily, Weekly, and Off, as follows.

- ◆ Once —sets a show reminder for the time, channel, and input combination one time
 - ◆ Daily —reminds for the time, channel, and input combination Monday through Friday
 - ◆ Weekly —sets a show reminder for the time, channel, and input combination once a week on this selected day of the week
 - ◆ Off (not cancel) —keeps the time, channel, input, destination combination in the list without reminding until the frequency is changed
- Power On the TV, if Off, when a Reminder is scheduled. Choices are Yes and No (Default =No).
- Automatically tune the TV to the channel (TV must be On), when a Reminder is scheduled. Choices are Yes and No (Default = No).

When finished, press ENTER to highlight Schedule Reminder. Press ENTER again to close the menu. You see a Remind icon for the selected frequency next to the show title.

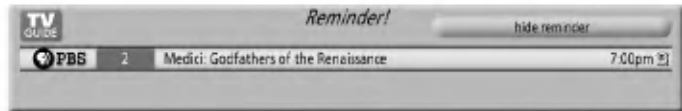
Note: Manual reminder is listed by channel number.

Highlight Cancel to close the menu, change no information, and return to the highlighted show.

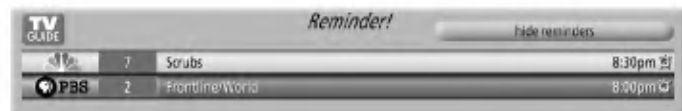


TV Guide On Screen™ System

Based on your option settings, a notification screen will appear, if your TV is On at the reminder time. You can then choose to hide the reminder, or highlight the show, and press **ENTER** to tune to the show. If there is no activity for 3 minutes, the notification screen automatically closes and completes the highlighted item (hide reminders).



If you choose Hide Reminders, the window closes for the show or shows, but does not affect other Reminders you set.



Note: If more than 2 reminders are set for the same time, arrows appear on the Reminder screen. Use the ▲ / ▼ buttons to view the shows.

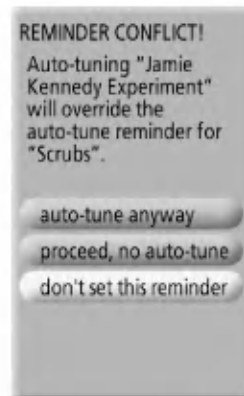
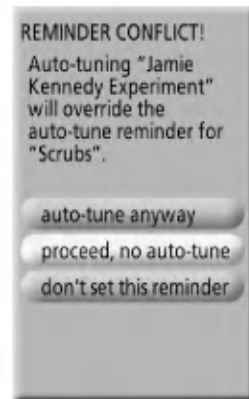
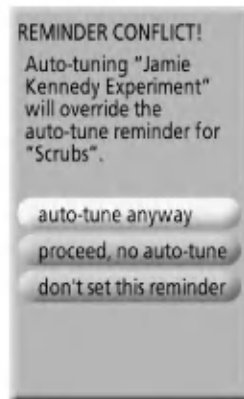
Remind Conflict

A conflict message appears for the following reasons:

- a show set with an Auto-Tune Reminder has the same start time as an existing Auto-Tune Reminder.
- If you are using a cable box, a show set with an Auto-Tune Reminder overlaps with a Recording already scheduled.

Select one of these options:

- ◆ auto-tune anyway - this show will override an existing show set to auto-tune
- ◆ proceed, no auto-tune - set the show as a Reminder but do not auto-tune
- ◆ don't set this reminder - cancel the Reminder




IEEE 1394 Functions

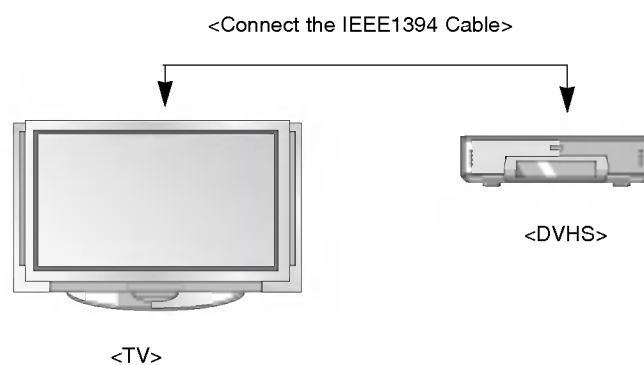
- It's available to communicate to either direction and you can give and take a image, sound, or each control command with one cable.

◆ How to connect the 1394

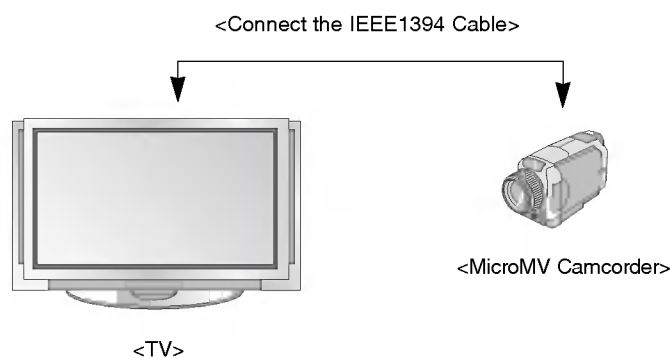
•To operate the IEEE1394, these methods are available as shown below.

1. When connecting the DVHS or the MicroMV Camcorder, as shown in the figure (a) or (b), press the  button to move the **IEEE 1394** in **HOME** menu to show the control panel.

(a) TV  DVHS



(b) TV  MicroMV Camcorder

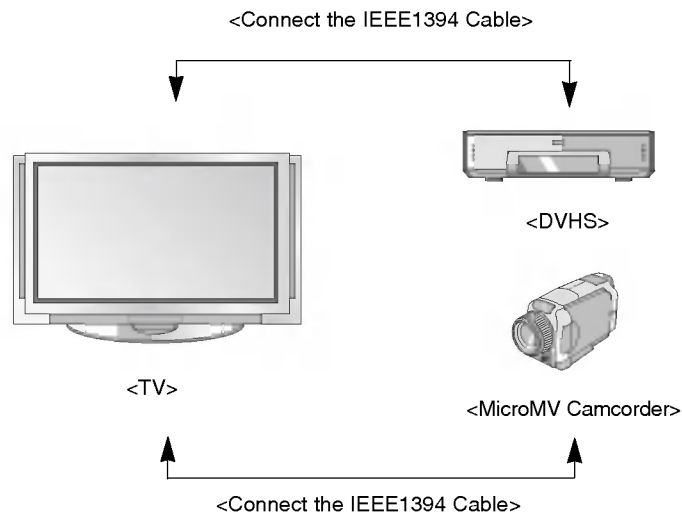


Note: When connecting the DVHS and the MicroMV Camcorder, you may see 'input error' on the MicroMV Camcorder window, it's okay.

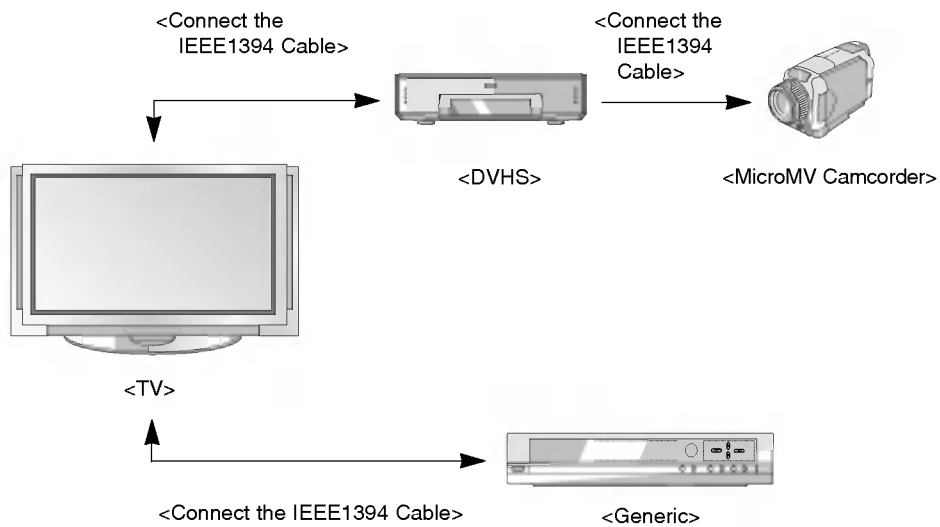
IEEE 1394 Functions

2. When connecting the DVHS and the MicroMV Camcorder, as shown in the figure (c) or (d), press the **Xenium** button to move the **IEEE 1394** in **HOME** menu to show the control panel and then select the DVHS or the MicroMV Camcorder.

(c) TV ◀──▶ DVHS + MicroMV Camcorder



(d) Daisy Chain Connection



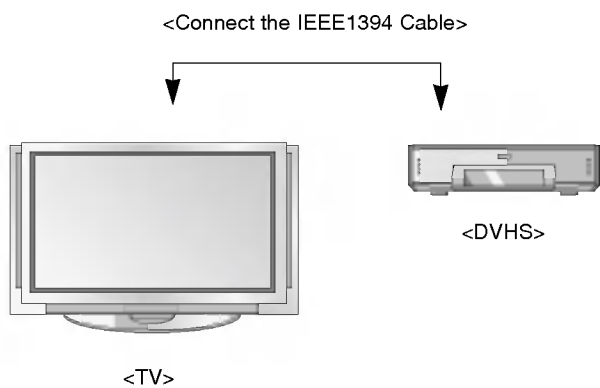
- When connecting the 1394 and then playing, you must use the original DVHS tape. If not, it may not play or have errors.
- If the operation normally doesn't work on Daisy Chain connection, please change an arrangement of connected device.

DVHS

◆ How to play the DVHS

1. Connect the IEEE 1394 jack at the TV to the IEEE 1394 jack at the DVHS with IEEE 1394 Cable.

2. When watching the TV, press the **HOME** button to move the **IEEE 1394** in **HOME** menu and then **ENTER** button.



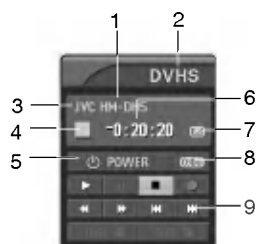
3. Press the **▲** / **▼** buttons to select the **DVHS** and then use the **ENTER** button.

- Show the control panel of DVHS.



IEEE 1394 Functions

- The control panel of DVHS
- Depending on the connected equipment, marked control panel may be different.



1. DVHS Model
 2. Connected Equipment to the 1394
 3. DVHS Company
 4. DVHS Operating Status
 5. Power On/Off
 6. DVHS Play Time
 7. Tape Status
 - Tape shape Icon - Tape in or not
 - Lock shape Icon - Writable or not
 8. Initializing Play Time
 9. DVHS Play, Pause, Stop, Search, Skip, Record, DVR Record, or DVR Stop.
- (Notes:**
- Skip- This function is for a fast search. It searches the program's start point. On skipping, Search (◀▶), Pause (||) and Play (▶) are displayed on the Control Panel. In some models, Skipping is not a option (◀▶) function.

* Supported DVHS List

- JVC(HM-DH40000K)
- JVC(HM-DH40000U)
- JVC(HM-DH5U)
- MITSUBISHI(HV-HD1000)
- PANASONIC(NV-DH2)

Notes:

- In case the DVHS have a incorrect recognition, the power cord of DVHS is completely pulled out and then connected again.
- When searching the screen(◀▶), the DVHS may be strangely seen. And also the DVHS may late respond by devices.

◆ How to play the instant record to the DVHS

1. When watching the TV, press the **XtremeHD** button to move the **IEEE 1394** in **HOME** menu and then **ENTER** button.



2. Press the **▲ / ▼** buttons to select the **DVHS** and then use the **ENTER** button.

• Show the control panel of DVHS.



3. Press the **▲ / ▼ / ◀ / ▶** buttons to move to **●** and then use the **ENTER** button. You can record the current program to the DVHS.

4. Press the **▲ / ▼ / ◀ / ▶** buttons to move to **■** and then use the **ENTER** button.

• Show the control panel of DVHS.



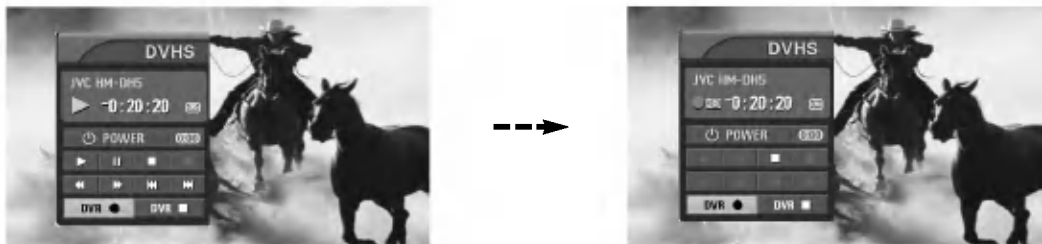
The instant record function can not be used with copy-protected programs.

IEEE 1394 Functions

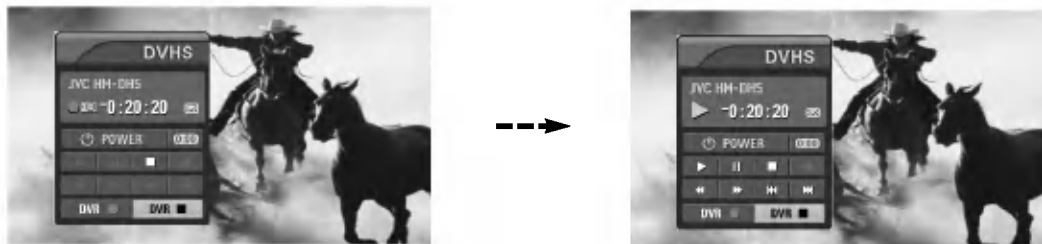
◆ How to save the DVHS to the DVR

1. On playing the DVHS, press the ▲ / ▼ / ◀ / ▶ buttons to move to **DVR ●** and then press the **ENTER** button.

- Save the current screen to the DVR.



2. Press the ▲ / ▼ / ◀ / ▶ buttons to move to **DVR ■** and then use the **ENTER** button to end a saving.



When you save the program which is copy - protected to the DVR, **“This tape is copy-protected”** is display on the screen and will not save to the DVR.

◆ How to save the DVR to the DVHS

1. When press the **RECORD** button, record list is displayed. You can select the wanted program by pressing the **▲ / ▼ / ◀ / ▶** buttons. And then press the **ENTER** button.

2. Select the **DVHS Out** by pressing the **▲ / ▼** buttons and then press the **ENTER** button.



- Press the **▲ / ▼** buttons to select the wanted device and select **Record**.

3. Press the **◀ / ▶** buttons to move to the **START** and then press the **ENTER** button to save to DVHS.

4. Press the **ENTER** button to stop a saving.



- By pressing the **RESUME** button, you can continuously save the recorded contents from a point of stopping time.



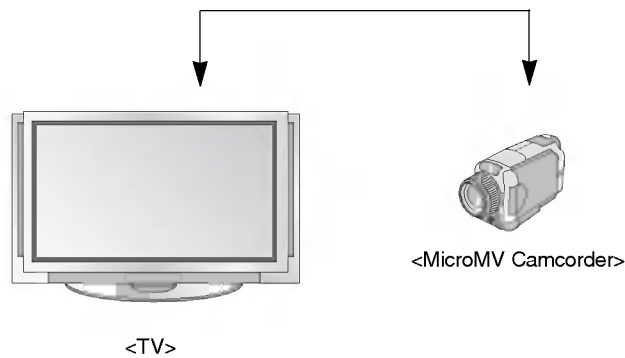
The copy-protected contents couldn't save to the DVHS.

IEEE 1394 Functions

MicroMV Camcorder

◆ How to play the MicroMV Camcorder

1. Connect the IEEE 1394 jack at the TV to the IEEE 1394 jack at the MicroMV Camcorder with IEEE 1394 Cable.



2. When watching the TV, press the **Scene** button to move the **IEEE 1394** in **HOME** menu and then **ENTER** button.

3. Press the **▲** / **▼** buttons to select the **Camcorder** and then use the **ENTER** button.

- Show the control panel of CAM.



- In camera mode of MicroMV Camcorder, this control panel is showed.

- Show the control panel of CAM.

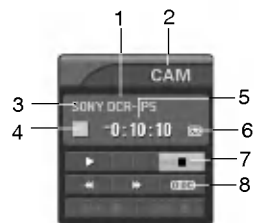
* Supported MicroMV Camcorder List



SONY DCR IP-1
SONY DCR IP-5
SONY DCR IP-45
SONY DCR IP-210

- Press the **TV INPUT** button to stop the IEEE1394 function.

- The control panel of MicroMV Camcorder
-Depending on the connected equipment, marked control panel may be different.



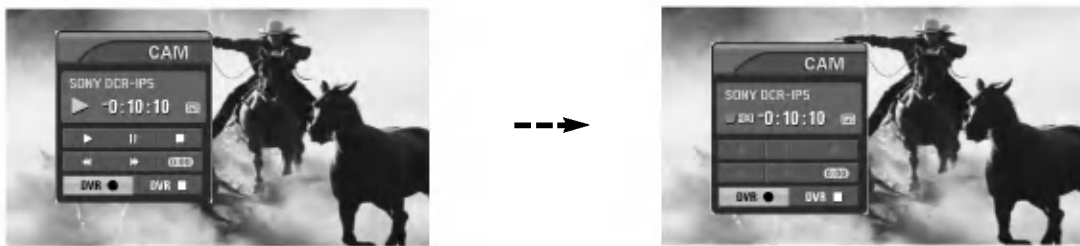
1. MicroMV Camcorder Model
2. Connected Equipment to the 1394
3. MicroMV Camcorder Company
4. MicroMV Camcorder Operating Status
5. MicroMV Camcorder Play Time
6. Tape Status
 - Tape shape Icon - Tape in or not
7. MicroMV Camcorder Play, Search, Record, Stop, Pause, DVR Record, or DVR Stop
8. Initializing Play Time

IEEE 1394 Functions

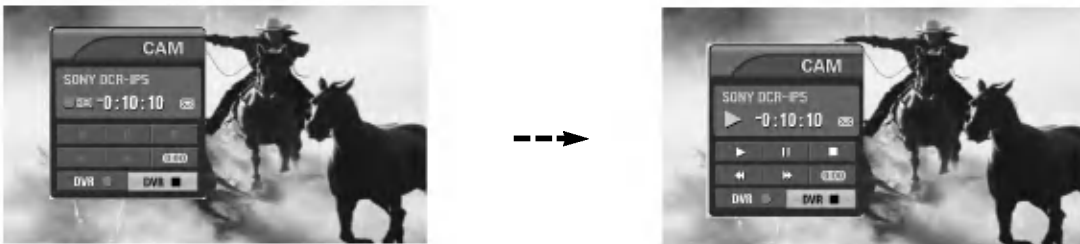
◆ How to save the MicroMV Camcorder to the DVR

1. On playing the MicroMV Camcorder, press the ▲/▼/◀/▶ buttons to move to **DVR ●** and then use the **ENTER** button.

- Save the current screen to the DVR.



2. Press the ◀/▶ buttons to move to **DVR ■** and then use the **ENTER** button to end a saving.



Notes:

- In memory mode of MicroMV Camcorder, it doesn't apply to connect the IEEE1394.
- Regardless of a mode of MicroMV Camcorder, if the tape is ejected, it doesn't apply to connect the IEEE1394.

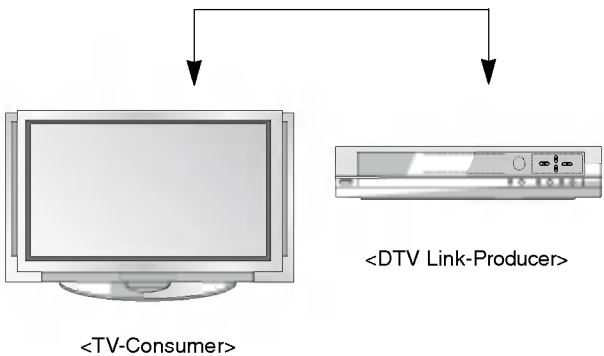
DTV Link : DTV Link applies to 1394 connection of device labeled with DTV Link logo.

* What's the **DTV Link**?
It is normal standard of CEA which controls another unit by a remote and displays OSD a from one unit to the other by using a connection of IEEE1394.

◆ **How to play the DTV Link**

1. Connect the IEEE 1394 jack of the TV to the IEEE 1394 jack of the DTV Link supported device IEEE 1394 Cable.

2. When watching the TV, press the **Xtreme** button to move the **IEEE 1394** in **HOME** menu and then press **ENTER** button.



3. On playing the DTV Link, press the **◀ / ▶** buttons to move to **DVR ●** and then press the **ENTER** button.

4. Press the **ENTER** button to stop a saving.

- Save the current screen to the DVR.



5. Press the **TV INPUT** button to stop the IEEE1394 function.

Notes:

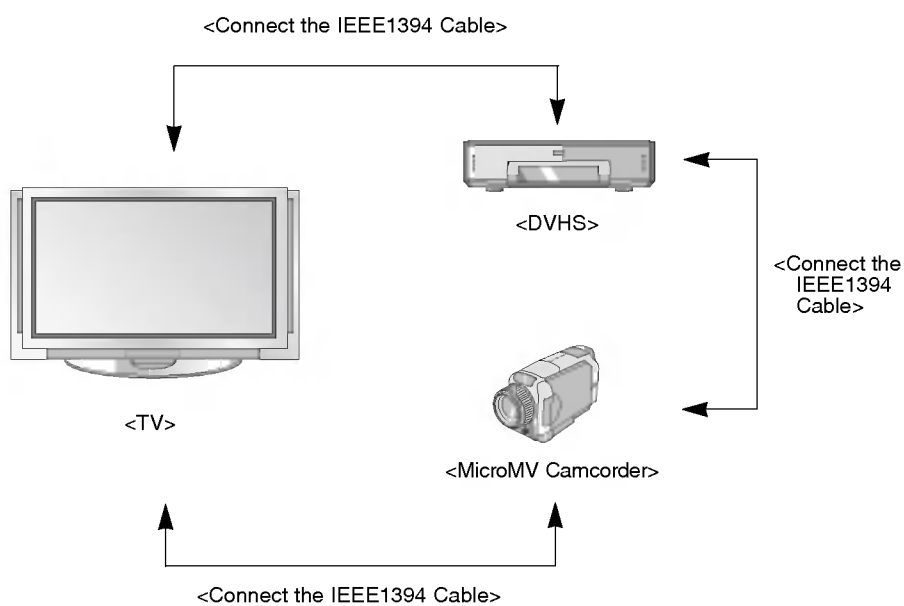
- On a condition of connecting the IEEE 1394, you can control the DTV Link device while watching the OSD through DTV and DTV remote control.
(ex: change of channel, play, record, a show of recording list etc.)
- Analog channel is not supported.
- In case a device outputting MPEG2 TS Data through IEEE1394 port but it doesn't support to DTVLink, you are able to see a screen even if it doesn't control directly on TV.

IEEE 1394 Functions

◆ Don't connect !

- When connecting with these 2 methods, the **IEEE1394 will not work properly.**

(a) LOOP Connection



(b) When connecting the 4 devices and over, the 1394 will not work properly.

Note: When the same devices connect with 2 devices and over, it's undesirable.

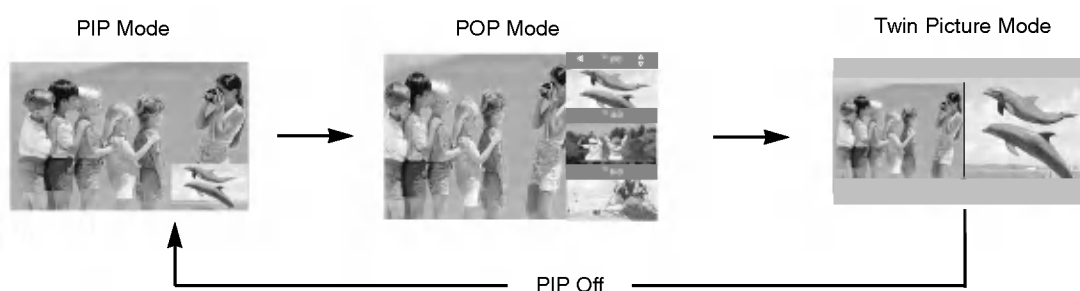
Remote Control

PIP (Picture-In-Picture) / POP / Twin Picture

- PIP lets you view 2 different inputs (sources) on your TV screen at the same time. One source will be large, and the other source will show a smaller inset image.
- Twin Picture mode splits the screen into two images, allowing two picture sources to be shown on the TV screen at the same time. Each source is given half the screen.
- If you set the block/rating for Lock menu options in PIP/Twin Picture mode, "**Rating Blocked**" doesn't display on screen.

Watching PIP/POP/Twin Picture

Press the PIP button to access the sub picture. Each press of PIP changes the PIP options as shown below.



Selecting an Input Signal Source for PIP/Twin Picture

Use the **PIP INPUT** button to select the input source for the sub picture. Each press of **PIP INPUT** button changes the PIP source. You can also select sources for the **Sub Input** in the **SETUP** menu.

Main Picture Source	Available Sub Picture Sources
DTV	Analog, Video, and Front Video
Analog	DTV, Analog, Video, and Front Video

Swapping the PIP/Twin Picture

Repeatedly, use the **SWAP** button to switch the main and sub pictures.

- Component 1, Component 2, RGB-PC (or RGB-DTV), HDMI1/DVI, HDMI2 input sources for the main picture can't be used to swap the main and sub pictures.



TV Program selection for PIP

1. Press the **PIP** button.
2. Select the Antenna or Cable option on the Sub input menu or with the PIP INPUT button. Use the **PIPCH+** / **PIPCH-** button to select a channel for the sub picture.
(You can't select DTV for main and sub picture simultaneously).

Moving the PIP sub picture

In PIP mode, press the ▲ / ▼ / ◀ / ▶ button to move the sub picture to a different location on the screen.



Adjusting Main and Sub Picture Sizes for Twin Picture

Use the ▲ / ▼ / ◀ / ▶ button to change main and sub picture sizes in Twin Picture mode.

i.e)



If screen is adjusted to the maximal size, the large screen is filled with entire screen vertically as shown.

POP (Picture-out-of-Picture: Channel Scan)

Use POP to search the programs of all the memorized channels one-by-one on the 3 PIP screen display, (while the main picture source remains the current channel). The pictures of all the programmed channels are searched with the 3 POP screens.

Notes:

- Run EZ Scan channel search before using POP mode.
- When Sub pictures are changed from the TV/DTV to CATV/CADTV in POP mode, it may make a noise from the Tuner switch.

1. Press the **PIP** button to activate the POP mode while in PIP mode.

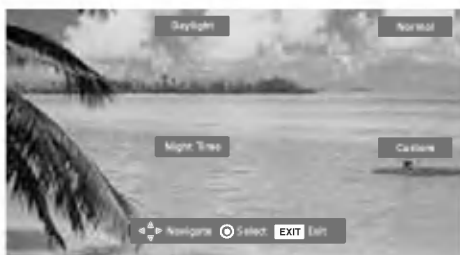
- **Channel selection:** Use ◀ button to enlarge the selected channel being searched on the PIP screen to shift it for viewing on the Main screen.
- **PIP selection:** Use ▲ / ▼ button to select one of 3 PIP screen pictures in POP mode.
- When watching TV/CATV on Main picture, TV/CATV or DTV/CADTV on Sub pictures are in channel scanning. However, when watching DTV/CADTV on Main picture, only TV/CATV on Sub picture is in channel scanning.



2. Press the **EXIT** button to cancel POP mode.

APM (Adaptive Picture Mode)

- Allows a viewer to select their preferred picture mode after comparing the four different picture (**Daylight**, **Normal**, **Night Time** and **Custom**) settings.



1. Press the **APM** button at once. As shown below, the screen is divided to 4-split. Use the **▲ / ▼ / ◀ / ▶** button to navigate 4 EZ Pictures. By pressing the **ENTER** button, you can select the desired mode.



2. Press the **APM** button, again. As shown below, the 4-same screens are displayed. You can easily compare with 4 modes.
3. Use the **▲ / ▼ / ◀ / ▶** button to navigate 4 EZ Pictures. By pressing the **ENTER** button, you can select the desired mode.



4. Press **EXIT** button to return to TV viewing.

Note: While operating the 4-split, any button except **APM**, **ENTER**, **EXIT**, **VOLUME ▲ / ▼**, **MUTE** button on the remote control are not usable.

Brief Info.

- Operation:
- Watching TV/DTV/CATV/CADTV
 - Watching Video, Front Video
 - Watching IEEE 1394
 - In Component1, Component2, RGB, HDMI1/DVI,HDMI2 modes, **INFO** button is not working.

- Function:
- Show the present screen information.
 - On Watching with the upper Input signal, press the **INFO** button.
 - Press the **INFO** button or **EXIT** button to exit.

A: Banner information. Refer to the <Channel Banner>.

B: Program title

C: Day, Month, Year

D: Program start time

E: Show the processing rate

F: Program finish time

G: Current time

H: Added information. Refer to the icon explanation.

I: Program information

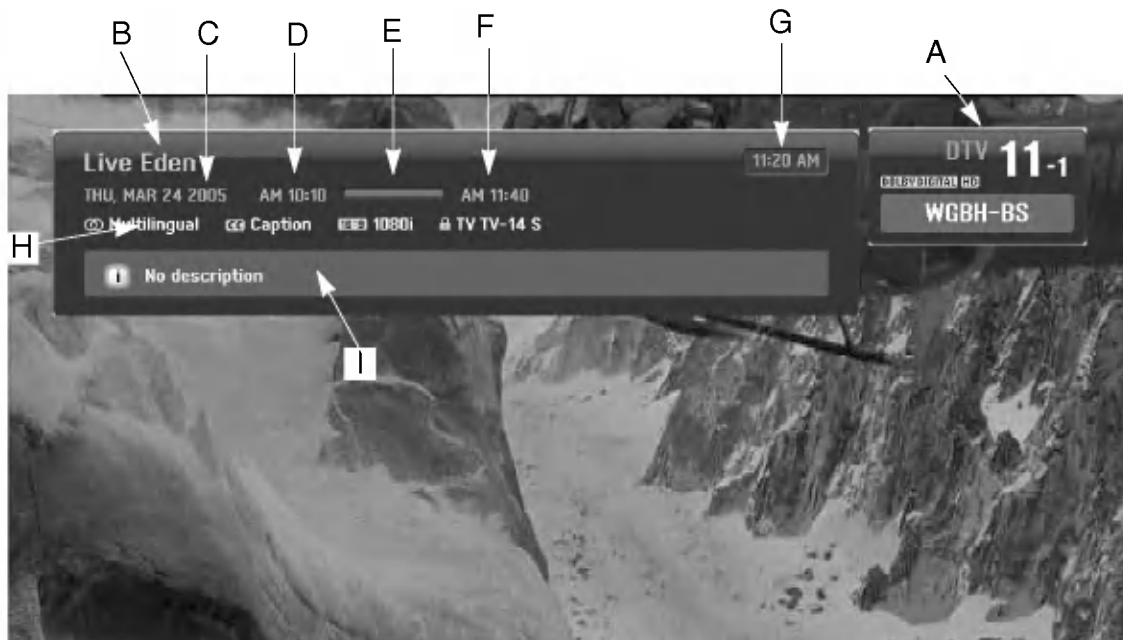
- Screen Ratio of Input Signal 4:3
- Screen Ratio of Input Signal 16:9

- 480i Resolution of Input Signal 720x480i
- 480p Resolution of Input Signal 720x480p
- 720p Resolution of Input Signal 1280x720p
- 1080i Resolution of Input Signal 1920x1080i

Multilingual : Input Signal have over two Audio information. Press the **SAP** button to select wanted Audio.

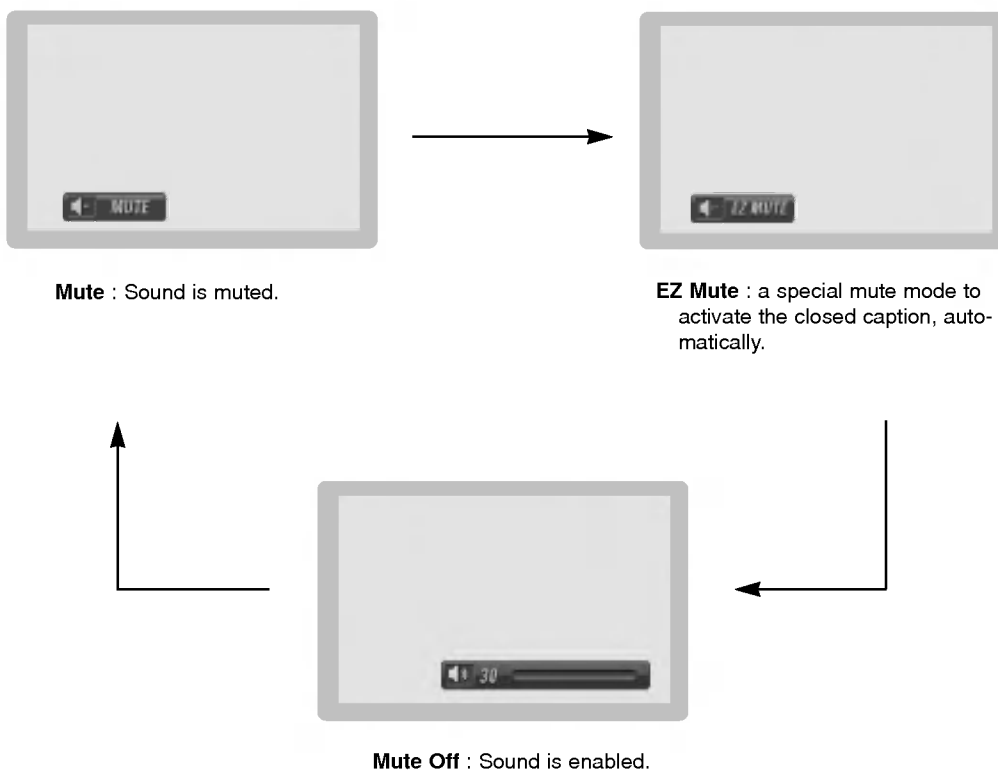
Caption: Input Signal have over one Close service. Press the **CC** button to select wanted Closed caption.

Input Signal have rating information . Refer to the <Lock Menu>.
D (Dialogue), L (Language), S (Sex), V (Violence), FV (Fantasy Violence)



EZ Mute

- Nothing to do with Caption on/Off using **MUTE** button, the mode selected Caption/Text is to be displayed.
- When you repeatedly press the **MUTE** button, the sound mode is changed in turn. (Refer to the picture below)



Note:

- EZ Mute only operates in DTV/Analog/Video/Front Video/IEEE1394.

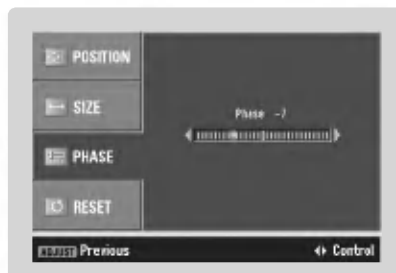
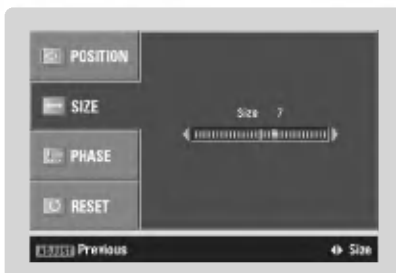
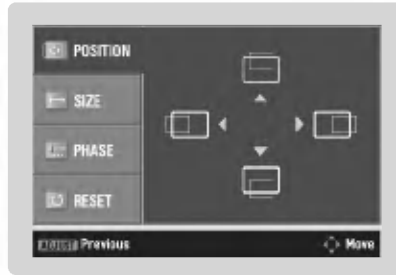
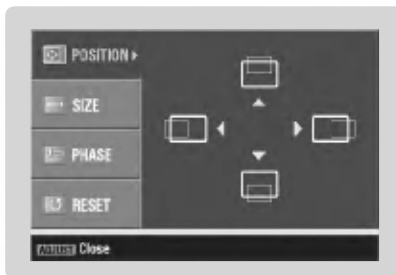
Screen Setup for PC mode

Operation

- When RGB connect to PC output and select the RGB-PC in Main Input, this function is used.
- When HDMI/DVI connect to PC output and select HDMI/DVI input, this function is used.
- In RGB-DTV mode, SIZE and PHASE is not available.

Adjustment for screen Position, Size, Phase, Reset

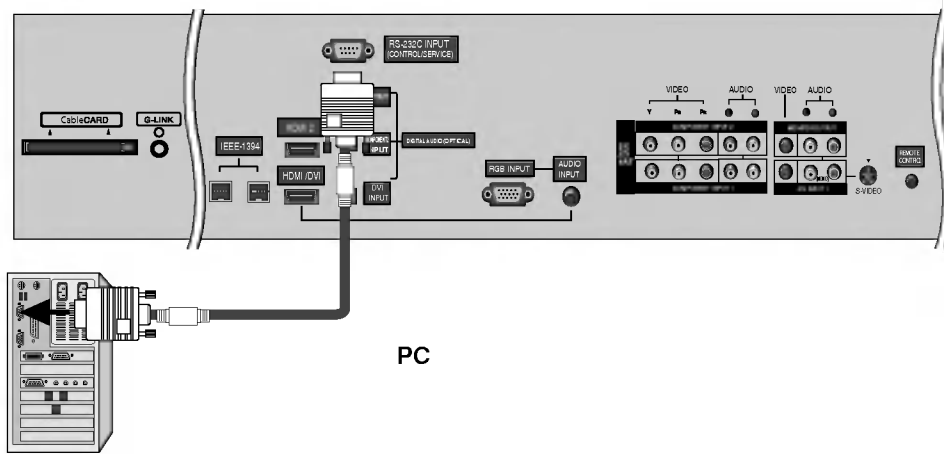
- After connecting RGB-PC or HDMI/DVI to PC output and checking the screen quality.
 - Display PC Adjust Menu using **ADJUST** button.
 - Position : Adjust the screen position. After displaying the Adjust, select the screen position.
 - Size : Adjust the screen size.
 - Phase : Adjust the phase of Pixel clock.
In HDMI/DVI-PC mode, PHASE is not available.
 - Reset : Initializing Size, Position, Phase adjustment .



External Control Device Setup

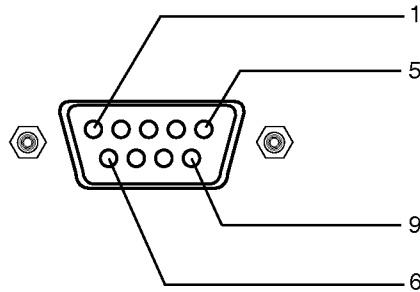
- Connect the RS-232C input jack to an external control device (such as a computer or an A/V control system) and control the Monitor's functions externally.
- Connect the serial port of the control device to the RS-232C jack on the Monitor back panel.
- RS-232C connection cables are not supplied with the Monitor.

RS-232C Setup



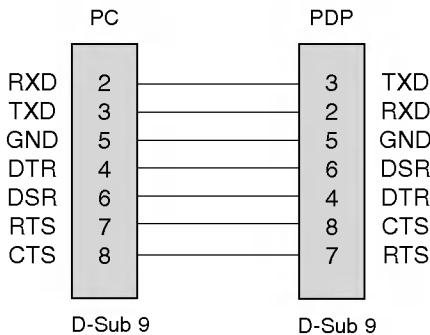
Type of Connector; D-Sub 9-Pin Male

No.	Pin Name
1	No connection
2	RXD (Receive data)
3	TXD (Transmit data)
4	DTR (DTE side ready)
5	GND
6	DSR (DCE side ready)
7	RTS (Ready to send)
8	CTS (Clear to send)
9	No Connection

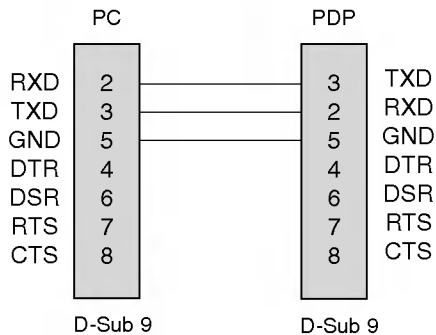


RS-232C Configurations

7-Wire Configurations (Standard RS-232C cable)



3-Wire Configurations (Not standard)



Set ID

Use this function to specify a TV ID number. Refer to 'Real Data Mapping'. See page 119.

1. Press the **MENU** button and then use **▲ / ▼** button to select the **SETUP** menu.
2. Press the **▶** button and then use **▲ / ▼** button to select **SET ID**.
3. Press the **▶** button and then use **▲ / ▼** button to adjust **SET ID** to choose the desired TV ID number. The adjustment range of **SET ID** is 1 ~ 99.
4. Press **EXIT** button to return to TV viewing or press **MENU** button to return to the previous menu.



Communication Parameters

- Baud rate : 9600 bps (UART)
- Data length : 8 bits
- Parity : None
- Stop bit : 1 bit
- Communication code : ASCII code

* Use a crossed (reverse) cable.

Command Reference List

	COMMAND 1	COMMAND 2	DATA (Hexadecimal)
01. Power	k	a	0 ~ 1
02. Input Select	k	b	0 ~ 9
03. Aspect Ratio	k	c	*
04. Screen Mute	k	d	0 ~ 1
05. Volume Mute	k	e	0 ~ 2
06. Volume Control	k	f	0 ~ 64
07. Contrast	k	g	0 ~ 64
08. Brightness	k	h	0 ~ 64
09. Color	k	i	0 ~ 64
10. Tint	k	j	0 ~ 64
11. Sharpness	k	k	0 ~ 64
12. OSD Select	k	l	0 ~ 1
13. Remote Control Lock/Key Lock	k	m	0 ~ 1
14. PIP/Twin	k	n	0,1,2,5
15. PIP Position	k	q	0 ~ 3
16. Treble	k	r	0 ~ 64
17. Bass	k	s	0 ~ 64
18. Balance	k	t	0 ~ 64
19. Color Temperature	k	u	0 ~ 2
20. PIP Input Source	k	y	0 ~ 3
21. ISM Method	j	p	*
22. Low Power	j	q	0 ~ 1
23. Orbiter Time Setting	j	r	1 ~ FE
24. Orbiter Pixel Setting	j	s	1 ~ 3

	COM- MAND 1	COM- MAND 2	DATA 0 (Hexadecimal)	DATA 1 (Hexadecimal)	DATA 2 (Hexadecimal)	DATA 3 (Hexadecimal)	DATA 4 (Hexadecimal)	DATA 5 (Hexadecimal)
25. Channel Tuning	m	a	physical/program high	major/program low	major low	minor high	minor low	attribute
26. Channel Add/Del	m	b	0 ~ 1					
27. Key	m	c	key code					
28. Input Select	x	b	*					
29. PIP Input Select	x	y	*					

Transmission / Receiving Protocol

Transmission

[Command1][Command2][][Set ID][][Data][Cr]

- * [Command 1]: First command to control the set. (j,k,m or x)
- * [Command 2]: Second command to control the set.
- * [Set ID]: You can adjust the set ID to choose desired TV ID number in Setup menu. Adjustment range is 1 ~ 99. When selecting Set ID '0', every connected the TV is controlled. Set ID is indicated as decimal (1~99) on menu and as Hexa decimal (0x0~0x63) on transmission/receiving protocol.
- * [DATA]: To transmit command data.
Transmit 'FF' data to read status of command.
- * [Cr]: Carriage Return
ASCII code '0x0D'
- * []: ASCII code 'space (0x20)'

OK Acknowledgement

[Command2][][Set ID][][OK][Data][x]

- * The TV transmits ACK (acknowledgement) based on this format when receiving normal data. At this time, if the data is data read mode, it indicates present status data. If the data is data write mode, it returns the data of the PC computer.

Error Acknowledgement

[Command2][][Set ID][][NG][Data][x]

- * The TV transmits ACK (acknowledgement) based on this format when receiving abnormal data from non-viable functions or communication errors.

- Data
- 1: Illegal Code
 - 2: Not supported function
 - 3: Wait more time

09. Color (Command2:i)

- ▶ To adjust the screen color.
You can also adjust color in the Video menu.

Transmission

[k][i][][Set ID][][Data][Cr]

Data Min : 0 ~ Max : 64

- Refer to 'Real data mapping'. See page 119.

Acknowledgement

[i][][Set ID][][OK/NG][Data][x]

10. Tint (Command2:j)

- ▶ To adjust the screen tint.
You can also adjust tint in the Video menu.

Transmission

[k][j][][Set ID][][Data][Cr]

Data Red : 0 ~ Green : 64

- Refer to 'Real data mapping'. See page 119.

Acknowledgement

[j][][Set ID][][OK/NG][Data][x]

11. Sharpness (Command2:k)

- ▶ To adjust the screen sharpness.
You can also adjust sharpness in the Video menu.

Transmission

[k][k][][Set ID][][Data][Cr]

Data Min: 0 ~ Max: 64

- Refer to 'Real data mapping'. See page 119.

Acknowledgement

[k][][Set ID][][OK/NG][Data][x]

12. OSD Select (Command2:l)

- ▶ To select OSD (On Screen Display) on/off.

Transmission

[k][l][][Set ID][][Data][Cr]

Data 0: OSD off 1: OSD on

Acknowledgement

[l][][Set ID][][OK/NG][Data][x]

13. Remote Control Lock Mode (Command2:m)

- ▶ To lock the remote control and the front panel controls on the set.

Transmission

[k][m][][Set ID][][Data][Cr]

Data 0: Lock off 1: Lock on

Acknowledgement

[m][][Set ID][][OK/NG][Data][x]

- ▶ If you're not using the remote control and front panel controls on the TV, use this mode. When main power is on/off, remote control lock is released.

14. PIP / POP / Twin Picture (Command2:n)

- ▶ To control the PIP (Picture-in-Picture)/POP/Twin picture.
You can also control the PIP/POP/Twin picture using the PIP button on the remote control.

Transmission

[k][n][][Set ID][][Data][Cr]

Data 0:Off 2: DW1
1: PIP 5: POP4(POP Scan)

Acknowledgement

[n][][Set ID][][OK/NG][Data][x]

15. PIP Position (Command2:q)

- ▶ To select sub picture position for PIP.

Transmission

[k][q][][Set ID][][Data][Cr]

Data 0: Right down on screen
1: Left down on screen
2: Left up on screen
3: Right up on screen

Acknowledgement

[q][][Set ID][][OK/NG][Data][x]

16. Treble (Command2:r)

- ▶ To adjust treble.
You can also adjust treble in the Audio menu.

Transmission

[k][r][][Set ID][][Data][Cr]

Data Min: 0 ~ Max: 64(*transmit by Hexadecimal code)

- Refer to 'Real data mapping'. See page 119.

Acknowledgement

[r][][Set ID][][OK/NG][Data][x]

17. Bass (Command2:s)

- ▶ To adjust bass.
You can also adjust bass in the Audio menu.

Transmission

[k][s][][Set ID][][Data][Cr]

Data Min: 0 ~ Max: 64(*transmit by Hexadecimal code)

- Refer to 'Real data mapping'. See page 119.

Acknowledgement

[s][][Set ID][][OK/NG][Data][x]

18. Balance (Command2:t)

- ▶ To adjust balance.
You can also adjust balance in the Audio menu.

Transmission

[k][t][][Set ID][][Data][Cr]

Data Min: 0 ~ Max: 64(*transmit by Hexadecimal code)

- Refer to 'Real data mapping'. See page 119.

Acknowledgement

[t][][Set ID][][OK/NG][Data][x]

19. Color Temperature (Command2:u)

- ▶ To adjust color temperature.
You can also adjust color temperature in the Video menu.

Transmission

[k][u][][Set ID][][Data][Cr]

Data 0: Medium 1: Cool 2: Warm

Acknowledgement

[u][][Set ID][][OK/NG][Data][x]

20. PIP Input Select (Command2:y)

- ▶ To select input source for sub picture in PIP/Twin picture mode.

Transmission

[k][y][][Set ID][][Data][Cr]

Data 0: DTV
1: Analog
2: Video
3: Front Video

Acknowledgement

[y][][Set ID][][OK/NG][Data][x]

21. ISM Method/Orbiter (Command2:p)

- ▶ To avoid having a fixed image remain on screen.

Transmission

[j][p][][Set ID][][Data][Cr]

Data 1: Inversion
2: Orbiter
4: White Wash
8: Normal

Acknowledgement

[p][][Set ID][][OK/NG][Data][x]

22. Low Power (Command2:q)

- ▶ To control the low power function on/off.

Transmission

[j][q][][Set ID][][Data][Cr]

Data 0: low power off
1: low power on

Acknowledgement

[q][][Set ID][][OK/NG][Data][x]

23. Orbiter Time Setting (Command2:r)

- ▶ To adjust orbiter operation time term.

Transmission

[j][r][][Set ID][][Data][Cr]

Data Min: 1 ~ Max: FE(*transmit by Hexadecimal code),
Unit: Second

Acknowledgement

[r][][Set ID][][OK/NG][Data][x]

24. Orbiter Pixel Setting (Command2:s)

- ▶ To adjust pixel number in orbiter function.

Transmission

[j][s][][Set ID][][Data][Cr]

Data Min: 1 ~ Max: 3

Acknowledgement

[s][][Set ID][][OK/NG][Data][x]

25. Tune Command (Command: m a)

- ▶ To tune channel to following physical/major/minor number

Transmission

[m][a][][Set ID][][Data0][][Data1][][Data2][][Data3][][Data4][][Data5][Cr]

Data 0: Physical Channel Number(Transmit by Hexadecimal code)

NTSC air:02~45

NTSC cable: 01, 0E~7D

ATSC air:01~45

ATSC cable:01~87

Data1,Data2: Major Channel Number (two part)/ Channel Number (One part)

Data1: High byte

Data2: Low byte

Two part channel number: Major number-Minor number

One part channel number: If the channel band is ATSC

digital cable, it can be used. In case of using one part channel number, minor channel does not need.

Data3, Data 4: Minor Channel Number Data3: High byte Data4: Low byte

Data 5:

7	Main/Sub Picture	6	Two/One Part Channel	5	Using Physical Channel	4 Reserved	3	2	1	0	Step
0	Main	0	Two	0	Use	x	0	0	0	0	NTSC Air
1	Sub	1	One	1	No Use	x	0	0	0	1	NTSC Cable
						x	0	0	1	0	ATSC Air
						x	0	0	1	1	ATSC Cable_std
						x	0	1	0	0	ATSC Cable_hrc
						x	0	1	0	1	ATSC Cable_irc
						x	0	1	1	0	ATSC cable_auto
						x	0	1	1	1	Reserved
						x	x	x	x	x	...
						x	1	1	1	1	Reserved

* All data are transmitted by Hexadecimal code

***Two/One part Channel: 6th bit**

This bit is used in a cable-ready system.

***Using physical channel: 5th bit**

If the channel band is NTSC air or NTSC cable, channel tuning can be done by only physical channel. In this case, using physical channel bit must be low(0).

But if the channel band is ATSC air or ATSC cable, there are two cases that physical channel enable or disable.

If the physical channel sending is meaningful, you should set this bit low(0). If the physical channel sending is meaningless, you should set this bit high(1).

Example)

1. Analog channel: NTSC cable, channel number(35), main picture Command: ma 00 23 xx xx xx 01 attribute(0x01): main picture, two part(it's not mandatory), using physical channel, NTSC cable 'xx' data: don't care major and minor channel number in case analog channel tuning.

2. Digital channel: ATSC air, channel number(don't know physical channel, major(30), minor(3)), sub picture Command: ma 00 xx 00 1E 00 03 A2 attribute(0xA2): sub picture, two part, not using physical channel, ATSC air 'xx' data: don't care analog channel number in case digital channel tuning.

3. Digital channel: ATSC air, channel number(physical(20),major(20), minor(3)), sub picture Command: ma 00 14 00 14 00 03 82 attribute(0x82): sub picture, two part, using physical channel, ATSC air.

Acknowledgement

[a][][Set ID][][OK][Data0][Data1][Data2][Data3][Data4][x]
[a][][Set ID][][NG][Data0][x]

26. Channel Add/Del (Command: m b)

► To add and delete the channels

Transmission

[m][b][][Set ID][][Data][Cr]

Data 0: Channel Delete

1: Channel Add

Acknowledgement

[b][][Set ID][][OK/NG][Data][x]

27. Key (Command: m c)

► To send IR remote key code

Transmission

[m][c][][Set ID][][Data][Cr]

Data Key code: Refer to page 124.

Acknowledgement

[c][][Set ID][][OK/NG][Data][x]

28. Input select(Command: x b) (Main Picture Input)

► To select input source for TV.

Transmission

[x][b][][Set ID][][Data][Cr]

Data Structure

DATA(Hex)	INPUT
00	DTV (Antenna)
01	DTV (Cable)
10	Analog (Antenna)
11	Analog (Cable)
20	Video
21	Front Video
40	Component 1
41	Component 2
50	RGB DTV
60	RGB PC
90	HDMI1/DVI
91	HDMI2

Acknowledgement

[b][][Set ID][][OK/NG][Data][x]

29. PIP Input Select(Command: x y)

► To adjust input source for sub picture in PIP mode

Transmission

[x][y][][Set ID][][Data][Cr]

Data Structure

DATA(Hex)	INPUT
00	DTV (Antenna)
01	DTV (Cable)
10	Analog (Antenna)
11	Analog (Cable)
20	Video
21	Front Video

Acknowledgement

[y][][Set ID][][OK/NG][Data][x]

IR Codes

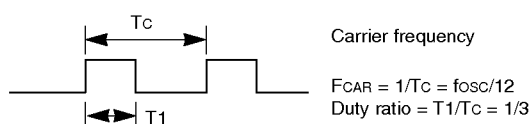
How to Connect

- ▶ Connect your wired remote control to the Remote Control port on the TV.

Remote Control IR Codes

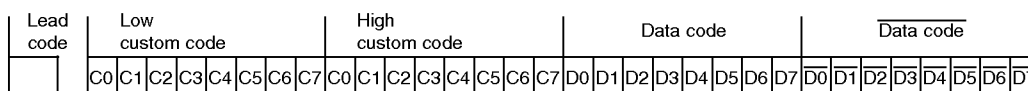
▶ Output waveform

Single pulse, modulated with 37.917KHz signal at 455KHz

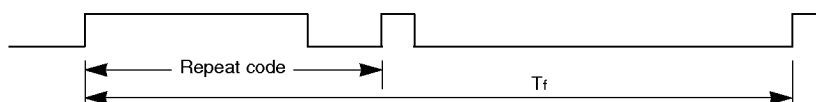


▶ Configuration of frame

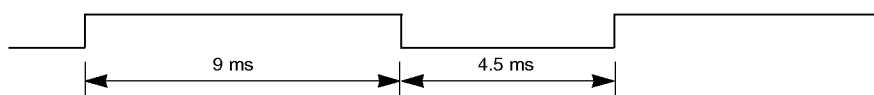
- 1st frame



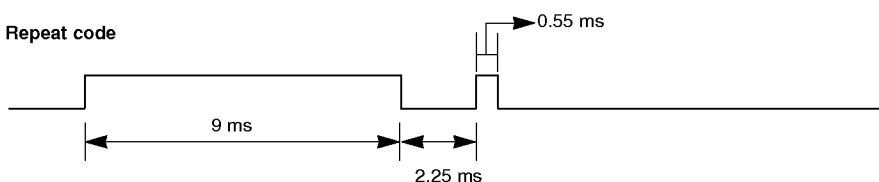
- Repeat frame



▶ Lead code

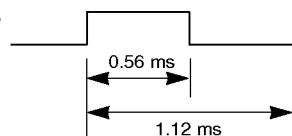


▶ Repeat code

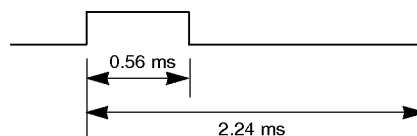


▶ Bit description

- Bit "0"

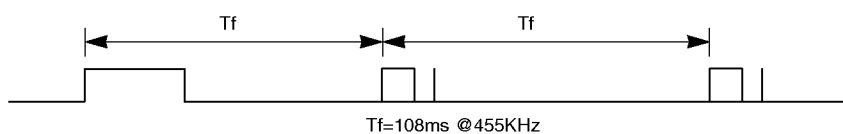


- Bit "1"



▶ Frame interval : Tf

The waveform is transmitted as long as a key is depressed.



Code (Hexa)	Function	Note
0F	TV INPUT	R/C Button
0B	TV/VIDEO	R/C Button
08	POWER	R/C Button (Power On/Off)
79	RATIO	R/C Button
0E	TIMER	R/C Button
10 ~ 19	Number Key 0~ 9	R/C Button
4C	- (Dash)	R/C Button
1A	FLASHBK	R/C Button
09	MUTE	R/C Button
02	VOL ▲	R/C Button
03	VOL ▼	R/C Button
00	CH ▲	R/C Button
01	CH ▼	R/C Button
1E	FAV	R/C Button
AA	INFO	R/C Button
39	CC	R/C Button
40	▲	R/C Button
41	▼	R/C Button
07	◀	R/C Button
06	▶	R/C Button
44	ENTER	R/C Button
43	MENU	R/C Button
52	EZ SOUND	R/C Button
4D	EZ PIC	R/C Button
5B	EXIT	R/C Button
60	PIP	R/C Button
72	PIPCH -	R/C Button
71	PIPCH +	R/C Button
61	PIP INPUT	R/C Button
63	SWAP	R/C Button
0A	SAP	R/C Button
CB	ADJUST	R/C Button
D6	TV	Discrete IR Code (TV Input Selection)
5A	VIDEO	Discrete IR Code (Video Input Selection)
D0	Front Video	Discrete IR Code (Front Video Input Selection)
BF	COMPONENT 1	Discrete IR Code (Component1 Input Selection)
D4	COMPONENT 2	Discrete IR Code (Component2 Input Selection)
D5	RGB-PC	Discrete IR Code (RGB-PC Input Selection)
D7	RGB-DTV	Discrete IR Code (RGB-DTV Input Selection)
C6	HDMI1/DVI	Discrete IR Code (HDMI1/DVI Input Selection)
CC	HDMI2	Discrete IR Code (HDMI2 Input Selection)
76	Ratio 4:3	Discrete IR Code (Only 4:3 Mode)
77	Ratio 16:9	Discrete IR Code (Only 16:9 Mode)
AF	Ratio Zoom	Discrete IR Code (Only Zoom1 Mode)
70	POP	Discrete IR Code (Channel Search)
C4	POWER ON	Discrete IR Code (Only Power On)
C5	POWER OFF	Discrete IR Code (Only Power Off)
B0	PLAY	R/C Button
BA	PAUSE	R/C Button
B1	STOP	R/C Button
BD	REC	R/C Button
8F	REW	R/C Button
8E	FF	R/C Button
B2	GOTOPREV	R/C Button
B3	GOTONEXT	R/C Button
A9	TV GUIDE	R/C Button
92	APM	R/C Button
CA	MC EJECT	R/C Button
80	AUTO DEMO	R/C Button
7C	X STUDIO PRO	R/C Button
7D	MARK	R/C Button
90	REC LIST	R/C Button

Programming the Remote

- ▶ The remote is a multi-brand or a universal remote. It can be programmed to operate most remote-controllable devices of other manufacturers.
Note that the remote may not control all models of other brands.

Programming a code into a remote mode

1. To find out whether your remote can operate the device without programming, turn on the device such as a VCR and press the corresponding mode button on the remote.
After that, press the **POWER** button. If the device is turned off then it responds properly and the remote need not to be programmed. If not, the remote should be programmed to operate the device. The programming procedures are explained below.
2. Press the **MENU** and **MUTE** button continuously at the same time for 2 seconds, the current selected device button will be illuminated.
If you don't press any button for 20 seconds, the light on the mode button will be turned off. In that case, you have to repeat from step 2.
3. Enter code numbers using the number button on the remote by referring the code table on the following pages. When pressing the button, the light blinks at a time. If the device turned off, the programming is successful.
4. Press the **MENU** button to store the code. After blinking twice, this code is stored.
5. Test the remote functions to see if the device responds properly. If not, repeat from step 2.

Programming Codes

VCRs

Brand	Codes	Brand	Codes	Brand	Codes	Brand	Codes
AIWA	034	KENWOOD	014 034 039 043	PORTLAND	108	TATUNG	039 043
AKAI	016 043 046 124		047 048	PULSAR	072	TEAC	034 039 043
	125 146	LG (GOLDSTAR)	001 012 013 020	QUARTZ	011 014	TECHNICS	031 033 070
AMPRO	072		101 106 114 123	QUASAR	033 066 075 145	TEKNIKA	019 031 033 034
ANAM	031 033 103	LLOYD	034	RCA	013 020 033 034		101
AUDIO DYNAMICS	012 023 039 043	LXI	003 009 013 014		040 041 062 063	THOMAS	034
BROKSONIC	035 037 129		017 034 101 106		107 109 140 144	TMK	006
CANON	028 031 033	MAGIN	040		145 147	TOSHIBA	008 013 042 047
CAPEHART	108	MAGNAVOX	031 033 034 041	REALISTIC	003 008 010 014		059 082 112 131
CRAIG	003 040 135		067 068		031 033 034 040	TOTEVISION	040 101
CURTIS MATHES	031 033 041	MARANTZ	012 031 033 067		053 054 101	UNITECH	040
DAEWOO	005 007 010 064		069	RICO	058	VECTOR RESEARCH	012
	065 108 110 111	MARTA	101	RUNCO	148	VICTOR	048
	112 116 117 119	MATSUI	027 030	SALORA	014	VIDEO CONCEPTS	012 034 046
DAYTRON	108	MEI	031 033	SAMSUNG	032 040 102 104	VIDEOSONIC	040
DBX	012 023 039 043	MEMOREX	003 010 014 031		105 107 109 112	WARDS	003 013 017 024
DYNATECH	034 053		033 034 053 072		113 115 120 122		031 033 034 040
ELECTROHOME	059		101 102 134 139		125		053 054 131
EMERSON	006 017 025 027	MGA	045 046 059	SANSUI	022 043 048 135	YAMAHA	012 034 039 043
	029 031 034 035	MINOLTA	013 020	SANYO	003 007 010 014	ZENITH	034 048 056
	036 037 046 101	MITSUBISHI	013 020 045 046		102 134		058 072 080 101
	129 131 138 153		049 051 059 061	SCOTT	017 037 112 129		
FISHER	003 008 009 010		151		131		
FUNAI	034	MTC	034 040	SEARS	003 008 009 010		
GE	031 033 063 072	MULTITECH	024 034		013 014 017 020		
	107 109 144 147	NEC	012 023 039 043		031 042 073 081		
GO VIDEO	132 136		048		101		
HARMAN KARDON	012 045	NORDMENDE	043	SHARP	031 054 149		
HITACHI	004 018 026 034	OPTONICA	053 054	SHINTOM	024		
	043 063 137 150	PANASONIC	066 070 074 083	SONY	003 009 031 052		
INSTANTREPLAY	031 033		133 140 145		056 057 058 076		
JCL	031 033	PENTAX	013 020 031 033		077 078 149		
JCPENNY	012 013 015 033		063	SOUNDESIGN	034		
	040 066 101	PHILCO	031 034 067	STS	013		
JENSEN	043	PHILIPS	031 033 034 054	SYLVANIA	031 033 034 059		
JVC	012 031 033 043		067 071 101		067		
	048 050 055 060	PILOT	101	SYMPHONIC	034		
	130 150 152	PIONEER	013 021 048	TANDY	010 034		

CATV

Brand	Codes	Brand	Codes	Brand	Codes	Brand	Codes
ABC	003 004 039 042	GOLDEN CHANNEL	030		065 085 090	SPRUCER	047 078
	046 052 053	HAMLIN	049 050 055	PIONEER	034 051 052 063	STARCOM	002 004 008 009
AJIN	112	HITACHI	052 055		076	STARGATE	008 030
ANTRONIK	014	HOSPITALITY	070 077	POST NEWS WEEK	016	TADIRAN	030
ARCHER	005 007 014 024	JERROLD	002 003 004 008	PRUCER	059	TAEKWANG	110
CABLE STAR	026		009 010 052 069	PTS	011 048 071 072	TAIHAN	105
CENTURION	092		074		073 074	TANDY	017
CENTURY	007	LG (GOLDSTAR)	001 106 101 005	PULSAR	100	TEXSCAN	029
CITIZEN	007	M-NET	037	RCA	047	TOCOM	039 040 056
COLOUR VOICE	065 090	MACOM	033	REGAL	049 050	TOSHIBA	100
COMBANO	080 081	MAGNAVOX	010 012 064 079	REGENCY	057	UNIKA	007 014 024
COMTRONICS	019 030	MEMOREX	100	REMBRANT	025	UNITED CABLE	004 053
DIAMOND	023	MOVIE TIME	028 032	SAMSUNG	102 107 030 068	UNIVERSAL	005 007 014 024
EAGLE	020 030 040	NSC	015 028 038 071	SCIENTIFIC ATLANTA	003 011 041 042		026 027 032 035
EASTERN	057 062 066		073		043 045 046	VIEWSTAR	012 015 018 086
ELECTRICORD	032	OAK	016 031 037 053	SHERITECH	022		087 088 089
GE	072	PANASONIC	044 047	SIGNAL	030	ZENITH	100 114 060 093
GEMINI	008 022 025 054	PARAGON	100	SIGNATURE	052		
GI	052 074	PHILIPS	006 012 013 020	SL MARX	030		

HDSTB

Brand	Codes	Brand	Codes	Brand	Codes	Brand	Codes
ALPHASTAR DSR	123	GENERAL INSTRUMENT	133 134	PACE SKY SATELLITE	143		088 090 107 130
AMPLICA	050		003 004 016 029	PANASONIC	060 142	TOSHIBA	137
BIRDVIEW	051 126 129	HITACHI	031 059 101	PANSAT	121		002 127
CHANNEL MASTER	013 014 015 018	HOUSTON TRACKER	139 140	PERSONAL CABLE	117	UNIDEN	016 025 042 043
	036 055		033 037 039 051	PHILIPS	071		044 045 048 049
CHAPARRAL	008 009 012 077		057 104	PICO	105		078 079 080 086
CITOH	054	HUGHES	068	PRESIDENT	019 102		101 135 136
CURTIS MATHES	050 145	JANIEL	060 147	PRIMESTAR	030 110 111	VIEWSTAR	115
DRAKE	005 006 007 010	JERROLD	061	PROSAT	072	WINEGARD	128 146
	011 052 112 116	KATHREIN	108	RCA	066 106	ZENITH	081 082 083 084
	141	LEGEND	057	REALISTIC	043 074		091 120
DX ANTENNA	024 046 056 076	LG	001	SAMSUNG	123		
ECHOSTAR	038 040 057 058	LUTRON	132	SATELLITE SERVICE CO	028 035 047 057		
	093 094 095 096	LUXOR	062 144		085		
	097 098 099 100	MACOM	010 059 063 064	SCIENTIFIC ATLANTA	032 138		
ELECTRO HOME	089		065	SONY	103		
EUROPLUS	114	MEMOREX	057	STARCAST	041		
FUJITSU	017 021 022 027	NEXTWAVE	028 124 125	SUPER GUIDE	020 124 125		
		NORSAT	069 070	TEECOM	023 026 075 087		

Audio

Brand	Codes	Brand	Codes	Brand	Codes	Brand	Codes
AIWA	014 028 070 096	JVC	004 013 141	PHILIPS	026 112 143		147 218
	125 129 139 229	KEC	185 186 187	PIONEER	039 042 043 063	TOSHIBA	137
	230	KENWOOD	038 050 067 089		065 091 093 094	THE	061
AKAI	163		170 171 197 206	QUASAR	115 123 127 250	VICTOR	088 131
ANAM	003 014 017 023		215 222	RCA	080	WARDS	089
	059 106 189 216	KOHEL	030	RCX	092	YAMAHA	054 055 066 092
	217 235 236	NAD	045 046	REALISTIC	103 106		199
BURMECTER	252	LOTTE	014 016 036 098	SAMSUNG	124 145 146 182		
CARVER	086		100 172 173 174		193 194 195 203		
CLARION	199		175 176 177 178		204 244 245 246		
DAEWOO	027 053 060 084		179 180 181 183	SANSUI	011 135 138 144		
	102 148 198 221		201 202 208 213	SANYO	019 083 234		
DENON	015 075 130 143		214 219 223 232	SCOTT	106 186		
FANTASIA	071		238 240	SHARP	031 032 051 052		
FINEARTS	022	LXI	103		072 082 117 119		
FISHER	089 099	MAGNAVOX	111		156 184 199 200		
LG(GOLDSTAR)	001 021 024 029	MARANTZ	002 018 020 025	SHERWOOD	206 209		
	087 107 108 110		034 041 081 090	SONY	005 006 158		
	190 191 192 210		097 112		044 045 109 114		
	211 212 239	MCINTOSH	049	TAEKWANG	012 020 073 074		
HAITAI	034 035 188 222	MCS	104		076 077 105 161		
HARMAN/KARDON	068	MEMOREX	107		162 163 164 165		
	037 058 062 069	NAD	046	TEAC	166 167 168 169		
	078 079 095 121	ONKYO	013 040 041 047		205 231 233 242		
	122 149 150 151		048 056 057 132	TECHNICS	010 085 106 136		
	152 153 154 155		133 140		185 187 237		
	157 158 159 160	OPTIMUS	158		101 113 128 134		
	189 207 222 224	PANASONIC	007 033 064 113				
	225 226 227 243		142 220 241 251				
	247	PENNEY	104				

DVD

Brand	Codes	Brand	Codes	Brand	Codes	Brand	Codes
APEX DIGITAL	022	MAGNAVOX	013	PHILIPS	013	SONY	007
DENON	020 014	MARANTZ	024	PIONEER	004 026	THOMPSON	005 006
GE	005 006	MITSUBISHI	002	PROCEED	021	TOSHIBA	019 008
HARMAN KARDON	027	NAD	023	PROSCAN	005 006	YAMAHA	009 018
JVC	012	ONKYO	008 017	RCA	005 006	ZENITH	010 016 025
LG	001 010 016 025	PANASONIC	003 009	SAMSUNG	011 015		

Troubleshooting Checklist

No picture & No sound	<ul style="list-style-type: none">• Check whether the TV is turned on.• Is the power cord inserted into wall power outlet?• Test the wall power outlet, plug another product's power cord into the outlet where the TV's power cord was plugged in.
Picture OK & No sound	<ul style="list-style-type: none">• Press the VOLUME (▶) button.• Sound muted? Press MUTE button.
The remote control doesn't work	<ul style="list-style-type: none">• Check to see if there is any object between the TV and the remote control causing obstruction.• Are batteries installed with correct polarity (+ to +, - to -)? (Refer to p.13)• Correct remote operating mode set: TV, VCR etc.?• Install new batteries. (Refer to p.13)
Picture appears slowly after switching on	<ul style="list-style-type: none">• This is normal, the image is muted during the TV startup process. Please contact your service center, if the picture has not appeared after five minutes.
No or poor color or poor picture	<ul style="list-style-type: none">• Select Color in the Video menu and press the VOLUME (▶) button. (Refer to p.42)• Keep a sufficient distance between the TV and the VCR.• Activate any function to restore the brightness of the picture. (If still picture is on the screen for more than 5 minutes, the screen gets dark.)
Horizontal/vertical bars or picture shaking	<ul style="list-style-type: none">• Check for local interference such as an electrical appliance or power tool.
No output from one of the speakers	<ul style="list-style-type: none">• Adjust Balance in the AUDIO menu. (Refer to p.44)
Unusual sound from inside the TV	<ul style="list-style-type: none">• A change in ambient humidity or temperature may result in an unusual noise when the plasma display is turned on or off and does not indicate a fault with the TV.

Maintenance

- Early malfunctions can be prevented. Careful and regular cleaning can extend the amount of time you will have your new TV. Be sure to turn the power off and unplug the power cord before you begin any cleaning.

Cleaning the Screen

1. Here's a great way to keep the dust off your screen for a while. Wet a soft cloth in a mixture of lukewarm water and a little fabric softener or dish washing detergent. Wring the cloth until it's almost dry, and then use it to wipe the screen.
2. Make sure the excess water is off the screen, and then let it air-dry before you turn on your TV.

Cleaning the Cabinet

To remove dirt or dust, wipe the cabinet with a soft, dry, lint-free cloth. Please be sure not to use a wet cloth.

Extended Absence



If you expect to leave your TV dormant for a long time (such as a vacation), it's a good idea to unplug the power cord to protect against possible damage from lightning or power surges.

Product Specifications

MODELS	50PY2DR-UA/ 50PY2DRH-UA	60PY2DR-UA/ 60PY2DRH-UA	50PX4DR-UA/ 50PX4DRH-UA
Width (inches / mm)	55.9 / 1420	65.6 / 1666	57.5 / 1461
Height (inches / mm)	35 / 889	40.2 / 1022	32.9 / 835
Depth (inches / mm)	14 / 356.8	17 / 434	13 / 331.3
Weight (pounds / kg)	137.8 / 62.5	206.8 / 93.8	123.5 / 56
Resolution	1366 x 768 (Dot)		
Power requirement	AC100-240V ~ 50/60Hz		
Television System	NTSC-M, ATSC, 64 & 256 QAM		
Program Coverage	VHF 2 ~ 13, UHF 14 ~ 69, CATV 1 ~ 135, DTV 2 ~ 69, CADTV 1 ~ 135		
External Antenna Impedance	75 Ω		
Operating Temperature Range	32 ~ 104°F (0 ~ 40°C)		
Operating Humidity Range	Less than 80%		

- The specifications shown above may be changed without prior notice for quality improvement.



**LG ELECTRONICS, INC.
PLASMA TV — U.S. LIMITED WARRANTY**

Your LG Plasma TV will be repaired or replaced in accordance with the terms of this warranty, at LGE's option, if it proves to be defective in material or workmanship under normal use, during the warranty period ("Warranty Period") listed below, effective from the date ("Date of Purchase") of original consumer purchase of the product. This warranty is good only to the original purchaser of the product and effective only when used in the United States, including Alaska, Hawaii, and U.S. Territories.

<p><u>WARRANTY PERIOD:</u></p> <p>LABOR and PARTS: 2 YEARS from the Date of Purchase. Your unit will be repaired or replaced with a new, substitute model or factory reconditioned unit, at LGE's option. If repaired, parts used in the repair may be new or remanufactured.</p> <p>Replacement Units and Repair Parts are warranted for the remaining portion of the original unit's warranty period.</p> <p>EFFECTIVE DATE OF WARRANTY: Your warranty period begins on the date of sale to the original consumer/end user. KEEP THE DEALER'S DATED BILL OF SALE OR PROOF OF DELIVERY as evidence of the purchase date. You will be required to submit a legible copy of your bill of sale or proof of delivery when requesting warranty service.</p>	<p><u>HOW SERVICE IS HANDLED:</u></p> <p>In-Home Service: Please retain dealer's dated bill of sale or delivery ticket as evidence of the Date of Purchase for proof of warranty, and submit a copy of the bill of sale to the service person at the time warranty service is provided.</p> <p>Please call 1-800-243-0000 to locate your nearest LGE Authorized Service Center.</p> <p>Visit our website at: http://www.lgservice.com</p>
---	--

THIS WARRANTY IS IN LIEU OF ANY OTHER WARRANTY, EXPRESS OR IMPLIED, INCLUDING WITHOUT LIMITATION, ANY WARRANTY OF MERCHANTABILITY OR FITNESS FOR A PARTICULAR PURPOSE. TO THE EXTENT ANY IMPLIED WARRANTY IS REQUIRED BY LAW, IT IS LIMITED IN DURATION TO THE EXPRESS WARRANTY PERIOD ABOVE. NEITHER THE MANUFACTURER NOR ITS U.S. DISTRIBUTOR SHALL BE LIABLE FOR ANY INCIDENTAL, CONSEQUENTIAL, INDIRECT, SPECIAL, OR PUNITIVE DAMAGES OF ANY NATURE, INCLUDING WITHOUT LIMITATION, LOST PROFITS, LOST OR CORRUPTED PROGRAMMING OR DATA, OR ANY OTHER DAMAGE WHETHER BASED IN CONTRACT, TORT, OR OTHERWISE. Some states do not allow the exclusion or limitation of incidental or consequential damages or limitations on how long an implied warranty lasts, so the above exclusion or limitation may not apply to you. This warranty gives you specific legal rights and you may also have other rights that vary from state to state.

CONCERNING PIXEL FUNCTIONALITY: Your Plasma TV contains about one million individual pixels. Plasma TV typically contain a small number of pixels that do not function normally. Your display has been inspected and is in compliance with manufacturer's specifications, indicating that any pixel defects do not effect the operation or use of your display.

IMPORTANT: Please fill out and mail in your Product Registration Card or go to www.lgservice.com to register your product online. This information will allow us to reach you promptly should we discover a safety or reliability problem that could affect you.

THIS LIMITED WARRANTY DOES NOT APPLY TO:

<ul style="list-style-type: none">● damage caused in shipping or transit● service required as a result of improper installation, including incorrect or insufficient AC supply (please consult the owner's manual for power supply requirements)● installation or repair of antenna systems, cable converters, cable company supplied equipment, or other components in a video system● set-up or adjustment on consumer controls, or damage caused by improper adjustments● damage caused by other system components● any panel that has been modified or incorporated into any other product● replacement of batteries on the remote control.● damage (including cosmetic damage), failure, loss or personal injury due to misuse, abuse, negli-	<p>gence, improper maintenance or storage, or to acts of nature or other causes beyond our control. (Causes beyond our control include but are not limited to lightning strike, power surges, power outages and water damage.)</p> <ul style="list-style-type: none">● image burn-in● repair or replacement of warranted parts by other than LGE authorized service centers.● units purchased or serviced outside of the coverage area.● product where the original factory serial numbers have been removed, defaced or changed in any way.● product sold and labeled as "as is, where is" or similar disclaimer.
---	--

The cost of repair or replacement under these excluded circumstances shall be borne by the consumer.

CUSTOMER INTERACTIVE CENTER NUMBERS:

<p>To obtain customer assistance, product information or Dealer or Service locations</p>	<p>Call 1-800-243-0000 24 hours a day, 365 days per year</p>
---	---

FOR SERVICE:

Before you call for warranty service, check your operating guide – you may avoid a service call.

For warranty service information, please contact the LGE Customer Interactive Center telephone number.

When calling for service, **please have your product model number, serial number and the date of purchase or the date of original installation available.**

If a replacement unit is required, under some circumstances you may be asked to provide a reserve deposit to the LGE Service Center against a credit card number as surety for advanced shipment. Your credit card will not be charged if you return the defective unit within 10 working days.

If a replacement unit is received, please use the carton and packaging from that unit in returning the defective unit to the LG®Brand Service Center.

Parts and service in accordance with the LGE warranty are LGE's responsibility and will be provided without charge. Other service requirements will be at the owner's expense. If you have problems in obtaining satisfactory warranty service, write or call the LGE Customer Interactive Center. Service may be provided by independently owned and operated service organizations.

To assure proper credit and avoid unnecessary charges, you must obtain an LGE Return Authorization before returning any product to the LGE Service Center. Contact the Customer Interactive Center for details.

TO CONTACT THE LGE CUSTOMER SERVICE CENTER BY MAIL:

LGE Customer Interactive Center
P.O. Box 240007
201 James Record Road
Huntsville, Alabama 35824
<http://www.lgservice.com>

P/NO : 3828VA0528N @ (3828VB0002M)