

Table of Contents

| | |
|----------------------------------------------------------------|-----|
| Safety Precautions | A1 |
| Accessories | A4 |
| Before connecting to the PC | A5 |
| Name and Function of the Parts | A7 |
| Connecting to External Devices | A13 |
| Connecting to your PC | A13 |
| Connecting to VCR/DVD | A15 |
| Connecting to DVD/SET -TOP BOX | A17 |
| When Watching TV | A18 |
| To arrange cables using cable holder | A19 |
| | |
| Adjusting the Screen | A20 |
| Name of the Buttons in the screen Adjustment Unit | A20 |
| OSD (On Screen Display) Menu | A22 |
| OSD (On Screen Display) Screen Tracking Order | A23 |
| STATION ID set/Select the channel when using the TV | A24 |
| PICTURE ID to adjust the picture function (TV/video) | A27 |
| PICTURE ID to adjust the picture function (RGB-DTV, RGB-PC) | A28 |
| SOUND ID to adjust the sound function | A29 |
| TIME ID to adjust the time function | A30 |
| SPECIAL ID to select the special function | A31 |
| SCREEN ID to adjust the screen function (RGB-PC, RGB-DTV Only) | A32 |
| | |
| Troubleshooting | A33 |
| Specifications | A36 |

Please read these safety precautions carefully before using the product.



Warning

If you ignore the warning message, you may be seriously injured or there is a possibility of accident or death.



Caution

If you ignore the caution message, you may be slightly injured or the product may be damaged



Precautions in installing the Product



Warning

- **Keep away from heat sources like electrical heaters.**
 - Electrical shock, fire, malfunction or deformation may occur.
- **Keep the packing anti-moisture material or vinyl packing out of the reach of children.**
 - Anti-moisture material is harmful if swallowed. If swallowed by mistake, force the patient to vomit and visit the nearest hospital. Additionally, vinyl packing can cause suffocation. Keep it out of the reach of children.
- **Do not put heavy objects on the product or sit upon it.**
 - If the product collapses or is dropped, you may be injured. Children must pay particular attention.
- **Do not leave the power or signal cable unattended on the pathway.**
 - The passerby can falter, which can cause electrical shock, fire, product breakdown or injury.
- **Install the product in a neat and dry place.**
 - Dust or moisture can cause electrical shock, fire or product damage.
- **If you smell smoke or other odors or hear a strange sound unplug the power cord and contact the service center.**
 - If you continue to use without taking proper measures, electrical shock or fire can occur.
- **If you dropped the product or the case is broken, turn off the product and unplug the power cord.**
 - If you continue to use without taking proper measures, electrical shock or fire can occur. Contact the service center.
- **Do not drop metallic objects such as coins, hair pins, chopsticks or wire into the product, or inflammable objects such as paper and matches. Children must pay particular attention.**
 - Electrical shock, fire or injury can occur. If a foreign object is dropped into the product, unplug the power cord and contact the service center.



Caution

- **Make sure the product ventilation hole is not blocked. Install the product in a suitably wide place (more than 10cm from the wall)**
 - If you install the product too close to the wall, it may be deformed or fire can break out due to internal heat.
- **Do not block the ventilation hole of the product by a tablecloth or curtain.**
 - The product can be deformed or fire can break out due to overheating inside the product.
- **Install the product on a flat and stable place that has no risk of dropping the product.**
 - If the product is dropped, you may be injured or the product may be broken.
- **Install the product where no EMI occurs.**
- **Keep the product away from direct sunlight.**
 - The product can be damaged.



Electrical Power Related Precautions

Warning

- **Make sure to connect the power cable to the grounded current.**
 - You may be electrocuted or injured.
- **Use the rated voltage only.**
 - The product can be damaged, or you may be electrocuted.
- **During a thunder or lightning storm, unplug the power cable or signal cable.**
 - You may be electrocuted or a fire can break out.
- **Do not connect several extension cords, electrical appliances or electrical heaters to a single outlet. Use a power bar with a grounding terminal designed for exclusive use with the computer.**
 - A fire can break out due to overheating.
- **Do not touch the power plug with wet hands. Additionally, if the cord pin is wet or covered with dust, dry the power plug completely or wipe dust off.**
 - You may be electrocuted due to excess moisture.
- **If you don't intend to use the product for a long time, unplug the power cable from the product.**
 - Covering dust can cause a fire, or insulation deterioration can cause electric leakage, electric shock or fire.
- **Fix the power cable completely.**
 - If the power cable is not fixed completely, a fire can break out.
- **Hold the plug when pulling out the power cable. Do not bend the power cord with excessive force or put heavy objects on the power cord.**
 - The power line can be damaged, which may cause electric shock or fire.
- **Do not insert a conductor (like a metal chopstick) into one end of the power cable while the other end is connected to the input terminal on the wall. Additionally, do not touch the power cable right after plugging into the wall input terminal.**
 - You may be electrocuted.
- **The power supply cord is used as the main disconnection device. Ensure that the socket-outlet is easily accessible after installation.**

Caution

- **Do not unplug the power cord while the product is in use.**
 - Electrical shock can damage the product.

Precautions in Moving the Product

Warning

- **Make sure to turn off the product.**
 - You may be electrocuted or the product can be damaged.
 - **Make sure to remove all cables before moving the product.**
 - You may be electrocuted or the product can be damaged.
- 

Caution

- Do not shock the product when moving it.
 - You may be electrocuted or the product can be damaged.
 - Do not dispose the product-packing box. Use it when you move.
 - Make the panel face forward and hold it with both hands to move.
 - If you drop the product, the damaged product can cause electric shock or fire. Contact with the service center for repair.
-

Precautions in Using the Product

Warning

- Do not disassemble, repair or modify the product at your own discretion.
 - Fire or electric shock accident can occur.
 - Contact the service center for check, calibration or repair.
- When cleaning the brown tube surface, unplug the power cord and scrub with soft cloth to prevent scratching. Do not clean with a wet cloth.
- Keep the product away from water.
 - Fire or electric shock accident can occur.

Caution

- Do not put or store inflammable substances near the product.
 - There is a danger of explosion or fire due to careless handling of the inflammable substances.
 - When cleaning the brown tube surface, unplug the power cord and scrub with soft cloth to prevent scratching. Do not clean with a wet cloth.
 - The water can sink into the product, which can cause electric shock or serious malfunction.
 - Take a rest from time to time to protect your vision.
 - Keep the product clean at all times.
 - Take a comfortable and natural position when working with a product to relax the muscles.
 - Take a regular break when working with a product for a long time.
 - Do not press strongly upon the panel with a hand or sharp object such as nail, pencil or pen, or make a scratch on it.
 - Keep the proper distance from the product.
 - Your vision may be impaired if you look at the product too closely.
 - Set the appropriate resolution and clock by referring to the User's Guide.
 - Your vision can be impaired.
 - Use authorized detergent only when cleaning the product. (Do not use benzene, thinner or alcohol.)
 - Product can be deformed.
-

On Disposal

- The fluorescent lamp used in this product contains a small amount of mercury.
- Do not dispose of this product with general household waste.
Disposal of this product must be carried out in accordance to the regulations of your local authority.



**Make sure the following items are included with your product.
The product and the accessories can be different from the figures shown below.**

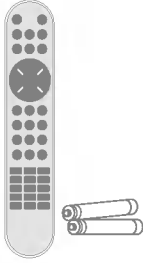

Remote Control/Batteries

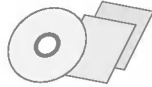

CD-ROM/Cards



D-Sub Signal Cable



Power Cord



Audio Cable (PC)



Stand base

Inserting batteries into remote control.

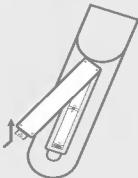

1. Take out the battery cap.
 2. Insert the batteries with correct polarity (+/-).
 3. Close the battery cap.
- You can use a remote control 7 meter distance and 30 degree (left/right) within the receiving unit scope.
 - Dispose of used batteries in the recycle bin to prevent environmental pollution.

- Before setting up the product, ensure that the power supply, the computer system, and other attached devices is turned off.

Connecting the stand base

1. Put the product with the front side facing downward on a soft cloth.
2. Align the hooks on the stand base with the matching slots in the base of the product.
3. Insert and push the hooks into slots.

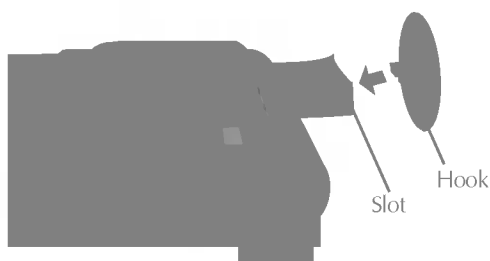

Removing the stand base

1. Put the product with the front side facing downward on a soft cloth.
2. To remove the stand base, hold the bottom of the stand with one hand and pull the base bottom latch with the other hand, as shown in the figure.

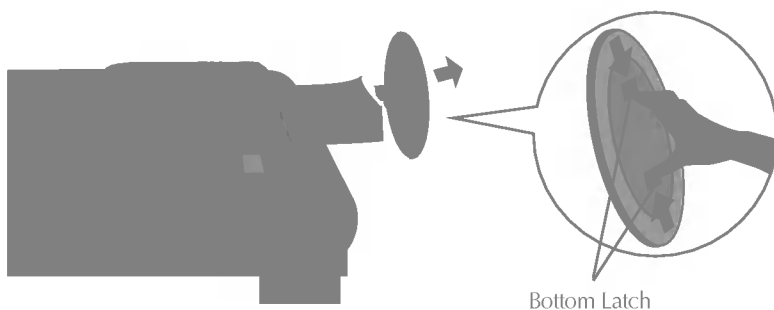

Important

- Once you connect the stand base, try not to disconnect it.
- Do not carry the product upside down holding only the stand base. The product may fall and get damaged or injure your foot.



- Before setting up the product, ensure that the power supply, the computer system, and other attached devices is turned off.

Positioning your display

1. Adjust the position of the panel in various ways for maximum comfort.

■ Tilt Range : -3° ~ 25°

■ Swivel : 345°

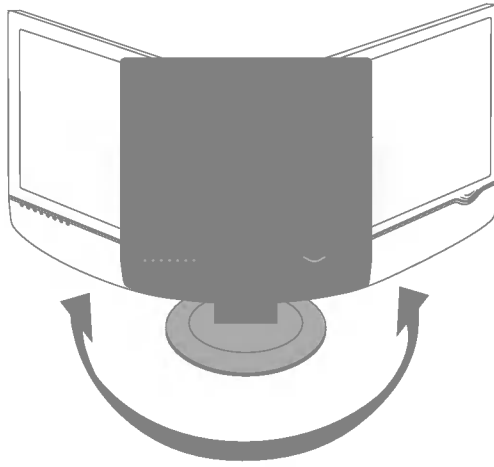
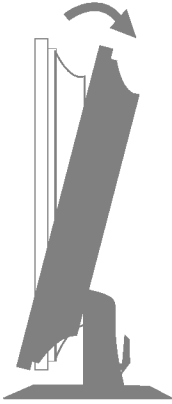

● Name of the Remote Control Buttons

Remote Control

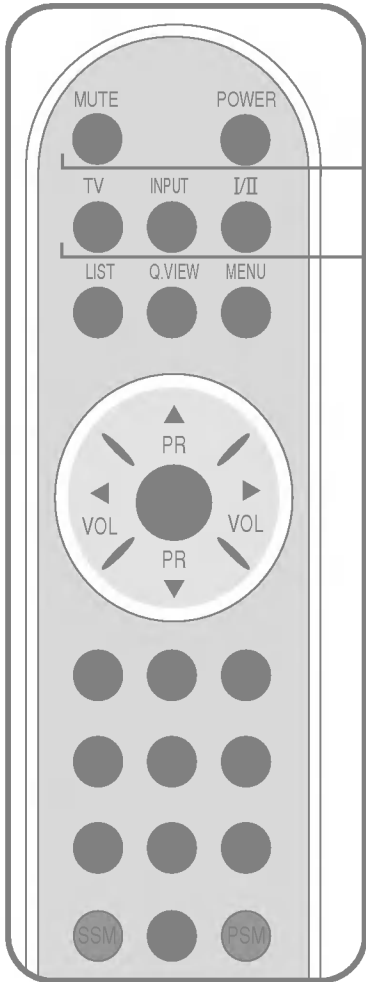

MUTE
POWER

TV : TV button

INPUT



Each time you press the INPUT button it will change to
TV → AV → RGB-DTV
→ RGB-PC.

If nothing is inputted for several seconds the screen will automatically move to the selected menu.

I/II : Bilingual choice and sound mode selection

Press this button

[TV]

- to switch from **Stereo** to **Mono** sound in case of stereo transmission, or from **Nicam Stereo** to **Nicam Mono**, in case of digital transmission.
- to switch from **Nicam Dual I** to **Nicam Dual II** or **Nicam Dual I+II** in case of Nicam Dual transmission.
- to choose between **Dual I**, **Dual II** or **Dual I+II** in case of bilingual transmission :
 - Dual I** sends the primary broadcast language to the loudspeakers ;
 - Dual II** sends the secondary broadcast language to the loudspeakers ;
 - Dual I+II** sends a separate language to each loudspeakers.

[AV]

In AV mode, you can select output sound for the left and right loudspeakers. Repeatedly press the **I/II** button to select the sound output.

- **L+R** : Audio signal from audio L input is sent to left loud-speaker and audio signal from audio R input is sent to right loud-speaker.
- **L+L** : Audio signal from audio L input is sent to left and right loud-speakers.
- **R+R** : Audio signal from audio R input is sent to left and right loud-speakers.

■ **NOTE** : In case of weak stereo sound signals, with stereo or Nicam stereo transmission, select mono reception.



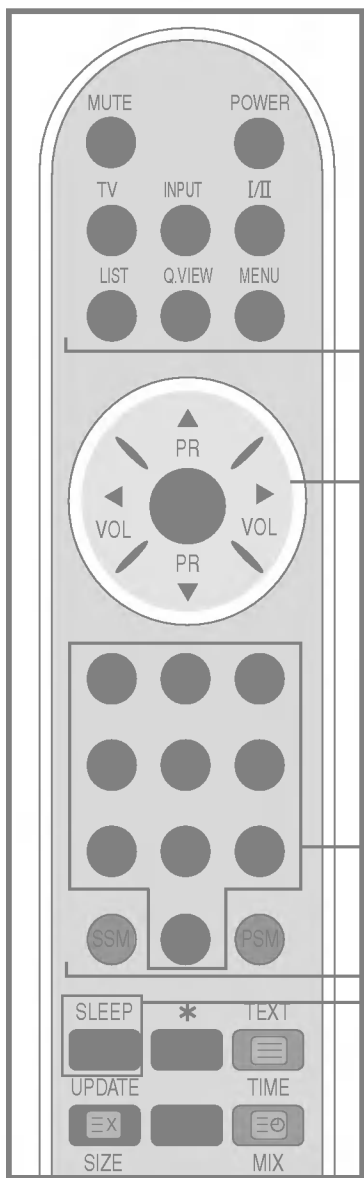

LIST : Programme list

To display the programme list (0~ 99).



Note: TV channels displayed in blue have been setup to be skipped in the Programme Edit menu.

Q.VIEW : QUICK VIEW Button

To display the previously selected TV channel

MENU

Use this button to enter the On Screen Display menu.

PR (▲ ▼) Buttons

Able to change channel.

VOL (◀ ▶) Buttons

Able to adjust sound.

OK Button

Use when functional adjustment is completed.

Number buttons

Able to directly select and change channel.

SSM (Sound Status Memory) Button

Use this button to select the sound tone.

Press repeatedly to select Flat, Music, Movie, Speech, User sound tone.

PSM (Picture Status Memory) Button

Press repeatedly to select Dynamic, Standard, Mild, Game or User picture mode.

SLEEP : SLEEP Timer

You can set a time period after which the TV / AV / S-Video should switch itself to standby. Press the key repeatedly to select the number of minutes.

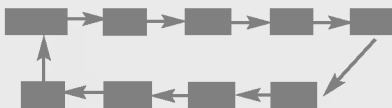

● Name of the Remote Control Buttons

Remote Control - Using the Teletext function

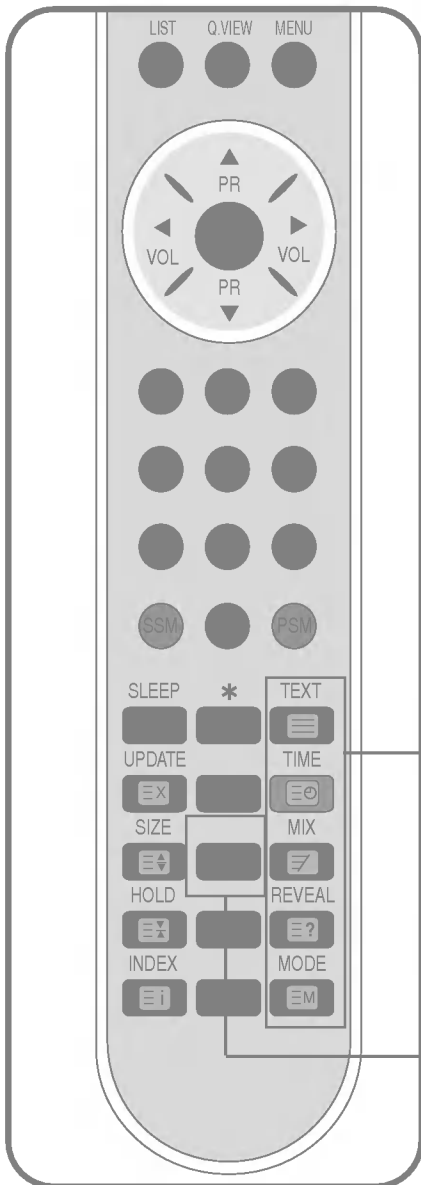

TEXT

To select the teletext on or off. The main index page or the last selected page appears on the screen together with an information headline and an option line at the bottom of the screen.

TIME

Press this button to select a sub page number. The sub page number is displayed at the bottom of the screen. To hold or change the sub page, press the RED/GREEN, ▲▼ or NUMBER buttons. Press again to exit this function.

MIX

Display the teletext pages superimposed on the TV picture. To switch the TV picture off press this button again.

REVEAL

Press the button to reveal/conceal the hidden information, such as solutions to riddles and puzzles. Press this button again to remove the information from the display.

MODE

The mode will be switched in the Teletext mode.

Yellow key

Favourite Program On : Rotate favourite channel



Remote Control - Using the Teletext function

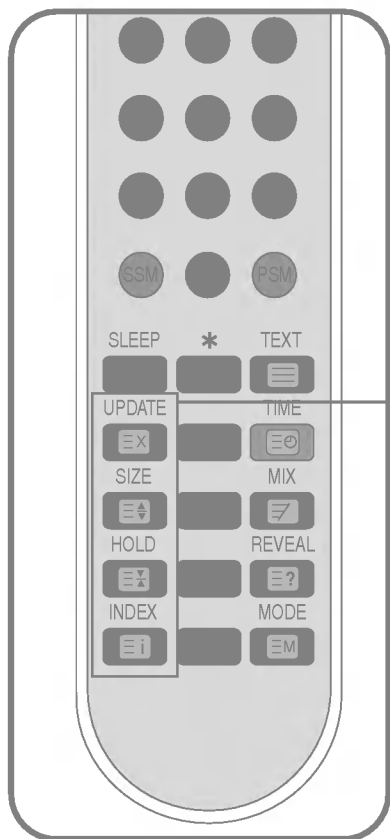

UPDATE

Press the button to appear the TV programme. At the top of screen indicates that you are still in the teletext mode. Before interrupting teletext, you may select a page number. When the page has been found, the information line appears briefly on your screen. Press the button again to reappear teletext.

SIZE

Press the button repeatedly to display the upper part, the lower part and then to return to the normal page size.

HOLD

Press the button to stop the automatically rotating of the subpages. Press the button again to continue the automatic rotating again.

INDEX

To display the main index.

● Rear View

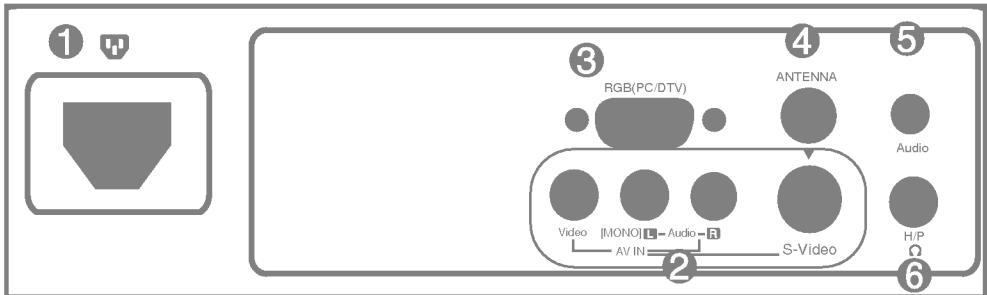
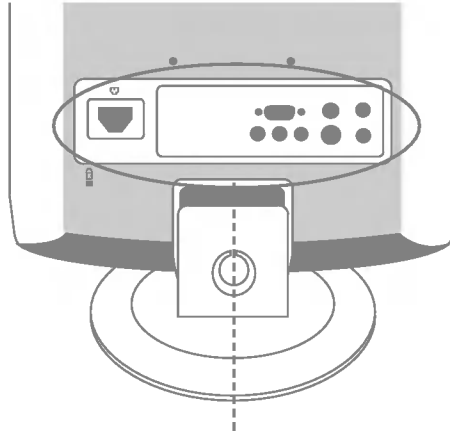

- ① Power Connector : Connect the power cord.
- ② AV Input Terminal
- ③ D-Sub Analog Signal Connector
- ④ TV Tuner Jack : Connect the antenna.
- ⑤ PC Sound Jack : Connect to the jack in the PC sound card.
- ⑥ Headphone/Earphone Connection Terminal



● AV Input Terminal

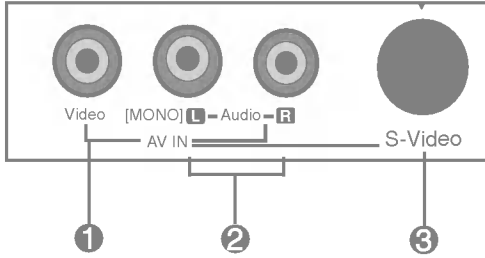

- ① **Video Input Terminal**
- ② **Audio Input Terminal**
- ③ **S-Video Input Terminal**

● Connecting the sound card output terminal

- Make sure to check the sound card connection terminal in the PC before connecting to the product.
If the PC sound card supports both Speaker Out and Line Out, change it to Line Out by setting the jumper or the PC application. (For more details, refer to the sound card user's guide.)
 - **Speaker Out** : The terminal connected to the speaker that is not equipped with an amplifier.
 - ***Line Out** : The terminal connected to the speaker equipped with an amplifier.If Audio Out in the PC sound card has only Speaker Out, reduce the PC volume. This product is integrated with an amplifier.



1. First of all, see if the computer, product and the peripherals are turned off. Then, connect the signal input cable.

When connecting with the D-Sub signal input cable.

Rear side of the product.

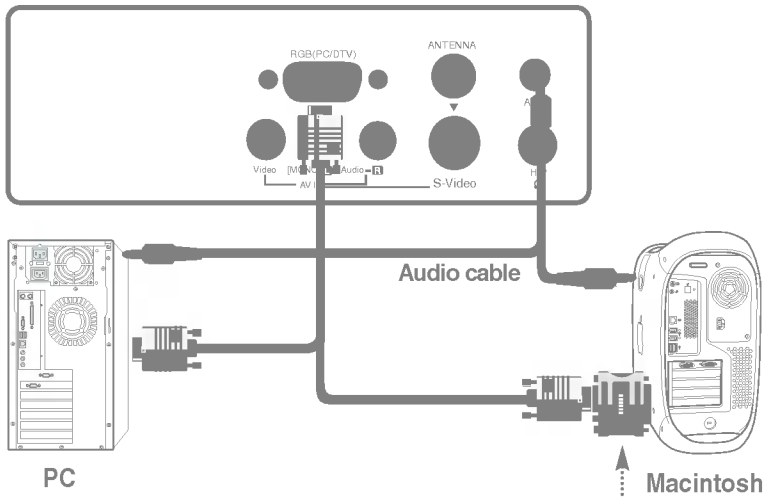
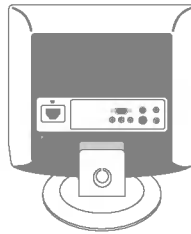

Macintosh Adapter (Not included)
Use the standard Macintosh adapter since an incompatible adapter is available in the market. (Different signaling system)



2. Connect the power cord.

Rear side of the product.

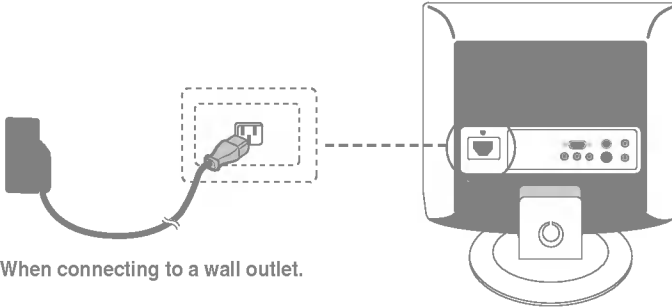

* When connecting to a wall outlet.

3. ① Turn on power by pressing the power button on the product.



Power button

② Turn on the PC.

4. Select an input signal.

Press the INPUT button on the remote control to select the input signal.

INPUT → OK

Or, press the INPUT button at the front side of the product.

INPUT → OK

- Select RGB-PC

Each time you press the Input button it will change to
TV → AV → RGB-DTV → RGB-PC.
If nothing is inputted for several seconds the screen will automatically move to the selected menu.

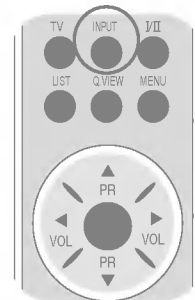

- Directly connect to a grounded power outlet on the wall or a power bar with a ground wire.

- 1** ■ Connect the video/audio cable as shown in the below figure and then connect the power cord (See page A14).

- (A)** When using the RCA cable.
- Connect the input terminal with a proper colour match.
(Video – Yellow, Sound (left) – White, Sound (right) – Red)

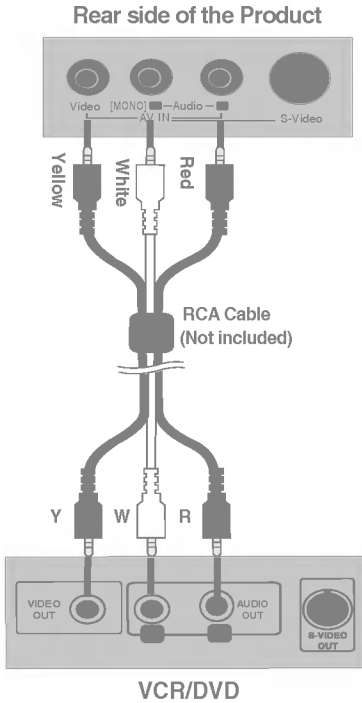

- (B)** When using the S-Video cable.
- Connect to the S-Video input terminal to watch high image quality movies.

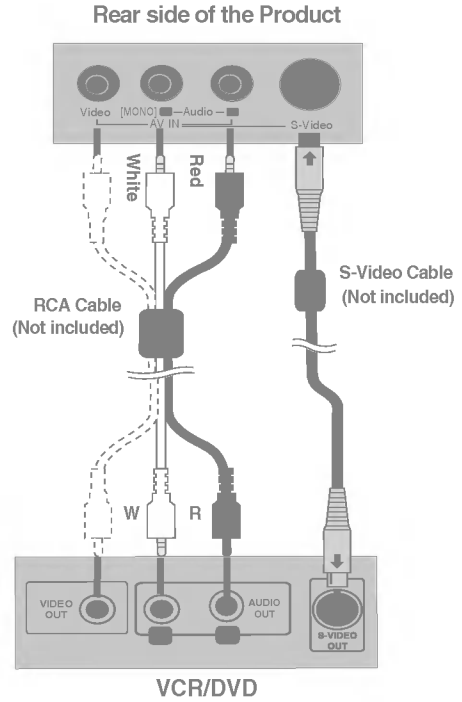

Note • In case the RCA cable is connected simultaneously as S-Video cable is connected, S-Video cable is first.

- 2.** Select an input signal.
Press the **INPUT** button on the remote control to select the input signal.

INPUT → OK

Or, press the **INPUT** button at the front side of the product.

INPUT → OK

- A** When connecting with a RCA cable.
 - Select **AV**
- B** When connecting with a S-Video cable.
 - Select **AV**

Each time you press the Input button it will change to
TV → AV → RGB-DTV → RGB-PC.
If nothing is inputted for several seconds the screen will automatically move to the selected menu.

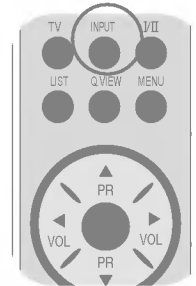

1. When connecting the viConnect the D-sub cable, RCA/PC cable as shown in the below figure and then connect the power cord. (see page A14)

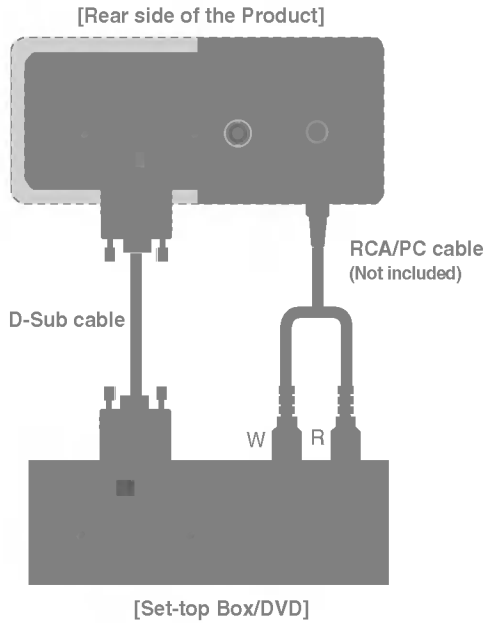

2. Select an input signal.
Press the INPUT button on the remote control to select the input signal.

INPUT → OK

Or, press the INPUT button at the front side of the product.

INPUT → OK

- Select RGB-DTV

Each time you press the Input button it will change to
TV → AV → RGB-DTV → RGB-PC.
If nothing is inputted for several seconds the screen will automatically move to the selected menu.

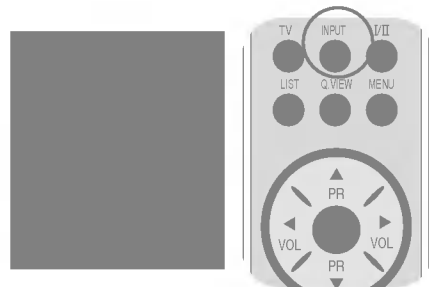

- 1.** Check if the antenna cable is connected at the rear side of the product and then, connect the power cord.

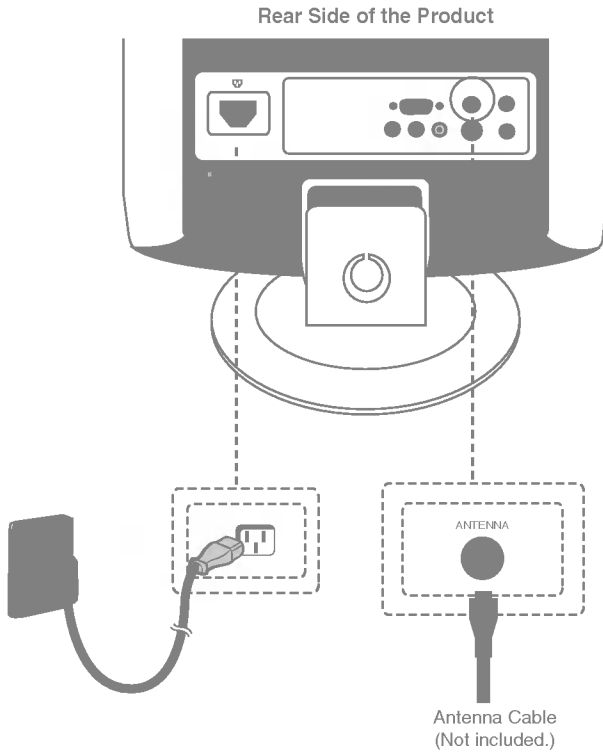

- 2.** Select an input signal.
Press the INPUT button on the remote control to select the input signal.

INPUT → OK

Or, press the INPUT button at the front side of the product.

INPUT → OK

- Select TV

Each time you press the Input button it will change to
TV → AV → RGB-DTV → RGB-PC.
If nothing is inputted for several seconds the
screen will automatically move to the
selected menu.

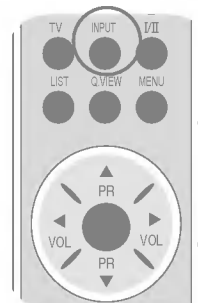

Use the cable holder to simplify the cable arrangement.

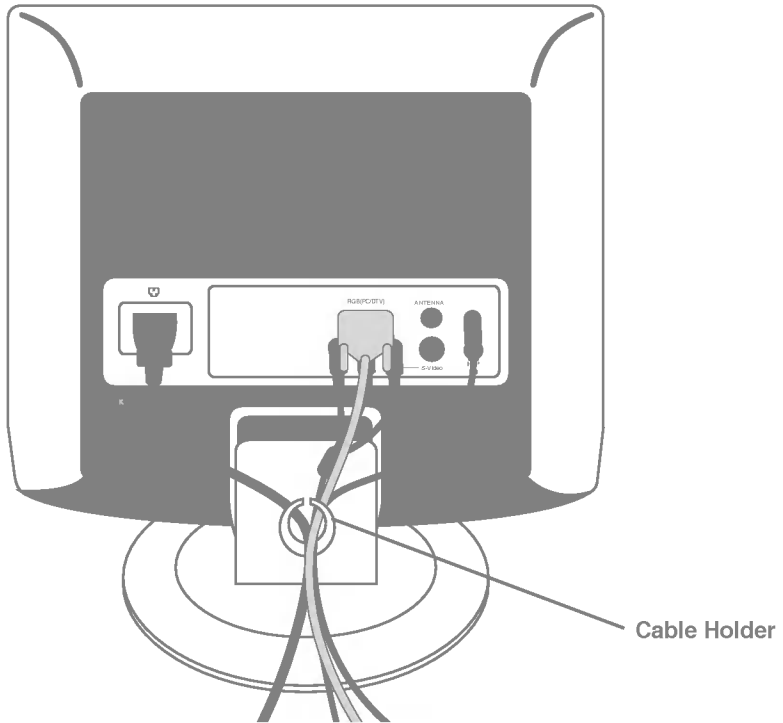

Name of the Buttons in the Screen Adjustment Unit

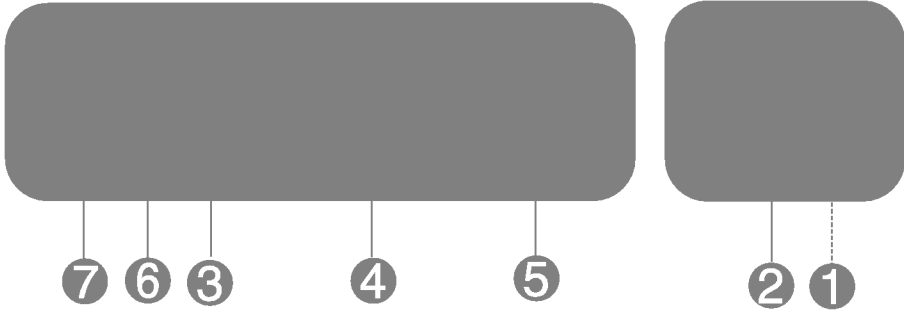

-
- 1** **Power Indicator** • This Indicator lights up blue when the display operates normally (On Mode). If the display is in Sleep (Energy Saving) Mode, this indicator colour changes to amber.
-
- 2** **Power Button** • Use this button to turn the product on and off.
-
- 3** **MENU Button** • Use this button to show/hide the OSD (On Screen Display) menu screen.
-
- 4** **OSD Select/Adjust Button** • Use this button to select an icon or adjust the setting in the OSD screen.
- ▼▲** • Use this button to control the channel for the TV signal.
-
- ◀▶** • Adjust the volume. 
-



● Name of the Buttons in the Screen Adjustment Unit

5

OK Button

- OK button is usually used in choosing the MENU. When there is no MENU on the screen pushing the OK button will give the information about the current input source.

[For PC Analog signal]



6

INPUT Button

| | |
|---------|---------------------|
| TV | Television |
| AV | CVBS, S-Video |
| RGB-DTV | DTV |
| RGB-PC | D-Sub analog signal |

Each time you press the Input button it will change to
TV → AV → RGB-DTV → RGB-PC.
If nothing is inputted for several seconds the screen will automatically move to the selected menu.

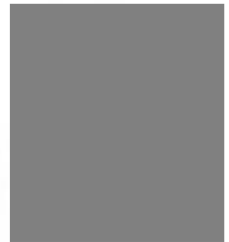







7

IR Receiver

- The unit that receives the signal from the remote control.

OSD (On Screen Display) Menu

| Icon | Function Description |
|----------------------------------------------------------------------------------------------|-------------------------------------------------------|
|  STATION | Set/Select the channel when using the TV |
|  PICTURE | Adjusting the picture function. |
|  SOUND | Adjusting the sound function. |
|  TIME | Adjusting the time function. |
|  SPECIAL | Selecting the setup function. |
|  SCREEN | Adjusting the screen function. (RGB-PC, RGB-DTV only) |



Note OSD(On Screen Display)

The OSD function enables you to adjust the screen status conveniently since it provides graphical presentation.



OSD (On Screen Display) Screen Tracking Order

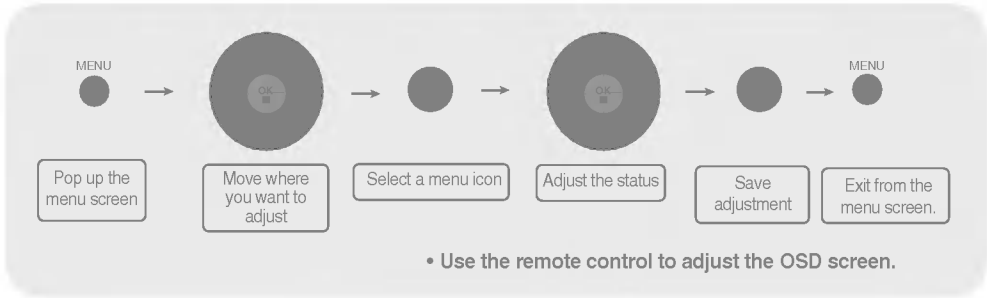

Press the **MENU** Button, then the main menu of the OSD appears.

To access a control, use the **▼▲** Buttons.

When the icon you want becomes highlighted, press the **OK** Button.

Use the **▼▲◀▶** Buttons to adjust the item to the desired level.

Accept the changes by pressing the **OK** Button.

Exit the OSD by pressing the **MENU** Button.



STATION ID set/Select the channel when using the TV

Auto programme

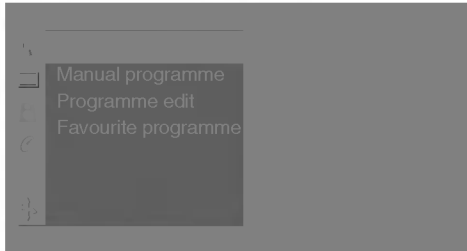

- System** It should be set before run auto searching.
Press the ▼▲ buttons to select the TV system of the country or part of the world from where you want to receive the TV channels.
* Supporting channel : C(V/UHF 01~69) S(Cable 01~47)
L : SECAM L/L (France)
BG : PAL B/G, SECAM B/G (Europe/East Europe)
I : PAL I/II (U.K/Ireland)
DK : PAL D/K, SECAM D/K (East Europe)
M : NTSC-Multi
- Storage from** To select a programme number or enter the programme number with the number buttons from where you want to start searching for new channels. If e.g. you want to keep the channels 1 to 10 stored earlier, enter programme number 11. Your TV search for new channels from number 11 onwards.
- Search** Press OK or ► button to start automatic programming. All available TV channels will be searched and stored automatically. To stop auto programming, press the MENU button. When auto programming is completed, the programme list menu appears.

Manual programme

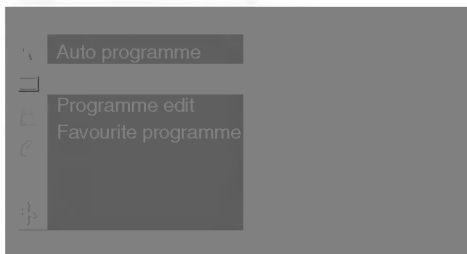

To change the channel.
(Change each item in Manual Program and press the "MENU" button to save the settings)

- Storage** Press the ◀ ▶ buttons to select the channel number or enter the programme number with the number buttons in where you want to store channel.
- System** Press the ▼▲ buttons to select the TV system of the country or part of the world from where you want to receive the TV channels.
L : SECAM L/L (France)
BG : PAL B/G, SECAM B/G (Europe/East Europe)
I : PAL I/II (U.K/Ireland)
DK : PAL D/K, SECAM D/K (East Europe)
M : NTSC-Multi



STATION ID set/Select the channel when using the TV

- Channel** Press the ▼▲ buttons to select **VHF/UHF** for aerial channels or **Cable** for cable channels. If you know the channel number, enter it directly with the digit buttons 0 to 9.
To select the channel reception type. : **VHF/UHF / Cable**
- Search** Use the ◀▶ buttons to search next channel backward or forward direction.
- Name** To see the assigned channel name.
It is possible to change the name stored in the memory or to assign a name to a TV channel which has not yet been entered. A name with up to 5 letters or numbers can be given to the programme numbers 0 to 99.
Press the ◀▶ buttons to move cursor to be changed. -> Press the ▼▲ buttons to select a character.(space, number 0~9, and alphabet A~Z, +,-) -> Press **OK** button or **MENU** button.

Programme edit

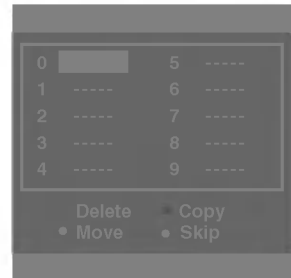
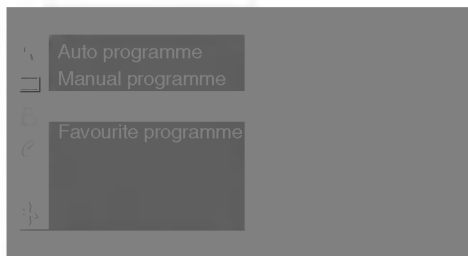

- Delete** Press the ▼▲◀▶ buttons to select a TV channel to be deleted. -> Press the red key on the remote control -> The background colour of the selected channel will change to red.
Press the Delete button one more time to delete the selected channel. All the following channels are shifted up one position.
- Copy** Press the ▼▲◀▶ buttons to select a TV channel to be copied. -> Press the green key on the remote control. All the following channel numbers are shifted down one position.
- Move** Press the ▼▲◀▶ buttons to select a channel number to be moved. -> Press the yellow key on the remote control. -> Press the ▼▲◀▶ buttons to move the TV channel to the desired channel number. -> Press the yellow key again to release this function.
- Skip** Press the ▼▲◀▶ buttons to select a channel number to be skipped. -> Press the blue key on the remote control. The skipped TV channel is displayed in blue.



STATION ID set/Select the channel when using the TV

Favourite programme

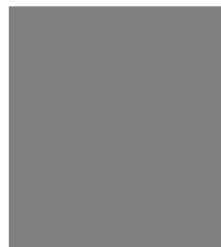

This function lets you select your favourite programmes directly. (8 channel)
Press the ▼▲◀▶ buttons to select a channel.

* **Yellow key (remote control)** : Rotate Favourite channel.





PICTURE ID adjust the picture function (TV/Video)

PSM

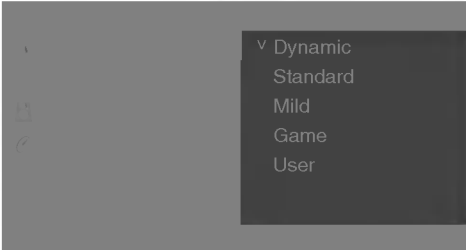

The **PSM** function automatically adjusts the screen image quality. (It is not working in PC input.)

- **Dynamic**
Select this option to display with a sharp image.
- **Standard**
The most general and natural screen display status.
- **Mild**
Select this option to display with a mild image.
- **Game**
Select this option to enjoy dynamic image when playing a game.
- **User**
Select this option to use the user-defined settings.

CSM

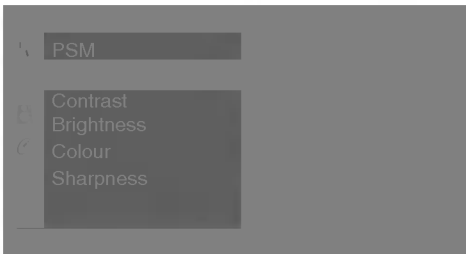

Selecting a factory setting colour set.

- **Cool**
Slightly purplish white.
- **Normal**
Slightly bluish white.
- **Warm**
Slightly reddish white.
- **User**
Select this option to use the user-defined settings.
Red / Green / Blue
Set your own colour levels.

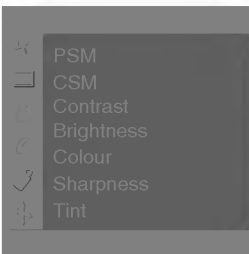

Contrast : To adjust the contrast of the screen.

Brightness : To adjust the brightness of the screen.

Colour : To adjust the colour to desired level.

Sharpness : To adjust the clearness of the screen.

Tint : To adjust the tint to desired level.

(only 60Hz signal)



PICTURE ID adjust the picture function (RGB-DTV, RGB-PC)

CSM



Selecting a factory setting colour set.

- **Cool**
Slightly purplish white.
- **Normal**
Slightly bluish white.
- **Warm**
Slightly reddish white.
- **User**
Select this option to use the user-defined settings.
Red / Green / Blue
Set your own colour levels.



Contrast : To adjust the contrast of the screen.

Brightness : To adjust the brightness of the screen.

OK MENU



SOUND ID to adjust the sound function



SSM

The best sound tone quality will be selected automatically depending on the video type that you're currently watching.

- **Flat** : The most commanding and natural audio.
- **Music** : Select this option to enjoy the original sound when listening to the music.
- **Movie** : Select this option to enjoy sublime sound.
- **Sports** : Select this option to watch sports broadcasting.
- **User** : Select this option to use the user-defined audio settings.

AVL

To adjust uneven sound volumes across all channels or signals automatically to the most appropriate level. To use this feature, select **On**.

Balance

Use this function to balance sound from the left and right speakers.





TIME ID to adjust the time function



Clock

This function is used to set up of current time.

You must set the time correctly before using **On/Off time** function.

- 1) Press the **MENU** button and then use **▼▲** button to select the **TIME** menu.
- 2) Press the **▶** button and then use **▼▲** button to select the **Clock** menu.
- 3) Press **▶** button and then use **▼▲** button to set the hour(00~23).
- 4) Press **▶** button and then use **▼▲** button to set the minutes(00~59).

The default value is -- : --.

- 5) Press the **OK/MENU** button to save.

Off/On time

The **Off time** automatically switches the set to off mode at the pre-set time.

- 1) Press the **MENU** button and then use **▼▲** button to select the **TIME** menu.
- 2) Press the **▶** button and then use **▼▲** button to select **Off time** or **On time**.
- 3) Press the **▶** button and then use **▼▲** button to set the hour(00~23).
- 4) Press the **▶** button and then use **▼▲** button to set the minutes(00~59).
- 5) Press the **▶** button and then use **▼▲** button to select **On** or **Off**.
- 6) Only **On time** function; Press the **▶** button and then **▼▲** button to adjust volume level and programme number.
- 7) Press the **OK/MENU** button to save.

Auto sleep

If **Auto sleep** is active and there is no input signal, the TV switches to off mode automatically after 10 minutes.

- 1) Press the **MENU** button and then use **▼▲** button to select the **Auto sleep** menu.
- 2) Press the **▶** button and then use **▼▲** button to select **On** or **Off**.
- 3) Press the **OK/MENU** button to save .



Note

- In the event of power interruption (disconnection or power failure), the **Clock** must be reset.
- Two hours after the set is switched on by the **On time** function it will automatically switch back to off mode unless a button has been pressed.
- Once the **On** or **Off time** is set, these functions operate daily at the preset time.
- **Off time** function overrides **On time** function if they are set to the same time.
- The set must be in off mode for the **On time** to work.
- **On timer** will move on to auto off if no activity is received in 2hours after setting the **On time**.



SPECIAL ID to Select the special function



- Language** To choose the language in which the control names are displayed.
- Input** If you press the ► button once, the following Input Signal Window will appear. Select the signal type you want using the ▼▲ button. Press OK to save the selection.
- Child lock** Use the ▼▲ buttons to select **On** or **Off**. It can be set up so that it can only be used with the remote control. This feature can prevent unauthorized viewing.
In order to lock the OSD screen adjustment, set the **Child lock** tab to the 'On' position. In order to unlock it, do the following :
Push the **MENU** button on the remote control and set **Child lock** to the 'Off' position.
- Power indicator** Use this function to set the power indicator on the front side of the product to **On** or **Off**. If you set **On** at any time, the power indicator will automatically be turned on.



SCREEN ID to adjust the screen function (RGB-PC, RGB-DTV Only)



Auto configure

This button is for the automatic adjustment of the screen **Position, Clock and Phase**.
(It is not working in RGB-DTV.)

Manual configure

This button is for the manual adjustment of the screen **Position, Clock and Phase**.

- **H-Position**
To move the display image left or right.
- **V-Position**
To move the display image up or down.
- **Clock**
To minimize any vertical bars or stripes visible on the screen background.
The horizontal screen size will also change.
- **Phase**
To adjust the focus of the display. This item allows you to remove any horizontal noise
and clear or sharpen the image of characters.

Reset

Use this function to reset the product to the factory default. However, language selection
will not be initialized.



- Is the product's power cord connected?
- Is the power indicator is turning on?
- Power is on, power indicator is blue but the screen appears extremely dark.
- Does the power indicator look amber?
- Does the 'Out of range' message appear?
- Does the 'Check signal cable' message appear?

- Check if the power cord is properly connected to the outlet.
- Check if the power switch is turned on.
- Adjust brightness and contrast again.
- If the product is in power saving mode, move the mouse or press any key.
- The signal from the PC (video card) is out of the vertical or horizontal frequency range of the product. Adjust the frequency range by referring to the Specifications in this user's guide.
 - * **Maximum resolution**
 - 17 inch : 1280 x 1024 @60Hz
 - 19 inch : 1280 x 1024 @60Hz
- The signal cable between PC and product is not connected. Check the signal cable.
- Press the 'INPUT' button in the remote control to check the input signal.

- Did you install the driver?

- Install the product driver, which is provided with the product, or download it from the web site. (<http://www.lge.com>)
- See if the plug&play function is supported by referring to the video card user's guide.



Note

* **Vertical frequency:** To enable the user to watch the product display, screen image should be changed tens of times every second like a fluorescent lamp. The vertical frequency or refresh rate is the times of image display per second. The unit is Hz.

* **Horizontal frequency:** The horizontal interval is the time to display one vertical line. When the 1 is divided by horizontal interval, the number of horizontal lines displayed every second can be tabulated as the horizontal frequency. The unit is kHz.



● **Is the screen position wrong?**

- Adjust the Position menu in OSD .
- See if the video card resolution and frequency are supported by the product. If the frequency is out of range, set to the recommended resolution in the Control Panel – Display – Setting menu.

● **Do thin lines appear on the background screen?**

- Adjust the Clock menu in OSD.

● **Horizontal noise appears or the characters look blurred.**

- Adjust the Phase menu in OSD.

● **After-image appears when the product is turned off.**

- If you use a fixed image for a long time, the pixels may be damaged quickly. Use the screensaver function.



● **No sound?**

- Check if the audio cable is connected properly.
- Adjust the volume.
- Check if the sound is set properly.

● **Sound is too low.**

- Adjust the volume.

● **The TV signal is not being received.**

- See if you have selected the proper channel mode.
- Use the automatic channel setup function.
- Check if the TV antenna is properly connected.

● **Screen has poor colour resolution (16 colours).**

- Set the colour resolution to more than 24 bits (true colour)
Select Control Panel – Display – Settings – Colour Table menu in Windows.

● **Screen colour is unstable or mono-coloured.**

- Check the connection status of the signal cable.
Or, re-insert the PC video card.

● **Do black spots appear on the screen?**

- Several pixels (red, green, white or black colour) may appear on the screen, which can be attributable to the unique characteristics of the LCD panel. It is not a malfunction of the LCD.



The product specifications can change without prior notice for product improvement.

[17 inch]

| | | |
|---------------------------------|-------------------------------|-----------------------------------------------------------------------------------------------------------------------|
| LCD Panel | Screen Type | 17 inches (43.27 cm) TFT (Thin Film Transistor) LCD (Liquid Crystal Display) Panel Visible diagonal size: 43.27 cm |
| | Pixel Pitch | 0.264 mm |
| Video Signal | Max. Resolution | 1280 X 1024 @60 Hz |
| | Recommended Resolution | 1280 X 1024 @60 Hz |
| | Horizontal Frequency | 30 - 83 kHz |
| | Vertical Frequency | 56 - 75 Hz |
| | Synchronization Type | Separate |
| Input Connector | | S-Video, Composite video, TV, D-Sub Analog, Headphone, PC Audio In |
| Power | Rated Voltage | AC 100-240V~ 50/60Hz 1.0A |
| | Power Consumption | On Mode : 40 W Sleep Mode ≤ 1 W Off Mode ≤ 1 W |
| Tilt | Tilt Range | -3° ~ 25° |
| | Swivel | 345° |
| Dimension/Weight | Size (WxLxH) | 389.5 mm x 232 mmx 437.9 mm |
| | Weight (excl. package) | 5.28 kg (12.9 lbs) |
| Environmental Conditions | Operational Condition | Temperature: 10°C ~ 35°C , Humidity: 20% ~ 80% |
| | Storage Condition | Temperature: -10°C ~ 60°C , Humidity: 5% ~ 90% |



The product specifications can change without prior notice for product improvement.

[19 inch]

| | | |
|---------------------------------|-------------------------------|-----------------------------------------------------------------------------------------------------------------------|
| LCD Panel | Screen Type | 19 inches (48.19 cm) TFT (Thin Film Transistor) LCD (Liquid Crystal Display) Panel Visible diagonal size: 48.19 cm |
| | Pixel Pitch | 0.294 mm |
| Video Signal | Max. Resolution | 1280 X 1024 @60 Hz |
| | Recommended Resolution | 1280 X 1024 @60 Hz |
| | Horizontal Frequency | 30 - 83 kHz |
| | Vertical Frequency | 56 - 75 Hz |
| | Synchronization Type | Separate |
| Input Connector | | S-Video, Composite video, TV, D-Sub Analog, Headphone, PC Audio In |
| Power | Rated Voltage | AC 100-240V~ 50/60Hz 1.0A |
| | Power Consumption | On Mode : 45 W Sleep Mode ≤ 1 W Off Mode ≤ 1 W |
| Tilt | Tilt Range | -3° ~ 25° |
| | Swivel | 345° |
| Dimension/Weight | Size (WxLxH) | 443.6 mm x 232.0 mm x 475.6 mm |
| | Weight (excl. package) | 6 kg (13.23 lbs) |
| Environmental Conditions | Operational Condition | Temperature: 10°C ~ 35°C , Humidity: 20% ~ 80% |
| | Storage Condition | Temperature: -10°C ~ 60°C , Humidity: 5% ~ 90% |



● PC Mode – Preset Mode

[17 inch] [19 inch]

| | | | | | | | | |
|---|------|-----------|--------|----|----|-----------------|--------|----|
| 1 | VGA | 640 x 350 | 31.469 | 70 | 8 | VESA 1024 x 768 | 48.363 | 60 |
| 2 | VGA | 720 x 400 | 31.468 | 70 | 9 | VESA 1024 x 768 | 60.123 | 75 |
| 3 | VGA | 640 x 480 | 31.469 | 59 | 10 | MAC 1152 x 870 | 68.681 | 75 |
| 4 | VESA | 640 x 480 | 37.500 | 75 | 11 | VESA 1152 x 900 | 61.805 | 65 |
| 5 | VESA | 800 x 600 | 37.879 | 60 | 12 | VESA1280 x 1024 | 63.981 | 60 |
| 6 | VESA | 800 x 600 | 46.875 | 75 | | | | |
| 7 | MAC | 832 x 624 | 49.725 | 74 | | | | |

● Power Indicator

| | |
|------------|-------|
| On Mode | Blue |
| Sleep Mode | Amber |
| Off Mode | Off |

● Theft prevention locking device

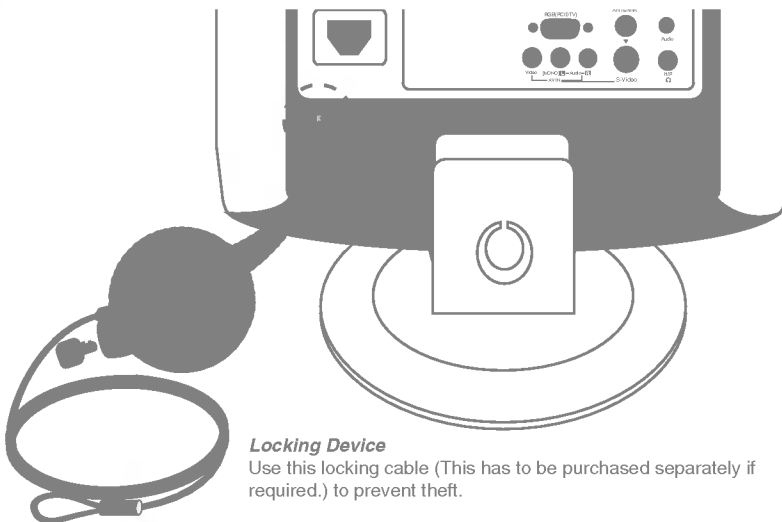

• VESA wall mounting

This product meets VESA-compliant mounting interface pad specifications.

1. Separate the **Hinge Cover** using a screwdriver as shown in the picture.

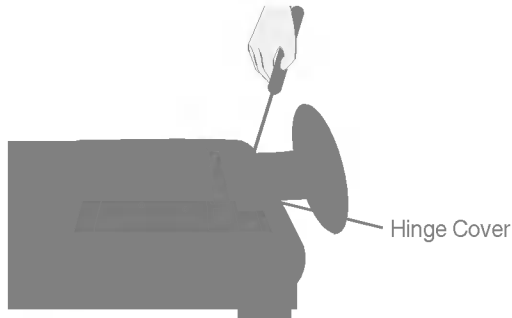

2. Put the product on a piece of cloth or other soft surface with the front side facing downward.
3. Separate the stand base using a screwdriver as shown in the picture.

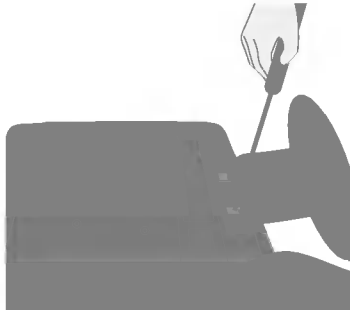

4. Install the VESA standrad wall mounting.

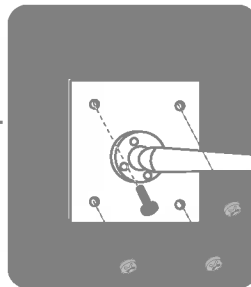
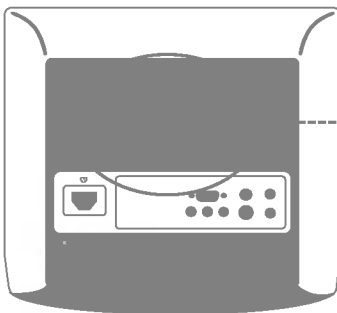

VESA wall mounting

Connected to another object (stand type and wall-mounted type). This product accepts a VESA-compliant mounting interfacepad. (This has to be purchased separately if required.)

For further information, refer to the VESA Wall Mounting Instruction Guide.

