



WIRELESS DVD RECEIVER SYSTEM

MODEL: LH-W3600SE

(Main Unit: LH-W3600

Speakers: LHS-36SES, LHS-36SEW
ACC36R, ACC36T)



USB



**MP3
CD-R/RW**

Before connecting up, operating or repairing this product,
please read this instruction booklet carefully and
completely.



CAUTION: TO REDUCE THE RISK OF ELECTRIC SHOCK DO NOT REMOVE COVER (OR BACK) NO USER-SERVICEABLE PARTS INSIDE REFER SERVICING TO QUALIFIED SERVICE PERSONNEL.



This lightning flash with arrowhead symbol within an equilateral triangle is intended to alert the user to the presence of uninsulated dangerous voltage within the product's enclosure that may be of sufficient magnitude to constitute a risk of electric shock to persons.



The exclamation point within an equilateral triangle is intended to alert the user to the presence of important operating and maintenance (servicing) instructions in the literature accompanying the product.

WARNING: TO PREVENT FIRE OR ELECTRIC SHOCK HAZARD, DO NOT EXPOSE THIS PRODUCT TO RAIN OR MOISTURE.

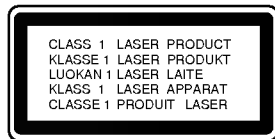

CAUTION: VISIBLE AND INVISIBLE LASER RADIATION WHEN OPEN AND INTERLOCKS DEFEATED.

CAUTION:

This product employs a Laser System.

To ensure proper use of this product, please read this owner's manual carefully and retain it for future reference. Should the unit require maintenance, contact an authorized service center.

Use of controls, adjustments or the performance of procedures other than those specified herein may result in hazardous radiation exposure.

To prevent direct exposure to laser beam, do not try to open the enclosure. Visible laser radiation when open. DO NOT STARE INTO BEAM.

CAUTION: The apparatus should not be exposed to water (dripping or splashing) and no objects filled with liquids, such as vases, should be placed on the apparatus.

CAUTION concerning the Power Cord

Most appliances recommend they be placed upon a dedicated circuit;

That is, a single outlet circuit which powers only that appliance and has no additional outlets or branch circuits. Check the specification page of this owner's manual to be certain.

Do not overload wall outlets. Overloaded wall outlets, loose or damaged wall outlets, extension cords, frayed power cords, or damaged or cracked wire insulation are dangerous. Any of these conditions could result in electric shock or fire. Periodically examine the cord of your appliance, and if its appearance indicates damage or deterioration, unplug it, discontinue use of the appliance, and have the cord replaced with an exact replacement part by an authorized servicer.

Protect the power cord from physical or mechanical abuse, such as being twisted, kinked, pinched, closed in a door, or walked upon. Pay particular attention to plugs, wall outlets, and the point where the cord exits the appliance.

To disconnect power from the mains, pull out the mains cord plug. When installing the product, ensure that the plug is easily accessible.



This product is manufactured to comply with the radio interference requirements of EEC DIRECTIVE 89/336/EEC, 93/68/EEC and 73/23/EEC.

| | |
|---|-------|
| Introduction | |
| Maintenance and Service | 3 |
| Before use | 4 |
| Front Panel/Rear Panel | 5 |
| Remote Control | 6 |
| | |
| Installation and Setup | |
| TV Connections | 7 |
| Optional Equipment Connections | 8 |
| Aerial Connections | 8 |
| Speaker System Connection | 9 |
| Setup the Wireless System | 10-11 |
| Displaying Disc Information on-screen | 12 |
| Initial Settings | 12 |
| General Operation | 12 |
| Language | 12 |
| Display | 13 |
| Audio | 14 |
| 5.1 Speaker Setup | 14 |
| Lock (Parental Control) | 15 |
| Others | 15 |
| | |
| Operation | |
| General features | 16 |
| Additional features | 17 |
| Playing an Audio CD or MP3/WMA file | 18 |
| Programmed Playback | 18 |
| Viewing a JPEG file | 19 |
| Playing a DivX Movie file | 20 |
| Presetting the Radio Stations | 21 |
| Listening to the Radio | 21 |
| RDS Operation | 22 |
| Sleep Timer Setting | 23 |
| Dimmer | 23 |
| Mute | 23 |
| Using Headphone Jack | 23 |
| Selecting input source | 23 |
| XTS/XTS pro | 23 |
| VIRTUAL sound | 23 |
| Sound Mode | 23 |
| | |
| REFERENCE | |
| Language Codes | 24 |
| Area Codes | 24 |
| Troubleshooting | 25-26 |
| Specifications | 27 |

Maintenance and Service

Refer to the information in this chapter before contacting a service technician.

HANDLING THE UNIT

When shipping the unit

Please save the original shipping carton and packing materials. If you need to ship the unit, for maximum protection, re-pack the unit as it was originally packed at the factory.

Keeping the exterior surfaces clean

- Do not use volatile liquids such as insecticide spray near the unit.
- Do not leave rubber or plastic products in contact with the unit for a long period of time. since they leave marks on the surface.

Cleaning the unit

To clean the player, use a soft, dry cloth. If the surfaces are extremely dirty, use a soft cloth lightly moistened with a mild detergent solution.

Do not use strong solvents such as alcohol, benzene, or thinner, as these might damage the surface of the unit.

Maintaining the Unit

The DVD/CD Receiver is a high-tech, precision device. If the optical pick-up lens and disc drive parts are dirty or worn, the picture quality could be diminished.

Depending on the operating environment, regular inspection and maintenance are recommended after every 1,000 hours of use.

For details, please contact your nearest authorized service center.



Translated Statements of Compliance.

This product follows the provisions of the European Directive 1999/5/EC.

Introduction

Before use

To ensure proper use of this product, please read this owner's manual carefully and retain for future reference.

This manual provides information on the operation and maintenance of your DVD/CD Receiver. Should the unit require service, contact an authorized service location.

About the Symbol Display

" " may appear on your TV display during operation and indicates that the function explained in this owner's manual is not available on that specific DVD video disc.

Symbol Used in this Manual







Note:

Indicates special notes and operating features.

Tip:

Indicates tips and hints for making the task easier.



A section whose title has one of the following symbols is applicable only to the disc represented by the symbol.

| | |
|---|----------------------------|
|  | DVD and finalized DVD±R/RW |
|  | Video CDs |
|  | Audio CDs |
|  | MP3 Discs |
|  | WMA Discs |
|  | JPEG Discs |
|  | DivX Discs |

Manufactured under license from Dolby Laboratories. "Dolby", "Pro Logic", and the double-D symbol are trademarks of Dolby Laboratories. Confidential Unpublished works. Copyright 1992-1997 Dolby Laboratories. All rights reserved.

Manufactured under license from Digital Theater Systems, Inc. U.S. Pat. No's. 5,451,942; 5,956,674; 5,974,380; 5,978,762; 6,226,616; 6,487,535 and other U.S. and world-wide patents issued and pending. "DTS" and "DTS Digital Surround" are registered trademarks of Digital Theater Systems, Inc. Copyright 1996, 2003 Digital Theater Systems, Inc. All Rights Reserved."

Types of Playable Discs

| | |
|--|---------------------------------------|
|  | DVD (8 cm / 12 cm disc) |
|  | Video CD (VCD) (8 cm / 12 cm disc) |
|  | Audio CD (8 cm / 12 cm disc) |

In addition, this unit can play a DVD-RW, DVD+RW, SVCD and CD-R or CD-RW that contains audio titles, MP3, WMA, JPEG or DivX files.

Notes:

- Depending on the conditions of the recording equipment or the CD-R/RW (or DVD-RW, DVD+RW) disc itself, some CD-R/RW (or DVD-RW, DVD+RW) discs cannot be played on the unit.
- Do not attach any seal or label to either side (the labeled side or the recorded side) of a disc.
- Do not use irregularly shaped CDs (e.g., heart-shaped or octagonal). It may result in malfunctions.

Regional Code

This unit has a regional code printed on the rear of the unit. This unit can play only DVD discs labelled same as the rear of the unit or "ALL".

Notes on Regional Codes

- Most DVD discs have a globe with one or more numbers in it clearly visible on the cover. This number must match your DVD player's regional code or the disc cannot play.
- If you try to play a DVD with a different regional code from your player, the message "Check Regional Code" appears on the TV screen.

Front Panel/Rear Panel

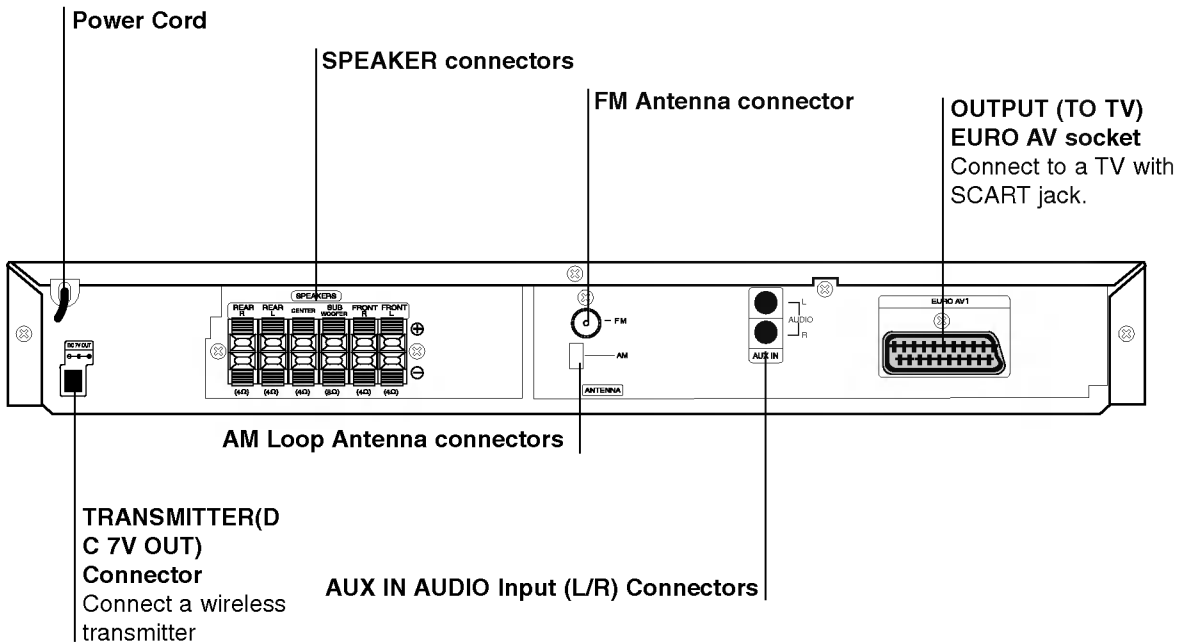
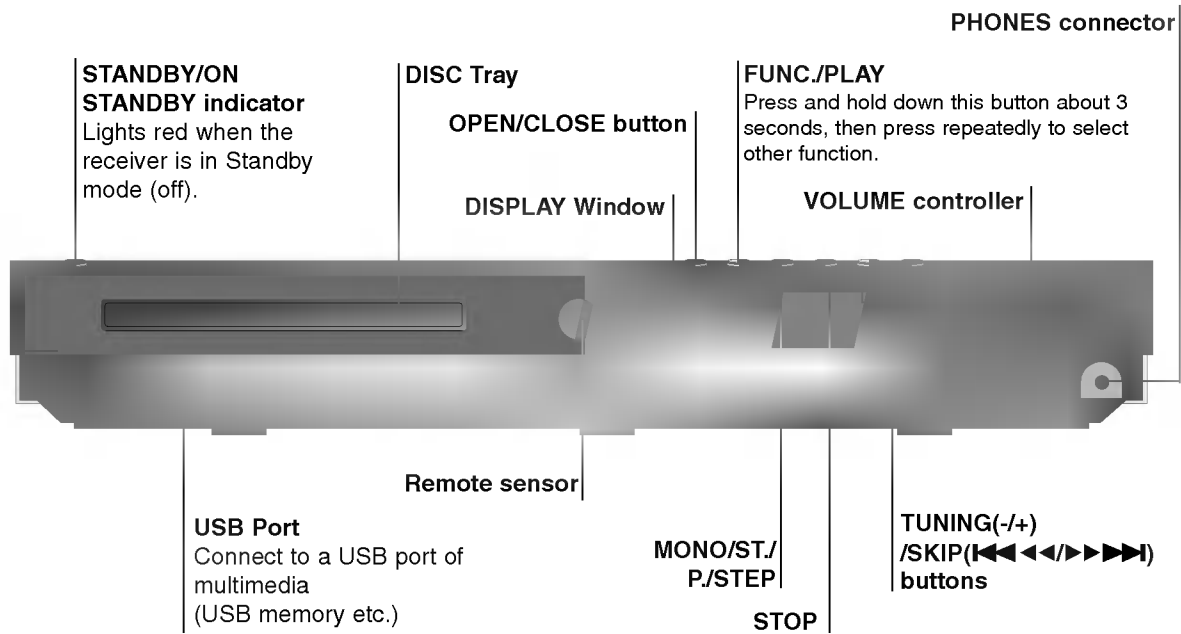

Do not touch the inner pins of the jacks on the rear panel. Electrostatic discharge may cause permanent damage to the unit.

Remote Control

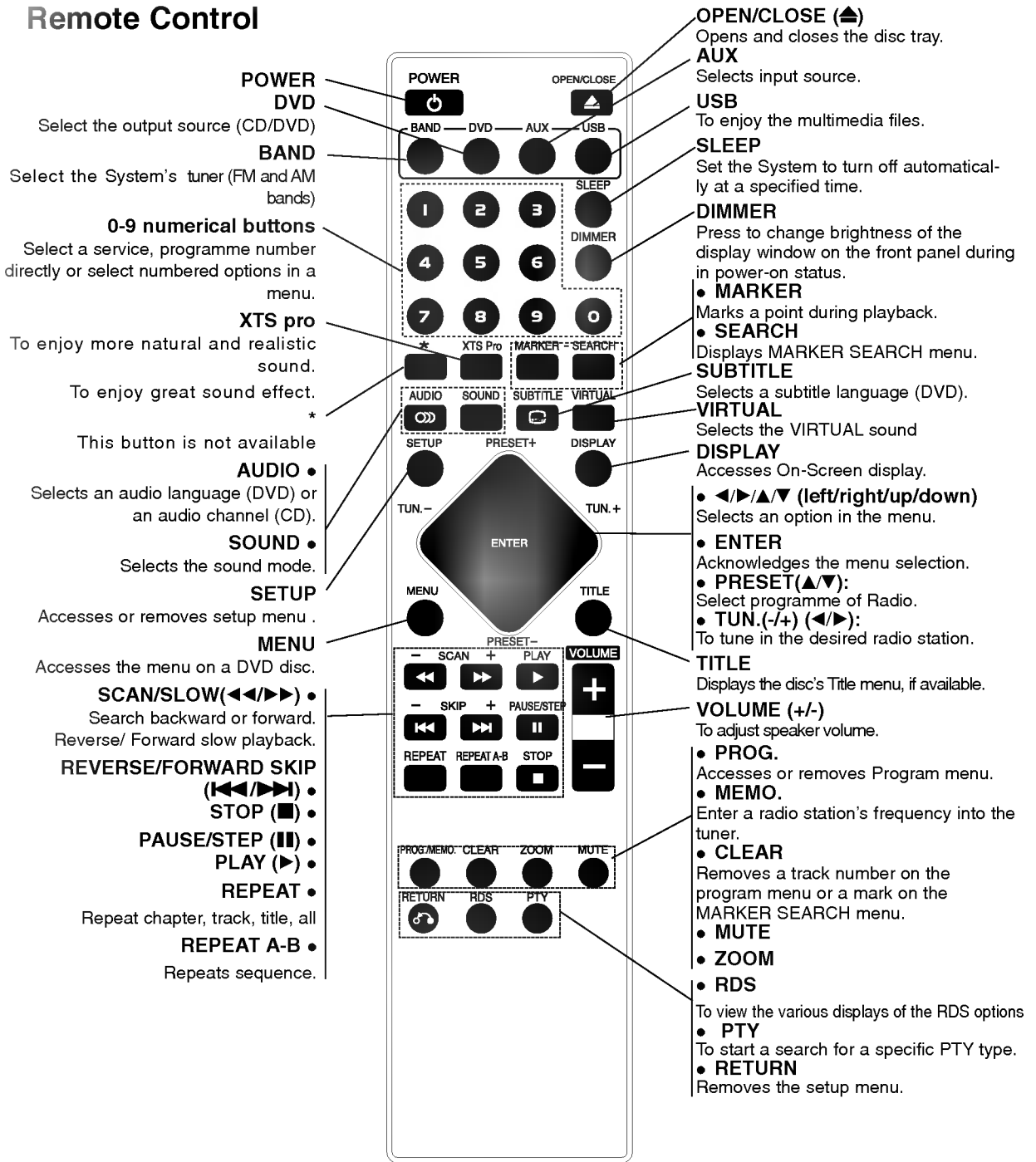

Remote Control Operation Range

Point the remote control at the remote sensor and press the buttons.

- **Distance:** About 23 ft (7 m) from the front of the remote sensor
- **Angle:** About 30° in each direction in front of the remote sensor

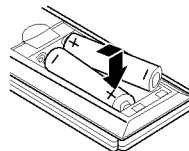

Remote control battery installation

Remove the battery cover on the rear of the remote control, and insert two R03 (size AAA) batteries with + and - aligned correctly.

Caution

Do not mix old and new batteries. Never mix different types of batteries (standard, alkaline, etc.).

Installation and Setup

TV Connections

Make one of the following connections, depending on the capabilities of your existing equipment.

Tips:

- Depending on your TV and other equipment you wish to connect, there are various ways you could connect the DVD/CD Receiver. Use one of the connections described below.
- Please refer to the manuals of your TV, VCR, Stereo System or other devices as necessary to make the best connections.

Caution:

- Make sure the DVD/CD Receiver is connected directly to the TV. Select the correct AV input on your TV.
- Do not connect your DVD/CD Receiver to TV via your VCR. The DVD image could be distorted by the copy protection system.

SCART connection

Connect the EURO AV OUTPUT (TO TV) socket on the DVD/CD Receiver to the corresponding in jacks on the TV using the scart cable (T).

- If your television is a high-definition or "digital ready" television, you may take advantage of the DVD/CD Receiver's progressive scan output for the highest video resolution possible.
- If your TV does not accept your resolution setting, abnormal picture appears on the screen. Please read TV's owner's manual then set the resolution that your TV can accept.

Note:

A picture via scart input is not supported.

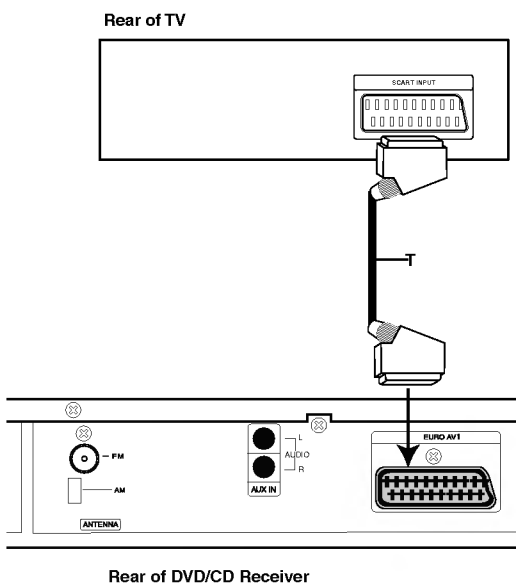

Optional Equipment Connections

1. Connect a VCR to the AUX IN connectors.
2. Connect the USB port of a USB Memory (or MP3 player, etc.) to the USB port on the front of the unit.

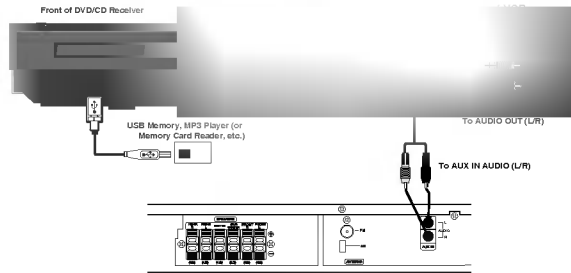

To Remove the USB Device from the unit

1. Choose a different function mode or press the STOP (■) twice in a row.
2. Remove the USB device from the unit.

Notes:

- Don't extract the USB device while operating.
- Music files (MP3/WMA), image files (JPEG) and DivX files can be played.
- This unit can not use a USB HUB.
- Recommended Memory Cards.
Compact Flash Card (CFC), Micro Drive (MD), Smart Media Card (SMC), Memory Stick (MS), Secure Digital Card (SD), Multi Media Card (MMC), Memory Stick Pro (MS-Pro)
- Compatible with : FAT16, FAT32
- Only use the memory cards recommended.
- Devices which require additional program installation when you have connected the unit to a computer are not supported.
- In case of a USB HDD, make sure to connect an auxiliary power cord to the USB HDD for proper operation. Up to four primary partitions of a drive are supported. If there is an extension partition, it will not be supported.
- If the drive of USB device is two or more, a drive folder is displayed on the screen. If you want to move to the initial menu after you select a folder, press RETURN.
- Digital cameras and mobile phones are not supported.

Antenna Connections

Connect the supplied FM/AM antenna for listening to the radio.

- Connect the AM Loop antenna to the AM antenna connector.
- Connect the FM Wire antenna to the FM antenna connector.

Notes:

- To prevent noise pickup, keep the AM Loop antenna away from the DVD/CD Receiver and other components.
- Be sure to fully extend the FM wire antenna.
- After connecting the FM Wire antenna, keep it as horizontal as possible.

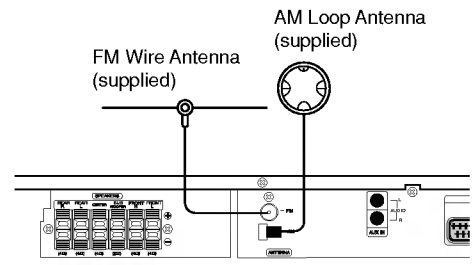

Speaker System Connection

- Connect the speakers to the front (right, left) or center speaker connectors at the main set.
- Connect the subwoofer to the woofer connector.
- Connect the power cord of the Wireless RX to the outlet, then connect the Wireless RX and the rear speaker (right, left) with the speaker cable.
- Connect the DC IN connector of the Wireless TX and the Wireless TX (DC 7V OUT) connector of the main set with the DC power cable.
- Connect the SOUND SIGNAL connector of the Wireless TX and rear (right, left) speaker of connectors of the main set with the sound signal cable.
- Set the distance between Wireless TX and Wireless RX within 10m.

Notes:

- Optimum performance can be implemented only when the Wireless TX and the Wireless RX within distance of 2m to 10m is used since communication failure may occur if longer distance is used.
- Be sure to match the speaker cable to the appropriate terminal on the components: + to + and - to -. If the cables are reversed, the sound will be distorted and will lack base.
- It takes about a few seconds (and may take longer) for the Wireless TX and Wireless RX to communicate with each other.
- When the unit is turned off, the Wireless RX is in standby mode (off) automatically after about 10 seconds.
- If the Wireless RX is turned off, the wireless speaker will not function.

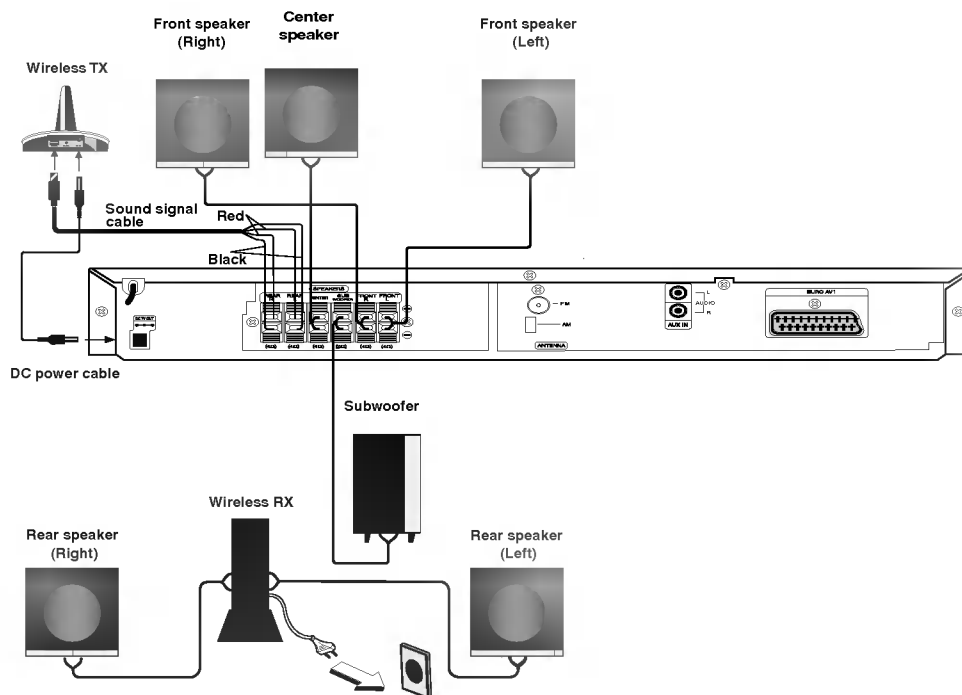

About Ferrite Core

Be sure to attach the ferrite core to the speaker cables (for connecting to this unit). This ferrite core can reduce noises.

How to attach the ferrite core

- 1 Press the stopper [a] of the ferrite core to open.
- 2 Wind the cable once on the ferrite core.
- 3 Close the ferrite core until it clicks.

Note:

Attach the ferrite core near the unit (Refer to the fig.3 and comment.).

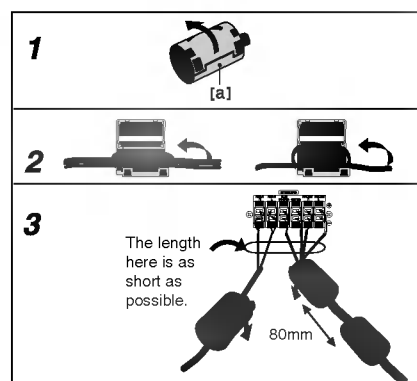

Setup the Wireless System

Note:

If there is a product with a strong electromagnetic field nearby, interference may occur.
(Ex : Micro wave oven)

Wireless TX

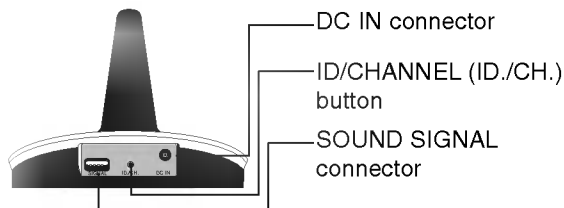

LED indicator of Wireless TX

- * LED indicator - "BLUE"
The main set is turned on, everything is connected and transmitting.
- * LED indicator - "RED"
The Wireless TX is in standby mode.
- * LED indicator - "OFF (No display)"
The main set is turned off.

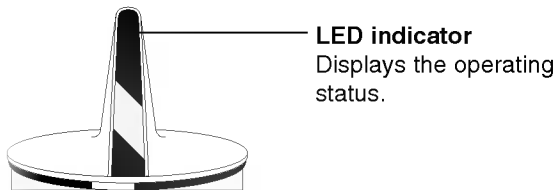

Wireless RX

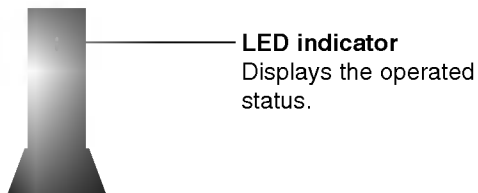

LED indicator of Wireless RX

- * LED indicator - "BLUE"
The Wireless RX is receiving a signal of Wireless TX.
- * LED indicator - "RED"
The Wireless RX is in standby mode.

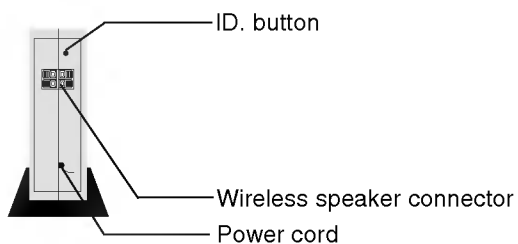

Note:

If there is no audio signal for longer than 5 minutes, Wireless TX and Wireless RX will automatically switch to a standby mode. In standby mode, both LEDs will turn red. LEDs will turn blue when an audio signal returns.

If you operate main unit then wireless speakers (rear speakers) sound within a few seconds in standby mode.

Changing a channel of Wireless TX and Wireless RX

If there is a similar wireless product nearby, interference may occur. In this case, change to another channel using ID/CHANNEL (ID./CH.) button of Wireless TX.

Manual setting

- Press ID/CHANNEL (ID./CH.) button for less than about 3 seconds.

If the wireless TX and wireless RX signals do not match after operating as above, operate it again about three times.

Auto setting

- 1 Disconnect the DC power cable from the Wireless TX.
- 2 Connect the DC power cable from the Wireless TX while you pressing the ID/CHANNEL (ID.CH.) button of Wireless TX.
 - The blue LED indicator will flicker.
- 3 Disconnect the DC power cable from the Wireless TX and release the ID/CHANNEL (ID.CH.) button of Wireless TX.
- 4 Connect the DC power cable from the Wireless TX.
 - The ID setting becomes optimization automatically .

Note:

The wireless TX may not receive the changed channel of wireless RX (The LED of Wireless TX will turn blue. The LED of Wireless RX will turn red). In this case set the ID as next paragraph.

Setting an ID of Wireless TX and Wireless RX

When the unit is manufactured, the ID is already set. If an interference occurs or you use a new Wireless RX, an ID is set again.

1. Set the wireless TX and wireless RX within 50cm of each other.
2. Turn the Wireless TX and Wireless RX on.
3. Press the ID/CHANNEL (ID./CH.) button of Wireless TX and ID button of Wireless RX at the same time for more than about 3 seconds.
 - The blue LED indicator of wireless TX and Wireless RX will flicker.
4. Release the ID/CHANNEL (ID./CH.) button of Wireless TX and ID button of Wireless RX.
 - ID is set up.

Notes:

- If there is a product with a strong electromagnetic field nearby, interference may occur.
- Do not operate a portable transmitter (such as a wireless network device) near this product.

CAUTION

Rear speaker (wireless speakers) is no sound.

- The DC power cable is not connected the Wireless TX and main unit.
Connect the Wireless TX and main unit with the DC power cable.
- Power cord of wireless RX (or wireless speakers) is not connected.
Connect the Power cord of wireless RX (or wireless speakers).
- LED indicator of Wireless TX is RED.
 - Turn on the main unit.
 - Set to sound mode by PL II MOVIE, PL II MUSIC or PL II MTRX. (page 23)
 - Set to XTS-ON. (page 23)
 - Insert a 5.1 ch sound compatible disc.

Sound is cut off.

Change a channel of Wireless TX. (Follow steps "Changing a channel of Wireless TX and Wireless RX")

- ★ If rear speaker (wireless speakers) is no sound after operating as above, disconnect and connect the power cord of Wireless RX (or wireless speakers) or set up an ID of wireless TX and wireless RX (or wireless speakers).

Displaying Disc Information on-screen

You can display various information about the disc loaded on-screen.

1. Press DISPLAY to show various playback information.
The items displayed differ depending on the disc type or playing status.
2. You can select an item by pressing ▲ / ▼ and change or select the setting by pressing ◀ / ▶.
 - Title (Track) – Current title (or track) number/total number of titles (or tracks).
 - Chapter – Current chapter number/total number of chapters.
 - Time – Elapsed playing time.
 - Audio – Selected audio language or channel.
 - Subtitle – Selected subtitle.
 - Angle – Selected angle/total number of angles.
 - Sound – Selected sound mode.

Note:

If no button is pressed for a few seconds, the on-screen display disappears.

Initial Settings

By using the Setup menu, you can make various adjustments to items such as picture and sound. You can also set a language for the subtitles and the Setup menu, among other things. For details on each Setup menu item, see pages 12 to 15.

To display and exit the Menu:

Press SETUP to display the menu. A second press of SETUP will take you back to initial screen.

To go to the next level:

Press ▶ on the remote control.

To go back to the previous level:

Press ◀ on the remote control.

GENERAL OPERATION

1. Press SETUP. The Setup menu appears.
2. Use ▲ / ▼ to select the desired option then press ▶ to move to the second level. The screen shows the current setting for the selected item, as well as alternate setting(s).
3. Use ▲ / ▼ to select the second desired option then press ▶ to move to the third level.
4. Use ▲ / ▼ to select the desired setting then press ENTER to confirm your selection. Some items require additional steps.
5. Press SETUP or PLAY to exit the Setup menu.

LANGUAGE

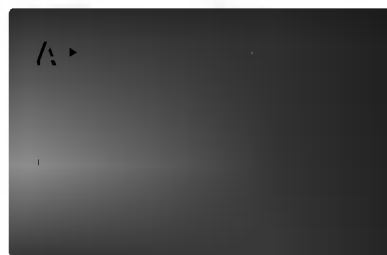

OSD

Select a language for the Setup menu and on-screen display.

Disc Audio / Subtitle / Menu

Select the language you prefer for the audio track (disc audio), subtitles, and the disc menu.

Original – Refers to the original language in which the disc was recorded.

Other – To select another language, press number buttons then ENTER to enter the corresponding 4-digit number according to the language code list on page 24. If you enter the wrong language code, press CLEAR.

DISPLAY

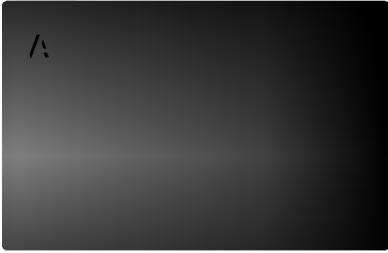

TV Aspect

4:3 – Select when a standard 4:3 TV is connected.

16:9 – Select when a 16:9 wide TV is connected.

Display Mode

Display Mode setting works only when the TV Aspect mode is set to “4:3”.

Letterbox – Displays a wide picture with bands on the upper and lower portions of the screen.

Panscan – Automatically displays the wide picture on the entire screen and cuts off the portions that do not fit.

AUDIO

Each DVD disc has a variety of audio output options. Set the receiver's AUDIO options according to the type of audio system you use.

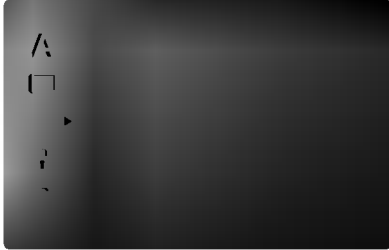

Dynamic Range Control (DRC)

With the DVD*1 format, you can hear a program's soundtrack in the most accurate and realistic presentation possible, thanks to digital audio technology. However, you may wish to compress the dynamic range of the audio output (the difference between the loudest sounds and the quietest ones). Then, you may listen to a movie at a lower volume without losing clarity of sound. Set DRC to On for this effect.

*1: Dolby Digital only

Vocal

Set Vocal to On only when a multi-channel karaoke DVD is playing. The karaoke channels on the disc will mix into normal stereo sound.

5.1 Speaker Setup

Make the following settings for the built-in 5.1 channel surround decoder.

1. Press ENTER and 5.1 Speaker Setup menu appears.

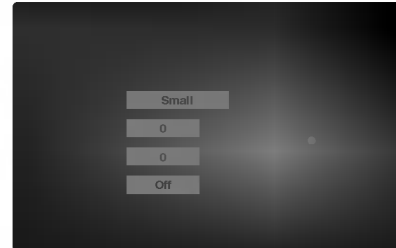

2. Use ◀ / ▶ to select the desired speaker.
3. Adjust options using ▲ / ▼ / ◀ / ▶ buttons.
4. Press ENTER to confirm your selection. Returns to the previous menu.

Speaker selection

Select a speaker that you want to adjust. (Front speakers (Left), Center Speaker, Front speakers (Right), Rear speakers (Right), Rear speakers (Left), or SubWoofer)

Note:

Certain speaker settings are prohibited by the Dolby Digital licensing agreement.

Size

Since the speaker settings are fixed, you cannot change the settings.

Volume

Press ◀ / ▶ to adjust the output level of the selected speaker. (-5dB ~ 5dB)

Distance

If you connected speakers to your DVD/CD Receiver, setting the Distance lets the speakers know how far the sound has to travel to reach your set listening point. This allows the sound from each speaker to reach the listener at the same time.

Press ◀ / ▶ to adjust the Distance of the selected speaker. (You can't adjust front / Woofer speakers)

Test

Press ◀ / ▶ to test the signals of each speaker. Adjust the volume to match the volume of test signals memorized in the system.

Front Left (L) → Center → Front Right (R) →
Rear Right (R) → Rear Left (L) → SubWoofer

LOCK (Parental Control)

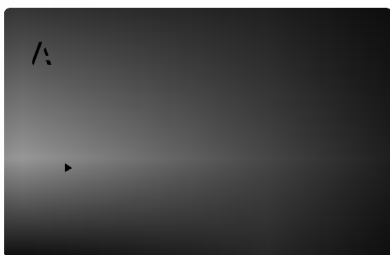

Rating

Blocks playback of rated DVDs based on their content. Not all discs are rated.

1. Select "Rating" on the LOCK menu then press ►.
2. To access the LOCK options, you must input the password you have created. If you have not yet entered password, you are prompted to do so. Input a password and press ENTER. Enter it again and press ENTER to verify. If you make a mistake before pressing ENTER, press CLEAR.

3. Select a rating from 1 to 8 using the ▲ / ▼ buttons.

Rating 1-8: Rating one (1) has the most restrictions and rating eight (8) is the least restrictive.

Unlock: If you select unlock, parental control is not active and the disc plays in full.

4. Press ENTER to confirm your rating selection, then press SETUP to exit the menu.

Password

You can enter or change password.

1. Select Password on the LOCK menu then press ►.
2. Follow step 2 as shown above (Rating). To change the password, press ENTER when the "Change" option is highlighted. Input a password and press ENTER. Enter it again and press ENTER to verify.
3. Press SETUP to exit the menu.

If you forget your password

If you forget your password, you can clear it using the following steps:

1. Press SETUP to display the Setup menu.
2. Input the 6-digit number "210499" and press ENTER. The password is cleared.

Area Code

Enter the code of the area whose standards were used to rate the DVD video disc, based on the list on page 24.

1. Select "Area Code" on the LOCK menu then press ►.
2. Follow step 2 as shown previous paragraph (Rating).
3. Select the first character using ▲ / ▼ buttons.
4. Press ► and select the second character using ▲ / ▼ buttons.
5. Press ENTER to confirm your Area code selection.

OTHERS

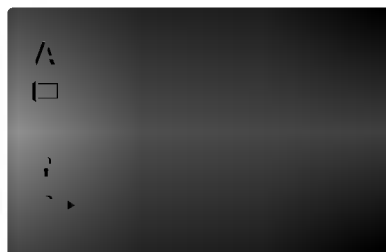

PBC

Set Playback Control (PBC) to On or Off.

On: Video CDs with PBC are played according to the PBC.

Off: Video CDs with PBC are played the same way as Audio CDs.

DivX(R) Registration

We provide you the DivX® VOD (Video On Demand) registration code that allows you to rent and purchase videos using the DivX® VOD service. For more information, visit www.divx.com/vod.

1. Select "DivX(R) Registration" option then press ►.
2. Press ENTER while "Select" is selected and the registration code will appear. Use the registration code to purchase or rent the videos from DivX® VOD service at www.divx.com/vod. Follow the instructions and download the video onto a disc for playback on this unit.
3. Press ENTER to exit.

Note:

All the downloaded videos from DivX® VOD can only be played back on this unit.

Operation

General features

| Buttons | Operations | Discs |
|------------------|--|---|
| (OPEN / CLOSE) | Opens or closes the disc tray. | ALL |
| (PAUSE) | During playback, press to pause playback. Press repeatedly to play Frame-by-Frame. | ALL DVD VCD DivX |
| SKIP (/) | During playback, press SKIP (or) to go to the next chapter/track or to return to the beginning of the current chapter/track. Press SKIP twice briefly to step back to the previous chapter/track. | ALL |
| SCAN (/) | During playback, press SCAN (or) repeatedly to select the required scan speed. DVD : 5 steps (X2, X4, X8, X16, X100) DivX disc, Video CD : 4 steps (X2, X4, X8, X16) WMA/MP3, Audio CD : 3 steps (X2, X4, X8) | DVD VCD DivX ACD MP3 WMA |
| REPEAT | During playback, press REPEAT repeatedly to select a desired repeat mode. DVD Video discs: Chapter/Title/Off Video CD, Audio CD, DivX/MP3/WMA discs: Track/All/Off | ALL |
| A-B | During playback, each press of A-B button to select point A and point B and repeats a sequence from point A (Starting point) to point B (End point). Press REPEAT A-B to exit. | DVD VCD |
| ZOOM | During playback or pause mode, press ZOOM to enlarge the video image (3 steps). You can move through the zoomed picture using buttons. | DVD VCD |
| TITLE | If the current DVD title has a menu, the title menu appears on the screen. Otherwise, the disc menu may appear. | DVD |
| DVD MENU | The disc menu appears on the screen. | DVD |
| (SUBTITLE) | During playback, press SUBTITLE repeatedly to select a desired subtitle language. | DVD DivX |
| (AUDIO language) | During playback, press AUDIO repeatedly to hear a different audio language or audio track. | DVD DivX |
| (AUDIO channel) | Press AUDIO repeatedly during playback to hear a different audio channel (STER., LEFT or RIGHT). | VCD |
| SLOW | Pause mode, press SLOW (or) to select the required speed. DVD : (1/2, 1/4, 1/8, 1/16) or (1/2, 1/4, 1/8, 1/16) Video CD : (1/2, 1/4, 1/8, 1/16) | DVD VCD |

Notes on general features:

- If you press SKIP (▶▶) once during Repeat Chapter (Track) playback, the repeat playback cancels.
- Zoom may not work on some DVDs.
- The A-B repeat function is available only in the current title.

Additional features

Time Search **DVD** **VCD** **DivX**

To start playing at any chosen time on the disc:

1. Press DISPLAY during playback.
2. Press ▲ / ▼ to select the time clock icon and "--:--:--" appears.
3. Input the required start time in hours, minutes, and seconds from left to right. If you enter the wrong numbers, press CLEAR to remove the numbers you entered. Then input the correct numbers.
4. Press ENTER to confirm. Playback starts from the selected time.

Marker Search **DVD** **VCD** **DivX**

To enter a Marker

You can start playback from up to nine memorized points. To enter a marker, press MARKER at the desired point on the disc. The Marker icon appears on the TV screen briefly. Repeat to enter up to nine markers.

To Recall or Clear a Marked Scene

1. During disc playback, press SEARCH. The marker search menu appears on the screen.
2. Within 10 seconds, press ◀ / ▶ to select a marker number that you want to recall or clear.
3. Press ENTER and playback starts from the marked scene. Or, Press CLEAR and the marker number is erased from the list.
4. You can play any marker by inputting its number on the marker search menu.

Screen Saver

The screen saver appears when you leave the unit in Stop mode for about five minutes.

Last Scene Memory **DVD**

This receiver memorizes last scene from the last disc that is viewed. The last scene remains in memory even if you remove the disc from the receiver or switch off the receiver. If you load a disc that has the scene memorized, the scene is automatically recalled.

Note:

This receiver does not memorize the scene of a disc if you switch off the receiver before commencing to play the disc.

System Select

You must select the appropriate system mode for your TV system. If NO DISC appears in the display window, press and hold P./STEP on the front panel or remote control for more than 5 seconds to be able to select a system (PAL, NTSC).

- When the selected system does not coincide with the system of your TV, normal colour picture may not be displayed.

NTSC: Select when DVD/CD Receiver is connected with NTSC-TV.

PAL: Select when DVD/CD Receiver is connected with PAL-TV.

Playing an Audio CD or MP3/WMA file

This unit can play Audio CDs or MP3/WMA files recorded media.

MP3/ WMA/ Audio CD

Once you insert an MP3/WMA files recorded media or Audio CD, a menu appears on the TV screen.

Press ▲ / ▼ to select a track/file then press PLAY or ENTER and playback starts. You can use variable playback functions. Refer to page 16.

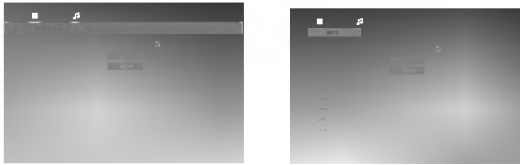

Tips:

- Press MENU to move to the next page.
- On a CD with MP3/WMA and JPEG you can switch MP3/WMA and JPEG. Press TITLE and MUSIC or PHOTO word on top of the menu is highlighted.

MP3 / WMA disc compatibility with this player is limited as follows:

- Sampling frequency: within 32 - 48 kHz (MP3), within 24 - 48kHz (WMA)
- Bit rate: within 32 - 320kbps (MP3), 40 - 192kbps (WMA)
- The DVD/CD Receiver cannot read an MP3/WMA file that has a file extension other than ".mp3" / ".wma".
- CD-R physical format should be ISO 9660
- If you record MP3 / WMA files using software that cannot create a file system (eg. Direct-CD) it is impossible to playback MP3 / WMA files. We recommend that you use Easy-CD Creator, which creates an ISO 9660 file system.
- File names should have a maximum of 8 letters and must incorporate an .mp3 or .wma extension.
- They should not contain special letters such as / ? * : " < > | etc.
- The total number of files on the disc should be less than 999.

This DVD/CD Receiver requires discs and recordings to meet certain technical standards in order to achieve optimal playback quality. Pre-recorded DVDs are automatically set to these standards. There are many different types of recordable disc formats (including CD-R containing MP3 or WMA files) and these require certain pre-existing conditions (see above) to ensure compatible playback.

Customers should note that permission is required in order to download MP3 / WMA files and music from the Internet. Our company has no right to grant such permission. Permission should always be sought from the copyright owner.

Programmed Playback

The program function enables you to store your favorite tracks from any disc in the receiver memory. A program can contain 300 tracks.

1. Insert a disc.
Audio CD and MP3/WMA Discs:
2. Select a track on the "List", then press PROG. or select "➡ (Add)" icon then press ENTER to place the selected track on the "Program" list. Repeat to place additional tracks on the list.

Note:

You can add all tracks in the disc. Select "➡ (Add All)" icon then press ENTER.

3. Select the track you want to start playing on the "Program" list. Press MENU to move to the next page.
4. Press PLAY or ENTER to start. Playback begins in the order in which you programmed the tracks. Playback stops after all of the tracks on the "Program" list have played once.
5. To resume normal playback from programmed playback, select a track of AUDIO CD (or MP3/WMA) list and then press PLAY.

Repeat Programmed Tracks

1. Press REPEAT when playing a disc. The repeat icon appears.
2. Press REPEAT to select a desired repeat mode.
 - TRACK: repeats the current track
 - ALL: repeats all the tracks on programmed list.
 - Off(No display): does not play repeatedly.

Erasing a Track from "Program" List

1. Use ▲ ▼ to select the track that you wish to erase from the Program list.
2. Press CLEAR. Alternatively, select "⊗ (Delete)" icon then press ENTER to place the selected track on the Program list. Repeat to erase additional tracks on the list.

Erasing the Complete Program List

Use ▲ / ▼ to select "⊗ (Del all)", then press ENTER.

Note:

The programs are also cleared when the disc is removed.

Viewing a JPEG file

This unit can play discs with JPEG files.
Before playing JPEG recordings, read the notes on JPEG Recordings on right.

1. Insert a disc and close the tray.
The PHOTO menu appears on the TV screen.



2. Press ▲ / ▼ to select a folder, and press ENTER. A list of files in the folder appears.
If you are in a file list and want to return to the previous Folder list, use the ▲ / ▼ buttons on the remote to highlight  and press ENTER.
3. If you want to view a particular file, press ▲ / ▼ to highlight a file and press ENTER or PLAY. While viewing a file, you can press STOP to move to the previous menu (JPEG menu).

Tips:

- There are four Slide Speed options  :
> (Slow), >> (Normal), >>> (Fast) and II (off).
Use ▲ / ▼ / ◀ / ▶ to highlight the Speed. Then, use ◀ / ▶ to select the option you want to use then press ENTER.
- If you set Speed option to Off, Slide is not active.

Slide Show

Use ▲ ▼ ◀ ▶ to highlight the  (Slide Show) then press ENTER.

Still Picture

1. Press PAUSE/STEP during slide show.
The DVD/CD Receiver will now go into PAUSE mode.
2. To return to the slide show, press PLAY or press PAUSE/STEP again.

Moving to another File

Press SKIP (◀◀ or ▶▶) once while viewing a picture to advance to the next or previous file.

To rotate picture

Press ◀ / ▶ during showing a picture to rotate the picture clockwise or counter-clockwise.

Zoom

Each time press ZOOM the setting change in the following order.

Zoom on ↔ Zoom off

Press ▲/▶/▶▶ to enlarge the video image.
Press ▼/◀/◀◀ to reduce the video image.

JPEG disc compatibility with this player is limited as follows:

- Depending upon the size and number of JPEG files, it could take a long time for the DVD/CD Receiver to read the disc's contents. If you don't see an on-screen display after several minutes, some of the files may be too large — reduce the resolution of the JPEG files to less than 2M pixels as 2760 x 2048 pixels and burn another disc.
- The total number of files and folders on the disc should be less than 999.
- Some discs may be incompatible due to a different recording format or the condition of disc.
- Ensure that all the selected files have the “.jpg” extensions when copying into the CD layout.
- If the files have “.jpe” or “.jpeg” extensions, please rename them as “.jpg” file.
- File names without “.jpg” extension will not be able to be read by this DVD/CD Receiver. Even though the files are shown as JPEG image files in Windows Explorer.

Playing a DivX Movie file

Using this DVD/CD Receiver you can play DivX disc.

1. Insert a disc and close the tray. The MOVIE menu appears on the TV screen.

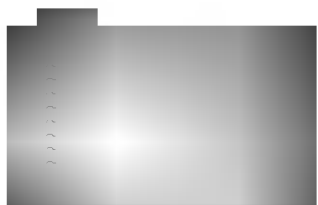

2. Press ▲ / ▼ to select a folder, and press ENTER. A list of files in the folder appears. If you are in a file list and want to return to the Folder list, use the ▲ / ▼ buttons on the remote to highlight [EXIT] and press ENTER.
3. If you want to view a particular file, press ▲ / ▼ to highlight a file and press ENTER or PLAY.
4. Press STOP to exit.

Tips:

- Press MENU to move to the next page.
- On a CD with MP3/WMA, JPEG and MOVIE file, you can switch MUSIC, PHOTO and MOVIE menu. Press TITLE and MUSIC, PHOTO and MOVIE word on top of the menu is highlighted.

Notes:

- Be sure to select "SUBTITLE ON" mode by pressing the subtitle file every time before playing a DivX file .
- When the subtitle has more than two languages in the file, original subtitle is only available.
- The DivX files in your memory card can not be played.
- You can not adjust sound mode and VIRTUAL sound during the DivX file playing.

Notice for displaying the Divx subtitle

If the subtitle does not display properly during playback, press and hold S-TITLE about 3 seconds then press S-TITLE to select another language code until the subtitle is displayed properly

DivX disc compatibility with this player is limited as follows:

- Available resolution size of the DivX file is under 800x600 (W x H) pixel.
- The file name of the DivX subtitle is available by 45 characters.
- If there is impossible code to express in the DivX file, it may be displayed as " _ " mark on the display.
- **If the number of the screen frame is over 30 per 1 second, this unit may not operate normally.**
- **If the video and audio structure of recorded file is not interleaved, either video or audio is outputted.**

Playable DivX file

- ".avi ", ".mpg ", ".mpeg ", ".divx"

Playable Subtitle format

SubRip(*.srt/*.txt)
SAMI(*.smi)
SubStation Alpha(*.ssa/*.txt)
MicroDVD(*.sub/*.txt)
SubViewer 2.0(*.sub/*.txt)
VobSub(*.sub)

Playable Codec format

- "DIVX3.xx ", "DIVX4.xx ", "DIVX5.xx ", "XVID ", "MP43 ", "3IVX "

Playable Audio format

- "AC3 ", "DTS ", "PCM ", "MP3 ", "WMA "
- Sampling frequency: within 32 - 48 kHz (MP3), within 24 - 48kHz (WMA)
- Bit rate: within 32 - 320kbps (MP3), 40 - 192kbps (WMA)

Presetting the Radio Stations

You can preset 50 stations for FM and AM (MW). Before tuning, make sure that you have turned down the volume.

1. Press BAND on the remote control until FM or AM (MW) appears in the display window.
2. And then every time you press BAND, FM and AM (MW) changes alternately.
3. Press and hold TUN.(-/+) for about two seconds until the frequency indication starts to change, then release.
Scanning stops when the DVD/CD Receiver tunes in a station.
4. Press PROG./MEMO. on the remote control.
A preset number will flash in the display window.
5. Press PRESET +/- on the remote control to select the preset number you want.
6. Press PROG./MEMO on the remote control again.
The station is stored.
7. Repeat steps 3 to 6 to store other stations.

To tune in a station with a weak signal

Press TUN.(-/+) repeatedly in step 3 to tune in the station manually.

To clear all the stored stations

Press and hold PROG./MEMO. for about two seconds and "ERASE ALL" is appeared in the display window and then press PROG./MEMO. again, the stations are cleared.

- If you have accidentally entered into the "ERASE ALL" mode and you do not wish to clear the memory, do not press any key. After a few seconds, the "ERASE ALL" display will go off by itself and change to normal mode.

Note:

If all stations have already been entered, the FULL message will appear in the display window for a moment and then a preset number will flash. To change the preset number, follow the steps 5-6 as above.

Listening to the Radio

Preset radio stations in the DVD/CD Receiver's memory first (see "Presetting radio stations" on the left).

1. Press BAND until FM or AM (MW) appears in the display window.
The last received station is tuned in.
2. Press PRESET +/- repeatedly on the remote control to select the preset station you want.
Each time you press the button, the DVD/CD Receiver tunes in one preset station at a time.
3. Adjust the volume by rotating VOLUME on the front panel or by pressing VOLUME + or - on the remote control repeatedly.

To turn off the radio

Press POWER to turn the DVD/CD Receiver off or select another function mode (DVD/CD, AUX, USB).

To listen to non-preset radio stations

- Use manual or automatic tuning in step 2.
- For manual tuning, press TUN.(-/+) repeatedly.
- For automatic tuning, press and hold TUN.(-/+) for about two seconds on the front panel.

To select a preset radio station directly

You can use the number buttons on the remote control to select a preset radio station directly. For example, to listen to preset station 4, press 4 on the remote control. To listen to preset station 19, press 1 then 9 (within 3 seconds).

For your reference

- **If an FM program is noisy**
Press MONO/ST. on the front panel so that "ST." disappears in the display window. There will be no stereo effect, but the reception will improve. Press the button again to restore the stereo effect.
- **To improve reception**
Reorient the supplied antennas.

RDS Operation

This unit is equipped with RDS (Radio Data System), which brings a wide range of information to FM radio. Now in use in many countries, RDS is a system for transmitting station call signs or network information, a description of station programme type text message about the station or specifics of musical selection and the correct time.

RDS TUNING

When a FM station is tuned in and it contains RDS data, the unit will automatically display the station's call sign and the RDS indicator will light in the Display Window as well as indicators for the RDS services programme (PS), programme type recognition (PTY), Radiotext (RT) and Clock Time (CT) if transmitted by the station.

RDS DISPLAY OPTIONS

The RDS system is capable of transmitting a wide variety of information in addition to the initial call sign that appears when a station is first tuned. In normal RDS operation the display will indicate the station name, broadcast network or call letters. Pressing **RDS** on the remote control enables you to cycle through the various data types in the sequence:

(PS ↔ FREQUENCY ↔ PTY ↔ RT ↔ CT)

- **PS (Programme Service name)**- The name of the channel is shown in the Display Window.
- **PTY (Programme type recognition)**- The name of the programme type is shown in the Display Window.
- **RT (Radiotext)**- A "text" message contains special information from the broadcast station. Note that this message may scroll across the display to permit message.
- **CT (Time controlled by the channel)**- Enables the unit to receive the actual time and show it in the Display Window.

Note:

Some RDS stations may not choose to include some of these additional features. If the data required for the selected mode is not being transmitted, the Display Window will show a **PTY NONE, RT NONE, CT NONE, PS NONE** message.

Programme Search (PTY)

A major benefit of RDS is its ability to encode broadcasts with Programme Type (PTY) codes that indicate the type of material being broadcast. The following list shows the abbreviations used to indicate each PTY along with an explanation of the PTY.

| | |
|----------|---------------------------------|
| NEWS | News |
| AFFAIRS | Current Affairs |
| INFO | Information |
| SPORT | Sports |
| EDUCATE | Educational |
| DRAMA | Drama |
| CULTURE | Culture |
| SCIENCE | Science |
| VARIED | Varied Speech Programme |
| POP M | Popular Music |
| ROCK M | Rock Music |
| EASY M | Easy Listening Music |
| LIGHT M | Light Music |
| CLASSICS | Classical Music |
| OTHER M | Other Music |
| WEATHER | Weather Information |
| FINANCE | Financial Programmes |
| CHILDREN | Children's Programmes |
| SOCIAL | Social Affairs Programmes |
| RELIGION | Religious Broadcasts |
| PHONE IN | Phone-In Programmes |
| TRAVEL | Travel and Touring |
| LEISURE | Leisure and Hobby |
| JAZZ | Jazz Music |
| COUNTRY | Country Music |
| NATION M | National Music |
| OLDIES | Oldies Music |
| FOLK M | Folk Music |
| DOCUMENT | Documentary Programmes |
| TEST | Station Alarm Test Message |
| ALARM 1 | Emergency Broadcast Information |

You may search for a specific Programme Type (PTY) by following these steps:

1. Press **BAND** to select FM mode.
2. Press **PTY** on the remote control, the display will show the last PTY in use.
3. Press **PTY** repeatedly to select a desired PTY.
4. When the PTY is selected, press **TUN.(-/+)**. The unit will go into an automatic search mode. When a station is tuned, the search will stop.

Sleep Timer Setting

You can set the DVD/CD Receiver to turn off automatically at a specified time.

1. Press SLEEP to set the desired sleep time.

The SLEEP indicator and sleep time appears in the display window.

2. Each time you press SLEEP the setting changes in the following order.

SLEEP 180 → 150 → 120 → 90 → 80 → 70 → 60 → 50 → 40 → 30 → 20 → 10 → OFF

Note:

You can check the time remaining before the DVD/CD Receiver turns off. Press SLEEP. The remaining time appears in the display window.

Dimmer

This function will change the brightness of the display window on the front panel during in power-on status. Press the DIMMER repeatedly.

Mute

Press MUTE to mute your unit.

You can mute your unit in order, for example, to answer the telephone, "MUTE" indicator flashes in the display window.

Using Headphone Jack

Connect a stereo headphone plug (ø3.5mm) into the **PHONES connector**.

The speakers are automatically disconnected when you plug in a headphone (not supplied).

Selecting input source

You can use VCRs or other units connected to the AUX IN, EURO AV connector. Refer to the owner's manual supplied with the unit for further information on the operation.

Press AUX repeatedly on the remote control to select the desired input source.

Each time you press this button, the mode of the function changes in the following sequence:

- **AUX** : for selecting the analog signal from AUX AUDIO IN (L/R) Connectors.
- **TV-AUDIO**: for selecting the TV audio signal from SCART.

Note:

You can also select the input source by pressing FUNC. button on the front panel. Press and hold down this button about 3 seconds, then press repeatedly to select input source.

XTS/XTS pro

Each time you press **XTS pro** the setting changes in the following order.

XTS ON → NORMAL → XTS-P ON...

- **XTS-P ON**

The unique sound quality of the LG Technology creates the optimum sound for you to play the perfect playback of the original sound and to feel the living sound source.

- **XTS ON**

When playing the movie with the weak bass sound relatively to the general music, it enforces the sense of sound at woofer for you to satisfy with. In the mode of 2 CH BYPASS, It creates the high display effect by playing the sound source via the rear speakers same as the front speakers.

Note:

The XTS mode is temporarily disabled when changing from 2.1 CH to 5.1 CH and it is enabled when changing it to 2.1 CH.

- **NORMAL**

XTS-P and XTS mode tune off

VIRTUAL sound

press **VIRTUAL** the setting VIRTUAL sound.

| Source | Display | Effect |
|---------|---------|--------------------|
| 2.1 ch. | VIRTUAL | 3D STEREO |
| 5.1 ch | VIRTUAL | Multichannel sound |

- **3D STEREO**

Realtime 3D positioned sound rendering technology with stereo sources, optimized for stereo speakers. Listeners may experience amazing virtual surround effects with their own multimedia players.

- **Multichannel sound**

The Multichannel sound makes a 5.1 ch feel 10.1 ch sound therefore this mode provides a emotion which you are involved with sound and you can feel detailed sound.

Sound Mode

You can enjoy surround sound simply by selecting one of the pre-programmed sound fields according to the program you want to listen to (2 ch. sound only) .

BYPASS → ON STAGE → STUDIO → CLUB → HALL → THEATER 1 → CHURCH → PL II MOVIE → PL II MUSIC → PL II MTRX → BYPASS...

Note:

Initial sound mode is BYPASS.

Language Codes

Use this list to input your desired language for the following initial settings:
Disc Audio, Disc Subtitle, Disc Menu.

| Language | Code | Language | Code | Language | Code | Language | Code |
|-----------------|------|------------------|------|----------------|------|------------|------|
| Abkhazian | 6566 | Fiji | 7074 | Lingala | 7678 | Singhalese | 8373 |
| Afar | 6565 | Finnish | 7073 | Lithuanian | 7684 | Slovak | 8375 |
| Afrikaans | 6570 | French | 7082 | Macedonian | 7775 | Slovenian | 8376 |
| Albanian | 8381 | Frisian | 7089 | Malagasy | 7771 | Somali | 8379 |
| Ameharic | 6577 | Galician | 7176 | Malay | 7783 | Spanish | 6983 |
| Arabic | 6582 | Georgian | 7565 | Malayalam | 7776 | Sudanese | 8385 |
| Armenian | 7289 | German | 6869 | Maltese | 7784 | Swahili | 8387 |
| Assamese | 6583 | Greek | 6976 | Maori | 7773 | Swedish | 8386 |
| Aymara | 6588 | Greenlandic | 7576 | Marathi | 7782 | Tagalog | 8476 |
| Azerbaijani | 6590 | Guarani | 7178 | Moldavian | 7779 | Tajik | 8471 |
| Bashkir | 6665 | Gujarati | 7185 | Mongolian | 7778 | Tamil | 8465 |
| Basque | 6985 | Hausa | 7265 | Nauru | 7865 | Tatar | 8484 |
| Bengali; Bangla | 6678 | Hebrew | 7387 | Nepali | 7869 | Telugu | 8469 |
| Bhutani | 6890 | Hindi | 7273 | Norwegian | 7879 | Thai | 8472 |
| Bihari | 6672 | Hungarian | 7285 | Oriya | 7982 | Tibetan | 6679 |
| Breton | 6682 | Icelandic | 7383 | Panjabi | 8065 | Tigrinya | 8473 |
| Bulgarian | 6671 | Indonesian | 7378 | Pashto, Pushto | 8083 | Tonga | 8479 |
| Burmese | 7789 | Interlingua | 7365 | Persian | 7065 | Turkish | 8482 |
| Byelorussian | 6669 | Irish | 7165 | Polish | 8076 | Turkmen | 8475 |
| Cambodian | 7577 | Italian | 7384 | Portuguese | 8084 | Twi | 8487 |
| Catalan | 6765 | Japanese | 7465 | Quechua | 8185 | Ukrainian | 8575 |
| Chinese | 9072 | Javanese | 7487 | Rhaeto-Romance | 8277 | Urdu | 8582 |
| Corsican | 6779 | Kannada | 7578 | Rumanian | 8279 | Uzbek | 8590 |
| Croatian | 7282 | Kashmiri | 7583 | Russian | 8285 | Vietnamese | 8673 |
| Czech | 6783 | Kazakh | 7575 | Samoan | 8377 | Volapük | 8679 |
| Danish | 6865 | Kirghiz | 7589 | Sanskrit | 8365 | Welsh | 6789 |
| Dutch | 7876 | Korean | 7579 | Scots Gaelic | 7168 | Wolof | 8779 |
| English | 6978 | Kurdish | 7585 | Serbian | 8382 | Xhosa | 8872 |
| Esperanto | 6979 | Laothian | 7679 | Serbo-Croatian | 8372 | Yiddish | 7473 |
| Estonian | 6984 | Latin | 7665 | Shona | 8378 | Yoruba | 8979 |
| Faroese | 7079 | Latvian, Lettish | 7686 | Sindhi | 8368 | Zulu | 9085 |

Area Codes

Choose a area code from this list.

| Area | Code | Area | Code | Area | Code | Area | Code |
|----------------|------|----------------------------|------|----------------------|------|-----------------|------|
| Afghanistan | AF | Ethiopia | ET | Malaysia | MY | Saudi Arabia | SA |
| Argentina | AR | Fiji | FJ | Maldives | MV | Senegal | SN |
| Australia | AU | Finland | FI | Mexico | MX | Singapore | SG |
| Austria | AT | France | FR | Monaco | MC | Slovak Republic | SK |
| Belgium | BE | Germany | DE | Mongolia | MN | Slovenia | SI |
| Bhutan | BT | Great Britain | GB | Morocco | MA | South Africa | ZA |
| Bolivia | BO | Greece | GR | Nepal | NP | South Korea | KR |
| Brazil | BR | Greenland | GL | Netherlands | NL | Spain | ES |
| Cambodia | KH | Heard and McDonald Islands | HM | Netherlands Antilles | AN | Sri Lanka | LK |
| Canada | CA | Hong Kong | HK | New Zealand | NZ | Sweden | SE |
| Chile | CL | Hungary | HU | Nigeria | NG | Switzerland | CH |
| China | CN | India | IN | Norway | NO | Taiwan | TW |
| Colombia | CO | Indonesia | ID | Oman | OM | Thailand | TH |
| Congo | CG | Israel | IL | Pakistan | PK | Turkey | TR |
| Costa Rica | CR | Italy | IT | Panama | PA | Uganda | UG |
| Croatia | HR | Jamaica | JM | Paraguay | PY | Ukraine | UA |
| Czech Republic | CZ | Japan | JP | Philippines | PH | United States | US |
| Denmark | DK | Kenya | KE | Poland | PL | Uruguay | UY |
| Ecuador | EC | Kuwait | KW | Portugal | PT | Uzbekistan | UZ |
| Egypt | EG | Libya | LY | Romania | RO | Vietnam | VN |
| El Salvador | SV | Luxembourg | LU | Russian Federation | RU | Zimbabwe | ZW |

Troubleshooting

Check the following guide for the possible cause of a problem before contacting service.

| Symptom | Cause | Correction |
|--|---|---|
| No power. | <ul style="list-style-type: none"> The power cord is disconnected. | <ul style="list-style-type: none"> Plug the power cord securely into the wall outlet. |
| The power is on, but the DVD/CD Receiver does not work. | <ul style="list-style-type: none"> No disc is inserted. | <ul style="list-style-type: none"> Insert a disc. (Check that the DVD or, audio CD indicator in the DVD display is lit.) |
| No picture. | <ul style="list-style-type: none"> The TV is not set to receive DVD signal output. | <ul style="list-style-type: none"> Select the appropriate video input mode on the TV so the picture from the DVD/CD Receiver appears on the TV screen. |
| | <ul style="list-style-type: none"> The video cable is not connected securely. | <ul style="list-style-type: none"> Connect the video cable into the jacks securely. |
| | <ul style="list-style-type: none"> The connected TV power is turned off. | <ul style="list-style-type: none"> Turn on the TV. |
| There is no sound or only a very low-level sound is heard. | <ul style="list-style-type: none"> The equipment connected with the audio cable is not set to receive DVD signal output. | <ul style="list-style-type: none"> Select the correct input mode of the audio receiver so you can hear the sound from the DVD/CD Receiver. |
| | <ul style="list-style-type: none"> The audio cables are not connected securely. | <ul style="list-style-type: none"> Connect the audio cable into the jacks securely. |
| | <ul style="list-style-type: none"> The power of the equipment connected with the audio cable is turned off. | <ul style="list-style-type: none"> Turn on the equipment connected with the audio cable. |
| | <ul style="list-style-type: none"> The audio connecting cable is damaged. | <ul style="list-style-type: none"> Replace it with new one. |
| The playback picture is poor. | <ul style="list-style-type: none"> The disc is dirty. | <ul style="list-style-type: none"> Clean the disc. |
| The DVD/CD Receiver does not start playback. | <ul style="list-style-type: none"> No disc is inserted. | <ul style="list-style-type: none"> Insert a disc. (Check that the DVD, or audio CD indicator in the DVD display is lit.) |
| | <ul style="list-style-type: none"> An unplayable disc is inserted. | <ul style="list-style-type: none"> Insert a playable disc. (Check the disc type, colour system and Regional code.) |
| | <ul style="list-style-type: none"> The disc is placed upside down. | <ul style="list-style-type: none"> Place the disc with the playback side down. |
| | <ul style="list-style-type: none"> The disc is not placed within the guide. | <ul style="list-style-type: none"> Place the disc on the disc tray correctly inside the guide. |
| | <ul style="list-style-type: none"> The disc is dirty. | <ul style="list-style-type: none"> Clean the disc. |
| | <ul style="list-style-type: none"> A menu is on the TV screen. | <ul style="list-style-type: none"> Press the SETUP button to turn off the menu screen. |
| | <ul style="list-style-type: none"> The Rating level is set. | <ul style="list-style-type: none"> Cancel the Rating function or change the rating level. |
| Loud hum or noise is heard. | <ul style="list-style-type: none"> The disc is dirty. | <ul style="list-style-type: none"> Clean the disc. |
| | <ul style="list-style-type: none"> The speakers and components are connected poorly. | <ul style="list-style-type: none"> Connect the speakers and components securely. |
| | <ul style="list-style-type: none"> The DVD/CD Receiver is located too close to the TV. | <ul style="list-style-type: none"> Move your TV away from the audio components. |

| Symptom | Cause | Correction |
|--|--|--|
| Radio stations cannot be tuned in. | <ul style="list-style-type: none"> The antenna is positioned or connected poorly. | <ul style="list-style-type: none"> Connect the antenna securely. Adjust the antennas and connect an external antenna if necessary. |
| | <ul style="list-style-type: none"> The signal strength of the stations is too weak (when tuning in with automatic tuning). | <ul style="list-style-type: none"> Tune in the station manually. |
| | <ul style="list-style-type: none"> No stations have been preset or preset stations have been cleared (when tuning by scanning preset stations). | <ul style="list-style-type: none"> Preset the stations (page 21). |
| The remote control does not work properly. | <ul style="list-style-type: none"> The remote control is not pointed at the remote sensor of the DVD/CD Receiver. | <ul style="list-style-type: none"> Point the remote control at the remote sensor of the DVD/CD Receiver. |
| | <ul style="list-style-type: none"> The remote control is too far from the DVD/CD Receiver. | <ul style="list-style-type: none"> Use the remote control within about 23 ft (7 m). |
| | <ul style="list-style-type: none"> There is an obstacle in the path of the remote control and the DVD/CD Receiver. | <ul style="list-style-type: none"> Remove the obstacle. |
| | <ul style="list-style-type: none"> The batteries in the remote control are flat. | <ul style="list-style-type: none"> Replace the batteries with new ones. |
| The front panel display is too dim. | <ul style="list-style-type: none"> Nothing is displayed on the front panel display. | <ul style="list-style-type: none"> Press DIMMER on the remote control. |

Specifications

| | | | | |
|-----------------|---|--|---|--|
| General | Power supply | Refer to main label | | |
| | Power consumption | Refer to main label | | |
| | Net Weight | 3.9 kg | | |
| | External dimensions (W x H x D) | 430 x 57 x 295 mm | | |
| | Operating conditions | Temperature: 5°C to 35°C, Operation status: Horizontal | | |
| | Operating humidity | 5% to 85% | | |
| CD/DVD | Laser | Semiconductor laser, wavelength 650 nm | | |
| | Signal system | PAL 625/50, NTSC 525/60 | | |
| | Frequency response (audio) | 150 Hz to 18 kHz | | |
| | Signal-to-noise ratio (audio) | More than 75 dB (1 kHz, NOP -6 dB, 20 kHz LPF/A-Filter) | | |
| | Dynamic range (audio) | More than 70 dB | | |
| | Harmonic distortion (audio) | 0.5 % (1 kHz, at 1W position) (20 kHz LPF) | | |
| Video | Video output | 1.0 V (p-p), 75 Ω, negative sync., SCART (TO TV) | | |
| Tuner | FM | Tuning Range | 87.5 - 108.0 MHz or 65.0 - 74.0 MHz, 87.5 - 108.0 MHz | |
| | | Intermediate Frequency | 10.7 MHz | |
| | | Signal-to Noise Ratio | 60 dB (Mono) | |
| | | Frequency Response | 140 - 8,000 Hz | |
| | AM [MW] | Tuning Range | 522 - 1,620 kHz or 520 - 1,720 kHz | |
| | | Intermediate Frequency | 450 kHz | |
| Amplifier | Stereo mode | 45W + 45W (Rated Output Power 30W, 4Ω at 1 kHz, THD 10 %) | | |
| | Surround mode (* Depending on the sound mode settings and the source, there may be no sound output.) | Front: 45W + 45W (Rated Output Power 30W, THD 10 %) Centre*: 45W Surround*: 45W + 45W (Rated Output Power 30W, 4Ω at 1 kHz, THD 10 %) Subwoofer*: 75W (Rated Output Power 60W, 8Ω at 30 Hz, THD 10 %) | | |
| | Inputs | AUX IN | | |
| | Outputs | MONITOR, PHONES: (32 Ω, 1.0 V) | | |
| | | | | |
| Speakers | | Front/Rear/Center Speaker (LHS-36SES) | Passive Subwoofer (LHS-36SEW) | |
| | Type | 1 Way 1 Speaker | 1 Way 1 Speaker | |
| | Impedance | 4 Ω | 8 Ω | |
| | Frequency Response | 150 - 20,000 Hz | 65 - 1,500 Hz | |
| | Sound Pressure Level | 85 dB/W (1m) | 87 dB/W (1m) | |
| | Rated Input Power | 45 W | 75 W | |
| | Max. Input Power | 90 W | 150 W | |
| | Net Dimensions (W x H x D) | 105 x 99 x 83 mm | 175 x 351 x 270 mm | |
| | Net Weight | 0.45kg | 3.4kg | |
| Wireless system | Wireless TX | Transmission Output | 2.4GHz | |
| | | Power Supply | DC 7V | |
| | Wireless RX | Power requirements | Refer to label of wireless RX | |
| | | Power consumption | Refer to label of wireless RX | |
| | | Reception Output | 2.4GHz | |

* Designs and specifications are subject to change without notice.



P/NO : 3834RH0138K