

# Colour Television OWNER'S MANUAL

Please read this manual carefully before operating your set.  
Retain it for future reference.  
Record model number and serial number of the set.  
See the label attached on the back cover and quote this information to your dealer when you require service.

Model number :  
Serial number :

---

# Contents

---

<b>Installation</b>	<b>3</b>
<b>Location and function of controls</b>	<b>4</b>
Remote control handset	
Battery installation	
Front panel	
<b>Basic operation</b>	<b>7</b>
On and off / Programme selection	
Volume adjustment / Quick view	
Mute function / Auto Demonstration	
On screen language selection (option)	
<b>On screen menus</b>	<b>8</b>
Menu selection	
<b>Setting up TV stations</b>	<b>9</b>
Auto programme tuning	
Manual programme tuning	
Fine Tuning / Programme edit	
Favourite programme	
Calling the programme table	
<b>Picture adjustment</b>	<b>14</b>
PSM (Picture Status Memory)	
Picture adjustment	
Picture format / Eye (option)	
Turbo picture selection (option)	
<b>Sound adjustment</b>	<b>17</b>
SSM (Sound Status Memory) / Sound adjustment	
Turbo sound selection (option)	
Sound output selection / Stereo/Dual reception	
NICAM reception (option)	
<b>Time setting</b>	<b>20</b>
Setting the clock / Setting the On/Off timer	
Auto sleep	
<b>Other functions</b>	<b>21</b>
TV and AV modes / Auto AV switching (option)	
Child lock / Blue back (option)	
Tilt / Degaussing (option) / Sleep timer	
<b>PIP operation (option)</b>	<b>23</b>
On and off / Input mode selection for sub picture	
Swapping between main and sub pictures	
Programme selection for sub picture	
Sub picture size / Sub picture freeze	
Sub picture position change / Programme scan	
<b>Teletext (option)</b>	<b>24</b>
Switch on/off	
SIMPLE text / TOP text (option)	
FASTEXT / Special teletext functions	
<b>Connection of external equipment</b>	<b>27</b>
Aerial socket	
Euro scart sockets (option)	
Audio/Video in sockets (option)	
S-Video/Audio in sockets (S-AV) (option)	
Component in sockets (option)	
Monitor out sockets	
RF out sockets	
Headphone socket (option)	
<b>Troubleshooting check list</b>	<b>31</b>

---

---

# Installation

---

## Power

This set operates on an AC mains supply, the voltage is as indicated on the label on the back cover. Never apply DC power to the set. In the event of thunderstorms or powercuts, please pull out the aerial and mains plugs.

## Warning

To prevent fire or shock hazard, do not expose the set to rain or moisture.

Do not place anything containing liquid on top of the set, this may cause a fire or could give an electric shock.

## Service

Never remove the back cover of the set as this can expose you to very high voltage and other hazards. If the set does not operate properly, unplug it and call your dealer.

## Aerial

Connect the aerial cable to the socket marked  $75\ \Omega$  on the back cover. For the best reception an outdoor aerial should be used.

## Location

Position your set so that no bright light or sunlight falls directly onto the screen. Care should be taken not to expose the set to any unnecessary vibration, moisture, dust or heat. Also ensure that the set is placed in a position to allow a free flow of air. Do not cover the ventilation openings on the back cover.

# Location and function of controls

All the functions can be controlled with the remote control handset. Some functions can also be adjusted with the buttons on the front panel of the set.

## Remote control handset

Before you use the remote control handset, please install the batteries. See the next page.

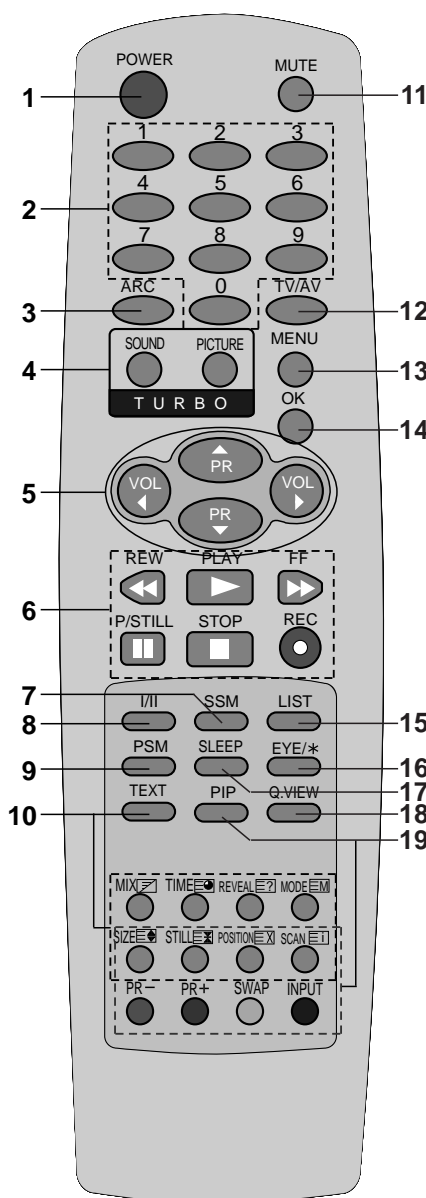

(With PIP)

1. **POWER**  
switches the set on from standby or off to standby.
2. **NUMBER BUTTONS**  
switches the set on from standby or directly select a number.
3. **ARC (Aspect Ratio Control)**  
changes the picture format.
4. **TURBO SOUND BUTTON**  
selects Turbo sound.
5. **TURBO PICTURE BUTTON**  
selects Turbo picture.
6. **▲ / ▼ (Programme Up/Down)**  
selects a programme or a menu item.  
**◀ / ▶ (Volume Down/Up)**  
adjusts the volume.  
adjusts menu settings.
7. **VCR BUTTONS**  
control a LG video cassette recorder.
8. **SSM (Sound Status Memory)**  
recalls your preferred sound setting.
9. **I/II**  
selects the language during dual language broadcast.
10. **PSM (Picture Status Memory)**  
recalls your preferred picture setting.
11. **TELETEXT BUTTONS (option)**  
These buttons are used for teletext.  
For further details, see the 'Teletext' section.
12. **MUTE**  
switches the sound on or off.
13. **TV/AV**  
selects TV or AV mode.  
switches the set on from standby.
14. **MENU**  
selects a menu.
15. **OK**  
accepts your selection or displays the current mode.

## Location and function of controls

- 15. LIST**  
displays the programme table.
- 16. EYE/\* (option)**  
switches the eye function on or off.
- 17. SLEEP**  
sets the sleep timer.
- 18. Q.VIEW**  
returns to the previously viewed programme.  
selects a favourite programme.
- 19. PIP BUTTONS (option)**  
**PIP**  
switches the sub picture on or off.  
**PR +/-**  
selects a programme for the sub picture.  
**SWAP**  
alternates between main and sub picture.  
**INPUT**  
selects the input mode for the sub picture.  
**SIZE**  
adjusts the sub picture size.  
**STILL**  
freezes motion of the sub picture.  
**POSITION**  
relocates the sub picture in clockwise direction.  
**SCAN**  
switches on or off the programme scan mode through 12 sub pictures.
- 20. STILL**  
freezes motion of the picture.
- COLOURED BUTTONS :** These buttons are used for teletext (only TELETEXT models) or programme edit.

### Battery installation

The remote control handset is powered by two AA type batteries. To load the batteries, turn the remote control handset over and open the battery compartment. Install two batteries as indicated by the polarity symbols (+ and -) marked inside the compartment.

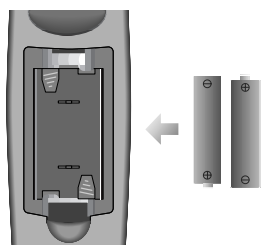

**Note :** To avoid damage from possible battery leakage, remove the batteries if you do not plan to use the remote control handset for an extended period of time.

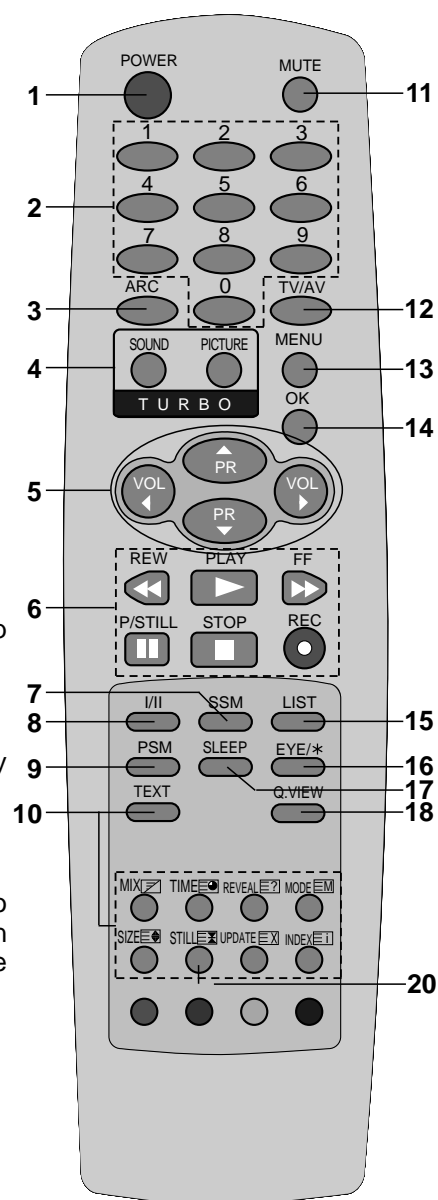

(Without PIP)

# Location and function of controls

## Front panel

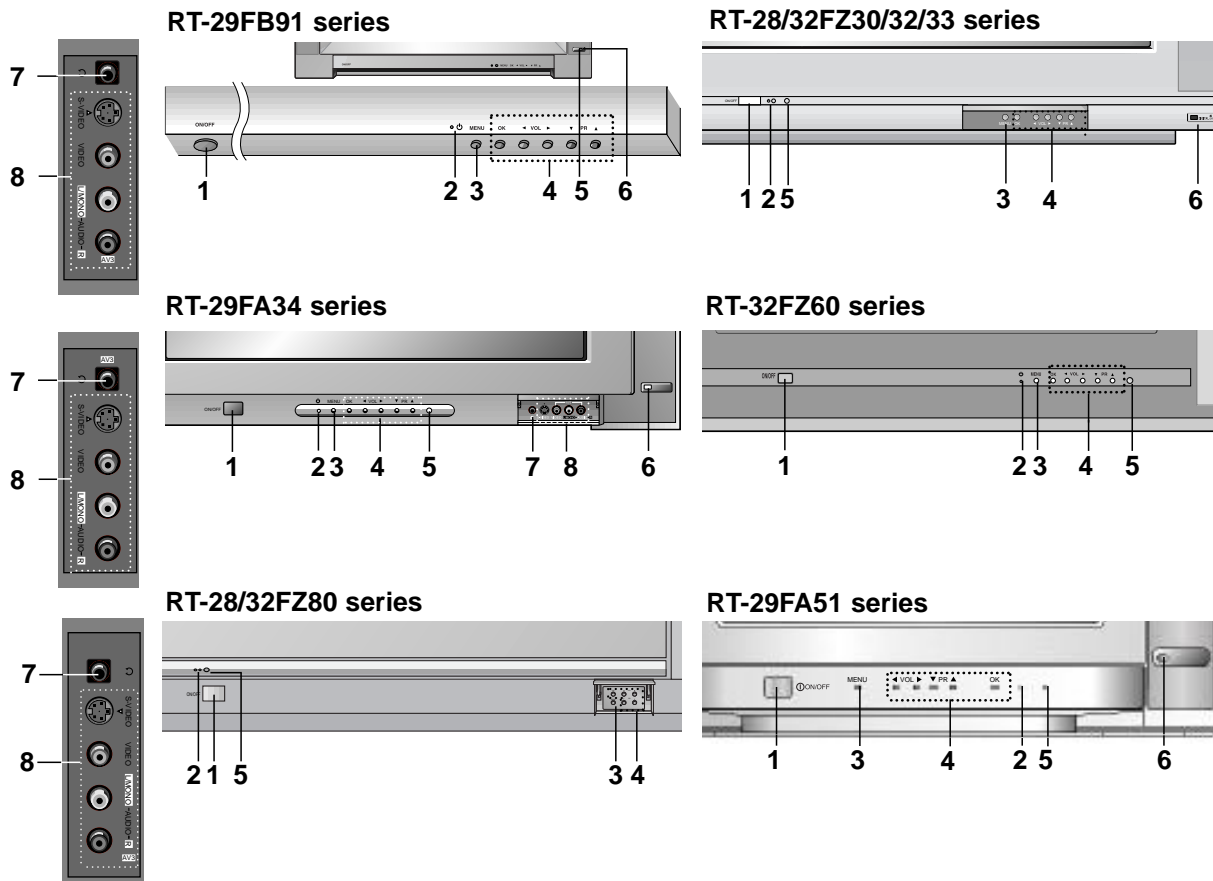

1. **MAIN POWER (ON/OFF)**  
switches the set on or off.
2. **POWER/STANDBY INDICATOR**  
illuminates brightly when the set is in standby mode.  
dims when the set is switched on.
3. **MENU**  
selects a menu.
4. **OK**  
accepts your selection or displays the current mode.  
◀ / ▶ **(Volume Down/Up)**  
adjusts the volume.  
adjusts menu settings.  
▲ / ▼ **(Programme Up/Down)**  
selects a programme or a menu item.  
switches the set on from standby.
5. **REMOTE CONTROL SENSOR**
6. **EYE (option)**  
adjusts picture according to the surrounding conditions.
7. **HEADPHONE SOCKET (option)**  
Connect the headphone plug to this socket.
8. **AUDIO/VIDEO IN SOCKETS (AV3)**  
Connect the audio/video out sockets of external equipment to these sockets.  
**S-VIDEO/AUDIO IN SOCKETS (S-VIDEO)**  
Connect the S-VIDEO out socket of an external equipment to the **S-VIDEO** socket.  
Connect the audio out sockets of the external equipment to the audio sockets as in **AV3**.

---

# Basic operation

---

## On and off

1. Press the main power button to switch the set on.
2. If the set is in standby mode, press the **POWER**, **▲ / ▼**, **TV/AV** or **NUMBER** buttons on the remote control handset to switch it on fully.
3. Press the **POWER** button on the remote control handset.  
The set reverts to standby mode.
4. Press the main power button again to switch the set off.

**Note :** If, while the set is switched on, the mains plug is disconnected the set will switch to standby or power on when the mains plug is replaced in the mains power socket.

## Programme selection

You can select a programme number with the **▲ / ▼** or **NUMBER** buttons.

## Volume adjustment

Press the **◀ / ▶** button to adjust the volume.

## Quick view

Press the **Q.VIEW** button to view the last programme you were watching.

**Note :** This function works only when **Favourite programme** is set to **Off**. Otherwise each press of this button will select a stored favourite programme.

## Mute function

Press the **MUTE** button. The sound is switched off and the display  appears.

You can cancel it by pressing the **MUTE**, **◀ / ▶**, **SSM**, **I/II**, **TURBO SOUND** button.

## Auto Demonstration

To review all the menus programmed in the set, press the **OK** button of the panel control for about 10 seconds. To stop auto demonstration, press any button of the set or **POWER** button of the remote control.

## On screen language selection (option)

The menu can be displayed on the screen in your desired language. First select your language.

1. Press the **MENU** button and then **▲ / ▼** button to select the Special menu.
2. Press the **▶** button and then **▲ / ▼** button to select **Language**.
3. Press the **▶** button and then **▲ / ▼** button to select your desired language.  
All the on screen displays will appear in the selected language. Press the **OK** or **◀** button to select the Special menu.
4. Repeatedly press the **MENU** button to return to normal TV viewing.

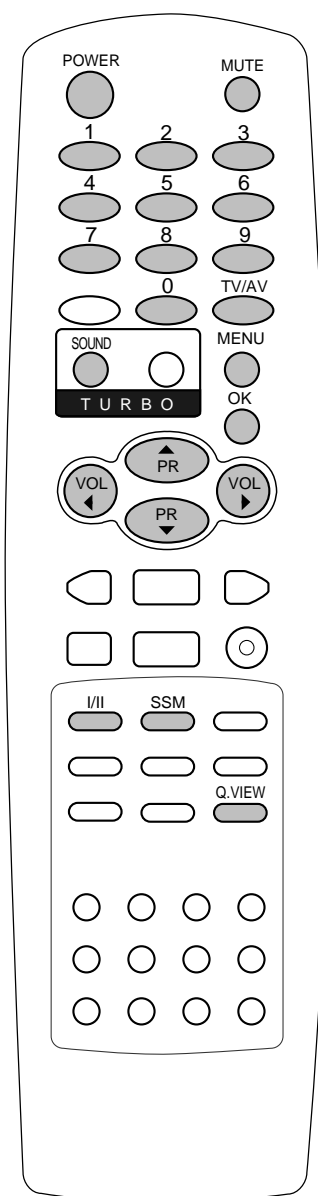

# On screen menus

The dialogue between you and your set takes place on screen with an operator menu. The buttons required for the operating steps are also displayed.

## Menu selection

1. Press the **MENU** button and then **▲ / ▼** button to display each menu.
2. Press the **▶** button and then **▲ / ▼** button to select a menu item.
3. Press the **▶** button to display the sub menu or the pull-down menu.
4. Change the setting of an item in the sub or pull-down menu with **◀ / ▶** or **▲ / ▼**.  
You can move to the higher level menu by pressing the **OK** or **◀** button and to move to the lower level menu by pressing the **▶** button.

### Note :

- a. In the teletext mode, menus are not displayed.
- b. In some models, the **Normal/Turbo search** will not display, only the **Start** will display in the **Auto programme** menu.
- c. On some models, the **Language** will not display.

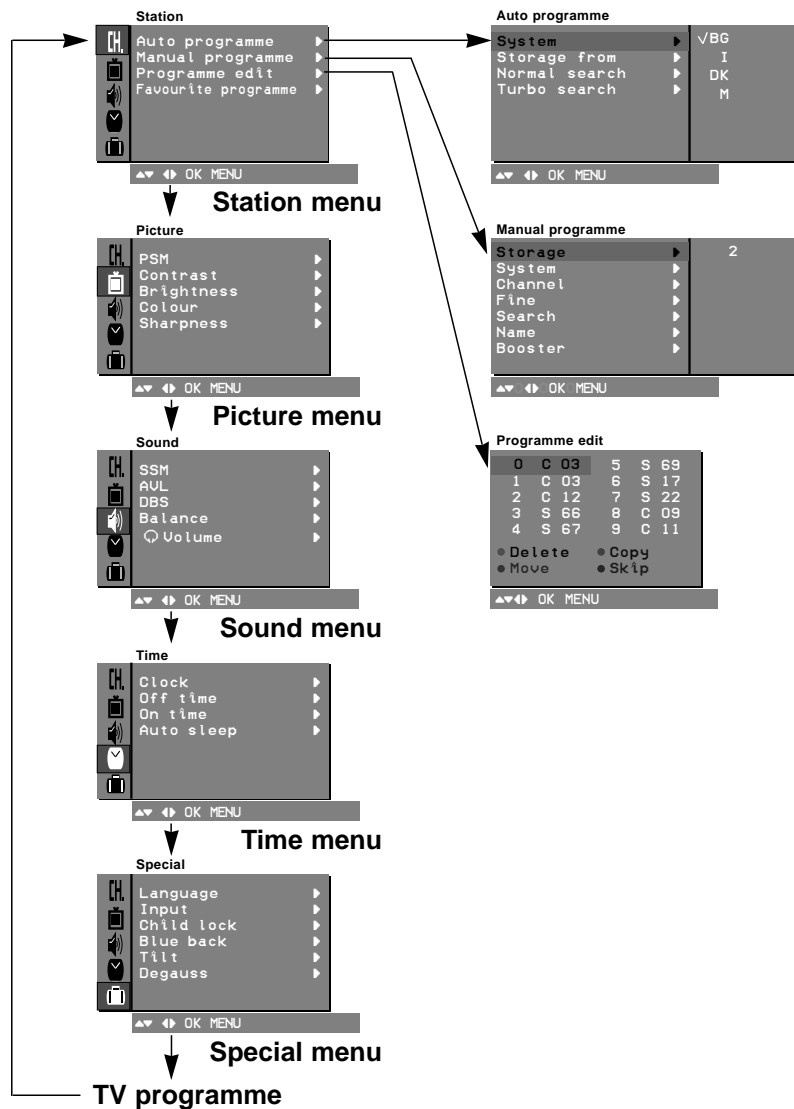
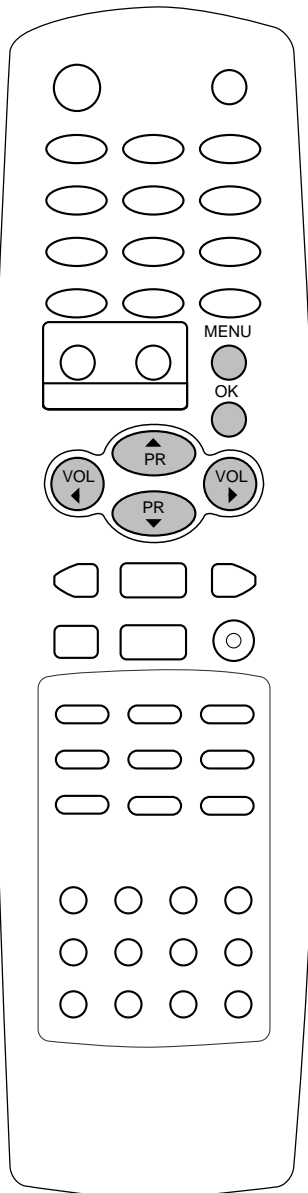



# Setting up TV stations

Up to 100 TV stations can be stored by programme numbers (0 to 99). Once you have preset the stations, you will be able to use the ▲ / ▼ or NUMBER buttons to scan the stations you programmed. Stations can be tuned using automatic or manual modes.

**Note :** In some models up to 200 TV stations can be stored.

## Auto programme tuning

All stations that can be received are stored by this method. It is recommended that you use auto programme during installation of this set.

1. Press the **MENU** button and then ▲ / ▼ button to select the **Station** menu.
2. Press the ► button and then ▲ / ▼ button to select **Auto programme**.
3. Press the ► button to display the **Auto programme** menu.



4. Press the ► button. Select a TV system with the ▲ / ▼ button on the **System** pull-down menu;
  - BG** : (Asia/New Zealand/M.East/Africa/Australia)
  - I** : (Hong Kong/South Africa)
  - DK** : (East Europe/China/Africa/CIS)
  - M** : (USA/Korea/Philippines) (option)
5. Press the ◀ button.
6. Press the ▲ / ▼ button to select **Storage from**.
7. Press the ► button. Select the beginning programme number with the ◀ / ► button or NUMBER buttons on the **Storage from** pull-down menu. Any number under 10 is entered with a numeric '0' (or '00') in front of it, i.e. '05' (or '005') for 5.
8. Press the **OK** button.
9. Press the ▲ / ▼ button to select **Normal** or **Turbo search**.

**Option:** In some models, you can only select **Start**.

### Note :

- a. **Turbo search** is faster than **Normal search** and in some models, these searches will automatically store all receivable stations.
  - b. If the programmed station has poor quality sound, select the system again in the **Manual programme** menu.
10. Press the ► button to begin auto programming. All receivable stations are stored.

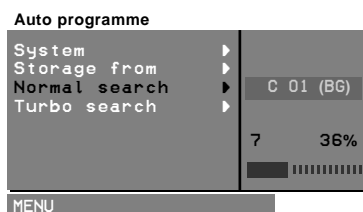

(Normal search)

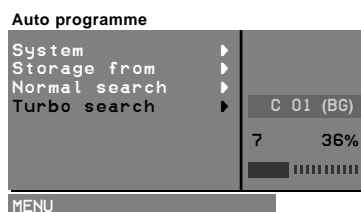

(Turbo search)

To stop auto programming, press the **MENU** button.

When auto programming is completed, the **Programme edit** menu appears on the screen. See the 'Programme edit' section to edit the stored programme.

11. Repeatedly press the **MENU** button to return to normal TV viewing.

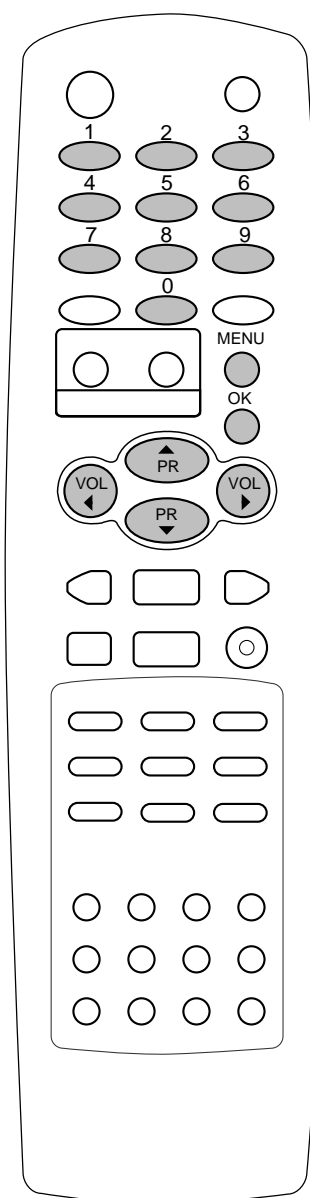

# Setting up TV stations

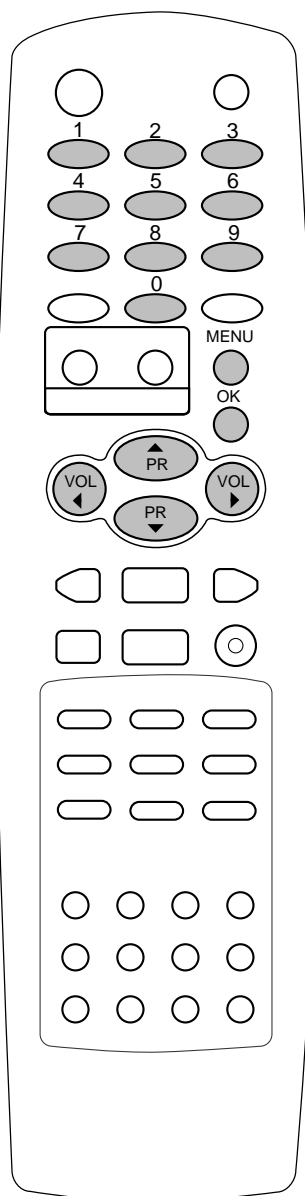
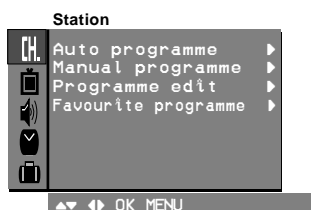

## Manual programme tuning

Manual programme lets you manually tune and arrange the stations in whatever order you desire. Also you can assign a station name with five characters to each programme number.

1. Press the **MENU** button and then **▲ / ▼** button to select the **Station** menu.
2. Press the **▶** button and then **▲ / ▼** button to select **Manual programme**.
3. Press the **▶** button to display the **Manual programme** menu.

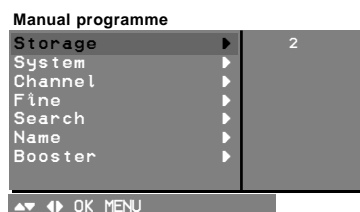

4. Press the **▲ / ▼** button to select **Storage**.
5. Press the **▶** button to select the programme number. Select the desired programme number (0 to 99) with the **◀ / ▶** button or **NUMBER** buttons on the **Storage** pull-down menu. Any number under 10 is entered with a numeric **'0'** (or **'00'**) in front of it, i.e. **'05'** (or **'005'**) for 5.
6. Press the **◀** button.
7. Press the **▲ / ▼** button to select **System**.
8. Press the **▶** button. Select a TV system with the **▲ / ▼** button on the **System** pull-down menu;
  - BG** : (Asia/New Zealand/M.East/Africa/Australia)
  - I** : (Hong Kong/South Africa)
  - DK** : (East Europe/China/Africa/CIS)
  - M** : (USA/Korea/Philippines) (option)
9. Press the **OK** or **◀** button.
10. Press the **▲ / ▼** button to select **Channel**.
11. Press the **▶** button. Press the **▲ / ▼** button to select **V/UHF** or **Cable** on the **Channel** pull-down menu. If possible, select the channel number directly with the number buttons. Any number under 10 is entered with a numeric **'0'** (or **'00'**) in front of it, i.e. **'05'** (or **'005'**) for 5.
12. Press the **OK** or **◀** button.
13. Press the **▲ / ▼** button to select **Search**.
14. Press the **▶** button. Press the **◀ / ▶** button to commence searching on the **Search** pull-down menu. If a station is found the search will stop.
15. Press the **OK** button to store it. The display **Stored** will appear.

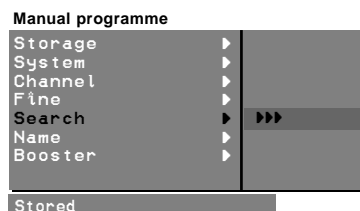

16. To store another station, repeat steps 4 to 15.
17. Repeatedly press the **MENU** button to return to normal TV viewing.

---

# Setting up TV stations

---

## Assigning a station name

1. Repeat the 'Manual programme tuning' steps 1 to 3.
2. Press the ▲ / ▼ button to select **Name**.
3. Press the ► button on the **Name** pull-down menu.
4. Press the ▲ button. You can use a blank, +, -, the numeric 0 to 9 and the alphabet A to Z.

With the ▼ button you can select in the opposite direction.

5. Select the position by pressing the ◀ / ▶ button and then make your choice of the second character, and so on.
6. Press the **OK** button.
7. Repeatedly press the **MENU** button to return to normal TV viewing.



## Booster (option)

In some models, **Booster** is an optional function. Only a set with **Booster** can perform this function.

If the reception is poor at the fringe area of TV signal, select **Booster** to **On**. When the picture condition is good, do not select **Booster** to **On**.

1. Repeat the 'Manual programme tuning' steps 1 to 3.
2. Press the ▲ / ▼ button to select **Booster**.
3. Press the ► button.
4. Press the ▲ / ▼ button to select **On** or **Off** on the **Booster** pull-down menu.
5. Press the **OK** button.
6. Repeatedly press the **MENU** button to return to normal TV viewing.

## Fine tuning

Normally fine tuning is only necessary if reception is poor.

1. Repeat the 'Manual programme tuning' steps 1 to 3.
2. Press the ▲ / ▼ button to select **Fine**.
3. Press the ► button.

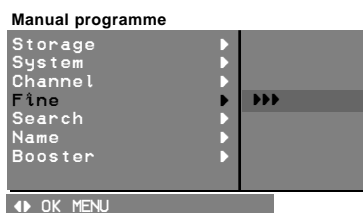

4. Press the ◀ / ▶ button to fine tune for the best picture and sound on the **Fine** pull-down menu.
5. Press the **OK** button.
6. Repeatedly press the **MENU** button to return to normal TV viewing.

The finely tuned programme will be indicated by a yellow number during programme selection.

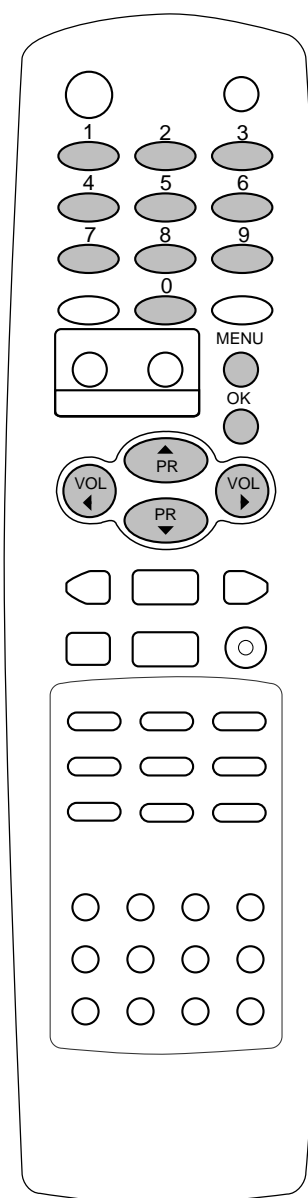

# Setting up TV stations

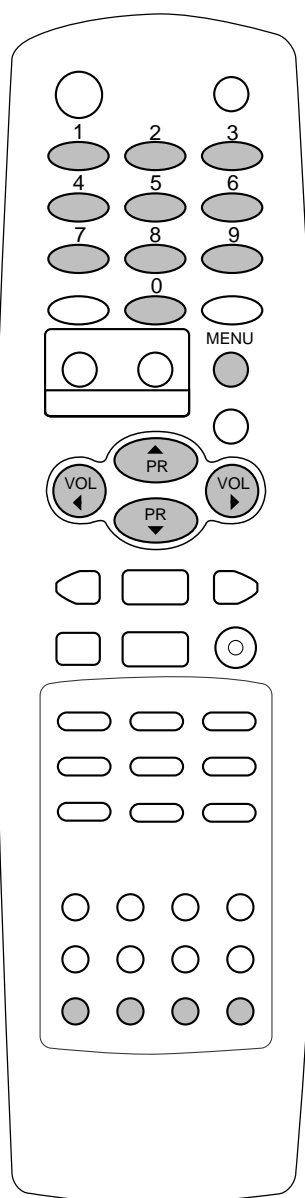

## Programme edit

This function enables you to delete or skip the stored programmes. Also you can move some stations to other programme numbers or insert a blank station data into the selected programme number.

1. Press the **MENU** button and then **▲ / ▼** button to select the Station menu.
2. Press the **▶** button and then **▲ / ▼** button to select **Programme edit**.
3. Press the **▶** button to display the **Programme edit** menu.

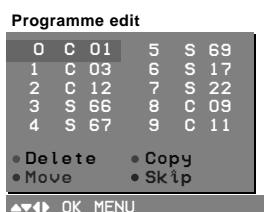

### Deleting a programme

1. Select a programme to be deleted with the **▲ / ▼** or **◀ / ▶** button.
2. Press the **RED** button twice.  
The selected programme is deleted, all the following programmes are shifted up one position.

### Copying a programme

1. Select a programme to be copied with the **▲ / ▼** or **◀ / ▶** button.
2. Press the **GREEN** button.  
All the following programmes are shifted down one position.

### Moving a programme

1. Select a programme to be moved with the **▲ / ▼** or **◀ / ▶** button.
2. Press the **YELLOW** button.
3. Move the programme to the desired programme number with the **▲ / ▼** or **◀ / ▶** button.
4. Press the **YELLOW** button again to release this function.

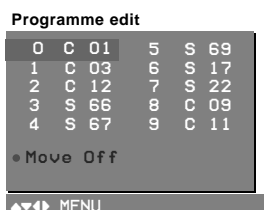

### Skipping a programme number

1. Select a programme number to be skipped with the **▲ / ▼** or **◀ / ▶** button.
2. Press the **BLUE** button. The skipped programme turns to blue.
3. Press the **BLUE** button again to release the skipped programme. When a programme number is skipped it means that you will be unable to select it using the **▲ / ▼** button during normal TV viewing. If you want to select the skipped programme, directly enter the programme number with the **NUMBER** buttons or select it in the programme edit or table menu.

Repeatedly press the **MENU** button to return to normal TV viewing.

# Setting up TV stations

## Favourite programme

This function lets you select your favourite programmes directly.

1. Press the **MENU** button and then **▲ / ▼** button to select the **Station** menu.
2. Press the **▶** button and then **▲ / ▼** button to select **Favourite programme**.
3. Press the **▶** button to display the **Favourite programme** menu.



4. Press the **◀ / ▶** button to select **On** or **Off**.
5. Press the **▲ / ▼** button to select -- -----.
6. Select a desired programme with the **◀ / ▶** button or **NUMBER** buttons. Any number under 10 is entered with a numeric '0' (or '00') in front of it, i.e. '05' (or '005') for 5.
7. To store another programme, repeat steps 5 to 6. You can store up to 8 programmes.
8. Press the **OK** button.
9. Repeatedly press the **MENU** button to return to normal TV viewing.

Repeatedly press the **Q.VIEW** button to select stored favourite programmes.

## Calling the programme table

You can check the programmes stored in the memory by displaying the programme table.

### Displaying programme table

Press the **LIST** button to display the **Programme table** menu. The programme table appears on the screen. One programme table contains ten programmes as below.

Station				
0	C	01	5	S 69
1	C	03	6	S 17
2	C	12	7	S 22
3	S	66	8	C 09
4	S	67	9	C 11

### Note :

- a. You may find some blue programmes. They have been set up to be skipped by auto programming or in the programme edit mode.
- b. Some programmes with the channel number shown in the programme table indicate there is no station name assigned.

### Selecting a programme in the programme table

Select a programme with the **▲ / ▼** or **◀ / ▶** button. Then press the **OK** button. The set switches to the chosen programme number.

### Paging through a programme table

There are 10 programme table pages which contain 100 programmes. Pressing the **▲ / ▼** or **◀ / ▶** button repeatedly turns the pages.

Repeatedly press the **MENU** button to return to normal TV viewing.

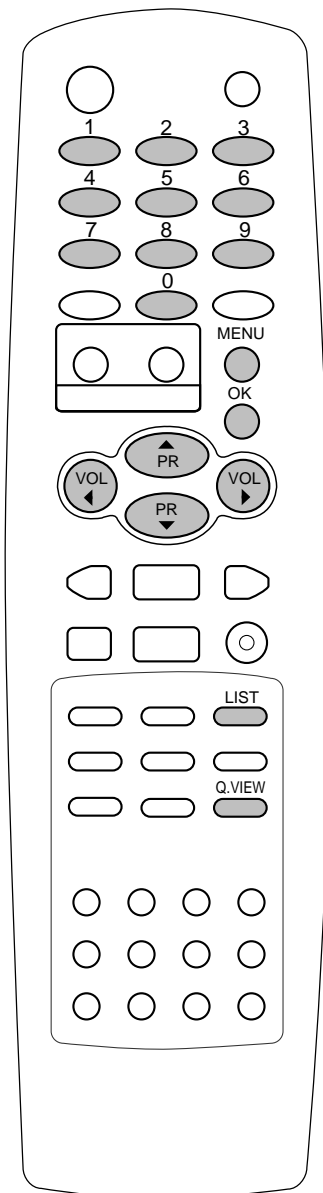

# Picture adjustment



## PSM (Picture Status Memory)

1. Press the **MENU** button and then **▲ / ▼** button to select the Picture menu.
2. Press the **▶** button and then **▲ / ▼** button to select **PSM**.
3. Press the **▶** button and then **▲ / ▼** button to select a picture setting on the **PSM** pull-down menu.



4. Press the **OK** or **◀** button.
5. Repeatedly press the **MENU** button to return to normal TV viewing.

You can also recall a desired picture (**Dynamic, Standard, Mild, Game** or **User**) with **PSM** button on the remote control. The picture **Dynamic, Standard, Mild** and **Game** are programmed for optimum picture reproduction at the factory and cannot be changed.

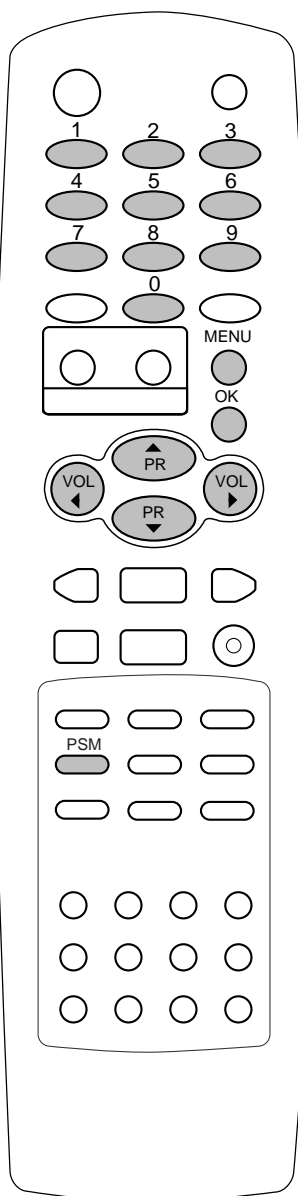

## Picture adjustment

You can adjust picture contrast, brightness, colour intensity, sharpness and tint (NTSC input only) to the levels you prefer.

1. Press the **MENU** button and then **▲ / ▼** button to select the Picture menu.
2. Press the **▶** button and then **▲ / ▼** button to select **Contrast, Brightness, Colour** or **Sharpness**.



3. Press the **▶** button and then **◀ / ▶** button to make appropriate adjustments on the each sub menu.
4. Press the **OK** button to store it for the picture user.



5. Repeatedly press the **MENU** button to return to normal TV viewing.

---

# Picture adjustment

---

## Picture format

You can watch TV in various picture formats; 4:3 and Zoom.  
In some models, you can watch TV in various picture formats; 16:9 (Wide), 14:9, Zoom, Auto and 4:3.  
Repeatedly press the **ARC** button to select your desired picture format.

### 4:3

This picture format is 4 to 3 of general TV.

### 16:9

You can enjoy the cinema (the picture format of 16:9) or general TV programme through the 16:9 mode.

### 14:9 (option)

You can enjoy the picture format of 14:9 or general TV programme through the 14:9 mode. The screen 14:9 is viewed just like that the screen 4:3 is magnified to the upper / lower and left / right. You can move the screen up or down with ▲ / ▼ button.

### Zoom

You can enjoy the cinema in a vast screen through the Zoom mode. The screen 4:3 is magnified to the upper/lower and left/right sides so that the screen 16:9 is full. The bottom and top of the picture may be lost. In some models, You can move the screen up or down with ▲ / ▼ button.)

### Auto (option)

When your TV receives the wide screen signal, it will be automatically changed to the picture format to be sent.

### Note :

- In some models, when you switch the set to standby or off, the **16:9** or **Zoom** picture format is reset to the **4:3**.
- In the 1/2 size sub picture and Programme scan of PIP mode the picture format is not available.

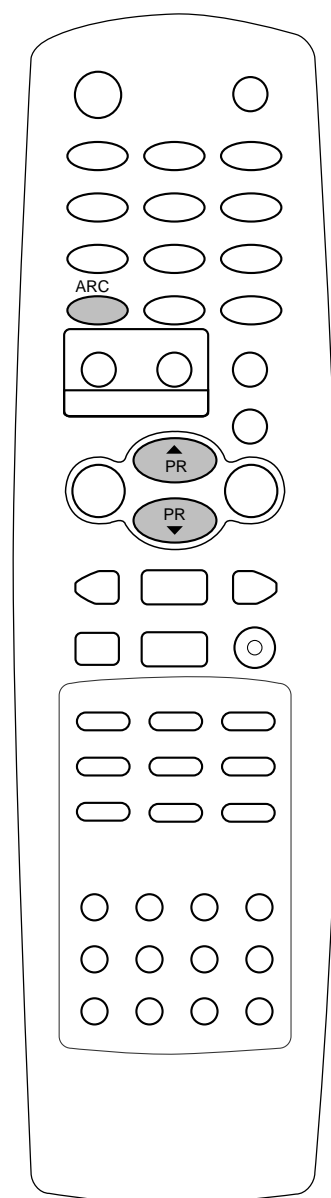

---

# Picture adjustment

---

## Eye (option)

Eye is an optional function. Only a set with eye option can perform this function.

In some models, the set will automatically adjust the picture according to the surrounding conditions. This will enable you to enjoy the most suitable picture according to the surroundings.

Press the **EYE/★** button to switch the eye function on or off.

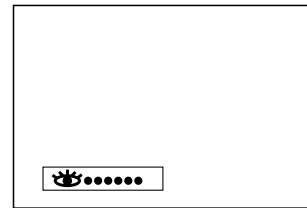
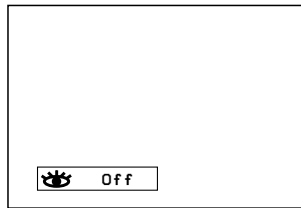

When the eye function is on, the most suitable picture is automatically adjusted according to the surrounding conditions.

At this time the display ●●●●● in green does not appear continuously but the display ●●●●● in yellow appears each time the picture condition changes.

**Note :** If you press the **PSM** or **TURBO PICTURE** button with the eye function, the eye function is automatically switched off.

## Turbo picture selection (option)

When this function is on, the picture will be more brilliant and distinct than normal.

Repeatedly press the **TURBO PICTURE** button to switch on or off.

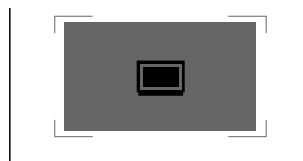

(Turbo Picture off)

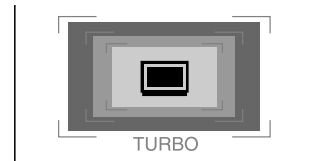

(Turbo Picture on)

**Note :** If you press the **PSM** button with the Turbo picture function, the Turbo picture function is automatically switched off.

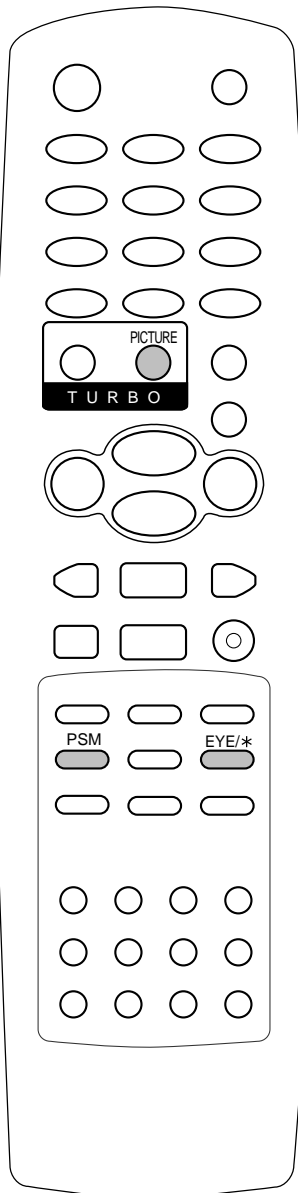



# Sound adjustment

## SSM (Sound Status Memory)

You can select your preferred sound setting; Flat, Music, Movie or Speech and you can also adjust the sound frequency of the equalizer.

1. Press the **MENU** button and then **▲ / ▼** button to select the Sound menu.
2. Press the **▶** button and then **▲ / ▼** button to select **SSM**.
3. Press the **▶** button and then **▲ / ▼** button to select a sound setting on the **SSM** pull-down menu.

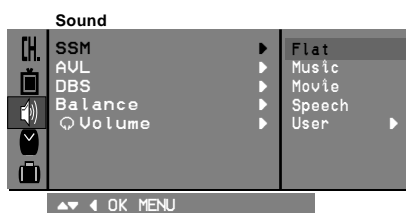
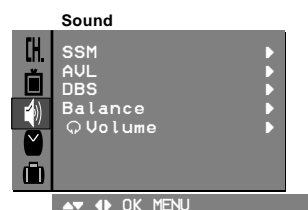

## Sound Frequency Adjustment

- a. Press the **▶** button in **User** to display the **User** sub menu.



- b. Select a sound band by pressing the **◀ / ▶** button.
- c. Select appropriate sound level with the **▲ / ▼** button.
- d. Press the **OK** button to store it for the sound **User**.

Repeatedly press the **MENU** button to return to normal TV viewing.

You can also recall a desired sound (**Flat**, **Music**, **Movie**, **Speech** or **User**) with **SSM** button on the remote control. The sound **Flat**, **Music**, **Movie** and **Speech** are programmed for optimum sound reproduction at the factory and cannot be changed.

**Note :** If you press the **SSM** button after making appropriate adjustment on the **User** sub menu, the display **User** automatically appears even though you have already set a factory preset setting; **Flat**, **Music**, **Movie** or **Speech**.

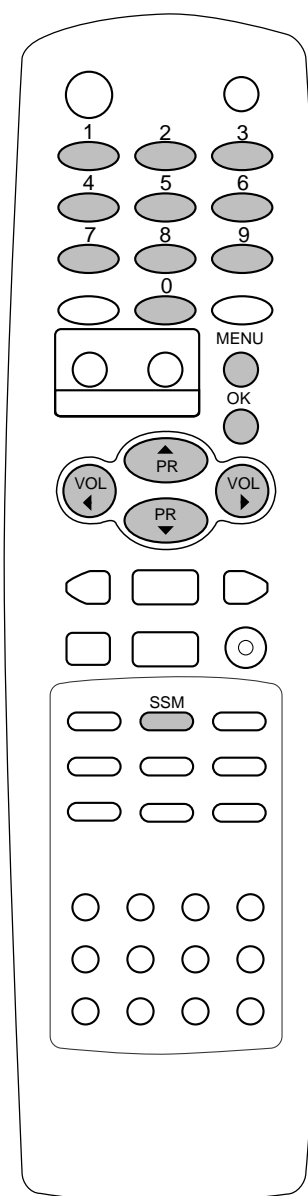

# Sound adjustment

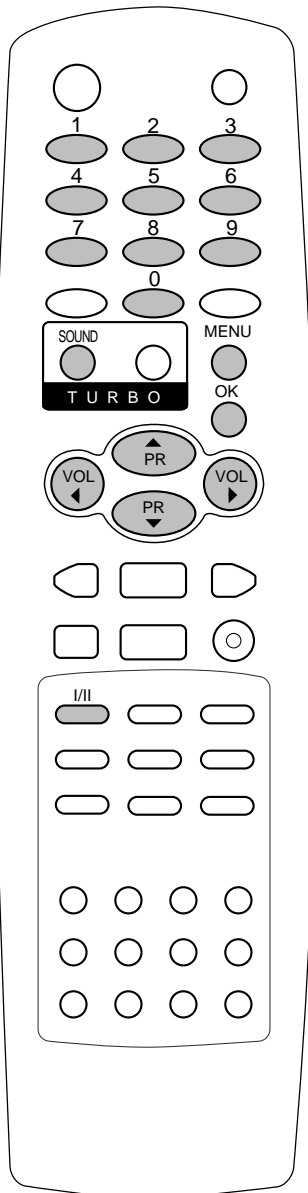
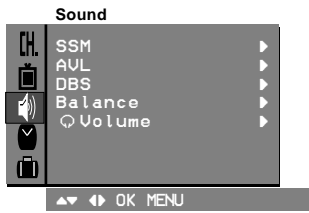

## Sound adjustment

You can adjust balance, AVL (Auto Volume Leveler), DBS or headphone volume/sound. AVL automatically keeps on an equal volume level even if you change programmes. If you switch DBS to on, the set creates a dynamic bass sound. The Turbo sound creates an all around sound as in a concert hall.

1. Press the **MENU** button and then **▲ / ▼** button to select the Sound menu.
2. Press the **▶** button and then **▲ / ▼** button to select the desired sound item; **AVL**, **DBS**, **Balance**, **Volume**.
3. Make desired adjustment with the **◀ / ▶**, **▲ / ▼** or **OK** button on each pull-down menu.

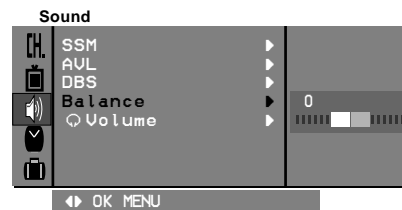

4. Repeatedly press the **MENU** button to return to normal TV viewing.

## Turbo sound selection (option)

When this function is on, the sound will be more emphasized and amplified than normal.

Repeatedly press the **TURBO SOUND** button to switch on or off.

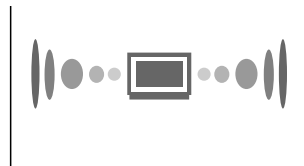

(Turbo Sound off)



(Turbo Sound on)

## Sound output selection

In AV mode, you can select output sound for the left and right loudspeakers.

Repeatedly press the **I/II** button to select the sound output.

**L+R** : Audio signal from audio L input is sent to left loud-speaker and audio signal from audio R input is sent to right loud-speaker.

**L+L** : Audio signal from audio L input is sent to left and right loud-speakers.

**R+R** : Audio signal from audio R input is sent to left and right loud-speakers.

---

# Sound adjustment

---

## Stereo/Dual reception

When a programme is selected, the sound information for the station appears after the programme number and station name disappear.

Broadcast	On Screen Display
Mono	<b>MONO</b>
Stereo	<b>STEREO</b>
Dual	<b>DUAL I</b>

### Mono sound selection

In stereo reception if the stereo signal is weak, you can switch to mono by pressing the **I/II** button twice. In mono reception the depth of sound is improved. To switch back to stereo, press the **I/II** button twice again.

### Language selection for dual language broadcast

If a programme is received in two languages (dual language), you can switch to **DUAL I**, **DUAL II** or **DUAL I+II** by pressing the **I/II** button repeatedly.

**DUAL I** sends the primary broadcast language to the loudspeakers.

**DUAL II** sends the secondary broadcast language to the loudspeakers.

**DUAL I+II** sends a separate language to each loudspeaker.

### NICAM reception (option)

If your set is equipped with the receiver for NICAM reception, the high quality NICAM (Near Instantaneous Commanding Audio Multiplex) digital sound can be received.

Sound output can be selected according to the type of received broadcast as follows by pressing the **I/II** button repeatedly.

1. When NICAM mono is received, you can select **NICAM MONO** or FM MONO.
2. When NICAM stereo is received, you can select **NICAM STEREO** or FM MONO. If the stereo signal is weak, switch to FM mono.
3. When NICAM dual is received, you can select **NICAM DUAL I**, **NICAM DUAL II** or **NICAM DUAL I+II** or **MONO**. When FM mono is selected the display **MONO** appears on the screen.

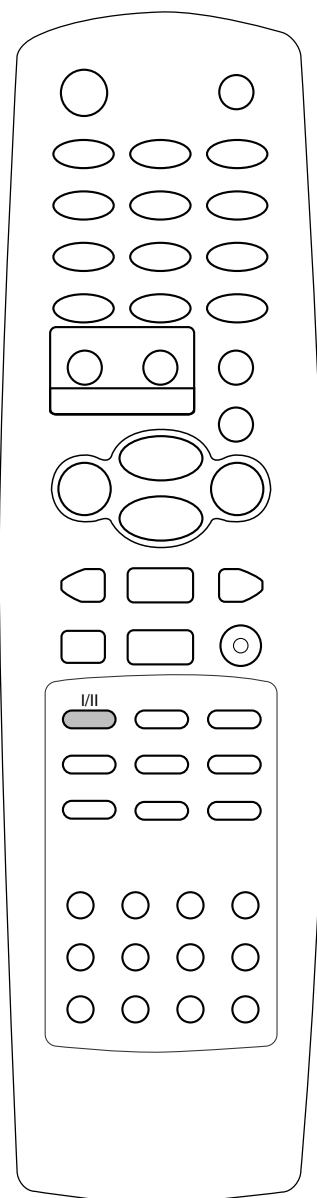

# Time setting

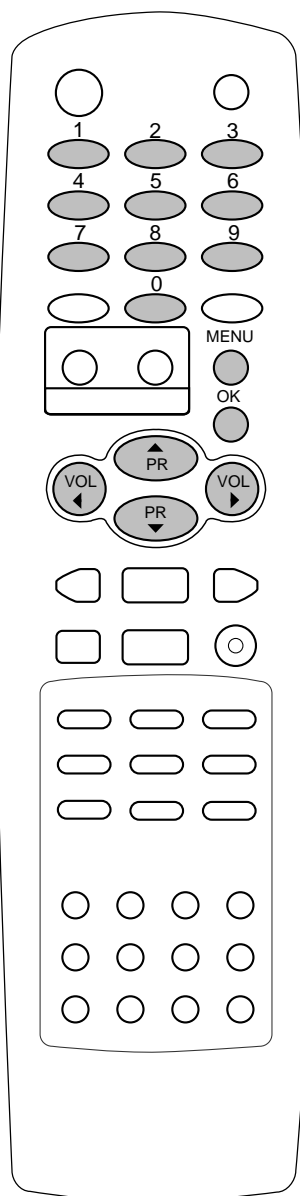
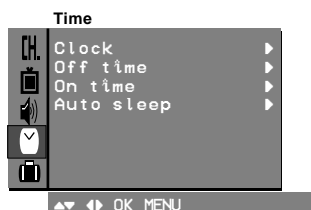

## Setting the clock

1. Press the **MENU** button and then  $\blacktriangle / \blacktriangledown$  button to select the Time menu.
2. Press the  $\blacktriangleright$  button and then  $\blacktriangle / \blacktriangledown$  button to select **Clock**.
3. Press the  $\blacktriangleright$  button and then  $\blacktriangle / \blacktriangledown$  button to adjust the hour.



4. Press the  $\blacktriangleright$  button and then  $\blacktriangle / \blacktriangledown$  button to adjust the minute.
5. Press the **OK** button.
6. Repeatedly press the **MENU** button to return to normal TV viewing.

## Setting the On/Off timer

By using this function, the set automatically switches on or off at a preset time. You must set the time correctly before using on/off time function.

1. Press the **MENU** button and then  $\blacktriangle / \blacktriangledown$  button to select the Time menu.
2. Press the  $\blacktriangleright$  button and then  $\blacktriangle / \blacktriangledown$  button to select **Off time/On time**.
3. Press the  $\blacktriangleright$  button and then  $\blacktriangle / \blacktriangledown$  button to adjust the hour.



4. Press the  $\blacktriangleright$  button and then  $\blacktriangle / \blacktriangledown$  button to adjust the minute.
5. **Only On time function;** Press the  $\blacktriangleright$  button and then  $\blacktriangle / \blacktriangledown$  button to adjust programme number and volume level.
6. Press the **OK** button.
7. Repeatedly press the **MENU** button to return to normal TV viewing.

### Note :

- a. **On time** works only in standby mode.
- b. To view the remaining on/off time, select the Time menu.
- c. When you switch the main power off, the **Clock** is reset.

## Auto sleep

If you select **On** on the **Auto sleep** pull-down menu, the set will automatically switch itself to standby mode approximately ten minutes after a TV station stops broadcasting.

1. Press the **MENU** button and then  $\blacktriangle / \blacktriangledown$  button to select the Time menu.
2. Press the  $\blacktriangleright$  button and then  $\blacktriangle / \blacktriangledown$  button to select **Auto sleep**.
3. Press the  $\blacktriangleright$  button and then  $\blacktriangle / \blacktriangledown$  button to select **On** or **Off** on the **Auto sleep** pull-down menu.
4. Repeatedly press the **MENU** button to return to normal TV viewing.

## Other functions

### TV and AV modes

Inputs can be set for TV or AV mode. AV mode is used when a video cassette recorder (VCR), or other equipment is connected to the set.

**Note :** When a VCR is connected via the aerial socket the set is used in TV mode. See the 'Connection of external equipment' section.

1. Press the **MENU** button and then **▲ / ▼** button to select the Special menu.
2. Press the **▶** button and then **▲ / ▼** button to select **Input**.
3. Press the **▶** button and then **▲ / ▼** button to select **TV, AV1, AV2, AV3** or **COMPONENT** on the **Input** pull-down menu.

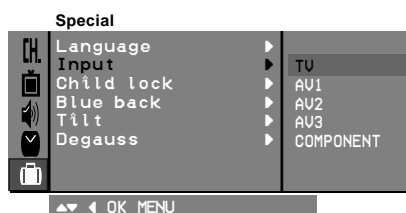

AV1 : VCR connected to the Euro scart socket or **AV1** sockets on the set.

AV2 : VCR connected to the **AV2** sockets on the set.

AV3 : VCR connected to the **AV3** sockets on the set.

COMPONENT : DVD Player connected to the **COMPONENT** sockets on the set

4. Repeatedly press the **MENU** button to return to normal TV viewing.

Alternatively you can select the TV or AV mode by pressing the **TV/AV** button.

In AV mode, to return to TV mode, press the **▲ / ▼** or **NUMBER** buttons.

### Auto AV switching (option)

If your VCR outputs an AV switching voltage when connected to the Euro scart socket, the set will switch to **AV1** mode automatically. But if you want to keep on watching TV mode, press the **▲ / ▼** or **NUMBER** buttons.

Press the **TV/AV** button to return to AV modes.

### Child lock

The TV can be set so that the remote control handset is needed to control it. This feature can be used to prevent unauthorized viewing.

1. Press the **MENU** button and then **▲ / ▼** button to select the Special menu.
2. Press the **▶** button and then **▲ / ▼** button to select **Child lock**.
3. Press the **▶** button and then **▲ / ▼** button to select **On** or **Off** on the **Child lock** pull-down menu.
4. Repeatedly press the **MENU** button to return to normal TV viewing.

With the lock on, the display **Child lock on** appears on the screen if any button on the front panel is pressed while viewing the TV.

**Note :** The display **Child lock on** will not appear on the screen if any button on the front panel is pressed while displaying the menus.

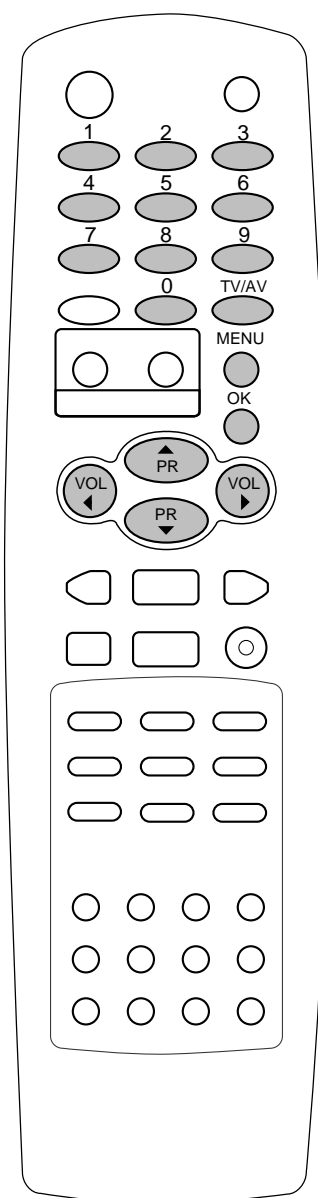

---

## Other functions

---

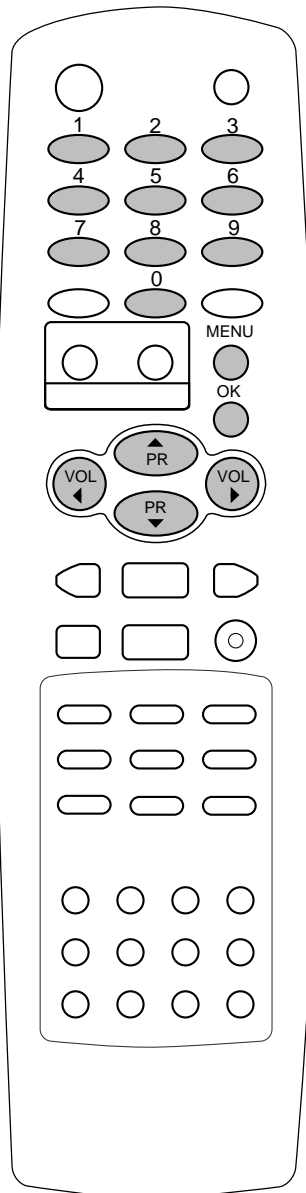

### Blue back (option)

If you select **On** on the **Blue back** pull-down menu, the blue background appears on the screen when there is no or poor signal.

1. Press the **MENU** button and then **▲ / ▼** button to select the Special menu.
2. Press the **▶** button and then **▲ / ▼** button to select **Blue back**.
3. Press the **▶** button and then **▲ / ▼** button to select **On** or **Off** on the **Blue back** pull-down menu.
4. Repeatedly press the **MENU** button to return to normal TV viewing.

#### Note :

- a. The blue background automatically appears on the screen when there is no signal in AV mode.
- b. In the Twin picture mode, PIP, Component mode, the blue background doesn't appear on the screen.

### Tilt

The TV picture may tilt to the left or right if the TV set moves to another position. This function can be used to compensate the tilt.

1. Press the **MENU** button and then **▲ / ▼** button to select the Special menu.
2. Press the **▶** button and then **▲ / ▼** button to select **Tilt**.
3. Press the **▶** button and then **◀ / ▶** button to adjust the tilt on the **Tilt** pull-down menu.
4. Repeatedly press the **MENU** button to return to normal TV viewing.

### Degaussing (option)

Owing to the super large used in the set. The colour purity of the picture may be affected by other magnetic influences such as speakers. Stripes may appear on the screen or there may be colour patches. You can restore high colour quality by operating the Degaussing function.

1. Press the **MENU** button and then **▲ / ▼** button to select the Special menu.
2. Press the **▶** button and then **▲ / ▼** button to select **Degauss**.
3. Press the **▶** button and then **▲ / ▼** button to select **On** on the **Degauss** pull-down menu. After the degauss function works, **On** mode switches to **Off** mode.
4. Repeatedly press the **MENU** button to return to normal TV viewing.

**Note :** If you cannot adjust the screen condition by degaussing, try it again after about 4 minutes.

### Sleep timer

You don't have to remember to switch the set off before you go to sleep. The sleep timer automatically switches the set to standby after the preset time elapses.

Press the **SLEEP** button to select the number of minutes. The display **⏻** will appear on the screen, followed by **10, 20, 30, 60, 90, 120, 180** and **240**. The timer begins to count down from the number of minutes selected.

#### Note :

- a. To view the remaining sleep time, press the **SLEEP** button once.
- b. To cancel the sleep time, repeatedly press the **SLEEP** button until the display **⏻** appears.
- c. When you switch the set off, the set releases the preset sleep time.

---

## PIP operation (option)

---

### Option :

PIP is an optional function, so that only the set with PIP function can operate.

PIP (Picture in Picture) displays a picture within a picture.

PIP function is not available in Component mode.

### On and off

Press the **PIP** button to switch on the sub picture.  
press this button again to switch it off.

### Input mode selection for sub picture

Press the **INPUT** button to select the input mode for the sub picture.

Each time this button is pressed, each input mode for the sub picture is displayed as shown below.

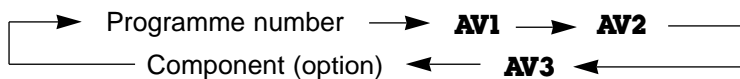

### Swapping between main and sub pictures

Press the **SWAP** button to exchange the main and sub pictures.

**Note :** When the main picture is TV or AV modes, the swapping is available.

### Programme selection for sub picture

Press the **PR +/-** buttons to select a programme for the sub picture.  
(In some models, the sub picture programme selection is available when the sub picture is TV mode.)

### Sub picture size

Repeatedly press the **SIZE** button to select the desired sub picture size. The sub picture appears as below.

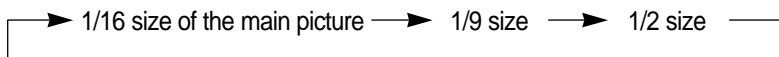

**Note :** When the sub picture size is 1/2 of the main picture, the picture quality might get poor.

### Sub picture freeze

Press the **STILL** button to freeze motion of the sub picture.  
Press this button again to restore motion.

### Sub picture position change

Press the **POSITION** button repeatedly until desired position is achieved. The sub picture moves clockwise.

### Programme scan

This function enables you to search all the stored stations in 12 sub pictures mode only and see your desired station by exchanging the main and sub pictures.

Press the **SCAN** button to select 12 sub pictures.

Only the selected 12 sub pictures search all the stored stations.

Press the **SCAN** button again to switch off these sub pictures.

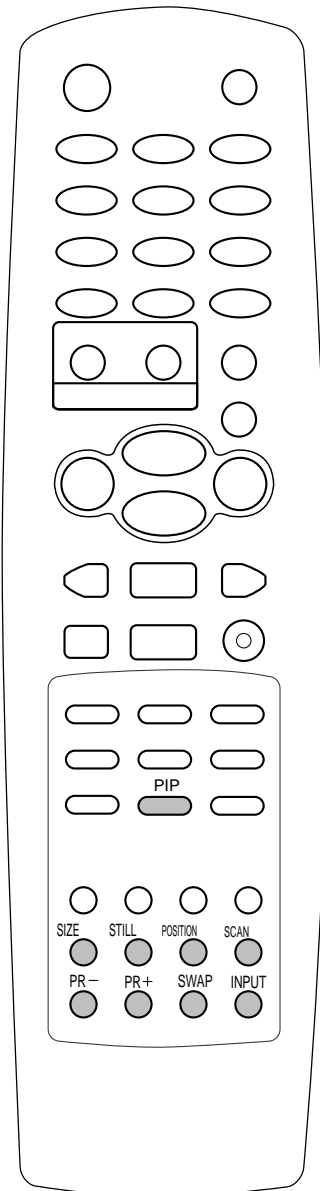

---

## Teletext (option)

---

Teletext (or TOP text) is an optional function, therefore only a set with the teletext system can receive the teletext broadcast.

Teletext is a free service broadcast by most TV stations which gives up-to-the-minute information on news, weather, television programmes, share prices and many other topics.

The teletext decoder of this TV can support the SIMPLE, TOP and FASTEXT systems. SIMPLE (standard teletext) consists of a number of pages which are selected by directly entering the corresponding page number. TOP and FASTEXT are more modern methods allowing quick and easy selection of teletext information.

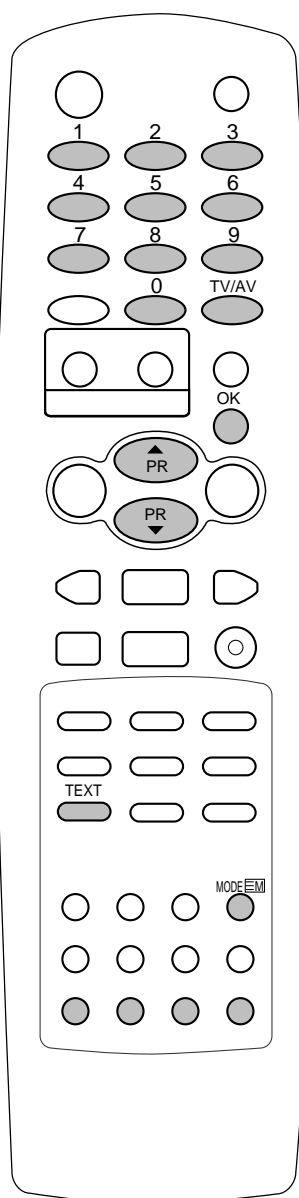

### Switch on/off

Press the **TEXT** button to switch to teletext. The initial page or last page appears on the screen.

Two page numbers, TV station name, date and time are displayed on the screen headline. The first page number indicates your selection, while the second shows the current page displayed.

Press the **TEXT** button to switch off teletext. The previous mode reappears.

### SIMPLE text

#### Page selection

1. Enter the desired page number as a three digit number with the **NUMBER** buttons. If during selection you press a wrong number, you must complete the three digit number and then re-enter the correct page number.
2. The **▲ / ▼** button can be used to select the preceding or following page.

#### Programming a colour button in LIST mode

If the TV is in SIMPLE text, TOP text or FASTEXT mode, press the **MODE** button to switch to LIST mode.

Four teletext page numbers of your choice can be colour coded and easily selected by pressing the corresponding coloured button on the remote control handset.

1. Press a coloured button.
2. Using the **NUMBER** buttons, select the page you wish to programme.
3. Press the **OK** button. Then the selected page is stored as the selected page number by blinking once. From now on, you can select this page with the same coloured button.
4. The three other coloured buttons are programmed in the same way.



---

# Teletext (option)

---

## TOP text (option)

The user guide displays four fields-red, green, yellow and blue at the bottom of the screen. The yellow field denotes the next group and the blue field indicates the next block.

### Block / group / page selection

1. With the blue button you can progress from block to block.
2. Use the yellow button to proceed to the next group with automatic overflow to the next block.
3. With the green button you can proceed to the next existing page with automatic overflow to the next group. Alternatively the ▲ button can be used.
4. The red button permits to return to previous selection. Alternatively the ▼ button can be used.

### Direct page selection

Corresponding to the SIMPLE teletext mode, you can select a page by entering it as a three digit number using the NUMBER buttons in TOP mode.

## FASTEXT

The teletext pages are colour coded along the bottom of the screen and are selected by pressing the corresponding coloured button.

### Page selection

1. Press the  button to select the index page.
2. You can select the pages which are colour coded along the bottom line with the same coloured buttons.
3. Corresponding to the SIMPLE teletext mode, you can select a page by entering its three digit page number with the NUMBER buttons in FASTEXT mode.
4. The ▲ / ▼ button can be used to select the preceding or following page.

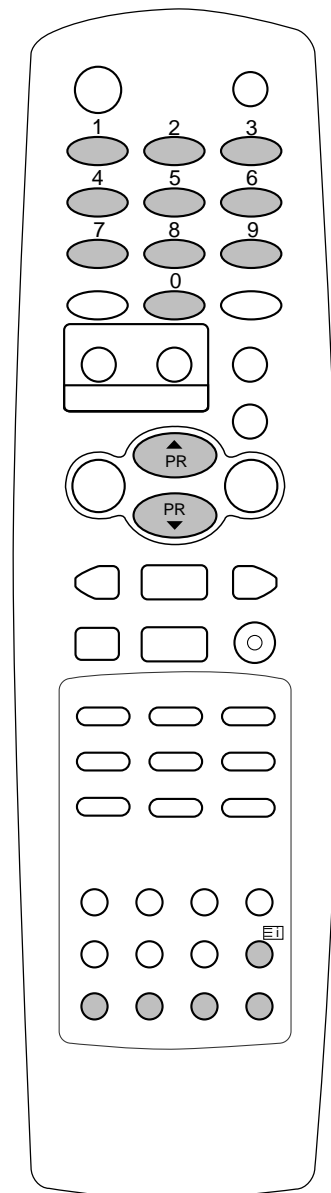

---

# Teletext (option)

---

## Special teletext functions

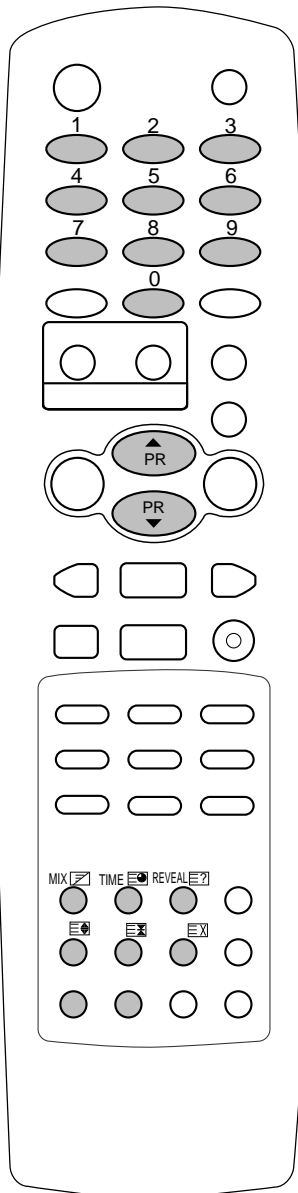

### REVEAL

Press this button to display concealed information, such as solutions of riddles or puzzles.

Press this button again to remove the information from the display.



### SIZE

Selects double height text.



Press this button to enlarge the top half of the page.

Press this button again to enlarge the bottom half of the page.

Press this button again to return to the normal display.



### UPDATE

Displays the TV picture on the screen while waiting for the new teletext page. The display  will appear at the top left hand corner of the screen. When the updated page is available then display  will change to the page number.

Press this button to view the updated teletext page.



### HOLD

Stops the automatic page change which will occur if a teletext page consists of 2 or more sub pages. The number of sub pages and the sub page displayed is, usually, shown on the screen below the time. When this button is pressed the stop symbol is displayed at the top left-hand corner of the screen and the automatic page change is inhibited.

To continue press this button again.



### MIX

Displays the teletext pages superimposed on the TV picture.

To switch the TV picture off press this button again.



### TIME

When viewing a TV programme, press this button to display the time at the top right hand corner of the screen. Press this button again to remove the display. In the teletext mode, press this button to select a sub page number. The sub page number is displayed at the bottom of the screen. To hold or change the sub page, press the RED / GREEN, ▲ / ▼ or NUMBER buttons.

Press this button again to exit this function.

---

## Connection of external equipment

---

You can connect additional equipment, such as VCRs, camcorders etc. to your set.

Here shown may be somewhat different from your set.

### Aerial socket

1. Connect the RF out socket of the VCR to the aerial socket on the back of the set.
2. Connect the aerial cable to the RF aerial in socket of the VCR.
3. Store the VCR channel on a desired programme number using the 'Manual programme tuning' section.
4. Select the programme number where the VCR channel is stored.
5. Press the **PLAY** button on the VCR.

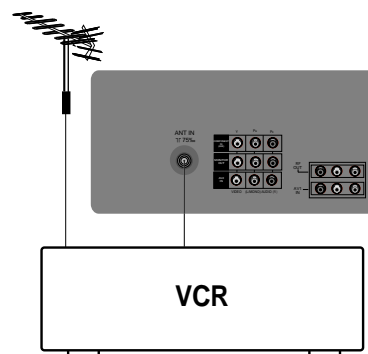

### Euro scart socket (option)

1. Connect the Euro scart socket of the VCR to the Euro scart socket of the set.
2. Press the **PLAY** button on the VCR.  
If your VCR outputs a switching voltage connect to Euro scart socket, the set will switch to **AV1** mode automatically. But if you want to keep on watching TV mode, press the **▲ / ▼** or **NUMBER** buttons.

Otherwise press the **TV/AV** button on the remote control handset to select **AV1**. The VCR playback picture appears on the screen.

You can also record programmes received by the TV on video tape.

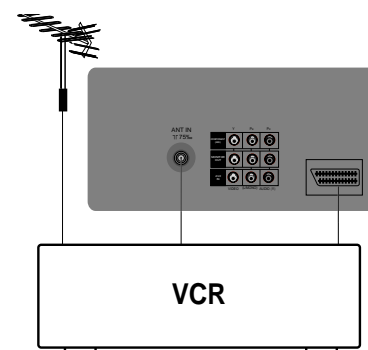

### Audio/Video in sockets (option)

1. Connect the audio/video out sockets of the VCR to audio/video in sockets of the set.
2. If the VCR is connected to the AV sockets on the set, press the **TV/AV** button to select **AV1**, **AV2** or **AV3**.
3. Press the **PLAY** button on the VCR.  
The VCR playback picture appears on the screen.

You can also record programmes received by the TV on video tape via audio/video out sockets.

**Note :** If you have a mono VCR, connect the audio cable from the VCR to the **AUDIO L/MONO** socket of the set.

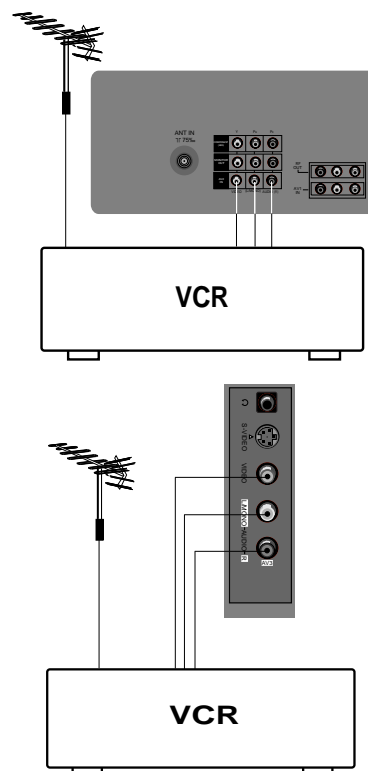

---

## Connection of external equipment

---

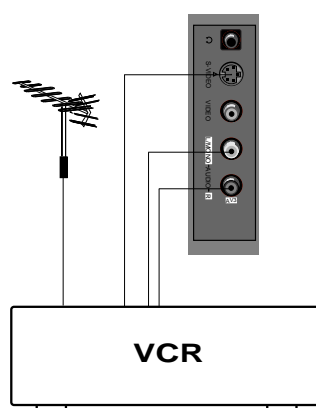

### S-Video/Audio in sockets (S-AV) (option)

When connecting the S-Video socket of the VCR to the **S-VIDEO** socket of the set, the picture quality will be further improved.

1. Connect the S-Video socket of the VCR to the **S-VIDEO** socket of the set.
2. Connect the audio cable from the VCR to the **AUDIO** sockets on the side panel of the set.
3. Select **AV3** by pressing the **TV/AV** button repeatedly.
4. Press the **PLAY** button on the VCR.  
The VCR playback picture appears on the screen.

**Note :** If both **S-VIDEO** and **VIDEO** sockets have been connected to the VCR simultaneously, only the **S-VIDEO** can be received.

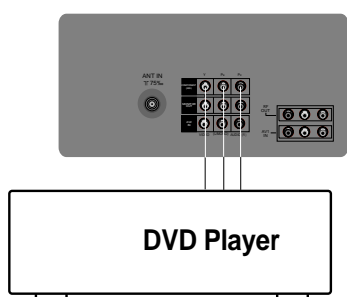

### Component in sockets (option)

1. Connect the COMPONENT video output sockets (Y Cb Cr, Y Pb Pr or Y B-Y R-Y) of the DVD player to the COMPONENT INPUT sockets (Y P<sub>B</sub> P<sub>R</sub>) on the set.
2. Connect the audio cable from the DVD player to AUDIO IN sockets of **AV2**.
3. Press the **TV/AV** button to select **COMPONENT**.
4. Press the **PLAY** button on the DVD player.  
The COMPONENT playback picture appears on the screen.

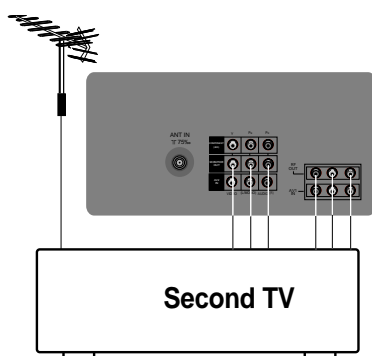

### Monitor out sockets

Connect the audio/video in sockets of the other TV or monitor or VCR to **MONITOR OUT** sockets of the set.

### RF out sockets

Connect the audio/video in sockets of the other TV or monitor or VCR to **RF OUT** sockets of the set.

---

## Connection of external equipment

---

### Headphone socket (option)

Insert the headphone plug to the headphone socket of the set. You can listen to the sound through the headphone and the TV's speakers. To adjust the headphone volume, press the ◀/▶ button on the **Volume** pull-down menu. See the 'Sound adjustment' section.

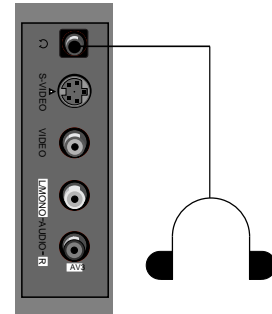
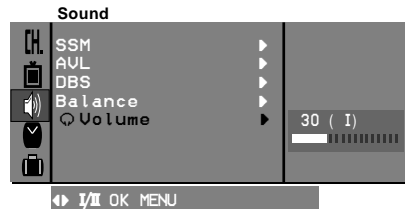

If you press the **MUTE** button, only the sound from the TV's speakers are switched off.

When a programme is received in dual language, you can select a language (**DUAL I**, **DUAL II** or **DUAL I+II**) for the sound from the headphone regardless of that from the TV's speakers. On the **Volume** pull-down menu, press the I/II button to select the desired language; **I**, **II** or **I II**.

At this time if the set is in AV mode, the I/II button selects output sound; **L R**, **L L** or **R R**, in turn.

---

## Note

---

# Troubleshooting check list

## Symptoms

No picture, no sound

Sound OK, poor picture

Picture OK, poor sound

Picture blurred

Lines or streaks in picture

Poor reception on some channels

No colour

Poor colour

Remote control does not work

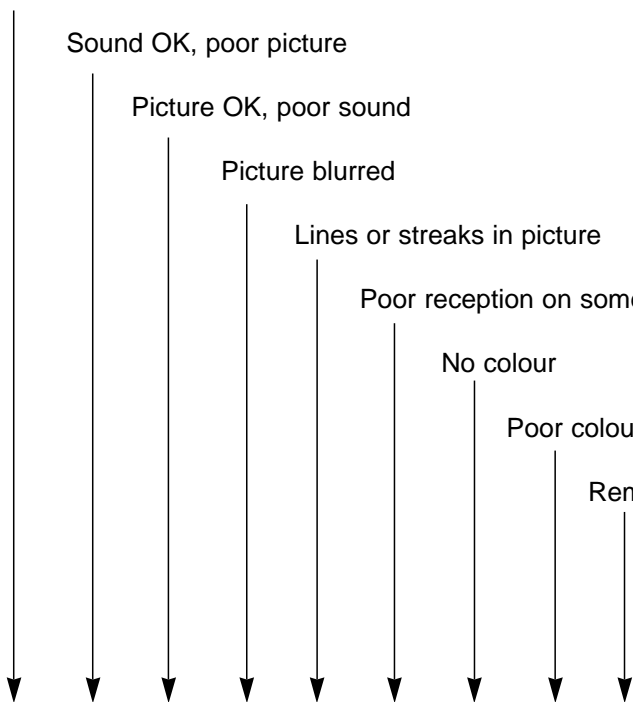
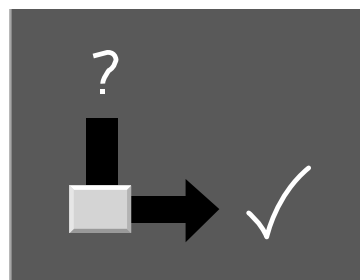

**Check these items and try to adjust these**

The mains plug-(plugged in and switched on)

Is the TV switched on

Try another channel (weak signal)

Check aerial (plugged into TV?)

Check aerial (broken lead?)

Check aerial

Check for local interference

Adjust contrast

Adjust brightness

Adjust colour

Adjust volume

Check the batteries in remote control

Check Audio/Video sockets (VCR only)

