



CAR CD/MP3/WMA Receiver
OWNER'S MANUAL
MODEL : LAC6700R

Please read this instruction booklet carefully and completely before installing, operating or adjusting this product.



Safety note



CAUTION
RISK OF ELECTRIC SHOCK
DO NOT OPEN



CAUTION : TO REDUCE THE RISK OF ELECTRIC SHOCK DO NOT SPLIT COVER(OR BACK) NO USER SERVICEABLE PARTS INSIDE. REFER SERVICING TO QUALIFIED SERVICE PERSONNEL.



The lightning flash with the arrowhead symbol, within an equilateral triangle is intended to alert the user about the presence of uninsulated dangerous voltage within the product's enclosure that may be of sufficient magnitude to constitute a risk of electric shock.



The exclamation point within an equilateral triangle is intended to alert the user to the presence of important operating and maintenance (servicing) instructions in the literature accompanying the appliance.



Always operate the vehicle in a safe manner. Do not become distracted by the vehicle while driving, and always be fully aware of all driving condition. Do not change settings, or any functions. Pull over in a safe and legal manner before attempting such operations.



Do not use for many hours at extremely low or high temperature. (-10~60°C)



To reduce the risk of electric shock, do not remove the cover or back of this product. There are no user-serviceable parts inside. Refer servicing to qualified service personnel.



To reduce the risk of fire or electric shock, do not expose this product to dripping or splashing water, rain, or moisture.



The temperature of unit's outside can be extremely high, please use the unit after proper installation in your vehicle.

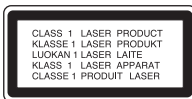

CAUTION : This product uses a Laser System.

To ensure proper use of this product, please read this owner's manual carefully and retain it for future reference. Should the unit require maintenance, contact an authorized service center.

Performing controls, adjustments, or carrying out procedures other than those specified herein may result in hazardous radiation exposure.

To prevent direct exposure to laser beam, do not try to open the enclosure.

Visible laser radiation when open. DO NOT STARE INTO BEAM.

Safety note



- A defective or soiled disc inserted into unit can cause sound to drop out during playback.
- Handle the disc by holding its inner and outer edges.
- Do not touch the surface of the unlabeled side of the disc.



Do not stick paper or tape etc. on the surface.



Do not expose the disc to direct sunlight or excessive heat.



This unit cannot play 8cm disc (use 12cm disc only).



- Clean the disc before playback. Wipe the disc from the center outward with a cleaning cloth.
- Never use solvents such as benzine or alcohol to clean the disc.

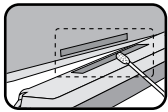

Periodically wipe the contacts on the back of the control panel with a cotton swab moistened with alcohol.



Disposal of your old appliance

1. When this crossed-out wheeled bin symbol is attached to a product, it means the product is covered by the European Directive 2002/96/EC.
2. All electrical and electronic products should be disposed of separately from the municipal waste stream via designated collection facilities appointed by the government or the local authorities.
3. The correct disposal of your old appliance will help prevent potential negative consequences for the environment and human health.
4. For more detailed information about disposal of your old appliance, please contact your city office, waste disposal service or the shop where you purchased the product.



This product is manufactured to comply with Directive 2005/83/EEC(ANNEX I , 3.2.9), 72/245/EEC and 2006/95/EEC.



Table of contents

Safety note	2-3
Table of contents	4
Before use	5
Control panel	6
Remote control	7
Installation	8
Connection diagram	9
Connection	10
Basic operation	11-14
Radio operation	15
RDS operation	16
CD/MP3/WMA operation	17-18
USB operation	19
Troubleshooting	20
Specifications	21

A section whose title has one of the following symbols is applicable only to the disc represented by the symbol.

- CD** Audio CDs
- MP3** MP3 files
- WMA** WMA files

Before use

Detaching the control panel

You can detach the control panel when leaving the car. When detaching or attaching the control panel, be careful not to damage the connectors on the back of the control panel and on the panel holder.

1. Press the “▲” button to unlock the control panel.
2. Push the control panel to left
3. Pull the control panel out of the unit.
4. Put the detached control panel into the protective case.

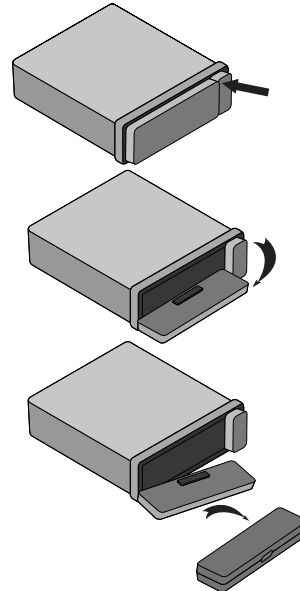

Attachable control panel

- 1 Attach part **A** of the control panel to part **B** of the unit.
- 2 Attach part **C** of the control panel to part **D** of the unit while pushing the control panel to left.
- 3 Close the front panel.

Caution

- When detaching or attaching the control panel, do not press the display or control buttons.
- The control buttons may not work properly if the control panel is not attached properly. If this occurs, gently press the control panel.
- Do not leave the control panel in any area exposed to high temperatures or direct sunlight.
- Do not drop the control panel or otherwise subject it to strong impact.
- Do not allow such volatile agents as benzine, thinner, or insecticides to come into contact with the surface of the control panel.
- Do not try to disassemble the control panel.

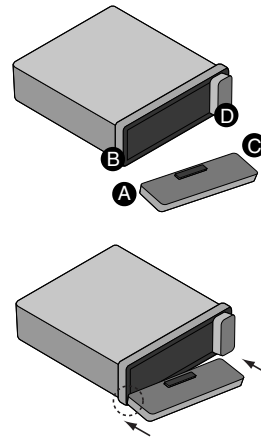



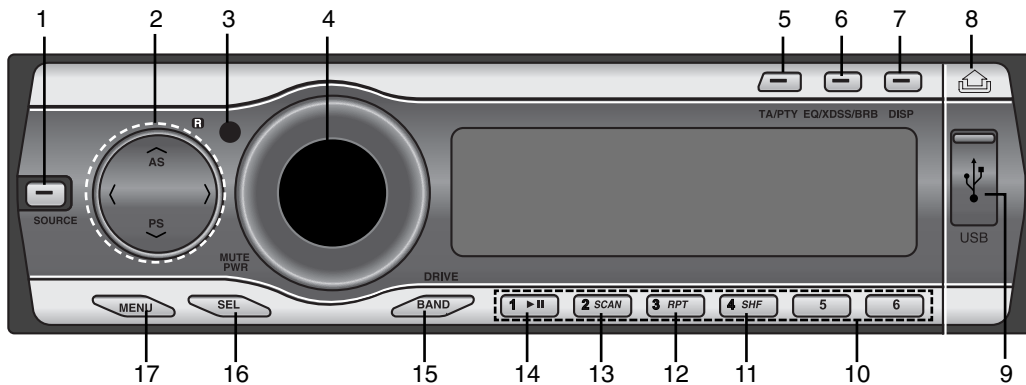















Control Panel



- | | |
|--|---|
| <p>1 [SOURCE]</p> <p>2 • Skip / Search </></p> <p>• Seek/ Tune </></p> <p>• Auto Store [A/AS]</p> <p>• Preset Scan [V/PS]</p> <p>• MP3 Track +10/-10 \wedge/\vee MP3 WMA</p> <p>• Folder Up/Down \wedge/\vee MP3 WMA</p> <p>3 Remote Sensor</p> <p>4 • Volume</p> <p>• [MUTE]</p> <p>• Power [PWR]</p> <p>5 • Traffic Announcement [TA]</p> <p>• Programme Type [PTY]</p> <p>6 • Equalizer [EQ]</p> <p>• Extreme Dynamic Sound System [XDSS]</p> <p>• Bass Reverb Blaster [BRB]</p> <p>7 Display [DISP]</p> <p>8 Release/Eject </p> | <p>9 USB Slot</p> <p>10 Preset Station [1-6]</p> <p>11 Shuffle [SHF]</p> <p>12 Repeat [RPT]</p> <p>13 Intro Scan [SCAN]</p> <p>14 Play/Pause ▶/ </p> <p>15 • [BAND]</p> <p>• [DRIVE]</p> <p>16 Select [SEL]</p> <p>17 [MENU]</p> |
|--|---|

Remote control

- 1 Power [POWER] / Mute 
- 2 Select [MENU/SEL]
- 3 Source [SRC]
- 4 Play / Pause 
- 5 Intro Scan [SCAN]
- 6 Shuffle [SHF]
- 7 • MP3 Track +10  
- Folder Up   
- 8 • CD Skip / Search 
- Seek / Tune 
- 9 • [BAND]
- DRIVE [DRV]
- 10 Volume Up  / Down 
- 11 Number [#]
- 12 Repeat [RPT]
- 13 Number [0-9]
- 14 • CD Skip / Search 
- Seek / Tune 
- 15 Display [DISP.]
- 16 • MP3 Track -10  
- Folder Down   

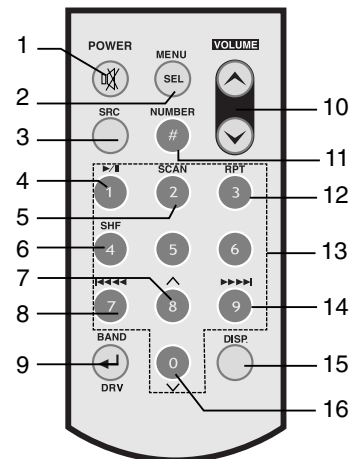

Battery installation

- 1 Remove the battery holder with a sharp product like a ball point pen.
- 2 Install the battery on the battery holder.
- 3 Install the battery holder back into its original position.

Note

- Use only one CR2025 (3V) lithium battery.
- Remove the battery if the remote control is not used for a long period of time.
- Do not leave the product in a hot or humid place.
- Do not handle the battery with metallic tools.
- Do not store the battery with metallic materials.

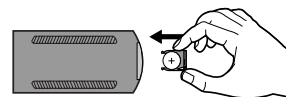
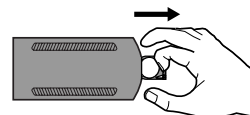
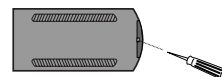

Installation

Basic Installation

Before installing, make sure that the ignition-switch is set to OFF and remove the terminal of the car battery to avoid short-circuiting.

- 1 Remove the existing receiver unit.
- 2 Make the necessary connections.
- 3 Install the installation sleeve.
- 4 Install the unit into the installation sleeve.

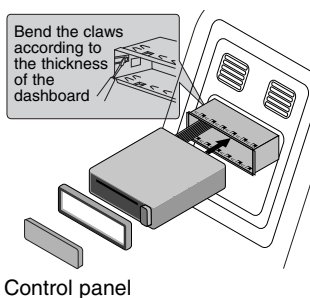

Removing the existing receiver unit.

If there is already an installation sleeve for the receiver unit in the dashboard, it must be removed.

- 1 Remove the rear support from the unit.
- 2 Remove the control panel and trim ring from the unit.
- 3 Insert the lever **A** into the hole on one side of the unit. Perform the same operation on the other side and pull the unit out from the mounting sleeve.

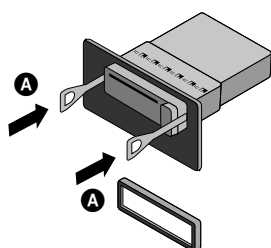

ISO-DIN Installation

- 1 Slide the unit into the ISO-DIN frame.
- 2 Fit screws removed from the old unit.
- 3 Slide the unit and frame into the dash opening.
- 4 Install the dash panel or adapter plate.
- 5 Install the trim ring to the unit.
- 6 Install the control panel to the unit.

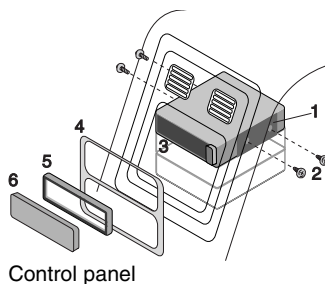

Connection diagram

Before connecting, make sure that the ignition switch is set to OFF, and remove the battery ⊖ terminal to avoid short circuits.

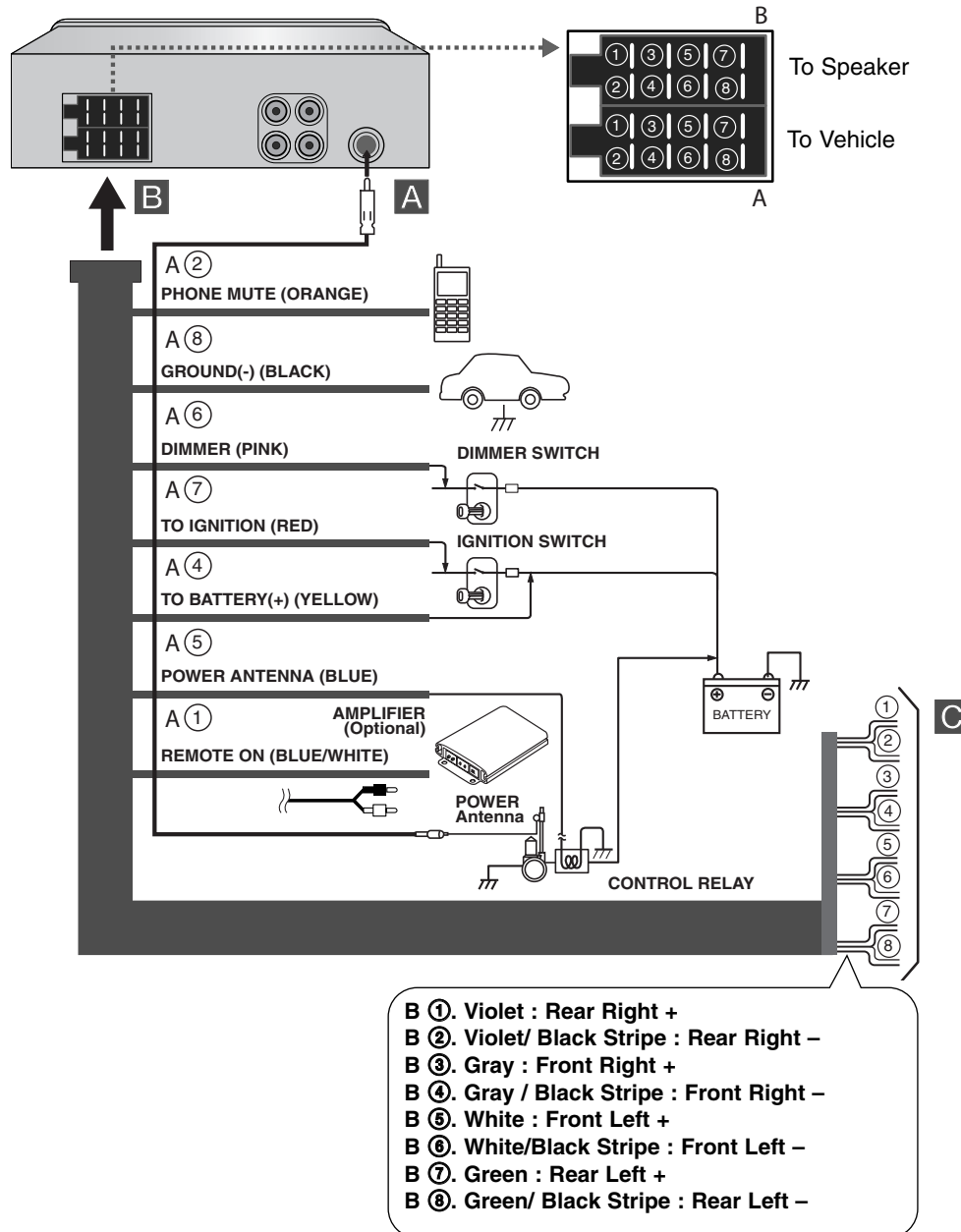

Connection

C Speaker Connections

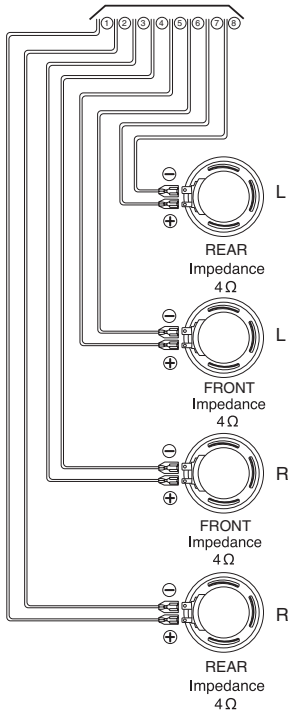

A From antenna

B To the wiring of the vehicle colors of leads.

- **BLACK** : This lead is for the ground connection.
- **ORANGE** : This lead is for the phone line connection.
- **PINK** : This lead is for the dimmer line connection.
- **RED** : This lead is for connection to the power supply terminal when the ignition switch is set to ACC.
- **YELLOW** : This lead is for connection to the battery (back-up) terminal from which power is always supplied.
- **BLUE** : This lead is for the power antenna connection.
- **BLUE/WHITE** : This lead is for the remote amplifier on connection.

Connecting to Auxiliary Equipment (Optional)

Connect the **AUDIO OUTPUT** jack of this unit to the **AUDIO INPUT** jack of the Auxiliary Equipment.

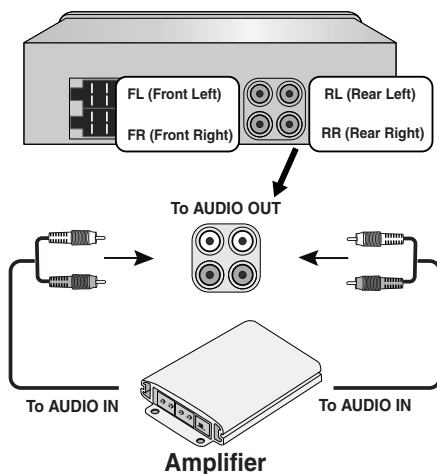

Basic operation



Turning the unit on

Press **MUTE/PWR** (**POWER**/ ) on the remote control) or any other button.

Note

When you insert the CD in the CD slot, the unit turns on.

Turning the unit off

Press and hold **MUTE/PWR** (**POWER**/ ) on the remote control).

Insert a disc

- 1 Press  to open the control panel.
- 2 Draws the disc, and starts playback automatically.

Eject a disc

Press  to open the control panel. The disc automatically ejects from the loading slot.

When the disc is ejected by pressing  during playback, it will be loaded automatically after 10 seconds unless you pull out disc from the unit.

Selecting a source



Press **SOURCE** repeatedly to select a source.

The indicator lights up in the following order. TUNER → CD → USB → TUNER...

Note

You cannot select a source if is not ready.

Adjusting the volume

Rotate **MUTE/PWR** (Press **VOLUME**   on the remote control) to adjust the sound level.

Note

When you turn the unit off, the current volume level is automatically memorized. Whenever you turn the unit back on, it will operate at the memorized volume level.

Mute

- 1 Press **MUTE/PWR** (**POWER**/ ) on the remote control) to cut the sound.
- 2 To cancel it, press again.

Checking the clock

You can see the clock pressing **DISP** (**DISP.** on the remote control).

Basic operation

Changing the general settings

- 1 Press **MENU** (Press and hold **MENU/SEL** on remote control) so that one of menu items appears.
- 2 Press **MENU** (**MENU/SEL** on remote control) to scroll between menus.
AF ON → REG ON → TA ALARM → PI SOUND → DEMO ON → BEEP 2ND
- 3 Rotate **MUTE/PWR** clockwise or unclockwise to select one of the settings specified belows.
(Press **VOLUME** ^ v on the remote control.)
- 4 Press and hold **MENU** (**MENU/SEL** on remote control) to finish the setting.

● AF(Alternative frequency) ON / OFF

When the reception quality drops, the tuner automatically changes to another station in the network, broadcasting a better reception quality, using the PI and AF codes.

AF ON :

wherever you drive, you can continue to listen to the same program without interruptions.

AF OFF :

Only station name will be displayed. In case of poor reception no alternative station can be used.

● REG (Region) ON / OFF

REG ON :

The unit switches to another station, within the same network, broadcasting the same program when the receiving signals from the current station become weak.

REG OFF :

The unit switches to another station, within the same network when the receiving signals from the current station become weak. (This mode, the program may differ from the one currently received.)

● TA(Traffic Announcement) ALARM / SEEK

TA ALARM :

When a newly tuned station has no TP information for 5 seconds, a double beep sound is output.

TA SEEK :

When the newly tuned station does not receive TP information for 5 seconds, the receiver retunes to the next station which has the same PI as the last station, but has the TP information.

● PI (Programme Identification) SOUND / MUTE

PI SOUND :

If the sound of a station with different PI is heard intermittently, the receiver mutes the sound after 1 second.

PI MUTE :

If the sound of a station with different PI is heard intermittently, the receiver mutes the sound right now.

Basic operation



- **DEMO ON / OFF**

You can change the initial indication on the display to information name (function name, EQ name, etc...) while listen to a source.

- **DEMO ON**

- Displays information name while listening to source.

- **DEMO OFF**

- Cancels the function.

- **BEEP 2ND / ALL**

Sets the beep sound every time a button is pressed.

- **BEEP 2ND**

- The beep is generated when a key is long pressed. (1 sec)

- **BEEP ALL**

- The beep is generated when any key is pressed.

Using the EQ (Equalizer)

Press **EQ/XDSS/BRB** repeatedly. The indicator lights up in the following order.

Pop → Classic → Rock → Jazz → Vocal → Salsa → Samba → User1 → User2 → Off

- Pop : Optimized for R&B, Soul and Country music.
- Classic : Optimized for orchestral music.
- Rock : Optimized for Hard Rock and Heavy Metal music.
- Jazz : Sweet sound with soft feeling.
- Vocal : Powerful realism with strong sound quality.
- Salsa : Reproduces salsa music acoustics.
- Samba : Reproduces samba music acoustics.
- User1 : Use the menu to set the sound level you want.
- User2 : Use the menu to set the sound level you want.

You can adjust each sound level to your preference. Once you select a USER mode and then make an adjustment, it automatically stored for the currently selected USER mode. Refer to the "Adjusting the sound level" on the page 14.

Basic operation

Adjusting the sound level

- 1 Press **SEL (MENU/SEL)** on the remote control repeatedly to select the mode you want to adjust from volume, bass, middle, treble, balance and fader.
The indicator lights up in the following order.
VOL → BAS → MID → TRB → BAL → FAD
- 2 Rotate the **MUTE/PWR.** (Press **VOLUME** ^ v on the remote control) to adjust the sound quality.

Indication	Turn right	Turn left
VOL	Increase the volume level.	Decrease the volume level.
BAS	Increase the bass level.	Decrease the bass level.
MID	Increase the middle level.	Decrease the middle level.
TRB	Increase the treble level.	Decrease the treble level.
BAL	Decrease the level of the left speaker(s).	Decrease the level of the right speaker(s).
FAD	Decrease the level of the front speaker(s).	Decrease the level of the rear speaker(s).

Note

When EQ, BRB or XDSS+ is set to "Off", you can adjust the sound level (BAS, MID, TRB) settings.

XDSS+ (Extreme Dynamic Sound System)

- 1 Press and hold **EQ/XDSS/BRB**.
- 2 Each time you press and hold the button, the modes change as follows.
XDSS+ → BRB (TBB → 3D → SBB)
XDSS+ : Improve the treble, bass sound.

BRB (Bass Reverb Blaster)

- 1 Press and hold **EQ/XDSS/BRB**.
- 2 Each time you press and hold the button, the modes change.
- 3 Press **EQ/XDSS/BRB** repeatedly to select sub BRB.
 - TBB (Turbo-Bass Blaster) : Improve the bass sound to make it spectacular.
 - 3D (3D-TremD Blaster) : Positions audio effects real time in 3D space.
 - SBB (Sound field Boost Blaster) : Extremely wide stereo imaging and improved low frequency bass.

Radio operation



Listening to radio stations

- 1 Press **SOURCE** to select the tuner.
- 2 Press the **DRIVE/BAND** repeatedly to select a band.
The indicator lights up in the following order. FM1 → FM2 → FM3 → MW(AM)
- 3 **Auto Seek** : Press </> (I◀◀ ◀◀/▶▶ ▶▶I on the remote control).
When a station is received, searching stops.
Manual Seek : Press and hold </> (I◀◀ ◀◀/▶▶ ▶▶I on the remote control) until "MANUAL" appears, and then press it repeatedly.
The frequencies move up or down step by step.

Storing and recalling broadcast frequencies

You can easily store up to 6 broadcast frequencies for later recall at the touch of a button.

- 1 Press **DRIVE/BAND** to select desired band you want to store.
- 2 Select the desired frequency.
- 3 Press one of preset buttons 1~6 and hold until the beep sound.
The number you have pressed will flash in the preset number indicator and then remain lit. The selected radio station frequency has been stored in memory.
- 4 Repeat steps 1~ 3 to preset other stations.
The next time, you press the same preset button, the radio station frequency is recalled from the memory.

Note

- Up to 18 FM stations, 6 for each of three FM bands and 6 MW(AM) stations can be stored in the memory.
- When a station is stored on the preset numbers on which another station of the same band has already been preset, the previously preset station is automatically erased.

Auto search memory

This function lets you automatically store the 6 strongest broadcast frequencies.

- 1 Press **▲/AS** until "AUTO STORE" appears.
The six strongest broadcast frequencies will be stored under preset button 1~6 in the order of their signal strength.
- 2 To cancel, press **▲/AS**.

To scan the preset stations

Press **▼/PS**. Each preset station appears. To cancel, press **▼/PS**.

To tune in the preset stations

Press **DRIVE/BAND** to select the desired band and press the desired preset button 1~6
The preset station of the preset button 1~6 is displayed and the preset station is received.

RDS operation

RDS Display options

In normal RDS operation the display will indicate the station name. Pressing **DISP** enables you to cycle through the various data types in the following sequence:

CT → FREQUENCY → PTY → RT → PS

- **CT** (Time controlled by the channel)
- **PTY** (Programme type recognition)
- **RT** (Radio text recognition)
- **PS** (Programme Service name)
- **PI** (Programme Identification)
- **AF** (Alternative Frequencies for the actual programme)
- **TP** (Traffic programme Identification)
- **TA** (Traffic Announcement Identification)

PTY (Programme Type) function

To select a certain program type out of the reception band, the following procedure can be used.

- 1 Press and hold **TA/PTY** to select a programme types.
- 2 After, press and hold **TA/PTY** repeatedly for selecting each mode.
Music group → Speech group → Search off
- 3 Press one of preset buttons 1-6
Each time this button is pressed, the display mode changes as follows.

No	Music group	No	Speech group
1.	Pop M, Rock M	1.	News, Affairs, Info
2.	Easy M, Light M.	2.	Sport, Educate, Drama
3.	Classics, Other M	3.	Culture, Science, Varied
4.	Jazz, Country	4.	Weather, Finance, Children
5.	Nation M, Oldies	5.	Social, Religion, Phone In
6.	Folk M	6.	Travel, Leisure, Document

Note

RDS is only available for FM reception.

TA (Traffic Announcement) function

TA reception allows the unit to switch temporarily to a Traffic Announcement from the current source (another FM station, CD, or other connected components).

To switch the TA (Traffic Announcement) function on or off, press **TA/PTY**.

• **TA ON**

Traffic programs and announcements can be automatically received using TP/TA features.

• **TA OFF**

Traffic programs and announcements can not be received using TP/TA features.

CD/MP3/WMA operation

Playing an Audio CD and MP3/WMA Disc

The unit can play MP3/WMA formatted recordings on CD-ROM, CD-R or CD-RW discs. Before playing MP3/WMA recordings, read the notes on MP3/WMA Recordings on page 21. If you change the source, CD play also stops (without ejecting the CD). Next time you select "CD" as the source, CD play starts from where playback has been stopped previously.

- To directly play a file, press **NUMBER (#)** on remote control and then press the track number with **0-9** number.

Pause

- 1 Press **▶/||** during playback.
- 2 To return to playback, press **▶/||** again.

Skip to next track/file

Press briefly **>** (**▶▶▶▶▶** on the remote control) to select the next track or file.

Skip to previous track/file

Press briefly **<** (**◀◀◀◀◀** on the remote control) within 3 seconds of playing time.

Return to the beginning of the current track/file

Press briefly **<** (**◀◀◀◀◀** on the remote control) after 4 seconds of playing time.

Search

Press and hold **</>** (**◀◀◀◀▶▶▶▶▶** on remote control) for about 1 second during playback and then release at the point you want.

Intro scan

The first 10 seconds of each tracks/files (**SCAN**) or each files in the current selected folder (**■ SCAN**) on the disc are played.

- 1 Press **SCAN**.
 - **■ SCAN** **MP3** **WMA** (or **SCAN** **CD**) appears on the display window.
 - Press and hold **SCAN** for about 2 seconds during playback.
 - **SCAN** appears on the display window. **MP3** **WMA**
- 2 Press **SCAN** again.
 - **SCAN** or **■ SCAN** disappear from the display window and The intro scan is cancelled.

Repeat

The current selected tracks/files (**1 RPT**) or folder (**■ RPT**) on the disc is played repeatedly.

- 1 Press **RPT** during playback.
 - **1 RPT** appears on the display window. **CD** **MP3** **WMA**
- 2 Press and hold **RPT** for about 2 seconds during playback.
 - **■ RPT** appears on the display window. **MP3** **WMA**
- 3 Press **RPT** again.
 - **1 RPT** or **■ RPT** disappear from the display window and the repeat mode is cancelled.

CD/MP3/WMA operation

Shuffle

All of the tracks/files (**SHF**) or the current selected folder (**SHF**) on the disc is played randomly.

- 1 Press **SHF** during playback.
 - **SHF** **MP3** **WMA** (or **SHF** **CD**) appears on the display window.
Press and hold **SHF** for about 2 seconds during playback.
 - **SHF** appears on the display window. **MP3** **WMA**
- 2 Press **SHF** again.
 - **SHF** or **SHF** disappear from the display window and the random playback is cancelled.

Note

During random playback, if you press < (I◀◀ ◀◀ on remote control), you won't go back to the previous track.

CD TEXT / ID3 TAG **CD** **MP3** **WMA**

When playing a disc containing information, you can see the CD TEXT/ID3 TAG information.

In CD TEXT, information about the disc (disc title, performer and track title) is recorded.

In a ID3 TAG, information about the file (album title, performer name, song title) is recorded.

In a WMA Content, information about the file (song title, performer name) is recorded.

If there is no information, "NO TEXT" will be shown in the display window.

Press **DISP** repeatedly during MP3/WMA/CD TEXT file playback.

To go to a particular quickly (+10/-10 buttons) **MP3** **WMA**

(If there is no folder or one folder.)

Press **NAS** (**^** on remote control) to skip to the next 10 track, and press **VPS** (**v** on remote control) to skip to the previous 10 track.

To skip to the next or previous folder **MP3** **WMA**

(If there are more than two folders.)

Press **NAS** (**^** on remote control) to skip to the next folder, and press **VPS** (**v** on remote control) to skip to the previous folder.

Note

Time display appearing on the display part when playing VBR file may vary and there may be some difference from actual time (both progress time and VBR are displayed at the same time when playing file).

USB operation

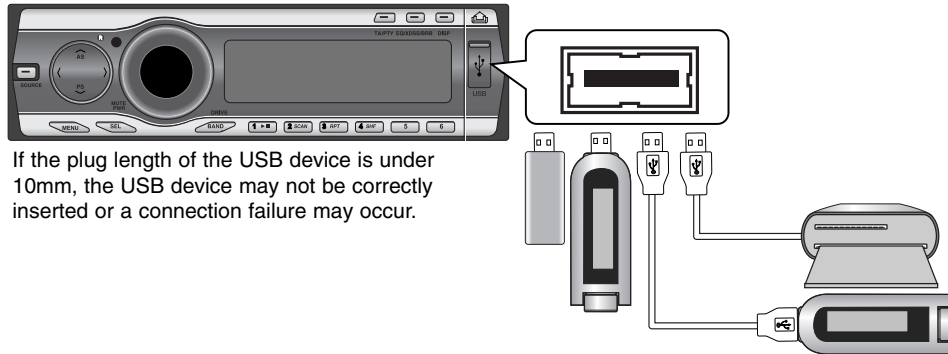

If the plug length of the USB device is under 10mm, the USB device may not be correctly inserted or a connection failure may occur.

Playing a USB device

- 1 Connect one end to the USB port on your USB device and then plug the other end into your unit's USB port.
- 2 After "USB CHECK" appears, playback starts automatically.

Note

The method of files recorded in a USB memory device is the same as when using a DISC.

Moving to another drive

When connecting this unit to Multi reader, press **DRIVE/BAND** to go to the next drive.
(Press **BAND/DRV** on the remote control.)

Each time you press the button, the driver modes changes.

Notes

- Do not remove an MP3 player or memory card while playing via a USB device.
- The maximum number of available files is 999 EA.
- The maximum number of available folders is 255 EA.
- Be sure to save the file in the memory card after formatting.
- There is no support for hard type external cases.
- This unit supports FAT format (2 Kbyte/sector).
- USB Hub is not supported. When connecting this unit to a USB Hub, "USB CHECKING/USB ERROR1" will be shown in the display window.
- Some memory sticks or cards may not be recognised depending on the type of memory card.
- There is no support for a USB device (Card reader, USB memory stick, MP3 player) which requires installation.
- If the connected device is not supported, "USB ERROR1" or "USB ERROR2" will appear on the display window.
- Do not guarantee excess of supplying current. (The maximum supplying current is around 500 mA.
- Do not guarantee USB devices that adopted the OTG technology.

Troubleshooting

Symptom	Cause	Correction
Power doesn't turn on. The unit doesn't operate.	<ul style="list-style-type: none"> Leads and connectors are not properly connected. The fuse is blown. Noise and other factors are causing the built-in microprocessor to operate incorrectly. 	<ul style="list-style-type: none"> Confirm once more that all connections are correct. Rectify the problem that caused the fuse to blow, and then replace it. Be very sure to install the correct fuse with the same rate. Turn the unit off and then on.
Playback is not possible.	<ul style="list-style-type: none"> The disc is dirty. The loaded disc is of a type this unit cannot play. 	<ul style="list-style-type: none"> Clean disc. Check what type the disc.
No sound is heard. The volume level will not rise.	<ul style="list-style-type: none"> Cables are not connected correctly. 	<ul style="list-style-type: none"> Connect the cables correctly.
There's no sound.	<ul style="list-style-type: none"> The volume level is low. 	<ul style="list-style-type: none"> Adjust the volume.
There's audio skipping.	<ul style="list-style-type: none"> This unit is not firmly secured. 	<ul style="list-style-type: none"> Secure this unit firmly.
The unit does not operate correctly even when the appropriate remote control buttons are pressed.	<ul style="list-style-type: none"> Battery power is low. 	<ul style="list-style-type: none"> Load new battery.

Specifications



MP3/WMA Disc compatibility with this unit is limited as follows:

1. Sampling Frequency / 8 - 48kHz (MP3) 22.05 - 48kHz (WMA)
2. Bit rate / within 8 - 320kbps (include VBR) (MP3) 32 -320kbps (WMA)
3. CD-R/CD-RW file system should be "ISO 9660"
4. If you record MP3/WMA files using software which cannot create a FILE SYSTEM, for example "Direct-CD" etc., it will not be possible to playback MP3/WMA files. We recommend that you use "Easy-CD Creator" which creates an ISO9660 file system.

Customers should also note that permission is required in order to download MP3/WMA files and music from the Internet.

Our company has no right to grant such permission.

Permission should always be sought from the copyright owner.

GENERAL

Output Power	.50W x 4CH (Max.)
Power Source	.DC 12V
Speaker impedance	.4Ω
Ground System	Negative
Dimensions (W x H x D)	.180 x 51 x 171 mm (Without Control Panel)
Net Weight	.2.0 kg

CD SECTION

Frequency Response	.20 Hz-20 kHz
S/N Ratio	.85 dB
Distortion	.0.05%
Channel Separation (1kHz)	.60 dB

RADIO SECTION

FM

Frequency Range	.87.5-107.9 or 87.5-108 MHz
S/N Ratio	.53 dB
Distortion	.0.7%
Usable Sensitivity	.12 dBμV

AM (MW)

Frequency Range	.520-1720 or 522-1620 kHz
S/N Ratio	.45 dB
Distortion	.1.0%
Usable Sensitivity	.28 dBμV

USB SECTION

Version	.USB 1.1
---------	----------



P/NO : MFL37340811