

DV246/256K-PM.NA4MLLS\_ENG



# DVD PLAYER

## OWNER'S MANUAL

MODEL : DV246K/DV256K  
DV286K



Before connecting, operating or adjusting this product,  
please read this instruction booklet carefully and completely.





**CAUTION: TO REDUCE THE RISK OF ELECTRIC SHOCK DO NOT REMOVE COVER (OR BACK) NO USER-SERVICEABLE PARTS INSIDE REFER SERVICING TO QUALIFIED SERVICE PERSONNEL.**



This lightning flash with arrowhead symbol within an equilateral triangle is intended to alert the user to the presence of uninsulated dangerous voltage within the product's enclosure that may be of sufficient magnitude to constitute a risk of electric shock to persons.



The exclamation point within an equilateral triangle is intended to alert the user to the presence of important operating and maintenance (servicing) instructions in the literature accompanying the product.

**WARNING: TO PREVENT FIRE OR ELECTRIC SHOCK HAZARD, DO NOT EXPOSE THIS PRODUCT TO RAIN OR MOISTURE.**

**WARNING:** Do not install this equipment in a confined space such as a bookcase or similar unit.

**CAUTION:**

Do not block any ventilation openings. Install in accordance with the manufacturer's instructions.

Slots and openings in the cabinet are provided for ventilation and to ensure reliable operation of the product and to protect it from overheating.

The openings should be never be blocked by placing the product on a bed, sofa, rug or other similar surface. This product should not be placed in a built-in installation such as a bookcase or rack unless proper ventilation is provided or the manufacturer's instruction have been adhered to.

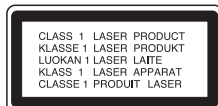

**CAUTION:**

This product employs a Laser System.

To ensure proper use of this product, please read this owner's manual carefully and retain it for future reference.

Should the unit require maintenance, contact an authorized service center.

Performing controls, adjustments, or carrying out procedures other than those specified herein may result in hazardous radiation exposure.

To prevent direct exposure to laser beam, do not try to open the enclosure. Visible laser radiation when open. **DO NOT STARE INTO BEAM.**

**CAUTION:** The apparatus should not be exposed to water (dripping or splashing) and no objects filled with liquids, such as vases, should be placed on the apparatus.

**CAUTION concerning the Power Cord**

**Most appliances recommend they be placed upon a dedicated circuit;**

That is, a single outlet circuit which powers only that appliance and has no additional outlets or branch circuits. Check the specification page of this owner's manual to be certain.

Do not overload wall outlets. Overloaded wall outlets, loose or damaged wall outlets, extension cords, frayed power cords, or damaged or cracked wire insulation are dangerous. Any of these conditions could result in electric shock or fire. Periodically examine the cord of your appliance, and if its appearance indicates damage or deterioration, unplug it, discontinue use of the appliance, and have the cord replaced with an exact replacement part by an authorized servicer.

Protect the power cord from physical or mechanical abuse, such as being twisted, kinked, pinched, closed in a door, or walked upon. Pay particular attention to plugs, wall outlets, and the point where the cord exits the appliance.

To disconnect power from the mains, pull out the mains cord plug. When installing the product, ensure that the plug is easily accessible.

## Contents

<b>Introduction</b> .....	<b>4-7</b>	<b>Operation</b> .....	<b>14-20</b>
<b>About the ☉ Symbol Display</b> .....	<b>4</b>	<b>General Features</b> .....	<b>14</b>
<b>Symbol used in this Manual</b> .....	<b>4</b>	<b>Additional Features</b> .....	<b>15</b>
<b>Notes on Discs</b> .....	<b>4</b>	<b>Playing an Audio CD or MP3/WMA file</b> .....	<b>16</b>
Handling Discs .....	4	<b>Programmed Playback</b> .....	<b>17</b>
Storing Discs .....	4	Repeat Programmed Tracks .....	17
Cleaning Discs .....	4	Erasing a Track from Program List .....	17
<b>Maintenance and Service</b> .....	<b>4</b>	Erasing the Complete Program List .....	17
<b>Types of Playable Discs</b> .....	<b>5</b>	<b>Playing a DVD VR format Disc</b> .....	<b>17</b>
<b>Regional Code</b> .....	<b>5</b>	<b>Viewing a JPEG file</b> .....	<b>18</b>
<b>Front Panel</b> .....	<b>6</b>	Slide Show .....	18
<b>Remote Control</b> .....	<b>7</b>	Still Picture .....	18
Remote Control Operation .....	7	Moving to another File .....	18
Remote Control Battery Installation .....	7	Zoom .....	18
		Rotating the picture .....	18
		To listen to MP3/WMA music while watching picture .....	18
		<b>Playing a DivX Movie file</b> .....	<b>19</b>
		<b>Using the Karaoke Function</b> .....	<b>20</b>
<b>Installation and Setup</b> .....	<b>8-13</b>	<b>Reference</b> .....	<b>21-23</b>
<b>Setting up the Player</b> .....	<b>8</b>	Controlling other TVs with the remote control .....	21
<b>DVD Player Connections</b> .....	<b>8</b>	Video Mode Setting .....	21
Video and Audio Connections to Your TV .....	8	Language Codes .....	22
<b>Audio Connection to Optional Equipment</b> .....	<b>9</b>	Area Codes .....	22
<b>Displaying Disc Information on-screen</b> .....	<b>10</b>	Troubleshooting .....	23
<b>Initial Settings</b> .....	<b>10</b>	Specifications .....	23
General Operation .....	10		
LANGUAGE .....	11		
• Menu Language .....	11		
• Disc Audio / Subtitle / Menu .....	11		
DISPLAY .....	11		
• TV Aspect .....	11		
• Display Mode .....	11		
• Progressive Scan .....	11		
• TV Output Select .....	11		
AUDIO .....	12		
• Dolby Digital / DTS / MPEG .....	12		
• Sample Freq. (Frequency) .....	12		
• DRC (Dynamic Range Control) .....	12		
LOCK (Parental Control) .....	12		
• Rating .....	12		
• Password .....	12		
• Area Code .....	13		
OTHERS .....	13		
• PBC .....	13		
• B.L.E. (Black Level Expansion) .....	13		
• DivX(R) VOD .....	13		
• Score .....	13		

# Introduction

To ensure proper use of this product, please read this owner's manual carefully and retain it for future reference.

This manual provides information on the operation and maintenance of your DVD player. Should the unit require service, contact an authorized service location.

## About the Symbol Display

" " may appear on your TV display during operation and indicates that the function explained in this owner's manual is not available on that specific DVD video disc.

## Symbol Used in this Manual







### Note:

Indicates special notes and operating features.

### Tip:

Indicates tips and hints for making the task easier.

A section whose title has one of the following symbols is applicable only to the disc represented by the symbol.

-  All discs listed below
-  DVD and finalized DVD±R/RW
-  Video CDs
-  Audio CDs
-  MP3 files
-  WMA files
-  DivX files

## Notes on Discs

### Handling Discs

Do not touch the playback side of the disc. Hold the disc by the edges so that fingerprints do not get on the surface. Never stick paper or tape on the disc.



### Storing Discs

After playing, store the disc in its case. Do not expose the disc to direct sunlight or sources of heat and never leave it in a parked car exposed to direct sunlight.

### Cleaning Discs

Fingerprints and dust on the disc can cause poor picture quality and sound distortion. Before playing, clean the disc with a clean cloth. Wipe the disc from the center out.

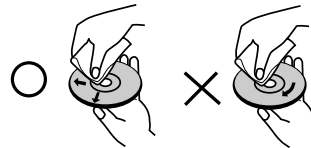

Do not use strong solvents such as alcohol, benzene, thinner, commercially available cleaners, or anti-static spray intended for older vinyl records.

## Maintenance and Service

Refer to the information in this chapter before contacting a service technician.

### Handling the Unit

#### When shipping the unit

Please save the original shipping carton and packing materials. If you need to ship the unit, for maximum protection, re-pack the unit as it was originally packed at the factory.

#### Keeping the exterior surfaces clean

- Do not use volatile liquids such as insecticide spray near the unit.
- Do not leave rubber or plastic products in contact with the unit for a long period of time, since they leave marks on the surface.

#### Cleaning the unit

To clean the player, use a soft, dry cloth. If the surfaces are extremely dirty, use a soft cloth lightly moistened with a mild detergent solution.

Do not use strong solvents such as alcohol, benzene, or thinner, as these might damage the surface of the unit.



#### Maintaining the Unit

The DVD player is a high-tech, precision device. If the optical pick-up lens and disc drive parts are dirty or worn, the picture quality could be diminished.

Depending on the operating environment, regular inspection and maintenance are recommended after every 1,000 hours of use.

For details, please contact your nearest authorized service center.

## Types of Playable Discs

	DVD (8 cm / 12 cm disc)
	Video CD (VCD/SVCD) (8 cm / 12 cm disc)
	Audio CD (8 cm / 12 cm disc)

In addition, this unit plays DVD±R/RW and CD-R/RW, Dual disc that contains audio titles, DivX, MP3, WMA, and/or JPEG files.

**RW COMPATIBLE** This indicates a product feature that is capable of playing DVD-RW discs recorded with Video Recording format.

### Notes:

- Depending on the conditions of the recording equipment or the CD-R/RW (or DVD±R/RW) disc itself, some CD-R/RW (or DVD±R/RW) discs may not be played on the unit.
- Do not use irregularly shaped CDs (e.g., heart-shaped or octagonal) since they may result in malfunctions.

## Regional Code

This unit has a regional code printed on the rear of the unit. This unit can play only DVD discs labelled as the same as the rear of the unit or "ALL".

### Notes on Regional Codes

- Most DVD discs have a globe with one or more numbers in it clearly visible on the cover. This number must match your DVD player's regional code or the disc cannot play.
- If you try to play a DVD with a different regional code from your player, the message "Check Regional Code" appears on the TV screen.

### Notes on Copyrights:

It is forbidden by law to copy, broadcast, show, broadcast via cable, play in public, or rent copyrighted material without permission. This product features the copy protection function developed by Macrovision. Copy protection signals are recorded on some discs. When recording and playing the pictures of these discs picture noise will appear. This product incorporates copyright protection technology that is protected by method claims of certain U.S. patents and other intellectual property rights owned by Macrovision Corporation and other rights owners. The use of this copyright protection technology must be authorized by Macrovision Corporation, and is intended for home and other limited viewing uses only unless otherwise authorized by Macrovision Corporation. Reverse engineering or disassembly is prohibited.

CONSUMERS SHOULD NOTE THAT NOT ALL HIGH DEFINITION TELEVISION SETS ARE FULLY COMPATIBLE WITH THIS PRODUCT AND MAY CAUSE ARTIFACTS TO BE DISPLAYED IN THE PICTURE. IN CASE OF 525 OR 625 PROGRESSIVE SCAN PICTURE PROBLEMS, IT IS RECOMMENDED THAT THE USER SWITCH THE CONNECTION TO THE 'STANDARD DEFINITION' OUTPUT. IF THERE ARE QUESTIONS REGARDING OUR TV SET COMPATIBILITY WITH THIS MODEL 525p AND 625p DVD PLAYER, PLEASE CONTACT OUR CUSTOMER SERVICE CENTER.

## Front Panel

### DV246K

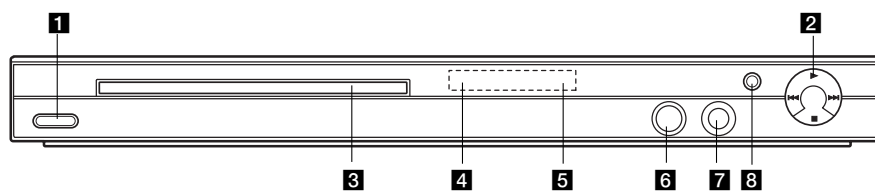

### DV256K

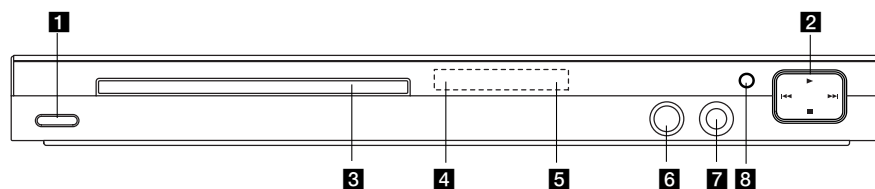

### DV286K

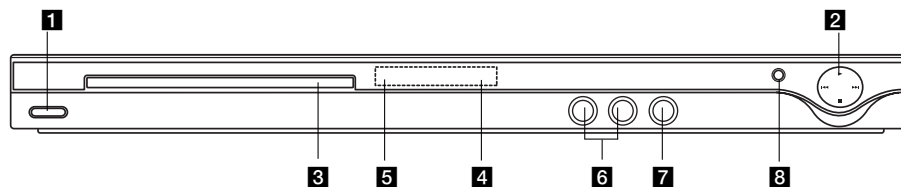

#### 1 POWER

Switches the unit ON or OFF.

#### 2 • ► (PLAY)

Starts playback.

#### • ■ (STOP)

Stops playback.

#### • ◀◀ (SKIP)

Returns to the beginning of current chapter or track or go to the previous chapter or track.

#### • ▶▶ (SKIP)

Go to the next chapter or track.

#### 3 Disc Tray

Insert a disc here.

#### 4 Display window

Shows the current status of the unit.

#### 5 Remote Sensor

Point the remote control here.

#### 6 Microphone jack(s)

Connect a microphone(s) to the MIC socket(s).

#### 7 Microphone volume control

Adjusts microphone volume.

#### 8 ▲ (OPEN / CLOSE)

Opens or closes the disc tray.

## Remote Control

**POWER**  
Switches DVD Player ON or OFF

**OPEN/CLOSE (⬆)**  
Opens and closes the disc tray.

**0-9 numerical buttons**  
Selects numbered options in a menu.

**CLEAR**  
Removes a track number on the Program List or a mark on the Marker Search menu.

**TV Control Buttons**  
POWER: Turns the TV on or off.  
AV: Selects the TV's source.  
PR/CH +/-: Selects TV's channel.  
VOL +/-: Adjusts TV's volume.

**DVD MENU**  
Accesses menu on a DVD disc.

**TITLE**  
Displays title menu, if available.  
◀ / ▶ / ▲ / ▼ (left/right/up/down)  
Selects an option in the menu.

**ENTER**  
Confirms menu selection.

**DISPLAY**  
Accesses On-Screen Display.

**RETURN (↶)**  
Removes the menu.  
Displays the menu of a video CD with PBC.

**AUDIO**  
Selects an audio language or an audio channel.

**SUBTITLE**  
Selects a subtitle language.

**ANGLE**  
Selects a DVD camera angle, if available.

**SETUP**  
Accesses or removes the Setup menu.

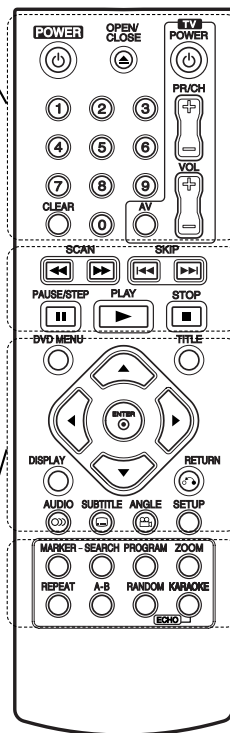

**SCAN (◀◀ / ▶▶)**  
Search backward or forward.

**SKIP (◀◀ / ▶▶)**  
Go to the next chapter or track.  
Returns to the beginning of current chapter or track or go to the previous chapter or track.

**PAUSE / STEP (||)**  
Pauses playback temporarily/ press repeatedly for frame-by-frame playback.

**PLAY (▶)**  
Starts playback.

**STOP (■)**  
Stops playback.

**MARKER**  
Marks any point during playback.

**SEARCH**  
Displays MARKER SEARCH menu.

**PROGRAM**  
Enter the program edit mode.

**ZOOM**  
Enlarges video image.

**REPEAT**  
Repeat chapter, track, title, all.

**A-B**  
Repeat sequence from point A to point B.

**RANDOM**  
Plays tracks in random order.

**KARAOKE (ECHO)**  
Accesses or removes KARAOKE menu.

### Remote Control Operation

Point the remote control at the remote sensor and press the buttons.

### Caution:

Do not mix old and new batteries and never mix different types of batteries such as standard, alkaline, etc.

### Remote Control Battery installation

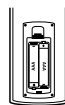

Detach the battery cover on the rear of the remote control, and insert two batteries (size AAA) with ⊕ and ⊖ aligned correctly.

# Installation and Setup

## Setting up the Player

The picture and sound of a nearby TV, VCR, or radio may be distorted during playback. If this occurs, position the player away from the TV, VCR, or radio, or turn off the unit after removing the disc.

## DVD Player Connections

Depending on your TV and other equipment there are various ways you can connect the player. Please refer to the manuals of your TV, stereo system or other devices as necessary for additional connection information.

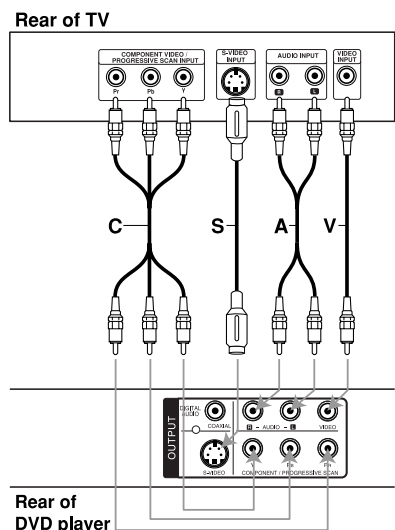

### Caution:

You must set the TV Output Select option on the setup menu to use COMPONENT / PROGRESSIVE SCAN jack or S-Video jack. (Refer to page 11.)

## Video and Audio Connections to Your TV

Make sure the DVD player is connected directly to the TV and not to a VCR, otherwise the DVD image could be distorted by the copy protection system.

**Video** – Connect the VIDEO OUT jack on the DVD player to the video in jack on the TV using the video cable (V).

**S-Video:** Connect the S-VIDEO OUT jack on the DVD Player to the S-Video in jack on the TV using the S-Video cable (S).

**Audio** – Connect the left and right AUDIO OUT jacks of the DVD player to the audio left and right IN jacks on the TV using the audio cables (A). Do not connect the unit's AUDIO OUT jack to the phone in jack (record deck) of your audio system.

**Component Video** – Connect the COMPONENT /PROGRESSIVE SCAN jacks on the unit to the corresponding jacks on the TV using an Y Pb Pr cable (C).

### Note:

If you connect both S-Video and component jack to your TV, the video may be displayed unstably on your TV. You should disconnect one of both connections to solve the problem.

### Progressive Scan

- If your television is a high-definition or “digital ready” television, you may take advantage of the DVD player's progressive scan output for the highest possible video resolution.
- Set the Progressive Scan to “On” on the setup menu for progressive scan signal. (Refer to page 11)
- Progressive scan does not work with the analog video connections (yellow VIDEO OUT jack).



## Audio Connection to Optional Equipment

Connect the DVD player to your optional equipment for audio output.

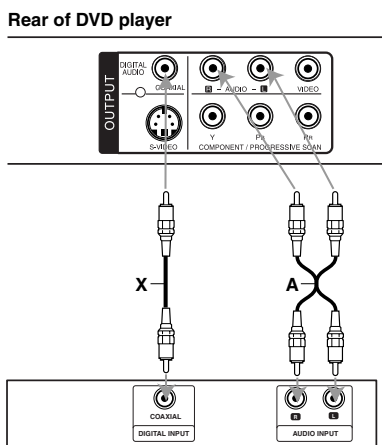

Manufactured under license from Dolby Laboratories. "Dolby", "Pro Logic", and the double-D symbol are trademarks of Dolby Laboratories.

DTS and DTS Digital Out are trademarks of Digital Theater Systems, Inc.

**Amplifier equipped with 2-channel analog stereo or Dolby Pro Logic II / Pro Logic:** Connect the left and right AUDIO OUT jacks on the DVD player to the audio left and right IN jacks on your amplifier, receiver, or stereo system, using the audio cables (A).

**Amplifier equipped with 2-channel digital stereo (PCM) or audio / video receiver equipped with a multi-channel decoder (Dolby Digital™, MPEG 2, or DTS):** Connect one of the DVD Player's DIGITAL AUDIO OUT jacks (COAXIAL X) to the corresponding jack on your amplifier. Use an optional digital (COAXIAL X) audio cable.

### Digital Multi-channel sound

A digital multi-channel connection provides the best sound quality. For this you need a multi-channel audio / video receiver that supports one or more of the audio formats supported by your DVD player such as MPEG 2, Dolby Digital and DTS. Check the receiver manual and the logos on the front of the receiver.

### Notes:

- If the audio format of the digital output does not match the capabilities of your receiver, the receiver produces a strong, distorted sound or no sound at all.
- Six Channel Digital Surround Sound via a digital connection can only be obtained if your receiver is equipped with a Digital Multi-channel decoder.

## Displaying Disc Information on-screen

You can display various information about the disc loaded on-screen.

1. Press DISPLAY to show various playback information.  
The displayed items differ depending on the disc type or playing status.



2. You can select an item by pressing ▲ / ▼ and change or select the setting by pressing ◀ / ▶.
  - Title (Track) – Current title (or track) number/total number of titles (or tracks)
  - Chapter – Current chapter number/total number of chapters
  - Time – Elapsed playing time
  - Audio – Selected audio language or channel
  - Subtitle – Selected subtitle
  - Angle – Selected angle/total number of angles

### Note:

If any button is not pressed for a few seconds, the on-screen display disappears.

## Initial Settings

By using the Setup menu, you can make various adjustments to items such as picture and sound. You can also set a language for the subtitles and the Setup menu, among other things. For details on each Setup menu item, see the pages 11 to 13.

### To display and exit the Menu :

Press SETUP to display the menu. A second press of SETUP will take you back to initial screen.

### To go to the next level :

Press ▶ on the remote control.

### To go back to the previous level :

Press ◀ on the remote control.

## General Operation

1. Press SETUP. The Setup menu appears.

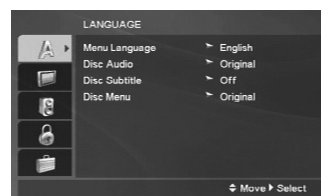

2. Use ▲ / ▼ to select the desired option then press ▶ to move to the second level. The screen shows the current setting for the selected item, as well as alternate setting(s).
3. Use ▲ / ▼ to select the second desired option and then press ▶ to move to the third level.
4. Use ▲ / ▼ to select the desired setting then press ENTER to confirm your selection. Some items require additional steps.
5. Press SETUP or PLAY to exit the Setup menu.

## LANGUAGE

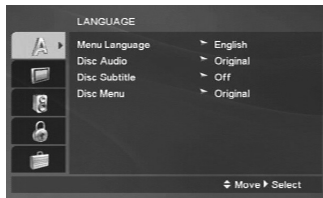

### Menu Language

Select a language for the Setup menu and on-screen display.

### Disc Audio / Subtitle / Menu

Select the language you prefer for the audio track (disc audio), subtitles, and the disc menu.

**Original** – Refers to the original language in which the disc was recorded.

**Other** – To select another language, press numeric buttons and then ENTER to enter the corresponding 4-digit number according to the language code list on the page 22. If you enter the wrong language code, press CLEAR.

**Off (for Disc Subtitle)** – Turn off Subtitle.

## DISPLAY

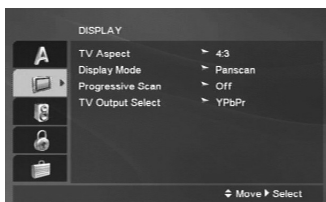

### TV Aspect

**4:3** – Select when a standard 4:3 TV is connected.

**16:9** – Select when a 16:9 wide TV is connected.

### Display Mode

The Display Mode setting works only when the TV Aspect mode is set to "4:3".

**Letterbox** – Displays a wide picture with bands on the upper and lower portions of the screen.

**Panscan** – Automatically displays the wide picture on the entire screen and cuts off the portions that do not fit.

### Progressive Scan

Progressive Scan Video provides the highest quality pictures with less flickering.

If you are using the Component Video jacks for connection to a TV or a monitor that is compatible with a progressive scan signal, set Progressive Scan to On.

#### To Turn ON progressive scan:

Connect component video out of this unit to the input of your TV or monitor, set your TV or monitor to Component Input.

1. Select "Progressive Scan" on the DISPLAY menu then press ►.
2. Select "On" using the ▲ / ▼ buttons.
3. Press ENTER to confirm your selection. The confirm menu will appear.
4. When the confirm menu appears on your screen Cancel is highlighted as default. Use the ◀ / ▶ buttons to highlight Enter.
5. Pressing ENTER will set the player to Progressive scan mode.

#### Caution:

Once the setting for progressive scan output is entered, an image will only be visible on a progressive scan compatible TV or monitor. If you set Progressive Scan to On in error, you must reset the unit.

First, remove the disc in the DVD Player.

Next, press STOP (■) on the remote control and hold it for five seconds before releasing it. The video output will be restored to the standard setting, and a picture will once again be visible on a conventional analog TV or monitor.

#### TV Output Select

Set the player's TV Output Select options according to the TV connection type.

**YPbPr** – When your TV is connected with the COMPONENT / PROGRESSIVE SCAN jacks on this DVD player.

**S-Video** – When your TV is connected with the S-Video jack.

## AUDIO

Each DVD disc has a variety of audio output options. Set the player's AUDIO options according to the type of audio system you use.

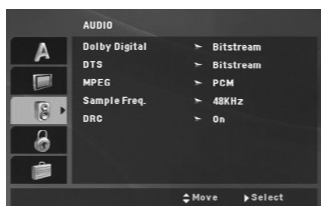

### Dolby Digital / DTS / MPEG

**Bitstream** – Select “Bitstream” if you connect this DVD player's DIGITAL OUT jack to an amplifier or other equipment with a Dolby Digital, DTS or MPEG decoder.

**PCM (for Dolby Digital / MPEG)** – Select when connected to a two-channel digital stereo amplifier. DVDs encoded in Dolby Digital or MPEG will be automatically downmixed to two-channel PCM audio.

**Off (for DTS):** If you select “Off”, the DTS signal is not output through the DIGITAL OUT jack.

### Sample Freq. (Frequency)

If your receiver or amplifier is NOT capable of handling 96 kHz signals, select 48 kHz. When this choice is made, this unit automatically converts any 96 kHz signals to 48 kHz so your system can decode them.

If your receiver or amplifier is capable of handling 96 kHz signals, select 96 kHz.

Check the documentation for your amplifier to verify its capabilities.

### DRC (Dynamic Range Control)

With the DVD format, you can hear a program's soundtrack in the most accurate and realistic presentation. However, you may wish to compress the dynamic range of the audio output (the difference between the loudest sounds and the quietest ones). This allows you to listen to a movie at a lower volume without losing clarity of sound. Set DRC to On for this effect.

## LOCK (Parental Control)

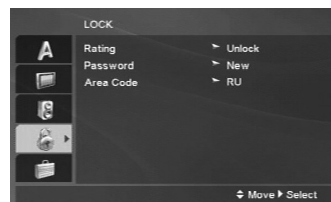

### Rating

Blocks playback of rated DVDs based on their contents. Not all discs are rated.

1. Select “Rating” on the LOCK menu then press ►.
2. To access the LOCK options, you must input the password you have created. If you have not yet entered password, you are prompted to do so. Input a password and press ENTER. Enter it again and press ENTER to verify. If you make a mistake before pressing ENTER, press CLEAR.
3. Select a rating from 1 to 8 using the ▲ / ▼ buttons.

**Rating 1-8:** Rating one (1) has the most restrictions and rating eight (8) is the least restrictive.

**Unlock:** If you select unlock, parental control is not active and the disc plays in full.

4. Press ENTER to confirm your rating selection, then press SETUP to exit the menu.

### Password

You can enter or change password.

1. Select Password on the LOCK menu and then press ►.

#### 2. To make a new password:

Press ENTER when the “New” option is highlighted. Enter a new password using the numerical buttons then press ENTER. Enter the password again to verify.

#### To change the password:

Press ENTER when the “Change” option is highlighted. Enter a current password using the numbered buttons then press ENTER. Enter a new password using the numbered buttons then press ENTER. Enter the password again to verify.

3. Press SETUP to exit the menu.

**If you forget your password**

If you forget your password, you can clear it using the following steps:

1. Press SETUP to display the Setup menu.
2. Input the 6-digit number "210499" and the security code is cleared.

**Area Code**

Enter the code of the area whose standards were used to rate the DVD video disc, based on the list on page 22.

1. Select "Area Code" on the LOCK menu then press ►.
2. Follow the step 2 as shown previous page (Rating).
3. Select the first character using ▲ / ▼ buttons.
4. Press ENTER and select the second character using ▲ / ▼ buttons.
5. Press ENTER to confirm your Area code selection.

**OTHERS****PBC**

Set Playback Control (PBC) to On or Off.

**On:** Video CDs with PBC are played according to the PBC.

**Off:** Video CDs with PBC are played in the same way as Audio CDs.

**B.L.E. (Black Level Expansion)**

To select the black level of playback pictures. Set your preference and monitor's ability.

**On:** Expanded grey scale. (0 IRE cut off)

**Off:** Standard grey scale. (7.5 IRE cut off)

**Note:**

The B.L.E. function works NTSC system only.

**DivX(R) VOD**

We provide you the DivX® VOD (Video On Demand) registration code that allows you to rent and purchase videos based on the DivX® VOD service. For more information, visit [www.divx.com/vod](http://www.divx.com/vod).

1. Select "DivX(R) VOD" option and then press ►.
2. Press ENTER while "Select" is selected and the registration code will appear.  
Use the registration code to purchase or rent the videos from DivX® VOD service at [www.divx.com/vod](http://www.divx.com/vod). Follow the instructions and download the video onto a disc for playback on this unit.
3. Press ENTER to exit.

**Note:**

All the downloaded videos from DivX® VOD can only be played back on this unit.

**Score**

When a chapter/title/track is fully finished, the score will appear in the screen with a fanfare sound.

**On:** Turn the "Score" function on.

**Off:** Turn the "Score" function off.

**Available discs for the score function:**

- DVD discs
- DVD Karaoke Discs
- VCD discs with more than 2 tracks

**Note:**

- The score function is available only when a microphone is connected.
- If the score is below 80, the fanfare sound will not come out. The fanfare sounds differ according to the score.
- If the score function is set to "On" and the microphone is connected while playing a normal disc, the score may appear on the screen in the middle of playback.  
To prevent this problem, set the score function to "Off" or disconnect the microphone.

# Operation

## General features

Buttons	Operations	Discs
OPEN / CLOSE (▲)	Opens or closes the disc tray.	<b>ALL</b>
PAUSE/STEP (⏸)	During playback, press <b>⏸</b> to pause playback. Press <b>⏸</b> repeatedly to play Frame-by-Frame.	<b>ALL</b> <b>DVD</b> <b>VCD</b> <b>DivX</b>
SKIP (⏮ / ⏭)	During playback, press SKIP (⏮ or ⏭) to go to the next chapter/track or to return to the beginning of the current chapter/track. Press SKIP <b>⏮</b> twice briefly to step back to the previous chapter/track.	<b>ALL</b>
SCAN (⏪ / ⏩)	During playback, press SCAN (⏪ or ⏩) repeatedly to select the required scan speed. DVD, DivX disc: 4 steps Video CD, MP3, WMA, Audio CD: 3 steps While the playback is paused, press SCAN (⏪ or ⏩) repeatedly to play in slow motion (4 steps).	<b>ALL</b> <b>DVD</b> <b>VCD</b> <b>DivX</b> (forward only)
REPEAT	During playback, press REPEAT repeatedly to select a desired repeat mode. DVD Video discs: Chapter/Title/Off Video CD, Audio CD, DivX/MP3/WMA discs: Track/All/Off	<b>ALL</b>
A-B	Press the A-B button one at a time to select a point A and point B and repeats a sequence from point A (Starting point) to point B (End point).	<b>DVD</b> <b>VCD</b> <b>DivX</b> <b>ACD</b>
ZOOM	During playback or pause mode, press ZOOM to enlarge the video image. (3 steps) You can move through the zoomed picture using <b>◀ ▶ ▲ ▼</b> buttons. Press CLEAR to exit.	<b>DVD</b> <b>VCD</b> <b>DivX</b>
RANDOM	During playback or in stop mode, press RANDOM for random playback.	<b>VCD</b> <b>ACD</b> <b>MP3</b> <b>WMA</b>
TITLE	If the current DVD title has a menu, the title menu appears on the screen. Otherwise, the disc menu may appear.	<b>DVD</b>
DVD MENU	The disc menu appears on the screen.	<b>DVD</b>
ANGLE (📷)	During playback of DVD disc that contains scenes recorded at different camera angles, press ANGLE repeatedly to select a desired angle.	<b>DVD</b>
SUBTITLE (🗣)	During playback, press SUBTITLE repeatedly to select a desired subtitle language.	<b>DVD</b> <b>DivX</b>
AUDIO (🔊)	During playback, press AUDIO repeatedly to hear a different audio language or audio track.	<b>DVD</b> <b>DivX</b> <b>VCD</b>

**Notes on general features:**

- On a Video CD with PBC, you must set PBC to Off on the setup menu to use the repeat function (See "PBC" on page 13).
- If you press SKIP (▶▶) once during Repeat Chapter (Track) playback, the repeat playback cancels.
- Zoom may not work on some DVDs.
- When you are playing a DVD disc that contains scenes recorded at different camera angles, the angle indicator will blink on the TV screen during the operations as an indication that angle switching is possible.
- If you press I◀◀ once within 3 seconds after the chapter/track has started, the playback goes to the previous chapter/track.

**Additional features****Time Search** DVD VCD DivX

To start playing at any chosen time on the disc:

1. Press DISPLAY during playback.
2. Press ▲ / ▼ to select the time clock icon and ":-:--:" appears.
3. Use numerical buttons to input the required start time in hours, minutes, and seconds from left to right. If you enter the wrong numbers, press CLEAR to remove the numbers you entered. Then input the correct numbers.
4. Press ENTER to confirm. Playback starts from the selected time.

**Marker Search** DVD VCD DivX**To enter a Marker**

You can start playback from up to nine memorized points. To enter a marker, press MARKER at the desired point on the disc. The Marker icon appears on the TV screen briefly. Repeat to enter up to nine markers.

**To Recall or Clear a Marked Scene**

1. During disc playback, press SEARCH. The marker search menu appears on the screen.
2. Within 9 seconds, press ◀ / ▶ to select a marker number that you want to recall or clear.
3. Press ENTER and playback starts from the marked scene. Or Press CLEAR and the marker number is erased from the list.
4. You can play any marker by inputting its number on the marker search menu.

**Last Scene Memory** DVD ACD VCD1.1

This player memorizes last scene from the last disc that is viewed. The last scene remains in memory even if you remove the disc from the player or switch off the player. If you load a disc that has the scene memorized, the scene is automatically recalled.

**Note:**

This player does not memorize the scene of a disc if you switch off the player before commencing to play the disc.

**Screen Saver**

The screen saver appears when you leave the DVD player in Stop mode for about five minutes. If the Screen Saver is displayed for five minutes, the DVD Player automatically turns itself off.

**System Select**

You must select the appropriate system mode for your TV system. If NOdSC appears in the display window, press and hold PAUSE/STEP for more than 5 seconds to be able to select a system (PAL, NTSC, or AUTO).

## Playing an Audio CD or MP3/WMA file

This unit can play Audio CDs or MP3/WMA files.

### MP3/ WMA/ Audio CD

Once you insert an MP3/WMA files recorded media or Audio CD, a menu appears on the TV screen.

Press ▲ / ▼ to select a track/file and then press PLAY or ENTER and playback starts. You can use variable playback functions. Refer to page 14-15.



### ID3 TAG

When playing a file containing information such as track titles, you can see the information by pressing DISPLAY.

[ Title, Artist, Album, Year, Comment ]

### Tips:

- Press DVD MENU to move to the next page.
- On a DISC with MP3/WMA, JPEG and MOVIE file, you can switch MUSIC, PHOTO and MOVIE menu. Press TITLE, and MUSIC, PHOTO or MOVIE word on top of the menu is highlighted.

### MP3 / WMA disc compatibility with this player is limited as follows:

- Sampling frequency: within 8 - 48 kHz (MP3), within 32 - 48kHz (WMA)
- Bit rate: within 8 - 320kbps (MP3), 32 - 192kbps (WMA)
- The player cannot read an MP3/WMA file that has a file extension other than ".mp3" / ".wma".
- CD-R physical format should be ISO 9660
- If you record MP3 / WMA files using software that cannot create a file system (eg. Direct-CD) it is impossible to playback MP3 / WMA files. We recommend that you use Easy-CD Creator, which creates an ISO 9660 file system.
- File names should have a maximum of 8 letters and must incorporate an .mp3 or .wma extension.
- They should not contain special letters such as / ? \* : " < > | etc.
- The total number of files on the disc should be less than 650.
- This DVD player requires discs and recordings to meet certain technical standards in order to achieve optimal playback quality. Pre-recorded DVDs are automatically set to these standards. There are many different types of recordable disc formats (including CD-R containing MP3 or WMA files) and these require certain pre-existing conditions (see above) to ensure compatible playback.

**Customers should note that permission is required in order to download MP3 / WMA files and music from the Internet. Our company has no right to grant such permission. Permission should always be sought from the copyright owner.**



## Programmed Playback

The program function enables you to store your favorite tracks from any disc in the player memory. A program can contain 30 tracks.

1. Insert an Audio CD or MP3/WMA files recorded media. AUDIO CD or MUSIC menu appears.
2. Press PROGRAM. The  mark will appear.

### Note:

Press PROGRAM again to exit the program edit mode, then the  mark will disappear.

**Video CD:** Press PROGRAM while playback is stopped. The program menu appears. Press PROGRAM again to exit the menu.

### Note:

On a Video CD with PBC, you must set PBC to Off on the setup menu to use the programmed playback (See "PBC" on page 13).

3. Select a track on the "List" and then press ENTER to place the selected track on the "Program" list. Repeat to place additional tracks on the list.
4. Select the track you want to start playing on the "Program" list.
5. Press PLAY or ENTER to start. Playback begins in the order in which you programmed the tracks. Playback stops after all of the tracks on the "Program" list have played once.
6. To resume normal playback from programmed playback, select a track on the list and then press PLAY.

### Repeat Programmed Tracks





Press REPEAT to select a desired repeat mode.

- Track: repeats the current track
- All: repeats all the tracks on the "Program" list.
- Off (No display): does not play repeatedly.

### Note:

If you press  once during Repeat Track playback, the repeat playback cancels.

### Erasing a Track from "Program" List

1. Use     to select the track that you wish to erase from the Program list.
2. Press CLEAR. Repeat step 1-2 to erase additional tracks on the list.

### Erasing the Complete Program List

Use     to select "Clear All", then press ENTER.

### Note:

The programs are also cleared when the power is off or the disc is removed.



## Playing a DVD VR format Disc

This unit will play DVD-R/RW disc that are recorded using the DVD-Video format that have been finalized using a DVD-recorder.

This unit will play DVD-RW disc that are recorded using the Video Recording (VR) format.

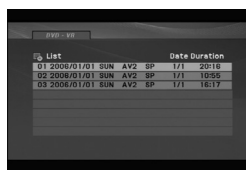
1. Insert a disc and close the tray. The DVD-VR menu appears on the TV screen.



2. Press  /  to select a track then press PLAY or ENTER and playback starts.
3. Press DVD MENU to move to the list menu.

### Note:

- Unfinalized DVD-R/RW discs cannot be played in this player.
- Some DVD-VR disc are made with CPRM data by DVD RECORDER. Player does not support these kinds of discs.

### What is 'CPRM'?

CPRM is a copy protection system (with scramble system) only allowing the recording of 'copy once' broadcast programs. CPRM stands for Content Protection for Recordable Media.

## Viewing a JPEG file

This unit can play JPEG files.

1. Insert a JPEG files recording media. The PHOTO menu appears on the TV screen.



2. Press ▲ / ▼ to select a folder and then press ENTER. A list of files in the folder appears.
3. If you want to view a particular file, press ▲ / ▼ to highlight a file and press ENTER or PLAY.
4. To return to the PHOTO menu while watching pictures, press STOP.

### Tips:

- If you are in a file list and want to return to the previous Folder list, use ▲ / ▼ buttons to highlight and press ENTER.
- Press DVD MENU to move to the next page.
- There are three Slide Speed options : >>> (Fast), >> (Normal) and > (Slow). Use ▲ ▼ ◀ ▶ to highlight . Then, use ◀ / ▶ to select the option you want to use then press ENTER.
- On a DISC with MP3/WMA, JPEG and MOVIE file, you can switch MUSIC, PHOTO and MOVIE menu. Press TITLE, and MUSIC, PHOTO or MOVIE word on top of the menu is highlighted.
- While watching a picture, press RETURN to hide the help menu.

### Slide Show

Use ▲ ▼ ◀ ▶ to highlight the (Slide Show) then press ENTER.

### Still Picture

1. Press PAUSE/STEP during the slide show. The player will now go into the PAUSE mode.
2. To return to the slide show, press PLAY or press PAUSE/STEP again.

### Moving to another File

Press SKIP (◀◀ or ▶▶) or cursor (◀ or ▶) once during viewing a picture to advance to the next or previous file.

### Zoom

During watching pictures, press ZOOM to enlarge the video image (3 steps).

You can move through the zoomed picture using ◀ ▶ ▲ ▼ buttons.

### Rotating the picture

Press ▲ / ▼ during showing a picture to rotate the picture clockwise or counter clockwise.

### To listen to MP3/WMA music while watching picture

1. Insert the disc containing the two types of file in the player.
2. Press TITLE to display the PHOTO menu.
3. Press ▲ / ▼ to select a photo file.
4. Use ▶ to select icon then press ENTER. Playback starts. The playback will continue until STOP is pressed.

### Tip:

To listen to only the desired music while watching pictures, program the desired tracks from the "MUSIC" menu and then proceed as above.

### JPEG disc compatibility with this player is limited as follows:

- Depending upon the size and the number of JPEG files, it could take a long time for this unit to read the disc's contents. If you do not see an on-screen display after several minutes, some of the files may be too large — reduce the resolution of the JPEG files to less than 2M pixels as 2760 x 2048 pixels and burn another disc.
- The total number of files on the disc should be less than 650.
- Some discs may be incompatible due to a different recording format or the condition of disc.
- Ensure that all the selected files have the ".jpg" extensions when copying into the CD layout.
- If the files have ".jpe" or ".jpeg" extensions, please rename them as ".jpg" file.
- File names without ".jpg" extension will not be able to be read by this DVD player. Even though the files are shown as JPEG image files in Windows Explorer.

## Playing a DivX Movie file

Using this DVD Player you can play DivX file.

1. Insert a DivX file recording media. The MOVIE menu appears on the TV screen.



2. Press ▲ / ▼ to select a folder and then press ENTER. A list of files in the folder appears.
3. If you want to view a particular file, press ▲ / ▼ to highlight a file and press ENTER or PLAY. You can use variable playback functions. Refer to page 14-15.
4. To return to the MOVIE menu during playback, press STOP.

### Tips:

- If you are in a file list and want to return to the previous Folder list, use ▲ / ▼ buttons to highlight  and press ENTER.
- Press DVD MENU to move to the next page.
- On a DISC with MP3/WMA, JPEG and MOVIE file, you can switch MUSIC, PHOTO and MOVIE menu. Press TITLE, and MUSIC, PHOTO or MOVIE word on top of the menu is highlighted.
- The disc subtitle may not be displayed properly, if a DivX subtitle is downloaded through the internet.
- If the disc subtitle setup menu does not have the DivX subtitle language you are going to play, the subtitle language may not be displayed properly.

### Notice for displaying the DivX subtitle

If the subtitle does not display properly, please follow the steps below.

1. Press and hold SUBTITLE for about 3 seconds. The language code will appear.
2. Press ◀ / ▶ to select another language code until the subtitle is displayed properly.
3. Press ENTER to continue playback.

### Note:

The DivX subtitle file name has to be identified with the DivX file name to display by this unit.

### DivX disc compatibility with this player is limited as follows:

- Available resolution size of the DivX file is under 720x576 (W x H) pixel.
- The file name of the DivX subtitle is available by 56 characters.
- If there is impossible code to express in the DivX file, it may be displayed as " \_ " mark on the display.
- **If the number of the screen frame is over 30 per 1 second, this unit may not operate normally.**
- **If the video and audio structure of recorded file is not interleaved, either video or audio is outputted.**
- **If the file is recorded with GMC, the unit supports only 1-point of the record level.**
  - \* GMC?  
GMC is the acronym for Global Motion Compensation. It is an encoding tool specified in MPEG4 standard. Some MPEG4 encoders, like DivX, have this option.  
There are different levels of GMC encoding, usually called 1-point, 2-point, or 3-point GMC.

### Playable DivX file

.avi, .mpg, .mpeg

### Playable Subtitle format

SubRip(\*.srt/\*.txt)  
SAMI(\*.smi)  
SubStation Alpha(\*.ssa/\*.txt)  
MicroDVD(\*.sub/\*.txt)  
SubViewer 2.0(\*.sub/\*.txt)  
TMPlayer(\*.txt)  
Dvd Subtitle System(\*.txt)  
VobSub (\*.sub) ➔ Sub/idx, stream based format.

### Playable Codec format

"DIVX3.xx ", "DIVX4.xx ", "DIVX5.xx ",  
"MP43 ", "3IVX "

### Playable Audio format

- "Dolby Digital ", "DTS ", "PCM ", "MP3 ", "WMA "
- Sampling frequency: within 8 - 48 kHz (MP3), within 32 - 48kHz (WMA)
  - Bit rate: within 8 - 320kbps (MP3), 32 - 192kbps (WMA)

## Using the Karaoke Function

1. Load a karaoke disc.
2. Set the MIC VOL control to the minimum level to prevent acoustic feedback (e.g. a loud howling sound) before connecting the microphone.
3. Connect a microphone to MIC socket.

### Note:

If a microphone is not connected, the karaoke menu will not appear.

4. Press PLAY to start playback.
5. Adjust MIC VOL control and then sing a song. If you want to set KARAOKE option, follow the steps 6-8.
6. Press KARAOKE during playback. KARAOKE menu appears.
7. Use ▲ / ▼ to select an desired item (ECHO, MELODY, VOICE, EFFECT or KEY). The display changes as shown in the chart below.

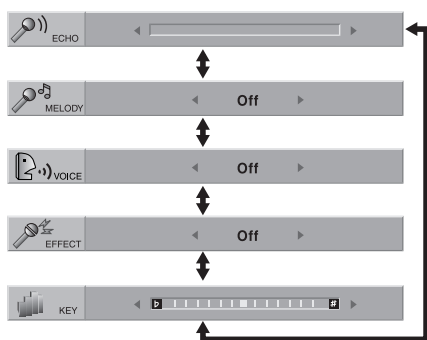

8. Use ◀ / ▶ to adjust the value of the selected item.

**ECHO:** You can adjust the echo volume by pressing ◀ / ▶.

**MELODY:** If you wish to sing only to the backing band or orchestra unaccompanied by a vocal guide melody, set MELODY to Off.

**VOICE:** If you wish to sing a duet with the recorded karaoke singer, select a voice you desire.

Voice Select	Output	
	Left speaker	Right speaker
V1	Voice1	Voice1
V2	Voice2	Voice2
V1+V2	Voice1	Voice2
Off	None voice	None voice

**EFFECT:** You can use Special Effects. Each time ◀ / ▶ is pressed, the Special Effect changes as shown below.

Off → FLANGE → CHORUS

**KEY:** You can change the key by pressing ◀ / ▶.

### Note:

Controlling the key when DVD player is connected to amplifier (receiver) with digital audio connection, may cause mute the sound of the front left/right speakers connected to amplifier (receiver). In that case, you must change the sound mode of the amplifier (receiver) for the output of the speakers.

9. Press KARAOKE to exit the KARAOKE menu.

### Note:

- The microphone may not be available during special playback. (ex. slow)
- The karaoke feature functions only with karaoke-compatible discs.
- The VOICE and MELODY menus may not be available on some karaoke discs.
- For more details, refer to the information attached with the disc.
- There is no microphone's sound output while a disc encoded with DTS is playing back.

# Reference

## Controlling other TVs with the remote control

You can control the sound level, input source, and power switch of your LG TV with the supplied remote control.

You can control the sound level, input source, and power switch of non-LG TVs as well. If your TV is listed in the table below, set the appropriate manufacturer code.

1. While holding down TV POWER button, press the number buttons to select the manufacturer code for your TV (see the table below).
2. Release TV POWER button.

### Code numbers of controllable TVs

If more than one code number is listed, try entering them one at a time until you find the one that works with your TV.

Manufacturer	Code Number
LG / GoldStar	1 (Default), 2
Zenith	1, 3, 4
Samsung	6, 7
Sony	8, 9
Hitachi	4

### Notes:

- Depending on your TV, some or all buttons may not function on the TV, even after entering the correct manufacturer code.
- If you enter a new code number, the code number previously entered will be erased.
- When you replace the batteries of the remote, the code number you have set may be reset to the default setting. Set the appropriate code number again.

## Video Mode Setting

- With certain discs, the playback picture may be flickering or Dot Crawl is shown on straight lines. That means Vertical interpolation or De-interlace is not perfectly matched with the disc. In this case, the picture quality may be improved by changing the video mode.
- To change the video mode, press and hold DISPLAY about 3 seconds during disc playback. The new video mode number selected is displayed on the TV screen. Check whether the video quality has improved. If not, repeat the above procedure until picture quality is improved.
- Video mode change sequence:  
MODE1 → MODE2 → MODE3 → MODE1
- If you turn off the power, the video mode will be back to initial state (MODE1).

### Tip:

#### Detailed Descriptions for Video Modes

**MODE1:** The source material of the DVD video (film material or video material) is determined from disc information.

**MODE2:** Suitable for playing film based content or video based material recorded by the progressive scan method.

**MODE3:** Suitable for playing video based content with comparatively little motion.

### Note:

The video mode setting only works when the Progressive Scan mode is set to "On" in the Setup menu.

## Language Codes

Use this list to input your desired language for the following initial settings:  
Disc Audio, Disc Subtitle, Disc Menu.

Language	Code	Language	Code	Language	Code	Language	Code
Abkhazian	6566	Fiji	7074	Lingala	7678	Singhalese	8373
Afar	6565	Finnish	7073	Lithuanian	7684	Slovak	8375
Afrikaans	6570	French	7082	Macedonian	7775	Slovenian	8376
Albanian	8381	Frisian	7089	Malagasy	7771	Somali	8379
Ameharic	6577	Galician	7176	Malay	7783	Spanish	6983
Arabic	6582	Georgian	7565	Malayalam	7776	Sudanese	8385
Armenian	7289	German	6869	Maltese	7784	Swahili	8387
Assamese	6583	Greek	6976	Maori	7773	Swedish	8386
Aymara	6588	Greenlandic	7576	Marathi	7782	Tagalog	8476
Azerbaijani	6590	Guarani	7178	Moldavian	7779	Tajik	8471
Bashkir	6665	Gujarati	7185	Mongolian	7778	Tamil	8465
Basque	6985	Hausa	7265	Nauru	7865	Tatar	8484
Bengali; Bangla	6678	Hebrew	7387	Nepali	7869	Telugu	8469
Bhutani	6890	Hindi	7273	Norwegian	7879	Thai	8472
Bihari	6672	Hungarian	7285	Oriya	7982	Tibetan	6679
Breton	6682	Icelandic	7383	Panjabi	8065	Tigrinya	8473
Bulgarian	6671	Indonesian	7378	Pashto, Pushto	8083	Tonga	8479
Burmese	7789	Interlingua	7365	Persian	7065	Turkish	8482
Byelorussian	6669	Irish	7165	Polish	8076	Turkmen	8475
Cambodian	7577	Italian	7384	Portuguese	8084	Twì	8487
Catalan	6765	Japanese	7465	Quechua	8185	Ukrainian	8575
Chinese	9072	Javanese	7487	Rhaeto-Romance	8277	Urdu	8582
Corsican	6779	Kannada	7578	Rumanian	8279	Uzbek	8590
Croatian	7282	Kashmiri	7583	Russian	8285	Vietnamese	8673
Czech	6783	Kazakh	7575	Samoan	8377	Volapük	8679
Danish	6865	Kirghiz	7589	Sanskrit	8365	Welsh	6789
Dutch	7876	Korean	7579	Scots Gaelic	7168	Wolof	8779
English	6978	Kurdish	7585	Serbian	8382	Xhosa	8872
Esperanto	6979	Laotian	7679	Serbo-Croatian	8372	Yiddish	7473
Estonian	6984	Latin	7665	Shona	8378	Yoruba	8979
Faroese	7079	Latvian, Lettish	7686	Sindhi	8368	Zulu	9085

## Area Codes

Choose an area code from this list.

Area	Code	Area	Code	Area	Code	Area	Code
Afghanistan	AF	Ethiopia	ET	Malaysia	MY	Saudi Arabia	SA
Argentina	AR	Fiji	FJ	Maldives	MV	Senegal	SN
Australia	AU	Finland	FI	Mexico	MX	Singapore	SG
Austria	AT	France	FR	Monaco	MC	Slovak Republic	SK
Belgium	BE	Germany	DE	Mongolia	MN	Slovenia	SI
Bhutan	BT	Great Britain	GB	Morocco	MA	South Africa	ZA
Bolivia	BO	Greece	GR	Nepal	NP	South Korea	KR
Brazil	BR	Greenland	GL	Netherlands	NL	Spain	ES
Cambodia	KH	Heard and McDonald Islands	HM	Netherlands Antilles	AN	Sri Lanka	LK
Canada	CA	Hong Kong	HK	New Zealand	NZ	Sweden	SE
Chile	CL	Hungary	HU	Nigeria	NG	Switzerland	CH
China	CN	India	IN	Norway	NO	Taiwan	TW
Colombia	CO	Indonesia	ID	Oman	OM	Thailand	TH
Congo	CG	Israel	IL	Pakistan	PK	Turkey	TR
Costa Rica	CR	Italy	IT	Panama	PA	Uganda	UG
Croatia	HR	Jamaica	JM	Paraguay	PY	Ukraine	UA
Czech Republic	CZ	Japan	JP	Philippines	PH	United States	US
Denmark	DK	Kenya	KE	Poland	PL	Uruguay	UY
Ecuador	EC	Kuwait	KW	Portugal	PT	Uzbekistan	UZ
Egypt	EG	Libya	LY	Romania	RO	Vietnam	VN
El Salvador	SV	Luxembourg	LU	Russian Federation	RU	Zimbabwe	ZW

## Troubleshooting

Symptom	Possible Cause	Correction
No power.	<ul style="list-style-type: none"> <li>The power cord is disconnected.</li> </ul>	<ul style="list-style-type: none"> <li>Plug the power cord into the wall outlet securely.</li> </ul>
The power is on, but the DVD player does not work.	<ul style="list-style-type: none"> <li>No disc is inserted.</li> </ul>	<ul style="list-style-type: none"> <li>Insert a disc. (Check the disc indicator in the display window is lit.)</li> </ul>
No picture.	<ul style="list-style-type: none"> <li>The TV is not set to receive DVD signal output.</li> </ul>	<ul style="list-style-type: none"> <li>Select the appropriate video input mode on the TV.</li> </ul>
	<ul style="list-style-type: none"> <li>The video cable is not connected securely.</li> </ul>	<ul style="list-style-type: none"> <li>Connect the video cable securely.</li> </ul>
No sound.	<ul style="list-style-type: none"> <li>The equipment connected with the audio cable is not set to receive DVD signal output.</li> </ul>	<ul style="list-style-type: none"> <li>Select the correct input mode of the audio receiver so you can listen to the sound from the DVD player.</li> </ul>
	<ul style="list-style-type: none"> <li>The power of the equipment connected with the audio cable is turned off.</li> </ul>	<ul style="list-style-type: none"> <li>Turn on the equipment connected with the audio cable.</li> </ul>
	<ul style="list-style-type: none"> <li>The AUDIO options are set to the wrong position.</li> </ul>	<ul style="list-style-type: none"> <li>Set the AUDIO option to the correct position, then turn on the DVD player again by pressing POWER.</li> </ul>
The DVD player does not start playback.	<ul style="list-style-type: none"> <li>An unplayable disc is inserted.</li> </ul>	<ul style="list-style-type: none"> <li>Insert a playable disc. (Check the disc type and regional code.)</li> </ul>
	<ul style="list-style-type: none"> <li>The rating level is set.</li> </ul>	<ul style="list-style-type: none"> <li>Change the rating level.</li> </ul>
The remote control does not work properly.	<ul style="list-style-type: none"> <li>The remote control is not pointed at the remote sensor on the DVD player.</li> </ul>	<ul style="list-style-type: none"> <li>Point the remote control at the remote sensor of the DVD player.</li> </ul>
	<ul style="list-style-type: none"> <li>The remote control is too far from the DVD player.</li> </ul>	<ul style="list-style-type: none"> <li>Operate the remote control closer to the DVD player.</li> </ul>

## Specifications

### General

**Power requirements:** AC 200-240 V , 50/60 Hz

**Power consumption:** 8W

### Dimensions (Approx.):

DV246K/DV256K: 360 x 35 x 202 mm

(14 x 1.4 x 7.9 inches) (W x H x D) without foot

DV286K: 430 x 35 x 202 mm

(17 x 1.4 x 7.9 inches) (W x H x D) without foot

### Net Weight (Approx.):

DV246K/DV256K: 1.4 kg (3.0 lbs)

DV286K: 1.6 kg (3.5 lbs)

### Operating temperature:

5 °C to 35 °C (41 °F to 95 °F)

**Operating humidity:** 5 % to 90 %

### Outputs

#### VIDEO OUT:

1.0 V (p-p), 75 Ω, sync negative, RCA jack x 1

#### S-VIDEO OUT:

(Y) 1.0 V (p-p), 75 Ω, negative sync, Mini DIN 4-pin x

1 (C) 0.3 V (p-p) 75 Ω

#### COMPONENT VIDEO OUT:

(Y) 1.0 V (p-p), 75 Ω, negative sync, RCA jack x 1

(Pb)/(Pr) 0.7 V (p-p), 75 Ω, RCA jack x 2

#### AUDIO OUT:

2.0 Vrms (1 KHz, 0 dB), 600 Ω, RCA jack (L, R) x 1

#### DIGITAL OUT (COAXIAL):

0.5 V (p-p), 75 Ω, RCA jack x 1

#### System

##### Laser:

Semiconductor laser, wavelength 650 nm

**Signal system:** PAL/NTSC

##### Frequency response:

DVD (PCM 96 kHz): 8 Hz to 44 kHz

DVD (PCM 48 kHz): 8 Hz to 22 kHz

CD: 8 Hz to 20 kHz

##### Signal-to-noise ratio:

More than 90 dB (ANALOG OUT connectors only)

**Harmonic distortion:** Less than 0.02%

##### Dynamic range:

More than 95 dB (DVD/CD)

##### Accessories:

Video cable (1), Audio cable (1), Remote control (1),

Batteries (2)

**Note:** Design and specifications are subject to change without prior notice.



P/NO. : MFL38396229