

## Installation and Operating Guide

Model Number | ZDA-810 | DVD Player

<http://www.lg.ca>



P/NO: MFL38970404

Introduction



**CAUTION**  
RISK OF ELECTRIC SHOCK  
DO NOT OPEN



**CAUTION: TO REDUCE THE RISK OF ELECTRIC SHOCK DO NOT REMOVE COVER (OR BACK) NO USER-SERVICE-ABLE PARTS INSIDE REFER SERVICING TO QUALIFIED SERVICE PERSONNEL.**



This lightning flash with arrowhead symbol within an equilateral triangle is intended to alert the user to the presence of uninsulated dangerous voltage within the product's enclosure that may be of sufficient magnitude to constitute a risk of electric shock to persons.



The exclamation point within an equilateral triangle is intended to alert the user to the presence of important operating and maintenance (servicing) instructions in the literature accompanying the product.

**WARNING: TO PREVENT FIRE OR ELECTRIC SHOCK HAZARD, DO NOT EXPOSE THIS PRODUCT TO RAIN OR MOISTURE.**

**WARNING :** Do not install this equipment in a confined space such a bookcase or similar unit.

**CAUTION:** Do not block any ventilation openings. Install in accordance with the manufacturer's instructions.

Slots and openings in the cabinet are provided for ventilation and to ensure reliable operation of the product and to protect it from overheating. The openings should be never be blocked by placing the product on a bed, sofa, rug or other similar surface. This product should not be placed in a built-in installation such as a bookcase or rack unless proper ventilation is provided or the manufacturer's instruction have been adhered to.

**CAUTION:**

This product employs a Laser System. To ensure proper use of this product, please read this owner's manual carefully

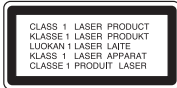

and retain it for future reference. Should the unit require maintenance, contact an authorized service center.

Performing controls, adjustments, or carrying out procedures other than those specified herein may result in hazardous radiation exposure.

To prevent direct exposure to laser beam, do not try to open the enclosure. Visible laser radiation when open. DO NOT STARE INTO BEAM.

**CAUTION:** The apparatus should not be exposed to water (dripping or splashing) and no objects filled with liquids, such as vases, should be placed on the apparatus.

**CAUTION concerning the Power Cord**

**Most appliances recommend they be placed upon a dedicated circuit;**

That is, a single outlet circuit which powers only that appliance and has no additional outlets or branch circuits. Check the specification page of this owner's manual to be certain.

Do not overload wall outlets. Overloaded wall outlets, loose or damaged wall outlets, extension cords, frayed power cords, or damaged or cracked wire insulation are dangerous. Any of these conditions could result in electric shock or fire. Periodically examine the cord of your appliance, and if its appearance indicates damage or deterioration, unplug it, discontinue use of the appliance, and have the cord replaced with an exact replacement part by an authorized servicer.

Protect the power cord from physical or mechanical abuse, such as being twisted, kinked, pinched, closed in a door, or walked upon. Pay particular attention to plugs, wall outlets, and the point where the cord exits the appliance.

To disconnect power from the mains, pull out the mains cord plug. When installing the product, ensure that the plug is easily accessible.

## IMPORTANT SAFETY INSTRUCTIONS

**CAUTION: PLEASE READ AND OBSERVE ALL WARNINGS AND INSTRUCTIONS IN THIS OWNER'S MANUAL. AND THOSE MARKED ON THE PRODUCT. RETAIN THIS BOOKLET FOR FUTURE REFERENCE.**

This product has been designed and manufactured to assure personal safety. Improper use can result in electric shock or fire hazard. The safeguards incorporated in this product will protect you if you observe the following procedures for installation, use, and servicing.

This product does not contain any parts that can be repaired by the user.

**DO NOT REMOVE THE CABINET COVER, OR YOU MAY BE EXPOSED TO DANGEROUS VOLTAGE. REFER SERVICING TO QUALIFIED SERVICE PERSONNEL ONLY.**

1. **Read these instructions.** – All these safety and operating instructions should be read before the product is operated.
2. **Keep these instructions.** – The safety, operating and use instructions should be retained for future reference.
3. **Heed all warnings.** – All warnings on the product and in the operating instructions should be adhered to.
4. **Follow all instructions.** – All operating and use instructions should be followed.
5. **Do not use this apparatus near water.** – For example: near a bath tub, wash bowl, kitchen sink, laundry tub, in a wet basement; or near a swimming pool; and other areas located near water.
6. **Clean only with dry cloth.** – Unplug this product from the wall outlet before cleaning. Do not use liquid cleaners.
7. **Do not block any ventilation openings. Install in accordance with the manufacturer's instructions.** – Slots and openings in the cabinet are provided for ventilation and to ensure reliable operation of the product and to protect it from over-heating. The openings should never be blocked by placing the product on a bed, sofa, rug or other similar surface. This product should not be placed in a built-in installation such as a bookcase or rack unless proper ventilation is provided or the manufacturer's instructions have been adhered to.
8. **Do not install near any heat sources such as radiators, heat registers, stoves, or other apparatus (including amplifiers) that produce heat.**
9. **Do not defeat the safety purpose of the polarized or grounding-type plug. A polarized plug has two blades with one wider than the other. A grounding type plug has two blades and a third grounding prong. The wide blade or the third prong are provided for your safety. If the provided plug does not fit into your outlet, consult an electrician for replacement of the obsolete outlet.**
10. **Protect the power cord from being walked on or pinched particularly at plugs, convenience receptacles, and the point where they exit from the apparatus.**
11. **Only use attachments/accessories specified by the manufacturer.**
12. **Use only with the cart, stand, tripod, bracket, or table specified by the manufacturer, or sold with apparatus. When a cart is used, use caution when moving the cart/product combination to avoid injury from tip-over.**



13. **Unplug this apparatus during lightning storms or when unused for long periods of time.**
14. **Refer all servicing to qualified service personnel. Servicing is required when the product has been damaged in any way, such as power-supply cord or plug is damaged, liquid has been spilled or objects have fallen into the apparatus, the product has been exposed to rain or moisture, does not operate normally, or has been dropped.**

## Contents

Introduction



<b>Introduction</b> .....	<b>4-7</b>
Symbol used in this Manual .....	4
Notes on Discs .....	4
Types of Playable Discs .....	5
Regional Code .....	6
Front Panel .....	6
Remote Control .....	7
<b>Installation</b> .....	<b>8-9</b>
Setting up the Player .....	8
TV Connections .....	8
Audio Connection to Optional Equipment .....	9
<b>Setup</b> .....	<b>10-11</b>
Initial Settings .....	10
General Operation .....	10
Language Setup .....	10
Display Setup .....	10-11
Audio Setup .....	11
Others Setup .....	11
<b>Operation</b> .....	<b>12-15</b>
General Playback Features .....	12-13
Using menus to play Audio CD and MP3/WMA files .....	14
Using menus to play JPEG files .....	14
Using menus to play MPEG4 files .....	15
Language Codes .....	15
<b>Reference</b> .....	<b>16</b>
Troubleshooting .....	16
Specifications .....	16

## Symbol Used in this Manual

### About the Symbol Display

“” may appear on your TV display during operation and indicates that the function explained in this owner’s manual is not available on that specific disc.

A section whose title has one of the following symbols is applicable only to the disc represented by the symbol.

-  All discs listed below
-  DVD and finalized DVD±R/RW
-  Video CDs
-  Audio CDs
-  MP3 files
-  WMA files
-  MPEG4 files

## Notes on Discs

### Handling Discs

Do not touch the playback side of the disc. Hold the disc by the edges so that fingerprints do not get on the surface. Never stick paper or tape on the disc.



### Storing Discs

After playing, store the disc in its case. Do not expose the disc to direct sunlight or sources of heat and never leave it in a parked car exposed to direct sunlight.

### Cleaning Discs

Fingerprints and dust on the disc can cause poor picture quality and sound distortion. Before playing, clean the disc with a clean cloth. Wipe the disc from the center out.

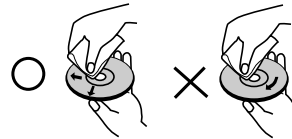

Do not use strong solvents such as alcohol, benzine, thinner, commercially available cleaners, or anti-static spray intended for older vinyl records.

## Types of Playable Discs



### DVD-VIDEO

Discs such as movies that can be purchased or rented.



### DVD-R

Video mode and finalized only



### DVD-RW

Video mode and finalized only



### DVD+R

Video mode only  
Supports the dual layer disc also



### DVD+RW

Video mode only

DVD+ReWritable



### Video CD (VCD/SVCD)



### Audio CD



### CD-R / CD-RW

CD-R/CD-RW discs that contain audio titles, MPEG4, MP3, WMA, or JPEG files.

#### Tip

In addition, this unit plays Dual disc, DVD±R/RW and CD-R/RW that contains audio titles, MPEG4, MP3, WMA, and/or JPEG files.

#### Note

- Depending on the conditions of the recording equipment or the disc itself, some discs cannot be played on the unit.
- Do not use irregularly shaped CDs (e.g., heart-shaped or octagonal) since they may result in malfunctions.

#### MPEG4 file requirement

- Available resolution size: 720x576 (W x H) pixel
- The file names of MPEG4 and subtitle are limited to 20 characters.
- MPEG4 file extensions: “.avi”, “.mpg”, “.mpeg”
- Playable MPEG4 subtitle: SubRip (.srt / .txt), SAMI (.smi), SubStation Alpha(.ssa/.txt), MicroDVD (.sub/.txt), VobSub (.sub) SubViewer 2.0 (.sub/.txt), TMPlayer(.txt), DVD Subtitle System(.txt)
- Playable Codec format: “MP43”, “3IV1”, “3IV2”
- Playable Audio format: “AC3”, “PCM”, “MP3”
- Sampling frequency: within 8 - 48 kHz (MP3)
- Bit rate: within 8 - 320kbps (MP3) less than 6Mbps (MPEG4 file)
- CD-R/RW, DVD±R/RW Format: ISO 9660
- Maximum Files/Disc: Less than 650 (total number of files and folders)

#### Notes on MPEG4 format

- The “⊘” will appear if this unit does not support the MPEG4 file.
- If the video and audio structure of MPEG4 file is not interleaved, returns to the menu screen.
- If there is impossible code to express in the MPEG4 file name, it may be displayed as “\_” mark.
- The unit does not support the file encoded with QPEL.
- If the file is encoded with GMC, the unit supports only 1-point of the record level.

#### MP3/WMA audio file requirement

- File extensions: “.mp3”, “.wma”.
- Sampling frequency: within 8 - 48 kHz (MP3) within 32 - 48kHz (WMA)
- Bit rate: within 8 - 320kbps (MP3) within 32 - 192kbps (WMA)
- CD-R/RW, DVD±R/RW Format: ISO 9660
- Maximum Files/Disc: Less than 650 (total number of files and folders)

## Introduction

## Photo file requirement

- File extensions: “.jpg”
- Photo size: Less than 2MB recommended
- CD-R/RW, DVD±R/RW Format: ISO 9660
- Maximum Files/Disc:  
Less than 650 (total number of files and folders)

## Notes on JPEG file

- Progressive and lossless compression JPEG image files are not supported.
- Depending on the size and number of the JPEG files, it may take several minutes to read the contents of the media.

## Regional Code

This unit has a regional code printed on the rear of the unit. This unit can play only DVD discs labeled same as the rear of the unit or “ALL”.

## Notes on Regional Codes

- Most DVD discs have a globe with one or more numbers in it clearly visible on the cover. This number must match your DVD player's regional code or the disc cannot play.
- If you try to play a DVD with a different regional code from your player, the message “Check Regional Code” appears on the TV screen.

## Notes on Copyrights

It is forbidden by law to copy, broadcast, show, broadcast via cable, play in public, or rent copyrighted material without permission. This product features the copy protection function developed by Macrovision. Copy protection signals are recorded on some discs. When recording and playing the pictures of these discs picture noise will appear. This product incorporates copyright protection technology that is protected by method claims of certain U.S. patents and other intellectual property rights owned by Macrovision Corporation and other rights owners. Use of this copyright protection technology must be authorized by Macrovision Corporation, and is intended for home and other limited viewing uses only unless otherwise authorized by Macrovision Corporation. Reverse engineering or disassembly is prohibited.

CONSUMERS SHOULD NOTE THAT NOT ALL HIGH DEFINITION TELEVISION SETS ARE FULLY COMPATIBLE WITH THIS PRODUCT AND MAY CAUSE ARTIFACTS TO BE DISPLAYED IN THE PICTURE. IN CASE OF 525 PROGRESSIVE SCAN PICTURE PROBLEMS, IT IS RECOMMENDED THAT THE USER SWITCH THE CONNECTION TO THE ‘STANDARD DEFINITION’ OUTPUT. IF THERE ARE QUESTIONS REGARDING OUR TV SET COMPATIBILITY WITH THIS MODEL 525p DVD PLAYER, PLEASE CONTACT OUR CUSTOMER SERVICE CENTER.

## Front Panel

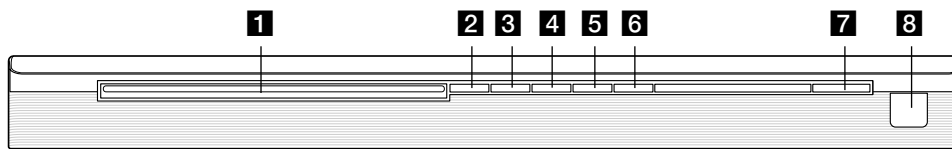

- |  |   |
|--|---|
| <p><b>1</b> <b>Disc Tray</b><br/>Insert a disc here.</p> <p><b>2</b> <b>▲ (OPEN / CLOSE)</b><br/>Opens or closes the disc tray.</p> <p><b>3</b> <b>▶ (PLAY)</b><br/>Starts playback.</p> <p><b>4</b> <b>■ (STOP)</b><br/>Stops playback.</p> | <p><b>5</b> <b>◀◀ (SKIP)</b><br/>Returns to beginning of current chapter or track or go to previous chapter or track.</p> <p><b>6</b> <b>▶▶ (SKIP)</b><br/>Go to the next chapter or track.</p> <p><b>7</b> <b>POWER button and indicator</b><br/>Switches the unit ON and OFF. Lights up red when the unit is turned on.</p> <p><b>8</b> <b>Remote Sensor</b><br/>Point the remote control here.</p> |
|--|---|

## Remote Control

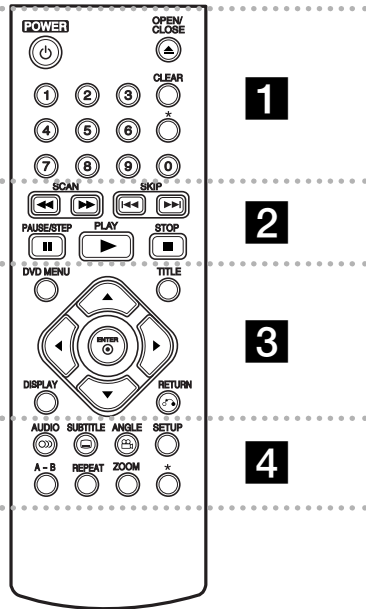

### 1

**POWER** (⏻): Switches DVD Player ON and OFF.

**OPEN/CLOSE** (⏮): Opens and closes the disc tray.

**0-9 numerical buttons**: Selects numbered items in a menu.

**CLEAR**: Exit the zoom mode.

### 2

**SCAN** (⏮ / ⏭): Search backward or forward.

**SKIP** (⏮⏮ / ⏭⏭): Go to next chapter or track. Returns to beginning of current chapter or track or go to previous chapter or track.

**PAUSE / STEP** (⏮⏮): Pauses playback temporarily/ press repeatedly for frame-by-frame playback.

**PLAY** (⏭): Starts playback.

**STOP** (■): Stops playback.

1

2

3

4

### 3

**DVD MENU**: Accesses menu on a DVD disc.

**TITLE**: Displays title menu, if available.

**◀ / ▶ / ▲ / ▼ (left/right/up/down)**: Selects an item in the menu.

**ENTER** (⊙): Acknowledges menu selection.

**DISPLAY**: Accesses On-Screen Display.

**RETURN** (↶): Displays the menu of a video CD with PBC.

### 4

**AUDIO**: Selects an audio language or an audio channel.

**SUBTITLE**: Selects a subtitle language.

**ANGLE**: Selects a DVD camera angle, if available.

**SETUP**: Accesses or removes the Setup menu.

**A-B**: Repeat sequence from point A to point B.

**REPEAT**: Repeat chapter, track, title, all.

**ZOOM**: Enlarges video image.

\* Buttons are not available.

## Remote Control Operation

Point the remote control at the remote sensor and press the buttons.

## Remote Control Battery Installation

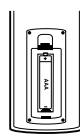

Detach the battery cover on the rear of the remote control, and insert a battery (size AAA) with ⊕ and ⊖ aligned correctly. We recommend to use the alkaline battery.

## Setting up the Player

The picture and sound of a nearby TV, VCR, or radio may be distorted during playback. If this occurs, position the player away from the TV, VCR, or radio, or turn off the unit after removing the disc.

## TV Connections

### Installation

- Depending on your TV and other equipment there are various ways you can connect the player. Please refer to the manuals of your TV, stereo system or other devices as necessary for additional connection information.
- Make sure the DVD player is connected directly to the TV and not to a VCR, otherwise the DVD image could be distorted by the copy protection system.

### Basic TV Connection (Composite Video and Audio Connections)

Connect the VIDEO OUTPUT and AUDIO OUTPUT jacks on the DVD player to the video and audio input jacks on the TV using the video (V) and audio (A) cable.

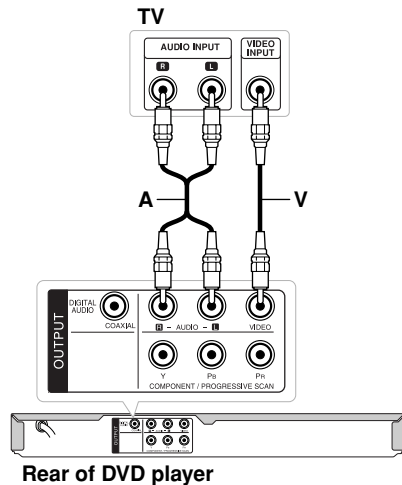

### Advanced TV Connection (Component Video and Audio Connections)

Connect the COMPONENT VIDEO OUTPUT and AUDIO OUTPUT jacks on the DVD player to the component video and audio input jacks on the TV using the component video (C) and audio (A) cable.

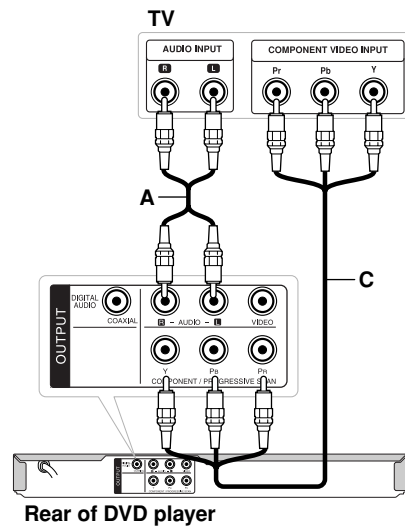

### To enjoy progressive video

- Set the [Progressive Scan] option to "On" on the setup menu for progressive signal, see page 11.
- Progressive scan work only with the component video connection.

### Caution

If your TV does not accept the Progressive Scan format, the picture will appear scrambled. If you set [Progressive Scan] option to [On] in error, you must set the option to [Off]. Remove any disc from the unit and close the disc tray. Then press and hold STOP on the remote control for five seconds.

### Note

Do not connect the DVD Player's AUDIO OUTPUT jack to the phone in jack (record deck) of your audio system.



## Audio Connection to Optional Equipment

Connect the DVD player to your optional equipment for audio output.

### Amplifier equipped with 2-channel analog stereo or Dolby Pro Logic II / Pro Logic

Connect the left and right AUDIO OUTPUT jacks on the DVD player to the audio left and right IN jacks on your amplifier, receiver, or stereo system, using the audio cables (A).

### Amplifier equipped with 2-channel digital stereo (PCM) or audio / video receiver equipped with a multi-channel decoder (Dolby Digital™, MPEG 2, or DTS)

Connect one of the DVD Player's DIGITAL AUDIO OUTPUT jacks (COAXIAL X) to the corresponding in jack on your amplifier. Use an optional digital (coaxial X) audio cable.

### Digital Multi-channel sound

A digital multi-channel connection provides the best sound quality. For this you need a multi-channel audio / video receiver that supports one or more of the audio formats supported by your DVD player such as MPEG 2, Dolby Digital and DTS. Check the receiver manual and the logos on the front of the receiver.

#### Note

- If the audio format of the digital output does not match the capabilities of your receiver, the receiver produces a strong, distorted sound or no sound at all.
- Six Channel Digital Surround Sound via a digital connection can only be obtained if your receiver is equipped with a Digital Multi-channel decoder.

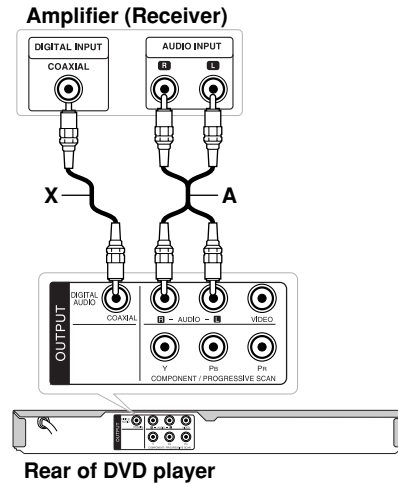

Manufactured under license from Dolby Laboratories. "Dolby", "Pro Logic", and the double-D symbol are trademarks of Dolby Laboratories.

DTS and DTS Digital Out are trademarks of Digital Theater Systems, Inc.

## Initial Settings

By using the Setup menu, you can make various adjustments to items such as picture and sound.



### 1 LANGUAGE

- Menu Language
- Disc Audio / Disc Subtitle / Disc Menu

### 2 DISPLAY

- TV Aspect
- Display Mode
- Progressive Scan

### 3 AUDIO

- Dolby Digital / DTS / MPEG
- Sample Freq.
- DRC

### 4 OTHERS

- PBC
- MPEG4 Subtitle

#### To display and exit the Menu:

Press SETUP to display the menu. A second press of SETUP will take you back to initial screen.

#### To go to the next level:

Press ► on the remote control.

#### To go back to the previous level:

Press ◀ on the remote control.

## General Operation

1. Press SETUP.  
The Setup menu appears.
2. Use ▲ / ▼ to select the desired option then press ► or ENTER to move to the second level.
3. Use ▲ / ▼ to select the second desired option then press ► to move to the third level.
4. Use ▲ / ▼ to select the desired setting then press ENTER to confirm your selection. Some items require additional steps.
5. Press SETUP or PLAY to exit the Setup menu.

## Language Setup

### Menu Language

Select a language for the Setup menu and on-screen display.

### Disc Audio / Disc Subtitle / Disc Menu

Select the language you prefer for the audio track (disc audio), subtitles, and the disc menu.

Original – Refers to the original language in which the disc was recorded.

Other – To select another language. Press number buttons then ENTER to enter the corresponding 4-digit number according to the language code list on page 15. If you enter the wrong language code, press CLEAR.

Off (for Disc Subtitle) – Turn off Subtitle.

## Display Setup

### TV Aspect

4:3 – Select when a standard 4:3 TV is connected.

16:9 – Select when a 16:9 wide TV is connected.

### Display Mode

Display Mode setting works only when the TV Aspect mode is set to "4:3".

**Letterbox** – Displays a wide picture with bands on the upper and lower portions of the screen.

**Panscan** – Automatically displays the wide picture on the entire screen and cuts off the portions that do not fit.

### Progressive Scan

Progressive Scan Video provides the high quality pictures with less flickering. If you are using the Component Video jacks for connection to a TV or monitor that is compatible with a progressive scan signal, set [Progressive Scan] to [On]. Press ENTER to confirm your selection. The confirm menu will appear.

#### Caution

If your TV does not accept the Progressive Scan format, the picture will appear scrambled. If you set [Progressive Scan] option to [On] in error, you must set the option to [Off]. Remove any disc from the unit and close the disc tray. Then press and hold STOP on the remote control for five seconds.

### Audio Setup

Each DVD disc has a variety of audio output options. Set the player's AUDIO options according to the type of audio system you use.

#### Dolby Digital / DTS / MPEG

**Bitstream** – Select "Bitstream" if you connect this unit's DIGITAL AUDIO OUTPUT jack to an amplifier or other equipment with a Dolby Digital, DTS or MPEG decoder.

**PCM (for Dolby Digital / MPEG)** – Select when connected to a two-channel digital stereo amplifier. DVDs encoded in Dolby Digital or MPEG will be automatically downmixed to two-channel PCM audio.

**Off (for DTS)** – If you select "Off", the DTS signal is not output through the DIGITAL AUDIO OUTPUT jack.

#### Sample Freq. (Frequency)

Check the documentation for your amplifier to verify its capabilities.

**48 kHz** – If your receiver or amplifier is NOT capable of handling 96 kHz signals, select 48 kHz. When this choice is made, this unit automatically converts any 96 kHz signals to 48 kHz so your system can decode them.

**96 kHz** – If your receiver or amplifier is capable of handling 96 kHz signals, select 96 kHz.

#### DRC (Dynamic Range Control)

The dynamic range (the difference between the loudest sound and the quietest one) can be compressed during playback of a DVD encoded in Dolby Digital format. This function takes effect when a DVD VIDEO disc recorded in Dolby Digital format is played back at low or middle volume. Set DRC to On for this effect.

### Others Setup

#### PBC

Set Playback Control (PBC) to On or Off.

**On** – Video CDs with PBC are played according to the PBC.

**Off** – Video CDs with PBC are played the same way as Audio CDs.

#### MPEG4 Subtitle

You can adjust the default MPEG4 subtitle's size displayed during MPEG4 playback.

## General Playback Features

1. Load your chosen disc in the tray, with the playback side down.
2. Press PLAY (▶) to start playback.
3. To stop the playback, press STOP (■).

### Tip

- The unit records the stopped point, depending on the disc. "■■■" appears on the screen. Press PLAY to resume playback (from the scene point).
- If you press STOP again or unload the disc ("■" appears on the screen.), the unit will clear the stopped point.

4. Press OPEN/CLOSE (⏏) to remove the disc.  
Press OPEN/CLOSE (⏏) to close disc tray or press POWER (⏻), the disc tray closes automatically and unit turns off.

### If a menu screen is displayed

The menu screen may be displayed first after loading a DVD or Video CD which contains a menu.

#### DVD

Use the ◀ / ▶ / ▲ / ▼ buttons to select the title/chapter you want to view, then press ENTER to start playback.  
Press TITLE or DVD MENU to return to the menu screen.

#### VCD

- Use the number buttons to select the track you want to view.  
Press RETURN to return to the menu screen.
- Menu setting and the exact operating procedures for using the menu may differ depending on the disc. Follow the instructions on the each menu screen. You may also set PBC to [OFF] under Setup menu (see page 11).

## Displaying Disc Information on-screen

Some items can be changed using the menu.

1. Press DISPLAY during playback.

 01/17 Title (Track) Number

 01/21 Chapter Number  
(DVD disc only)

 0:00:16 Time search (page 13)

2. Press ◀ / ▶ to select an item.  
The selected item is highlighted.
3. Press ▲ / ▼ to change the setting.  
Press ENTER.  
You can also use the number buttons if appropriate (e.g. inputting the title number).

### Note

If no button is pressed for a few seconds, the on-screen display disappears.

## To pause playback **ALL**

During playback, press PAUSE/STEP (⏸) to pause playback.

## Frame-By-Frame Playback

**DVD** **MPEG4** **VCD**

While the playback is paused, press PAUSE/STEP (⏸) repeatedly.

## Skip Scan **ALL**

During playback, press SKIP (⏮ / ⏭) to go to the next chapter/track or to return to the beginning of the current chapter/track.

Press SKIP (⏮) twice briefly to step back to the previous chapter/track.

## Variable Speed Scan **ALL**

During playback, press SCAN (⏪ / ⏩) repeatedly to select the required scan speed.

DVD: 4 steps

VCD, ACD, MP3, WMA, MPEG4: 3 steps

**Slow Motion** DVD MPEG4 VCD

While the playback is paused, press SCAN (▶▶) repeatedly to play in slow motion (4 steps, forward only).

**Repeat Playback** ALL

During playback, press REPEAT repeatedly to select a desired repeat mode.

DVD: Chapter/Title/Off

VCD, MPEG4, ACD, MP3, WMA:  
Track/All/Off

**Note**

- On a Video CD with PBC, you must set PBC to Off on the setup menu to use the repeat function (See "PBC" on page 11).
- If you press SKIP (▶▶) once during Repeat Chapter (Track) playback, the repeat playback cancels.

**A-B Repeat Playback** ALL

During playback, each press of A-B button to select point A and point B and repeats a sequence from point A (Starting point) to point B (End point). Press A-B again to cancel.

**Zoom** DVD MPEG4 VCD

During playback or pause mode, press ZOOM to enlarge the video image. (If an MPEG4 file is playing back, the playback will be paused.)

You can move through the zoomed picture using ◀ / ▶ / ▲ / ▼ buttons. Press CLEAR to exit.

**Note**

Zoom may not work on some DVDs.

**Title** DVD

If the current DVD title has a menu, the title menu appears on the screen when TITLE button is pressed. Otherwise, the disc menu may appear.

**DVD Menu** DVD

The disc menu appears on the screen when DVD MENU button is pressed.

**Angle Selection** DVD

During playback of DVD disc contains scenes recorded different camera angles, press ANGLE repeatedly to select a desired angle.

**Subtitle Selection** DVD MPEG4

During playback, press SUBTITLE repeatedly to select a desired subtitle language.

**Audio Selection** DVD MPEG4 VCD

During playback, press AUDIO repeatedly to hear a different audio language or audio track.

**Screen Saver**

The screen saver appears when you leave the DVD player in Stop mode for about five minutes. If the Screen Saver is displayed for five minutes, the DVD Player automatically turns itself off.

**Time Search** DVD VCD MPEG4

To start playing at any chosen time on the disc:

1. Press DISPLAY during playback.
2. Press ◀ / ▶ to select the time clock icon.
3. Input the required start time in hours, minutes, and seconds from left to right. Playback starts from the selected time. If you enter the wrong numbers, press CLEAR to remove the numbers you entered. Then input the correct numbers.

## Using menus to play Audio CD and MP3/WMA files

This unit can play AUDIO CDs or MP3/WMA files.

### Audio CD

Once you insert an audio CD, a menu appears on the TV screen. Press ▲ / ▼ to select a track then press PLAY or ENTER to start playback.

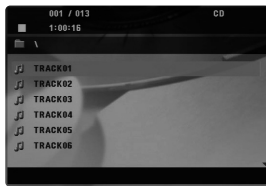

### MP3 / WMA

1. Press ▲ / ▼ to select a folder, and press PLAY or ENTER to see the folder contents.
2. Press ▲ / ▼ to select a file then press PLAY or ENTER. Playback starts.

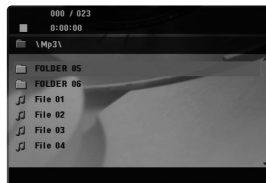

#### Tip

- If you want to move to the upper directory, use ▲ / ▼ to highlight  and press PLAY or ENTER.
- Press DVD MENU to move to the next page. Press TITLE to move to the previous page.

## Using menus to play JPEG files

This unit can play JPEG file.

1. Insert a JPEG file recording media and the menu appears on the TV screen.

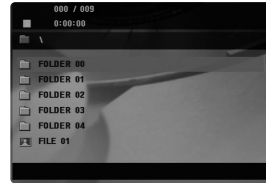

2. Press ▲ / ▼ to select a folder, and press PLAY or ENTER to see the folder contents.
3. Press ▲ / ▼ to select a file then press PLAY or ENTER. Slide Show starts.

### Stop the slide show

During slide show, press STOP to move to the menu.

### Pause the slide show

Press PAUSE/STEP during slide show. To return to the slide show, press PLAY or press PAUSE/STEP again.

### Moving to another File

Press SKIP (◀◀ or ▶▶) once while viewing a picture to advance to the next or previous file.

### Zoom picture

During slide show, press ZOOM to enlarge the video image.

You can move through the zoomed picture using ◀ / ▶ / ▲ / ▼ buttons. Press CLEAR to exit.

### Rotating the picture

During slide show, press ◀ / ▶ to rotate the picture clockwise or counter clockwise.

### To flip the picture

Press ▲ / ▼ during showing a picture to flip the picture horizontally or a vertically.

## Using menus to play MPEG4 files

This unit can play MPEG4 file.

1. Insert a MPEG4 file recording media and the menu appears on the TV screen.

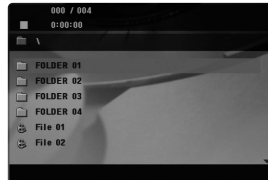

2. Press ▲ / ▼ to select a folder, and press PLAY or ENTER to see the folder contents.
3. Press ▲ / ▼ to select a file then press PLAY or ENTER. Playback starts.
  - The “⊘” will appear if this unit does not support the MPEG4 file.
  - During playback, this unit skips the unplayable MPEG4 file.
4. To return to the menu during playback, press STOP.

### Tip

- If you want to move to the upper directory, use ▲ / ▼ to highlight □ and press PLAY or ENTER.
- Press DVD MENU to move to the next page. Press TITLE to move to the previous page.
- The disc subtitle may not be displayed properly, if a MPEG4 subtitle is downloaded through the internet.
- You can use variable playback functions. Refer to page 12-13.

### Notice for displaying the MPEG4 subtitle

If the subtitle does not display properly, please follow the steps below.

1. Press and hold SUBTITLE for about 3 seconds during playback.  
The language code will appear.
2. Press ◀ / ▶ to select another language code until the subtitle is displayed properly.
3. Press ENTER.

#### Note:

The MPEG4 subtitle file name has to be identified with the MPEG4 file name to display by this unit.

## Language Codes

Use this list to input your desired language for the following initial settings:  
Disc Audio, Disc Subtitle, Disc Menu.

Abkhazian	6566	Lingala	7678
Afar	6565	Lithuanian	7684
Afrikaans	6570	Macedonian	7775
Albanian	8381	Malagasy	7771
Ameharic	6577	Malay	7783
Arabic	6582	Malayalam	7776
Armenian	7289	Maltese	7784
Assamese	6583	Maori	7773
Aymara	6588	Marathi	7782
Azerbaijani	6590	Moldavian	7779
Bashkir	6665	Mongolian	7778
Basque	6985	Nauru	7865
Bengali	6678	Nepali	7869
Bhutani	6890	Norwegian	7879
Bihari	6672	Oriya	7982
Breton	6682	Panjabi	8065
Bulgarian	6671	Pashto, Pushto	8083
Burmese	7789	Persian	7065
Byelorussian	6669	Polish	8076
Cambodian	7577	Portuguese	8084
Catalan	6765	Quechua	8185
Chinese	9072	Rhaeto-Romance	8277
Corsican	6779	Rumanian	8279
Croatian	7282	Russian	8285
Czech	6783	Samoan	8377
Danish	6865	Sanskrit	8365
Dutch	7876	Scots Gaelic	7168
English	6978	Serbian	8382
Esperanto	6979	Serbo-Croatian	8372
Estonian	6984	Shona	8378
Faroese	7079	Sindhi	8368
Fiji	7074	Singhalese	8373
Finnish	7073	Slovak	8375
French	7082	Slovenian	8376
Frisian	7089	Somali	8379
Galician	7176	Spanish	6983
Georgian	7565	Sudanese	8385
German	6869	Swahili	8387
Greek	6976	Swedish	8386
Greenlandic	7576	Tagalog	8476
Guarani	7178	Tajik	8471
Gujarati	7185	Tamil	8465
Hausa	7265	Tatar	8484
Hebrew	7387	Telugu	8469
Hindi	7273	Thai	8472
Hungarian	7285	Tibetan	6679
Icelandic	7383	Tigrinya	8473
Indonesian	7378	Tonga	8479
Interlingua	7365	Turkish	8482
Irish	7165	Turkmen	8475
Italian	7384	Twi	8487
Japanese	7465	Ukrainian	8575
Javanese	7487	Urdu	8582
Kannada	7578	Uzbek	8590
Kashmiri	7583	Vietnamese	8673
Kazakh	7575	Volapük	8679
Kirghiz	7589	Welsh	6789
Korean	7579	Wolof	8779
Kurdish	7585	Xhosa	8872
Laotian	7679	Yiddish	7473
Latin	7665	Yoruba	8979
Latvian, Lettish	7686	Zulu	9085

## Troubleshooting

### No power.

- Plug the power cord into the wall outlet securely.

### The power is on, but the DVD player does not work.

- Insert a disc.

### No picture.

- Select the appropriate video input mode on the TV.
- Connect the video cable securely.

### No sound.

- Select the correct input mode of the audio receiver.
- Turn on the equipment connected with the audio cable.
- Set the AUDIO option to the correct position. (page 11)

### The DVD player does not start playback.

- Insert a playable disc. (Check the disc type and regional code.)

### The remote control does not work properly.

- Point the remote control at the remote sensor of the DVD player.
- Operate the remote control closer to the DVD player.

## Reference

### Note

- To ensure proper use of this product, please read this owner's manual carefully and retain for future reference.
- This manual provides information on the operation and maintenance of your DVD player. Should the unit require service, contact an authorized service location.

## Specifications

### General

- Power requirements: AC 120 V, 60 Hz
- Power consumption: 5 W
- Dimensions (Approx.): 360 x 35 x 200 mm (14.2 x 1.4 x 7.9 inches) (W x H x D) without foot
- Net Weight (Approx.): 1.4 kg (3.1 lbs)
- Operating temperature: 5 °C to 35 °C (41 °F to 95 °F)
- Operating humidity: 5 % to 90 %

### Outputs

- VIDEO OUTPUT: 1.0 V (p-p), 75 Ω, sync negative, RCA jack x 1
- COMPONENT VIDEO OUTPUT: (Y) 1.0 V (p-p), 75 Ω, negative sync, RCA jack x 1 (PB)/(PR) 0.7 V (p-p), 75 Ω, RCA jack x 2
- AUDIO OUTPUT: 2.0 V<sub>rms</sub> (1 KHz, 0 dB), 600 Ω, RCA jack (L, R) x 1
- DIGITAL AUDIO OUTPUT (COAXIAL): 0.5 V (p-p), 75 Ω, RCA jack x 1

### System

- Laser: Semiconductor laser
- Signal system: NTSC
- Frequency response: DVD (PCM 96 kHz): 8 Hz to 44 kHz  
DVD (PCM 48 kHz): 8 Hz to 20 kHz  
CD: 8 Hz to 20 kHz
- Signal-to-noise ratio: More than 85 dB (ANALOG OUTPUT connectors only)
- Harmonic distortion: Less than 0.02%
- Dynamic range: More than 95 dB (DVD/CD)
- Accessories: Video cable (1), Audio cable (1), Remote control (1), Batteries (1)

### Note

Design and specifications are subject to change without prior notice.