

Installation Guide & Warranty

Model Number | H20J54DT HealthView™ TV



Table of Contents see page **5**

Master TV Setup see page **7**



Zenith and the lightning Z logo are registered trademarks of Zenith Electronics Corporation





For Customer Support/Service, please call:

1-888-865-3026

www.lgcommercial.com • www.zenith.com

RECORD THE H20J54DT SERIAL NUMBER
The serial number of the HealthView™ TV is located on the back of the cabinet. For future reference, we suggest that you record the number here:

Serial No. _____

	WARNING RISK OF ELECTRIC SHOCK DO NOT OPEN	
WARNING: TO REDUCE THE RISK OF ELECTRIC SHOCK DO NOT REMOVE COVER (OR BACK). NO USER SERVICEABLE PARTS INSIDE. REFER TO QUALIFIED SERVICE PERSONNEL		
	The lightning flash with arrowhead symbol, within an equilateral triangle, is intended to alert the user to the presence of uninsulated "dangerous voltage" within the product's enclosure that may be of sufficient magnitude to constitute a risk of electric shock to persons.	
	The exclamation point within an equilateral triangle is intended to alert the user to the presence of important operating and maintenance (servicing) instructions in the literature accompanying the appliance	

WARNING:

TO PREVENT FIRE OR SHOCK HAZARDS, DO NOT EXPOSE THIS PRODUCT TO RAIN OR MOISTURE.

POWER CORD POLARIZATION:

This product is equipped with a 3-wire grounding-type alternating current line plug. This plug will fit into the power outlet only one way. This is a safety feature. If you are unable to insert the plug fully into the outlet, contact your electrician to replace your obsolete outlet. Do not defeat the safety purpose of the three-wire ground type plug.

NOTE TO CABLE/TV INSTALLER:

This reminder is provided to call the cable TV system installer's attention to Article 820-40 of the National Electric Code (U.S.A.). The code provides guidelines for proper grounding and, in particular, specifies that the cable ground shall be connected to the grounding system of the building, as close to the point of the cable entry as practical.

REGULATORY INFORMATION:

This equipment has been tested and found to comply with the limits for a Class B digital device, pursuant to Part 15 of the FCC Rules. These limits are designed to provide reasonable protection against harmful interference when the equipment is operated in a residential installation. This equipment generates, uses and can radiate radio frequency energy and, if not installed and used in accordance with the instruction manual, may cause harmful interference to radio communications. However, there is no guarantee that interference will not occur in a particular installation. If this equipment does cause harmful interference to radio or television reception, which can be determined by turning the equipment off and on, the user is encouraged to try to correct the interference by one or more of the following measures:

- Reorient or relocate the receiving antenna.
- Increase the separation between the equipment and receiver.
- Connect the equipment into an outlet on a circuit different from that to which the receiver is connected.
- Consult the dealer or an experienced radio/TV technician for help.

CAUTION:

Do not attempt to modify this product in any way without written authorization from LG Electronics U.S.A., Inc. Unauthorized modification could void the user's authority to operate this product.

COMPLIANCE:

The responsible party for this product's compliance is: LG Electronics U.S.A., Inc.
1000 Sylvan Avenue, Englewood Cliffs, NJ 07632, USA • Phone: 1-201-816-2000.

Marketed and Distributed in the United States by LG Electronics U.S.A., Inc.
2000 Millbrook Drive, Lincolnshire, IL 60069

HealthView™ is a registered trademark of Zenith Electronics Corporation

© Copyright 2007, LG Electronics U.S.A., Inc.

IMPORTANT SAFETY INSTRUCTIONS

SAFETY INSTRUCTIONS

Important safety instructions shall be provided with each apparatus. This information shall be given in a separate booklet or sheet, or be located before any operating instructions in an instruction for installation for use and supplied with the apparatus.

This information shall be given in a language acceptable to the country where the apparatus is intended to be used.

The important safety instructions shall be entitled "Important Safety Instructions". The following safety instructions shall be included where applicable, and, when used, shall be verbatim as follows. Additional safety information may be included by adding statements after the end of the following safety instruction list. At the manufacturer's option, a picture or drawing that illustrates the intent of a specific safety instruction may be placed immediately adjacent to that safety instruction:

- Read these instructions.
- Keep these instructions.
- Heed all warnings.
- Follow all instructions.

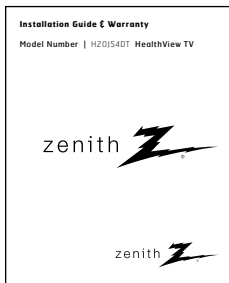

1. Do not use this apparatus near water.
2. Clean only with a dry cloth.
3. Do not block any ventilation openings. Install in accordance with the manufacturer's instructions.
4. Do not install near any heat sources such as radiators, heat registers,

stoves, or other apparatus (including amplifiers) that produce heat.

5. Do not defeat the safety purpose of the polarized or grounding-type plug. A polarized plug has two blades with one wider than the other. A grounding-type plug has two blades and a third grounding prong. The wide blade or the third prong are provided for your safety. If the provided plug does not fit into your outlet, consult an electrician for replacement of the obsolete outlet.
6. Protect the power cord from being walked on or pinched particularly at plugs, convenience receptacles, and the point where they exit from the apparatus.
7. Only use attachments/accessories specified by the manufacturer.

(Continued on next page)

IMPORTANT SAFETY INSTRUCTIONS

- Use only with the cart, stand, tripod, bracket, or table specified by the manufacturer, or sold with the apparatus. When a cart is used, use caution when moving the cart / apparatus combination to avoid injury from tip-over.



PORTABLE CART WARNING

- Unplug this apparatus during lightning storms or when unused for long periods of time.
- Refer all servicing to qualified service personnel. Servicing is required when the apparatus has been damaged in any way, such as power-supply cord or plug is damaged, liquid has been spilled or objects have fallen into the apparatus, the apparatus has been exposed to rain or moisture, does not operate normally, or has been dropped.
- CAUTION, Concerning the Power Cord:** Most appliances recommend they be placed upon a dedicated circuit; that is, a single outlet circuit which powers only that appliance and has no additional outlets or branch circuits. Check the specification page of this owner's manual to be certain.

Do not overload wall outlets. Overloaded wall outlets, loose or damaged wall outlets, extension cords, frayed power cords, or damaged or cracked wire insulation are dangerous. Any of these conditions could result in electric shock or fire. Periodically examine the cord of your appliance, and if its appearance indicates damage or deterioration, unplug it, discontinue use of the appliance, and have the cord replaced with an exact replacement part by an authorized servicer. Protect the power cord from physical or mechanical abuse, such as being twisted, kinked, pinched, closed in a door, or walked upon. Pay particular attention to plugs, wall outlets, and the point where the cord exits the appliance.
- Outdoor Use Marking:**
WARNING -To Reduce The Risk Of Fire Or Electric Shock, Do Not Expose This Appliance To Rain Or Moisture
- Wet Location Marking:** Apparatus shall not be exposed to dripping or splashing and no objects filled with liquids, such as vases, shall be placed on or over apparatus.

Table of Contents

Use this page as a reference for finding the pages or sections to go to and set up the TV's features for the end user

See the Master TV Setup on page 7

This TV functions differently than previous Zenith hospital sets. A Master TV setup must be created and then transferred to the internal TV controller with 2-5-5+Menu. This action will transfer all digital information and add important analog information to the TV controller.

Safety Warnings	2	Captions Unknown display	19
Important Safety Instructions	3 - 4	Ch Preview Menu	19
Table of Contents	5	Ghost Channel Display	19
TV Features Overview	6		
Master TV Setup	7		
		Step 3. Customize the TV's Features	
Step 1. TV Connections		Setup Menu	
TV, VCR, Cable Box and other Equipment Hookup		Auto Program: Select Antenna, or Cable service and start the channel search	20
Off Air Antenna	8	Add/Del/Blank	21
Cable Service	9	Channel Labels (Preset and Custom)	22 - 23
Off Air Antenna with VCR	10	Custom Labels for Digital Channels	24
Cable Service with VCR	11	Clock Setup (Auto/Manual)	25
		Timer Setup (On/Off Timers)	26
Additional Equipment Hookup		Captions: Analog-Digital (Setup Overview)	27
Composite Video/Monaural Audio Hook Up	12	Captions: Analog-Digital Menu Structures	28
External Speaker Hook Up	13	Audio Language	29
Pillow Speaker Connection & Setup	14 - 15	Language	30
		Alarm Menu	31
Step 2. TV Reception Set Up & Channel Search		Video Menu	32
Installer/User Remote Control	16	SAP: Digital Audio Program Selection	33
Installing Batteries in Remote Control	17	Parental Control Menu	34 - 37
Front Panel Controls	17	Channel Banks Setup	38 - 39 - 40
AC Power Cord	17		
		Installer Menus	41 - 50
On-Screen Menus/Displays Overview	18	Using the Quickset II Clone Programmer	51 - 54
Other Menus and On-Screen Displays		Clone Programmer Troubleshooting	54
Sleep Timer Menu	19	Troubleshooting	55 - 57
Channel/Time/Audio Display	19	Maintenance	57
Digital CC Menu	19	Glossary	58
Volume Display	19	Notes	59
Closed Captions Menu	19	Warranty	Back Cover

Purchase the Optional Installer/User Remote and Clone Programmer

To perform a normal installation set up, you need an installer's remote such as the remote shown on page 16, and the LT2000/LT2002 Quickset II Clone Programmer—shown and described on pages 51 - 54.

- The installer remote allows access to the Installer and User menus. The remote control shown herein is not included with the TV. However it can be purchased separately. See your Zenith/LG dealer.
- The Quickset II Clone Programmer is used to duplicate a Zenith TV's setup and install it on another identical Zenith TV. See your Zenith/LG Dealer.

Note: Design and specifications are subject to change without prior notice.

TV Features Overview

A brief overview of the features on this TV

Analog and Digital Tuners

This TV is equipped with both analog and digital tuners. The analog tuner is used for standard over-the-air antenna and cable type (CATV) sources. The digital tuner is capable of receiving over-the-air digital programming.

After running Auto Program on the TV, analog channels will appear numerically with Channel Up/Down and Digital Channels will appear numerically in the channel scan after either the highest/lowest analog channel or Aux source.

Installer Menu Default Items

Some items explained in this guide may have different default settings than those shown on the installer menu pages. As a result, those items may need to be reset based on the requirements of the institution.

Note: Do not delete Aux Channel. If only digital channels are available, the only user access to Parental Control will be the Aux channel.

Install a Two-way Signal Splitter?

If there is only one RF lead available, install a two-way splitter in order to be able to provide 75 ohm RF leads to both the Antenna/Cable and Digital/Antenna inputs on the TV connections panel.

Available Source Connections/Controls

- Antenna/Cable
- Digital/Antenna
- Composite Video with Monaural Audio
- External Speaker Output
- Pillow Speaker Control
- Front Panel Controls / Optional Remote Control Available

Features

Analog Menus

- Alarm Menu
- Captions/Text
- Language
- Parental Control
- Sleep Timer
- On/Off Timers
- Video Menu
- XDS Display

Digital Menus

- Digital Captions
- Digital Video
- Digital Language
- Digital Channels OSD

(Note: Even though an OSD indicates that digital features are available, they may not be present on the actual channel picture and sound signals.)

H20J54DT Master TV Setup

This TV requires a different setup than previous Zenith hospital sets. A Master TV setup must be created and then transferred to the internal TV controller with 2-5-5+Menu. The 2-5-5+Menu action adds to the TV controller important analog setup information and all digital information. (Please refer to the sections mentioned below for more detailed instructions.) Note: The TV is capable of storing in memory up to 140 digital broadcast and 125 analog channels.

Overview: Master TV Setup Procedure

Following are the steps necessary for setting up a Master TV. Once the Master TV is set up, it can be copied into the clone programmer so that the TV customized features can be transferred to other H20J54DT TVs. Note: After the Master TV setup has been successfully copied into the clone programmer, the TV can be connected to auxiliary equipment like a DVD Player, VCR and Pillow Speaker.

1. Connect antenna or cable service to both RF inputs on TV. Plug TV into a standard AC power outlet. Turn TV on and enter the Installer Menu.
 - a. If this is not a new TV, set Installer menu item **117-I RESET2DEFAULT**, to **1** and press ENTER. When the menu returns to 0, the TV is ready to be set up. Exit Installer menu.
 - b. Re-enter Installer menu and set Item **3-I BAND/AFC**.
 - **Broadcast** signal, set to **0** - **CATV** signal, set to **1**
 - c. Set item **28-I CH OVERRIDE** to **1** (Default).
 - d. Enable/disable all other installer menu items including Aux sources per your TV programming network requirements.
 - e. After all your particular required installer menu item settings have been set, press **ENTER** on the installer remote to remove and exit the Installer Menu.
2. Set up all TV menus/options and the features you want in the H20J54DT (Video, Audio, V-Chip menus etc. See TV Clonable options page 52.)
3. Run Auto Program (Search for all available channels*. All channels found analog and over-the-air digital will be entered into the TV's four channel banks.)
 - a. Add Channel Labels to Channel OSDs.
 - Add custom and preset channel labels. Add familiar network names like ABC, CBS, NBC etc.
 - b. Edit Channel Scan. In the Setup Menu, access the Channel Add/Del/Blk menu.
 - Review audio/video of "Found" channels. Determine channels to keep in your system.
 - Delete channels per your system requirements. (Maximum is 140 off-air digital + 125 analog.)
 - Review digital channel features. Add digital captions options. (Digital channels are available after Auto Program has completed the channel search.)
4. Verify Master TV Setup
At this point, edit the Channel Banks and verify that the channel lineup, channel names and custom labels etc. are correct.
 - Make sure that all TV features, both analog and digital, are set per your system requirements.
5. Enter Installer menu, then press 2-5-5 and **MENU** on the remote. This action adds information to the analog setup stored in the TV controller and Digital information; digital channels, digital features etc. (If 2-5-5 + Menu is not done, all digital and some important analog information will not be added to the master TV setup.)
 - Enter Installer menu and set item 28-I CH OVER RIDE to 0. This action locks the channel scan. Exit Installer menu.

After the preceding has been completed, the Master TV setup is ready to be copied to the LT2002 Clone Programmer, see Clone Programmer section.

* **Auto Program** finds channels that have a signal present and are actively being broadcast. Some broadcasters do not provide or broadcast a signal continuously. As a result, some DTV channels may not be found in the channel scan. If you know there is a DTV channel that was not found by Auto Program, run Auto Program again; when the DTV channel is actually sending out a program signal.

Hook Up an Off Air Antenna

Connect an over the air signal source to the TV

Over-the-Air Antenna

1 Locate the Antenna/Cable and Digital/Antenna jacks on the back of the TV.

2 Connect the RF antenna wires that run from the wall directly to the jacks, according to the connection diagram shown to the right.

 If you have a 75 ohm RF cable, then you don't need any adapters!

 A 300 to 75 ohm adapter is not included with the Zenith TV.

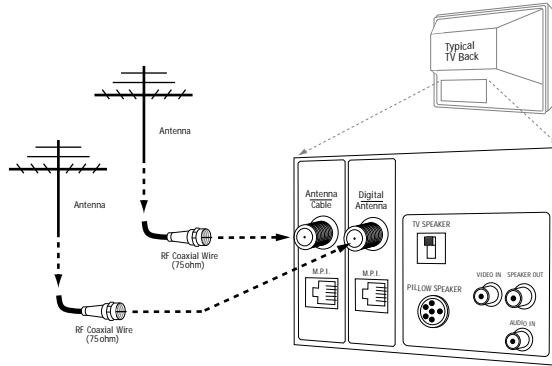

To get digital with only one RF antenna lead, install a 2-way signal splitter

1 If there is only one antenna lead available from the wall antenna jack, locate the Antenna/Cable and the Digital/Antenna jacks on the back of the TV.

2 Connect the antenna that runs from the wall directly to a 75 ohm 2-way signal splitter (not provided) according to the connection diagram shown to the right.

3 Connect the two antenna leads to the TV RF inputs: Antenna/Cable and Digital/Antenna. This will provide the same over-the-air signal to both the analog and digital RF inputs.

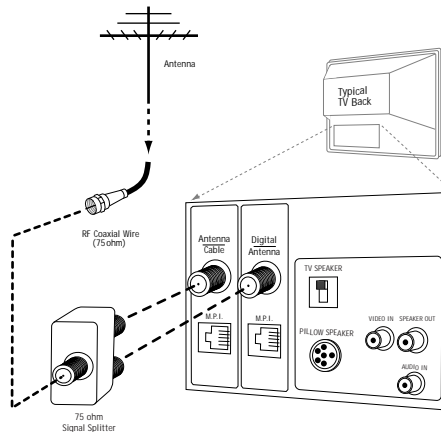

Mini Glossary

2-Way Splitter A device that provides two antenna signals from one antenna lead.

75 ohm RF Cable The wire that comes from an off-air antenna or cable service provider. Each end looks like a hex shaped nut with a wire sticking through the middle, and it screws onto the threaded jack on the back of the TV.

300 to 75 ohm Adapter (Not shown) A small device that connects a flat two-wire 300 ohm antenna to a 75 ohm RF jack. They are usually about an inch long with two screws on one end and a round opening with a wire sticking out on the other end.

Hook Up Cable Service (CATV)

Connect cable service to the TV

Cable Service

- 1** Locate the RF jacks on the back of the TV set.
- 2** Connect the CATV cable that runs from the wall to the Antenna/Cable RF jack as shown to the right.

 The TV digital tuner does not work with a Digital Cable signal source.

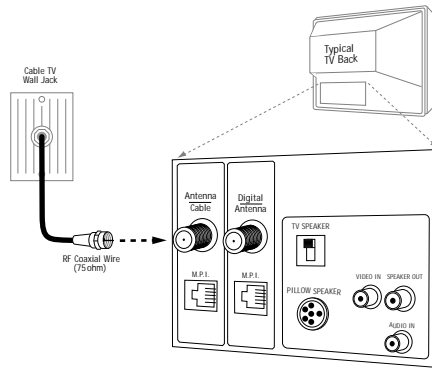

Cable Service with a Cable Box

- 1** Locate the Antenna/Cable in jack on the back of the TV set.
- 2** Connect the CATV cable that runs from the wall to the cable box and TV according to the connection diagram shown to the right.

 If you're using a cable box, tune the TV to channel 3 or 4 and use your cable box to change channels.

 If you're using a cable box, Auto Program might only find the channel your cable service is on (usually channel 3 or 4).

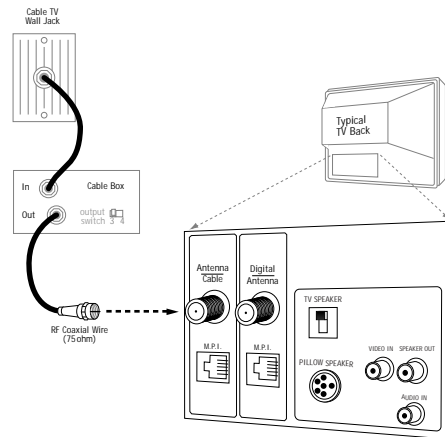



Hook Up an Off Air Antenna with VCR

Connect an over-the-air signal source to the VCR and TV

Over-the-Air Antenna with VCR

- 1** Locate the Antenna/Cable In jack on the back of the VCR.
- 2** Connect the antenna that runs from the wall jack directly to this jack, according to the connection diagram shown to the right. Connect a 75 ohm wire to the Digital Antenna input on the TV for digital programming.
- 3** Make the VCR to TV connections as indicated in the illustration.

 If you have a 75 ohm RF cable, then you don't need any adapters!

 A 300 to 75 ohm adapter is not included with the Zenith TV.

 No A/V cables are included with the TV.

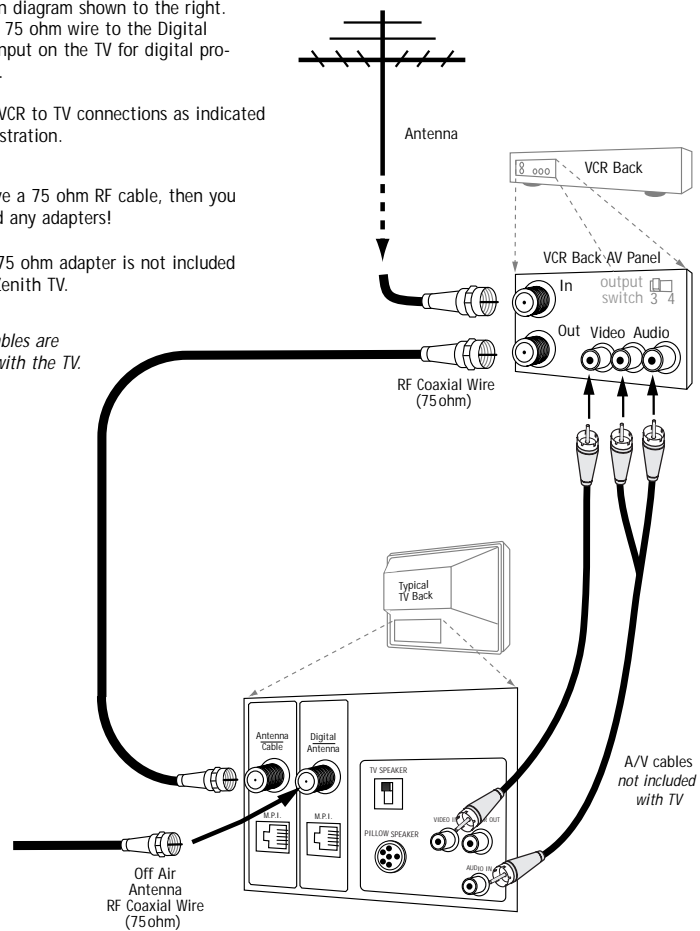



Hook Up a Cable Box with VCR

Connect a cable box and VCR to the TV

Cable Service with VCR

- 1** Locate the In jacks on the cable box and the VCR.
- 2** Connect a 75 ohm cable between the cable box wall jack and Cable In on the cable box.
- 3** Connect a 75 ohm cable from the Cable out jack on the cable box to the Ant In jack on the VCR.
- 4** Connect a 75 ohm cable between the VCR out jack on the VCR and the Antenna/Cable In jack on the TV.
- 5** Connect a 75 ohm wire to the Digital Antenna input on the TV to get digital programming.
- 6** Make the other VCR-TV connections as indicated in the illustration.

 For cable service without a cable box, connect a 75 ohm cable between the cable wall jack and the VCR In jack.

 No A/V cables are included with the TV.

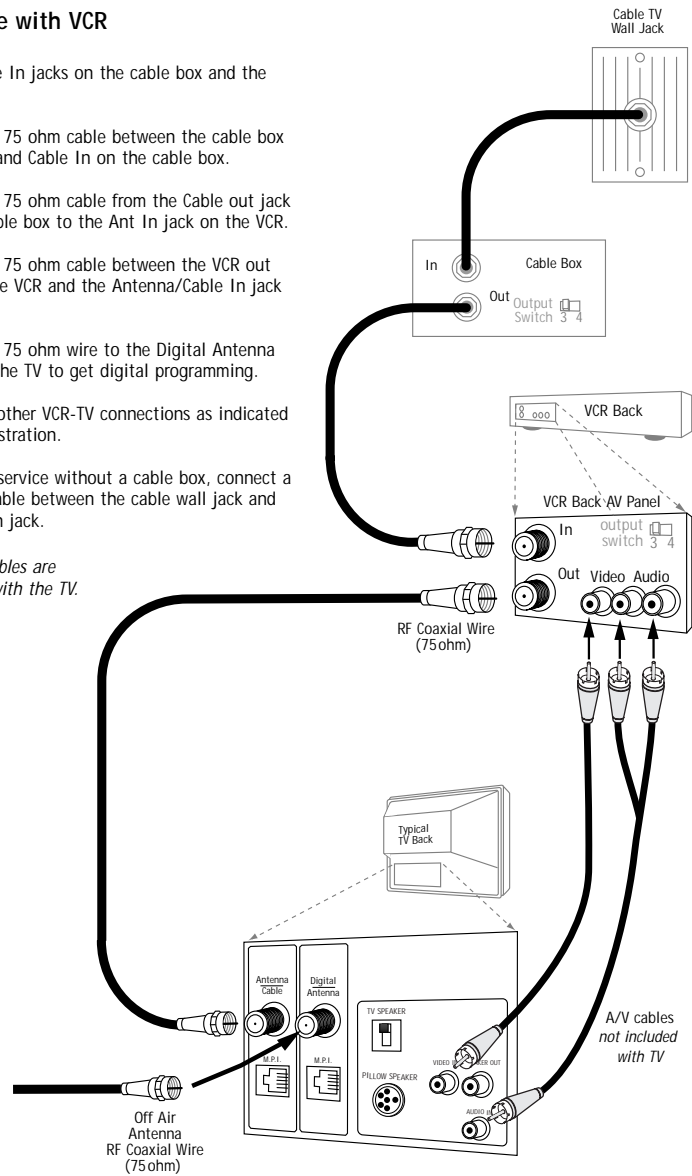

Hook Up Audio/Composite Video

Connect the TV to an audio/composite video source

Audio/Composite Video

- 1** Locate the audio/composite video input jacks on the TV.
- 2** Connect the audio/composite video input jacks to an audio/composite video device as shown in the illustration.

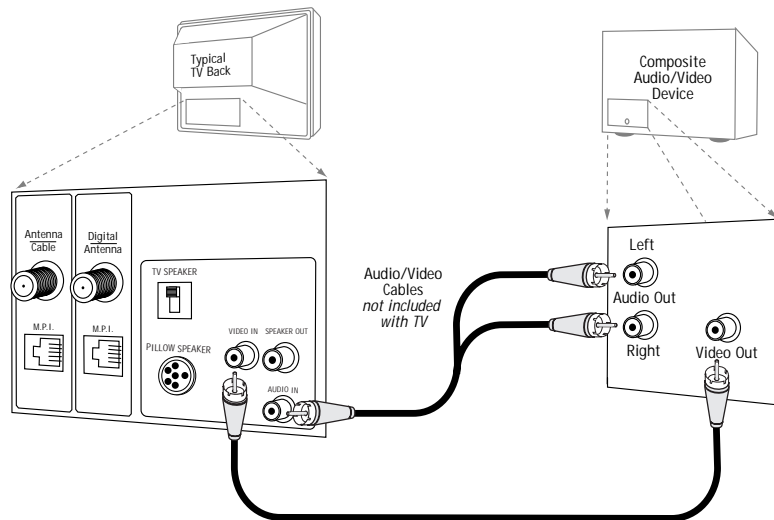

Hook Up an External Speaker

Connect the TV to an external speaker or amplifier

External Speaker

- 1** Locate the Matrix Out jack on the back of the TV.
- 2** Connect the Matrix Out jack to an external speaker or audio amplifier as indicated in the illustration.

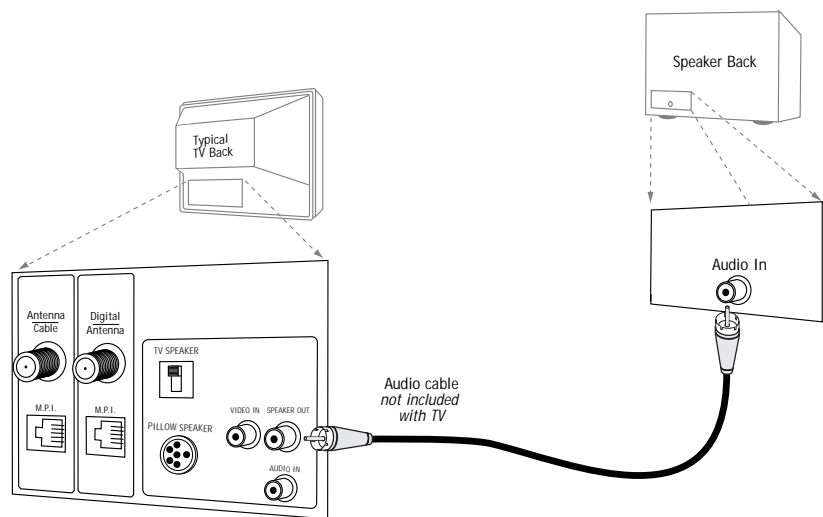

Pillow Speaker Connection & Setup

Pillow speaker is not included with the HealthView TV

Pillow Speaker Setup

- 1** Locate the Pillow Speaker output jack on the back of the HealthView TV.
- 2** Connect an accessory pillow speaker or wired remote control unit to this 6-pin jack.
- 3** Connect the pillow speaker as shown in the illustration.
- 4** Set the Pillow Speaker switch to Pillow Speaker setting.
Note: Once the switch is set to Pillow Speaker, no audio will be heard from the TV speakers.

Use a pillow speaker by Curbell, Model A-16455-02 or other UL recognized pendant control bearing the warning: "Risk of fire if used in oxygen enriched atmosphere. Keep pendant control away from oxygen equipment."

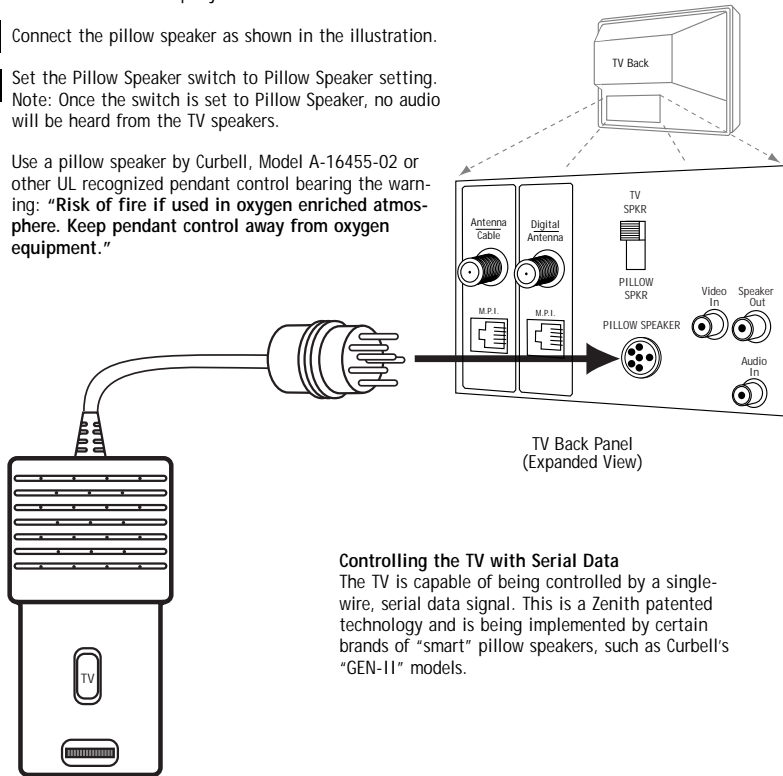

Controlling the TV with Serial Data

The TV is capable of being controlled by a single-wire, serial data signal. This is a Zenith patented technology and is being implemented by certain brands of "smart" pillow speakers, such as Curbell's "GEN-II" models.

Pillow Speaker Setup

Connect a pillow speaker to the TV

Pillow Speaker Control

Pillow Speaker Interface

This connector furnishes three control lines and an audio output. A patient-pendant remote control, or entertainment audio and nurse call system may be connected here. All lines are isolated from the AC power line and earth ground. (Opto-isolators isolate the control lines, and a transformer isolates the audio. There are no relays or inductive components in the control lines.)

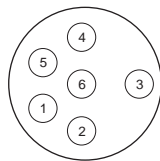

- 1 |————— TV ON/OFF
- 2 |————— OPEN
- 3 |————— CHAN UP/DATA IN
- 4 |————— COMMON
- 5 |————— AUDIO OUT
- 6 |————— CHAN DOWN

Pin No.	Purpose
1	External TV On/Off switch.
2	(Not used.)
3	External Channel Up switch or Data in.
4	Common connection for control, data, and audio output. Impedance to earth ground is a 10-meg resistor in parallel with a 1100 pf capacitor.
5	Isolated audio output. Nominal 14-ohm source impedance with short circuit protection. Intended for a pillow speaker with a low-impedance pad-type volume control.
6	External Channel Down switch.

Controlling the TV with Mechanical Switches

Pin 4 (common) is momentarily connected to pin 1, 3, or 6 via push-action switches to control On/Off and Channel Up/Down. These pins are at +13 volts DC (when measured from pin 4) with the switches open. Current draw is 8 mA when a switch is closed. (This operation is identical to previous Zenith models using the 5-Wire Interface except that only +7 volts DC was supplied and current draw was only 2.5 mA.)

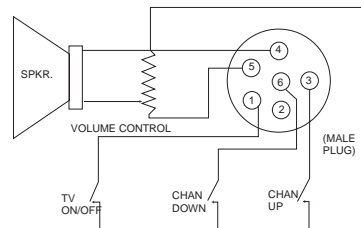

Optional Installer/User Remote Control

Keys descriptions and functions for the optional remote

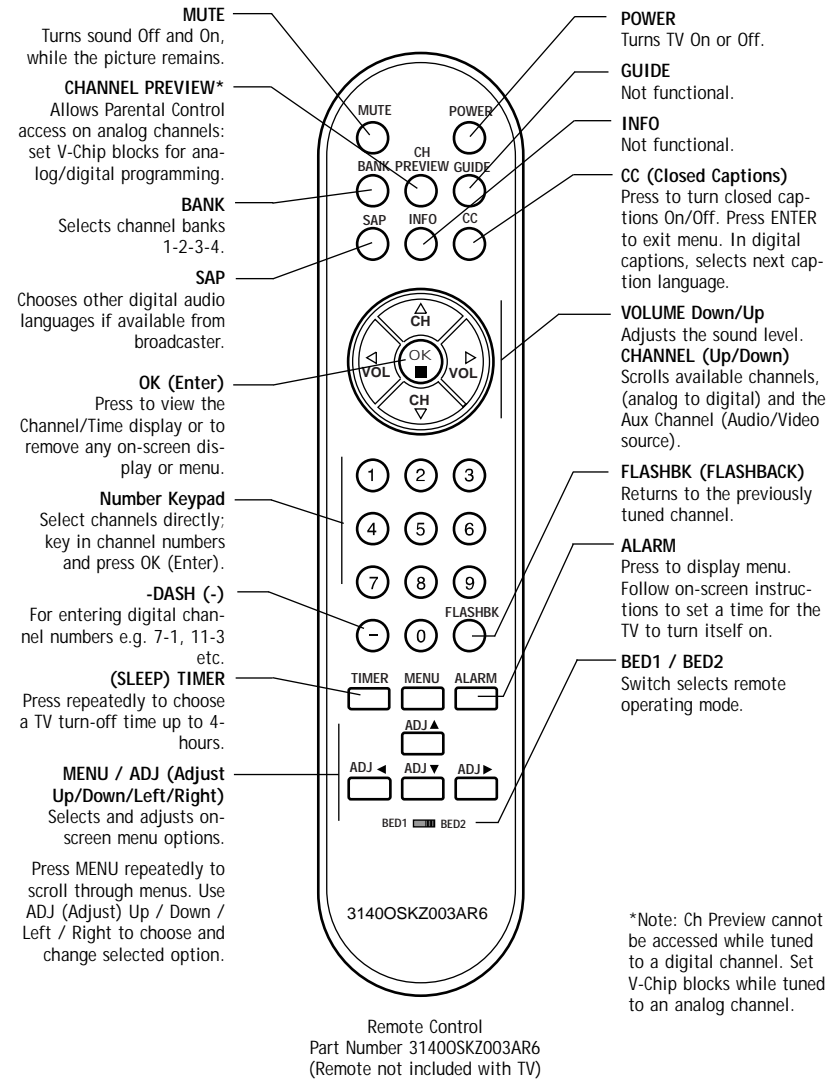

Audio Languages: Availability of audio languages are determined only by each broadcaster and may not be available on all digital programs.

Front Panel Controls

Using the front panel controls to operate the TV

- A** **Power**
Turns TV on and off.
- B** **Channel (Down/Up)**
Chooses next available channel.
- C** **Volume (Down/Up)**
Decreases/increases sound level.
- D** **CC (Captions/Text)**
Turns selected caption/text option On and Off. (Depending on TV captions setup.)

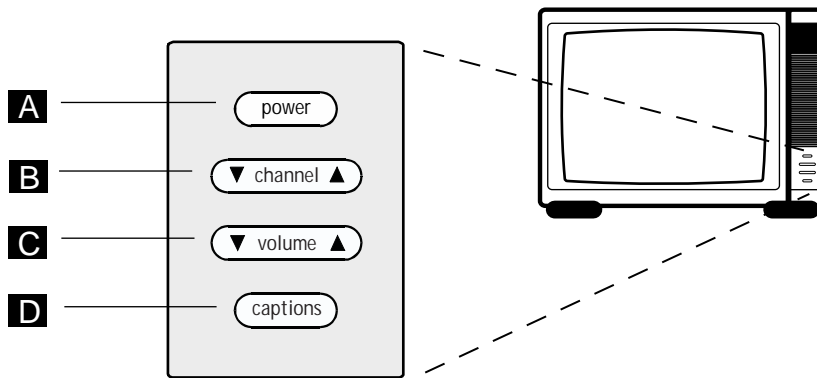

Install Batteries into Remote Control

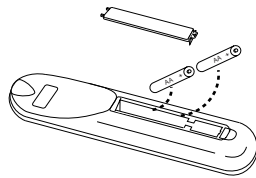

Remove the back of the remote control and install two high-quality AA batteries. Match "+" with "+" and "-" with "-".

(Remote not included with TV)

Plug TV into AC Power Outlet

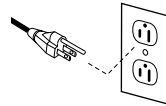

After all connections have been made, plug the TV and all system

equipment into power sources as applicable. This TV is designed to operate on standard current 120-volt 60 Hertz AC power.

On-Screen Menus/Displays Overview

Descriptions of the menus and on-screen status displays

Using MENU and the other keys indicated on the optional Installer's remote, the installer can access the menus/displays described below.

On-Screen Menus

Setup Menu		Adjusts the basic characteristics of the TV.
Auto Program	20	Automatically finds and stores active channels to scroll through using Channel Up/Down.
Add/Del/Blnk	21	Manually pick and choose which active channels will appear when using Channel Up/Down.
Channel Labels	22	Label the channels with their network names (ABC, CBS, HBO, etc.).
Clock Set	25	Sets the time on the TV.
Timer	26	Sets the TV's automatic turn On/Off times.
Captions	27	Analog-Digital Captions (Caption/Text) Setup Overview.
Captions Menus	28	Analog-Digital Captions Menus Structures.
Audio Language	29	Sets the digital audio language, if available on program.
Language	30	Chooses the language the on-screen menus will appear in.
Alarm Menu	31	Set a time for the TV to turn itself on.
Video Menu	32	Customizes the picture. The options are: Contrast, Brightness, Color, Tint, Sharpness, Picture Pref, and Aspect Ratio (Aspect Ratio is only for Digital Channels).
Audio Language Menu	33	Selects available Digital audio languages.
Parental Control Menu	34	Allows user to block program content or the A/V sources for up to 99 hours, with the use of a password.

Other Menus and On-Screen Displays

Volume	19	Shows current sound level setting; press VOLUME Up/Down to activate.
Channel/Time	19	Shows the current time, channel, video or mute, and XDS info; press OK to activate.
Ch Preview	19	Displays the available channels list; press CH PREVIEW. (Only Analog Channels are displayed not Digital).
Captions/Text	19	Turns selected Caption/Text option On and Off; press CC to activate.
Sleep Timer	19	Sets the time the TV will turn Off.
Ghost Channel	19	Shows the current channel number in red scrolling down the screen. Refer to Installer menu to turn Off.
Alarm	19	Sets a time for the TV to automatically turn itself On.

Other Menus and On-Screen Displays

Press the remote keys indicated below to access these menus and displays

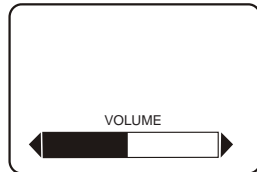

Volume Display
Press VOLUME. Shows current sound level.

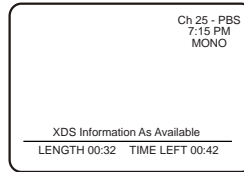

Channel/Time/Audio Display
Press ENTER. Shows selected channel or source, time if the clock is set, incoming audio signal, and XDS* info if available on program. For XDS wait 5 seconds and press ENTER.

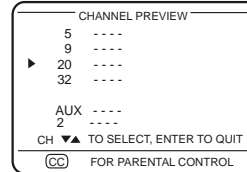

Ch Preview Menu
Press CH PREVIEW*. Shows list of TV Analog Channels, AUX source, and provides access to the Parental Control menu.

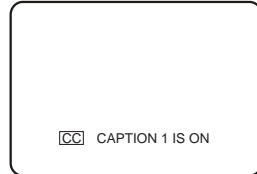

Closed Captions Menu
Press CC. Turns selected option on or off for both analog and digital captions. See Caption / Text pages to set up options.

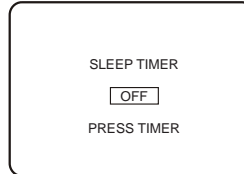

Sleep Timer Menu
Press TIMER. Shows remaining time before TV turns itself off. Select a preset turn-off time from 10 minutes up to 4 hours.



Ghost Channel Display
Channel number appears in red on the right side of the screen and slowly scrolls downward. To disable the Ghost Channel, see Installers menu.

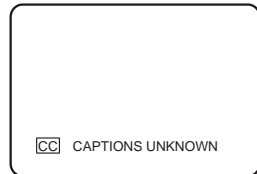

Captions Unknown Display
Press CC, if captions are not known, this display appears.

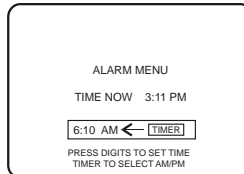

Alarm Menu
Press Alarm. Sets a time for the TV to automatically turn itself On.

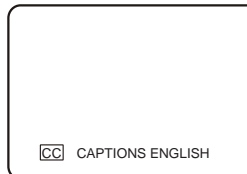

Digital Captions Menu
Press CC to scroll each digital captions language, if available and to turn captions on/off.

*Not available on digital channels.

Digital Channels On-Screen Display



Press ENTER twice to see the on-screen display for digital channels. Reveals channel number and program details: Title, day, time, languages available, video formats available, closed captions options, etc.

News and local programming	4:00 PM	5:50 PM	DTV 66-1
Thu Jan 19, 2007	4:00 PM	6:00 PM	Dolby Digital HD
Multi-lingual	16:9	1080i	TV-PG

Auto Program (Channel Search)

Note: Use item 3-I Band/AFC in Installer menu to select proper analog tuning band (0=CATV, 1=Broadcast etc.) before running Auto Program.

- 1** Using the optional Installer's remote control, press POWER to turn the TV on.
- 2** Press MENU repeatedly until the Setup menu appears.
- 3** Use Up or Down ADJ on the remote control to highlight Auto Program on the menu.
- 4** Press the Right or Left ADJ arrow to begin the Channel Search.
- 5** Press OK when the channel search is complete. This is when the two progress bars are filled and the message "COMPLETED SUCCESSFULLY" appears on the screen.

-  Auto Program finds channels being received by the TV's analog and digital tuners.
-  Cable will not work unless you subscribe to a cable service.
-  After the channel search is complete, use the features on the following pages to: Add/Delete/Blank channels. Include channel labels, so that they will appear on the channel / time display. Choose from the preset label selections for analog and create your own labels for digital channels.

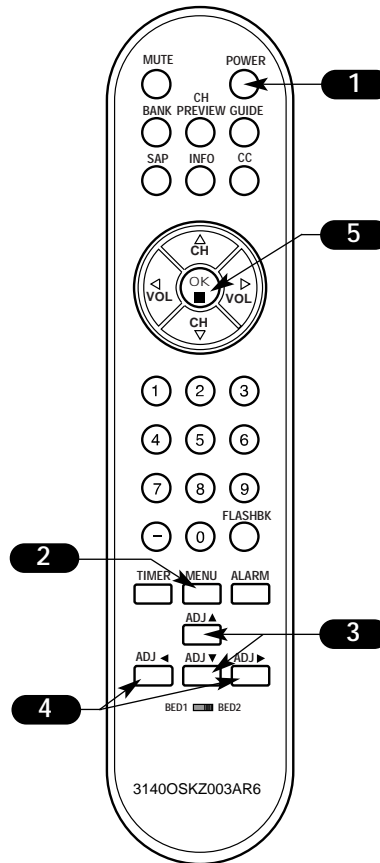
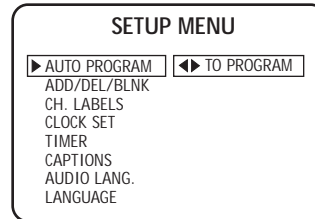

Add/Delete/Blank Feature

Fine-tune the channel selection list by blanking certain channels and deleting other unwanted channels.

Note: TV can store in memory 140 broadcast digital and 125 analog channels

- 1** Use MENU key on optional Installer's remote to access the Setup menu.
- 2** Use the Up or Down ADJ key to highlight the Add/Del/Blnk option.
- 3** Using either the NUMBER keypad and OK or the Channel Up/Down arrow on the remote, select a channel.
(If adding a deleted channel, use the NUMBER keypad and OK.)
- 4** Use the Right or Left ADJ arrow to specify whether the channel is to be Added, Deleted or Blank.
- 5** To continue, select another channel and repeat Step 4. When you are finished, press OK to remove menu.

 Adding Aux, VCR3, VCR4, to the Channel Preview List. Go to the Setup menu, select the Add/Del/Blnk option. Use Channel Up/Down to select Ch 126-0 for VCR3 (Ch 127-0 for VCR4) and choose Added.

Note: If the option was turned off in the Service menu, you will have to reinstate it before it can appear as an option in the Channel Preview list.

Note: You can specify Add, Delete or Blank for VCR3, VCR4, and Aux. Caution: If you delete Ch 3-0, VCR3 (Ch 126-0) is also deleted. If you delete Ch 4-0, VCR4 (Ch 127-0) is also deleted and vice versa.

 Channel scanning up: Analog Channels, Digital Channels, VCR3, VCR4 and Aux. Use Channel Up to scan all channels, Ch Preview for analog only. Channel scanning down, reverse order of above.

 If you delete a channel, it isn't gone for good. Just select it using the NUMBER keypad on the remote, or add it later. Set Installer menu item 28-1 Ch Over ride to 1 to be able to re-add channel to channel scan in memory.

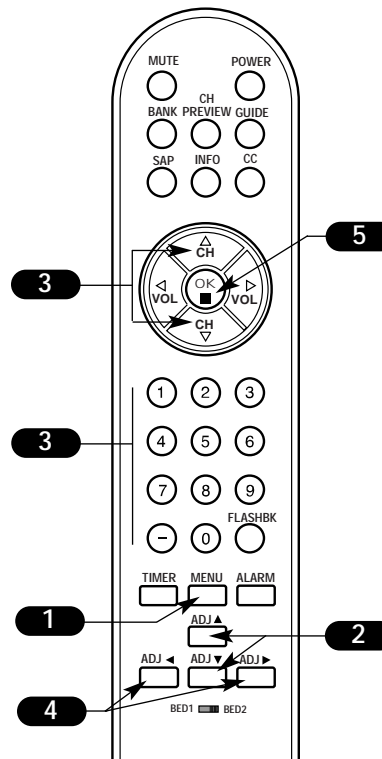
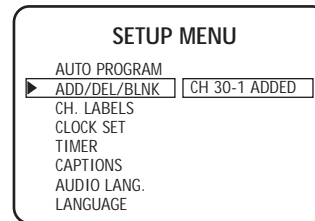

Mini Glossary



- ADDED** Adds previously deleted channels to the list that the user can scroll through using Channel Up/Down.
- DELETED** Removes channels for one reason or another from the channel scan list available using Channel Up/Down.
- BLANK** Deletes the video but retains the audio, if present on channel.

Setting Preset Analog Channel Labels

Selecting channel names from the preset Channel Labels

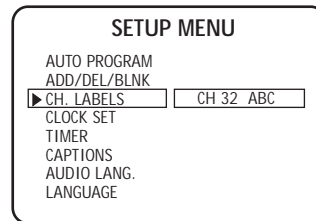
- 1** Using either the NUMBER keypad or the Channel Up/Down arrows on the optional Installer's remote, select an analog channel.
- 2** Press MENU repeatedly on the optional Installer's remote until the Setup menu appears.
- 3** Choose the Ch Labels option using the Up or Down ADJ arrow.
- 4** Press either the Right or Left ADJ arrow repeatedly to pick the label you want from the available selections; such as A & E.
- 5** To continue channel labeling, select another channel or if you are finished, press OK to remove menu.



-  Press and hold down ADJ left/right for faster label scrolling.
-  Some channels already provide a channel label which is included with the broadcast signal.
-  Labeling the channels helps identify which familiar nationwide networks are available. i.e., A & E - Arts and Entertainment, CNN -News, ESPN - Sports, HBO - Movies and so on...

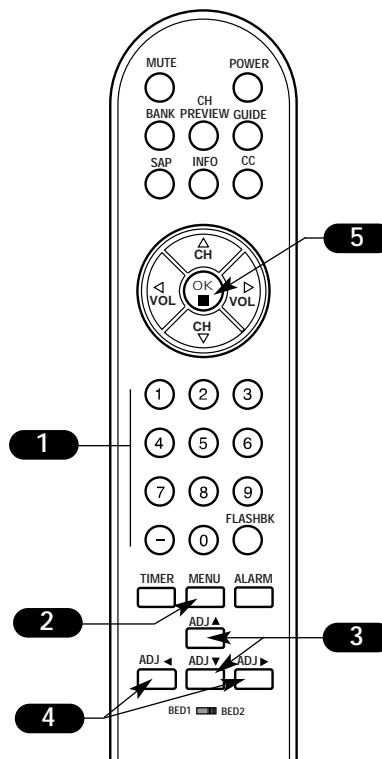

Mini Glossary

- - - - The 4 dashes will allow a channel label to appear; if one is provided by the broadcaster.
- NONE Prevents any channel label from appearing.

Analog Preset Channel Labels



Typical Analog preset Channel Label options

A&E	DISC	MAX	TMC
ABC	E!	ME/U	TNN
ACTS	ENC	MMT	TNT
ADC	ESPN	MTV	TRAV
AMC	ESP2	NBC	TSN
BCC	ET	NICK	TVA
BET	EWTN	NOS	TWC
BRAV	FAM	PBS	UPN
CA	FNN	PLAY	USA
CBC	FOX	PTL	UC
CBN	F&V	QVC	VCR
CBS	FX	RDS	VH-1
CMTV	GALA	REQ	VISN
CNBC	HBO	SC	VJN
CNN	HN	SCFI	WB
COM	HSE	SHOW	WGN
CSPN	HSN	SIN	WTBS
CSP2	IC	TBS	WWOR
CTN	INSP	TBN	YTV
CTV	JCN	TELE	
DIS	LIFE	TLC	

Setting Custom Labels for Digital Channels

Setting channel names for Channel Labels

- 1** Using either the NUMBER keypad or the Channel Up/Down arrows on the optional Installer's remote, select a digital channel.
- 2** Press MENU repeatedly on the optional Installer's remote until the Setup menu appears.
- 3** Choose the Ch Labels option using the Up or Down ADJ arrow.
- 4** Press Vol right to select the first character space.
- 5** Use Ch Up/Down to select the character. Continue adding characters to the label with Vol/Ch keys.
- 6** To continue channel labeling, select another channel or if you are finished, press OK to remove menu.

-  **Press and hold down Ch Up/Down for faster character scrolling.**
-  Some channels already provide a channel label which is included with the broadcast signal.
-  Use custom channel labels to identify your unique channel line up.

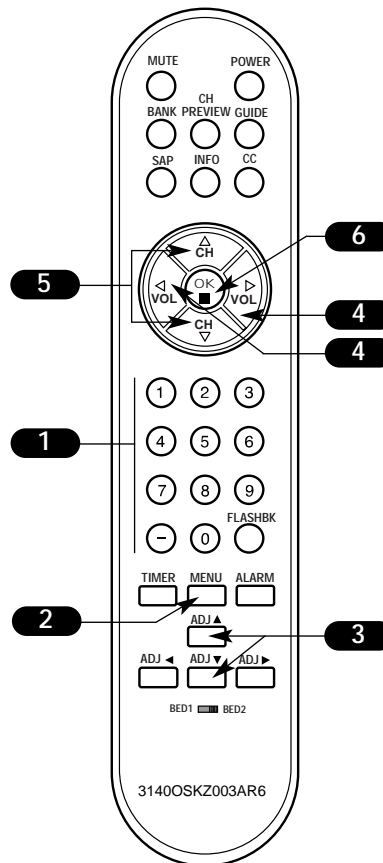
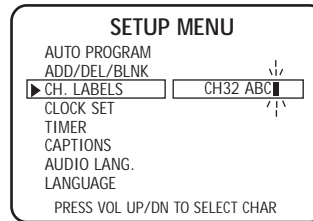

Clock Setup (Auto or Manual)

Have the TV set the clock time or use Manual Clock Set

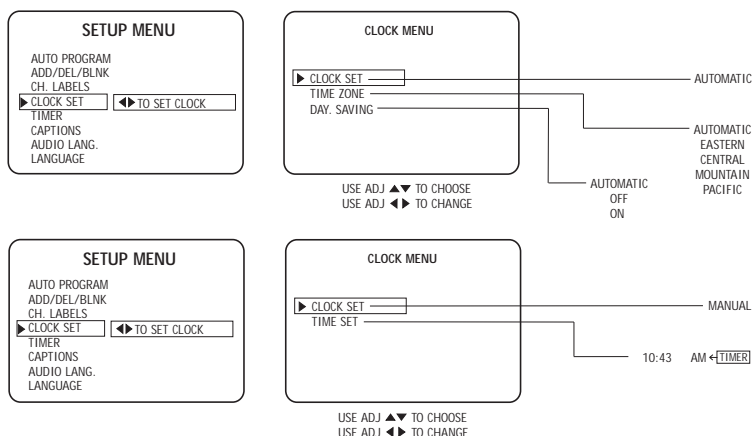

Clock Auto/Manual Operating Modes Setup

1 On the optional Installer's remote, use MENU and the ADJ Up/Down/Left/Right arrows to choose and set up the Clock menu options.

2 Use the number keypad, or the Left/Right ADJ arrows, to set the time. Use TIMER to set AM/PM.

Clock Set Automatic: TV automatically sets the time.

Time Zone: Installer can choose the time zone or have the TV set it automatically.

Note: If analog and digital times on Ch-Time OSDs are not the same time, select your local time zone. Power TV Off/On, tune in your local analog PBS channel to reset clock.

Day Savings: Installer can choose to have daylight savings adjust the clock time one hour, or have the TV adjust it automatically.

Manual: Installer sets the time on the clock.

- Press OK repeatedly to remove menus.



The clock can also be set using 24 hour "military time." For p.m. settings add 1200. For example, to set 6:30 p.m., add 1200 to 630, = enter 1830.



For Auto Clock Set to work, the TV must be tuned to a local analog (not digital) PBS station. If the TV does not set the time, set the clock time manually.



Clock time can be set using either the number keypad or the Left/Right ADJ arrows. Use TIMER to set AM/PM.

Note: Analog and digital times shown on Ch-Time OSDs may vary by a few minutes.

Mini Glossary

TIME	A four-digit figure broken down into hours and minutes, used for entering the time when setting the clock or programming timers.
HOURS	First two digits that are entered when setting the clock or programming timers.
MINUTES	The last two digits that are entered when setting the clock or programming timers.
TIMER	Chooses AM or PM when setting the clock.

On-Off Timers Setup

Set up On/Off Timers *Note: On/Off Timers operate independently*

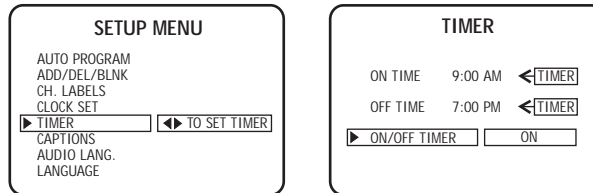

- 1** On the optional Installer's remote, press MENU repeatedly until the Setup menu appears.
- 2** Use Up or Down ADJ to highlight the Timer option then press the Left or Right ADJ arrow.
- 3** Use Up or Down ADJ to choose an option. Use the number keypad and/or the Left or Right ADJ arrow to enter the times. Use the TIMER key to set AM/PM.

Your options are:

- On Time: Sets a time that the TV will turn itself On each day.
- Off Time: Sets a time that the TV will turn itself Off each day.
- On/Off Timer: Enables or disables the On/Off Timer functions. (The On/Off Timer can be disabled but the settings will be retained.)

- 4** Press OK to remove menu.

- The clock must be set before the Timers will function.
- The Off Timer can be used to turn the TV off at the preset time.
- The On Timer does not have to be set to use the Off Timer feature.

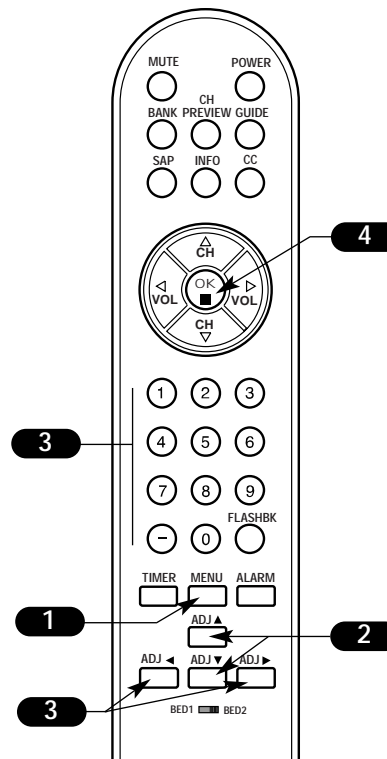

Mini Glossary

- TIME** A four-digit figure broken down into hours and minutes, used for entering the time when setting the clock or programming timers.
- HOURS** First two digits entered when setting the clock or programming timers 01, 02, 10 etc.
- MINUTES** The last two digits entered when setting the clock or programming timers XX:05 etc.
- TIMER** Chooses AM or PM when setting the time.

Captions: Analog-Digital (Caption/Text) Setup Overview

Set up Closed Caption/Text options for the end user

Analog-Digital Closed Captions/Text Overview, End-user Setup

The caption/text feature is designed to be available to the end user on either an analog or digital channel. For the end user to get analog captions, all the user needs to do is press CC on the remote and select On - - same for digital channels, select On and pick a language. The installer can elect to make analog and digital captions available by turning captions on. The installer sets the caption options on both analog and digital menus. To set up digital captions, the installer must tune in a channel with digital captions. Use 'Set by Program' to show digital captions that are similar in appearance to analog captions e.g. white text on black.

End User Captions Operation

If both analog and digital captions are turned on by the installer, analog and digital captions will be available to the end user. If digital captions are not available on a digital channel and analog captions are, then analog captions appear.

Analog Closed Captions/Text Operating Modes Setup

On the optional Installer's remote, use MENU and ADJ (Up/Down/Left/Right) to choose Closed Captions / Text mode and set up other options for the end user.

Quick/Mute When CC is pressed: End user can only turn Captions On/Off.
(CC on Mute is not available.)
(If locked, caption type is retained with Power On/Off.)

Standard When CC is pressed: End user can choose a captions type.
(If locked, type is retained with Power On/Off.)

Press OK to remove menus.

Digital Captions Operating Modes Setup

On the optional Installer's remote, use MENU and ADJ (Up/Down/Left/Right) arrows to configure the Digital Captions appearance.

Language Selects the default Digital Caption Language.

Style:

Set By Program Captions appear white text on black, similar to analog captions.

Custom The installer configures the Digital Captions appearance, see the next page for the digital captions appearance options available.

Press OK to remove menus.



Standard closed captioning is available using the Caption 1 option.

Caption/Text are features which allow the TV to display the closed caption and/or text options if made available by the broadcaster.



Availability and functionality of Caption/Text options are determined only by each broadcaster and may not be available on every program.

Captions: Analog-Digital Menu Structures

Review Analog and Digital Captions options available
 Note: Digital captions are only available on some digital channels.

Analog Captions Menu Structure

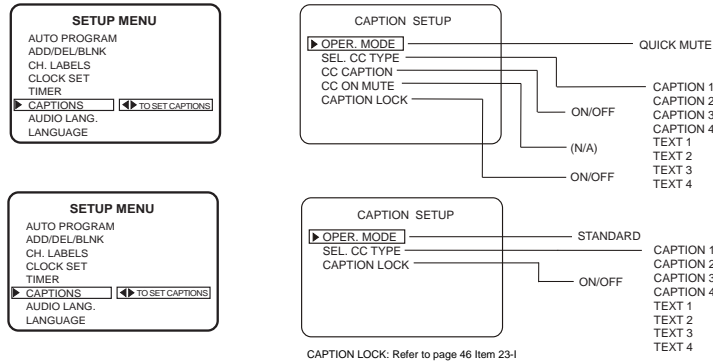

Availability and functionality of Analog Captions are determined only by each broadcaster and may not be available on every program.

Digital Captions Menu Structure

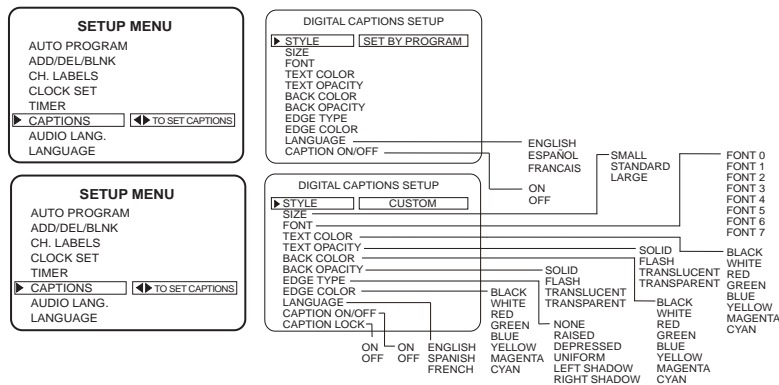

Availability and functionality of Digital Captions are determined only by each broadcaster and may not be available on every program.

Mini Glossary

- CAPTIONS** The term for the words that scroll across the bottom of your TV screen; usually the audio portion of the program provided for the hearing impaired.
- TEXT** The term for the words that appear in a large black frame and almost cover the entire screen; usually messages provided by the broadcaster. (Only available on analog channels.)

Audio Language for Digital Channels

Choose English, Spanish, (Español) or French (Français) for Digital channels
 Default Audio: If you select an alternate language, the TV tries to find it. If the alternate language is not available, the TV audio will be the default audio from the program. Typically, if you select Spanish and it is not available, English will be heard.

- 1** On the optional Installer's remote, press MENU repeatedly until the Setup menu appears.
- 2** Use Up or Down ADJ arrow on the remote control to highlight the Audio Lang. option on the menu.
- 3** Use the Left or Right ADJ arrow to choose one of the following options:
 - English
 - Spanish
 - French
- 4** Press OK to remove menu.

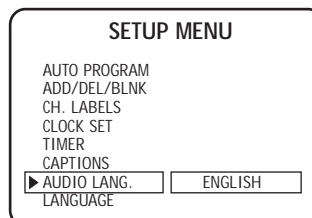

Notes: The broadcaster has control of any additional languages available. If a program's display shows another language is being broadcast, select that language. **If however, no additional audio language is being included on the program's signal, no audio will be heard.** This condition is not the fault of the TV. If no other language is being broadcast, the TV can't play it. To hear audio, you must select an active language.

 Alternate audio languages are selectable on the menu by the Installer. When another language is selected, it will not appear on the current channel. Select another channel first, then go back to the desired channel. The newly-selected language will be heard, if on the program.

 On pillow speakers with a Menu key, patient can access other audio languages, if available on the program.

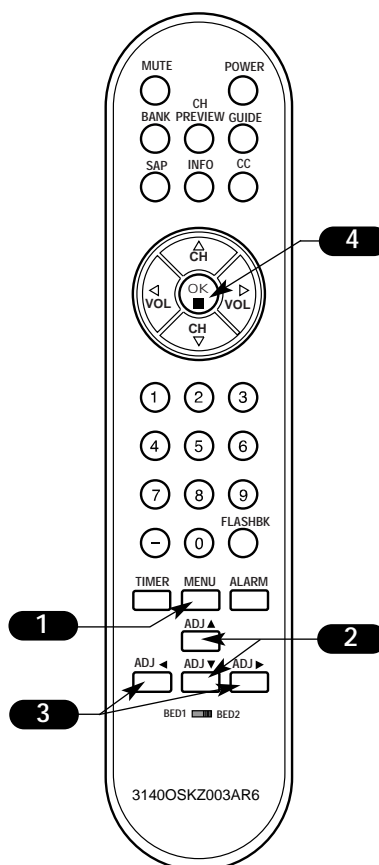

Language for the On-Screen Menus

Choose English, Spanish, (Español) or French (Français)
for the on-screen menus

1 On the optional Installer's remote, press MENU repeatedly until the Setup menu appears.

2 Use Up or Down ADJ arrow on the remote control to highlight the Language option on the menu.

3 Use the Left or Right ADJ arrow to choose one of the following options:

- English
- Spanish (Español)
- French (Français)

4 Press OK to remove menu.

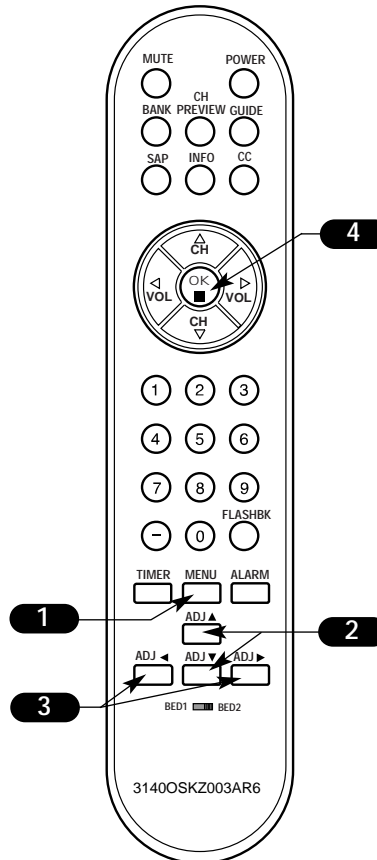
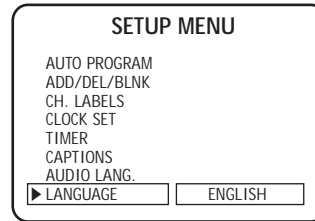

Alarm Menu

Use the Alarm menu to set a time for the TV to automatically turn itself On

- 1** Press Alarm on the optional remote control.
- 2** Using the NUMBER keypad, set the time you want the TV to turn On. For example, to set 7:30 AM, key in 0, 7, 3, 0.
- 3** Use TIMER to choose AM or PM, as shown on the menu.
- 4** Press OK to remove menu from screen.

 The alarm will only work if the TV is turned Off.

 Be sure the TV's internal clock is set to the current time, so that the wake up alarm will work properly.

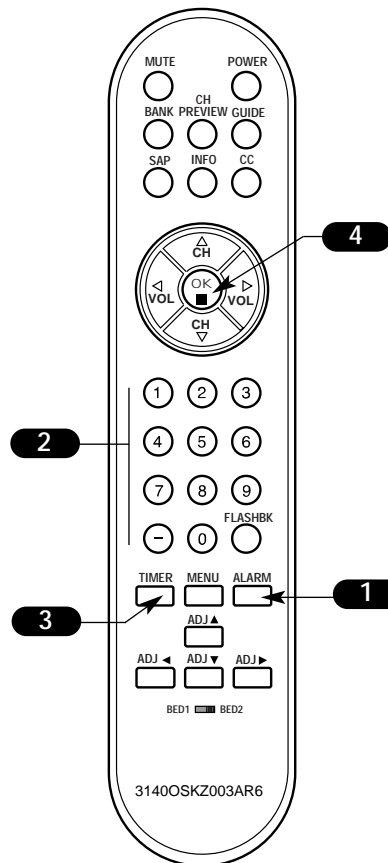
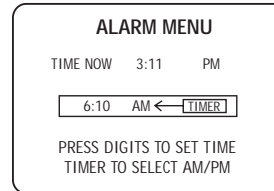

Video Menu

Use the Video Menu to customize the picture's appearance

1 On the optional installer's remote, press the MENU key repeatedly until the Video menu appears. Your options are:

- Contrast: Adjusts the level of difference between white and black in the TV picture. The more contrast, the brighter the picture appears.
- Brightness: Increases or decreases amount of white in the TV picture.
- Color: Adjusts levels of all colors in the TV picture.
- Tint: Adjusts the relative amounts of red and green in the picture.
- Sharpness: Raises or lowers the definition of the picture. The lower the level, the softer the image will appear.

- Aspect Ratio: (Digital channels) Modifies height and width ratio of the picture; when available from the broadcaster. Aspect Ratio options: Zoom, Full Screen, Letter box.

- Picture Preference: Choose either Custom or Preset:

Custom = Allows you to set the picture appearance to your requirements.

Preset = Resets all the above options back to their original, factory-set levels.

2 Use Up or Down ADJ on the remote control to choose Contrast on the menu.

3 Use the Left or Right ADJ arrow to change or adjust the contrast level as required.

4 Press OK, to remove the menu, or repeat from Step 2 to adjust other Video menu options.

 Choose the Preset option in Picture Preference to quickly reset the Video menu options back to their original default values.

 Aspect Ratio is only for Digital Channels. The availability of Aspect Ratios are determined only by the broadcaster and may not be available on all programs.

 Aspect Ratio options are not available for 480i (SD) digital channels.

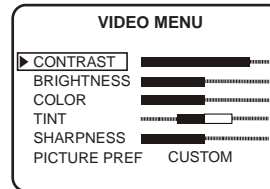

Analog Channel Display

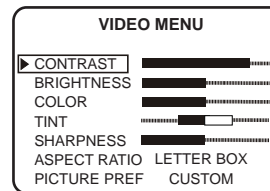

Digital Channel Display

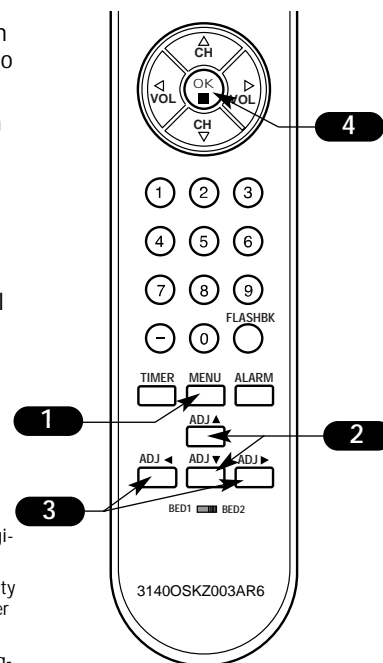

SAP: Additional Digital Audio Program Selection

SAP can be used to select other additional digital audio programs, if available

News and local programming	5:50 PM	DTV 66-1
Thu Jan 19, 2007	4:00 PM <input type="checkbox"/> 6:00 PM	Dolby Digital HD
Multi-lingual	16:9 1080i TV-PG	

Indicates the broadcast may have additional audio programs available.

Note: The broadcaster has control of any additional audio programs available. If a program display shows another audio is being broadcast, use the SAP button to select that audio. **If however, no other audio is present on the program's signal, no other audio will be heard.** This condition is not the fault of the TV. If no other audio is being broadcast, the TV can't play it. To hear audio, you must select an active language.

- 1 On the optional Installer's remote, press SAP repeatedly to scroll the available digital audio tracks on the selected channel.
 - As mentioned above, even if another audio program is indicated as being available, if it is not being added to the program signal, no audio will be heard for that additional program.

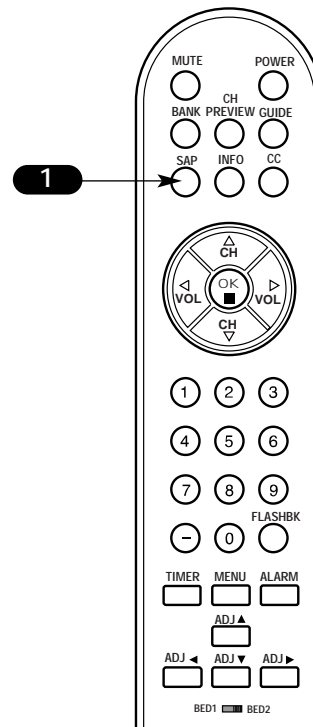

Mini Glossary

SAP On digital channels, occasionally other languages like Spanish may be included on the program signal.

Parental Control Menu Overview

Use V-Chip to restrict undesirable programming

This feature can "block" undesirable programming from appearing on the TV. Set restrictions using Age Block for all programming, TV and movies.

Overview

Parental Control offers the user a wide variety of options and settings that restrict or "block" the programming that can appear on the TV. Parental Control allows the user the capability of defining which program rating they consider acceptable, to the younger or more sensitive viewer. It can be preset and turned either on or off by the user who specifies a secret 4-number code, the password. General audience and children viewer blocks can both be programmed into the TV's memory. Viewer ratings are specified for both TV and the motion picture industry; both rating systems should be used, for complete coverage. The ratings are based on the ages of children. The number of hours blocked are specified. (See following pages.)

To insure complete coverage for all TV programs, (movies and regular TV shows) choose a rating for MPAA to restrict movies from the selections on the following pages. AND choose ratings from the TV Parental Guidelines Rating System also on the following pages, using the Age Block option for General Audiences and for Children. In addition to those, you may wish to add additional restrictions from the Content Block sub menu. See the Parental Control menu and submenus examples on the following pages.

Things to Consider before Setting Up Parental Control

- Determine which rating you consider acceptable to the viewer. For example, if you choose TV-PG, all more restrictive ratings will be automatically blocked; the viewer will not be able to see: TV-PG, TV-14 or TV-MA rated programming.
- Do you want to block the auxiliary video source entirely? (Blocks the signal sent by the equipment, such as a VCR, connected to the TV Audio/Video input jacks; in the Aux. Sources option.) Or leave unblocked, then choose allowable ratings.
- Block program "Content" based on individual parameters such as: Strong Dialog, Bad Language, Sex Scenes, Violence Scenes or Fantasy Violence Scenes; in the Content Blk option.
- How many hours do you want Parental Control to be active? You can set the Hours option for up to 99 hours (default is 12 hours).
- Select a password; in the Set Password option. Use the numbered keys on the remote to set a password. Don't forget the password.

Installer Menu Options For V-Chip Operation

V-Chip functionality can be disabled if the password is not known

Reset Parental Control Block Hours to Zero and Cancel Password

This provides the institution staff and the installer a means to reset the TV to normal operation; if a user has either forgotten the password or has left Parental Control blocks active. (Installer Menu item 0-I Installer Seq must be set to 0 for this to work.)

On the optional installer's remote control, press and hold down MENU until the menu disappears (takes about 8 seconds). Immediately press 9, 8, 7, 6 and then CC. This will reset the Block Hours to Zero and cancel the current 4-number password.

Make Parental Control Restrictions Permanent, With No Preset or Fixed Hours Time Limit

In the Installer's Menu, set

Item 84: PERMANENT BLK, 0 or 1.

0 Restrictions limited to specified hours, 12 - 99.

1 Blocking restrictions always active, no time limit.

Reset the Maximum Number of Parental Control Default Block Hours

You can change the Block hours from the 12-hour default setting to up to 99 hours.

In the Installer's Menu, item: 22-I MAX BLK HRS 12, use the ADJ Left/Right arrow to set a different default number of hours.

Turn Parental Control Feature Off or On

In the Installer's Menu, installer items:

21-I V-CHIP, 0 = disable, or 1 = enable

51-I DIS. VCHIP M., 0 = enable, or 1 = disable

Options Setups for V-Chip Menu and Block Functions

For Installer items:

21-I V-CHIP	51-I DIS VCHIP M	
0	0	No Menu, No Blocking.
0	1	No Menu, No Blocking.
1	0	Shows Menu, Block functions.
1	1	No Menu, Block functions.

Parental Control Menu

After you have read the preceding page, follow instructions below to set up and activate Parental Control

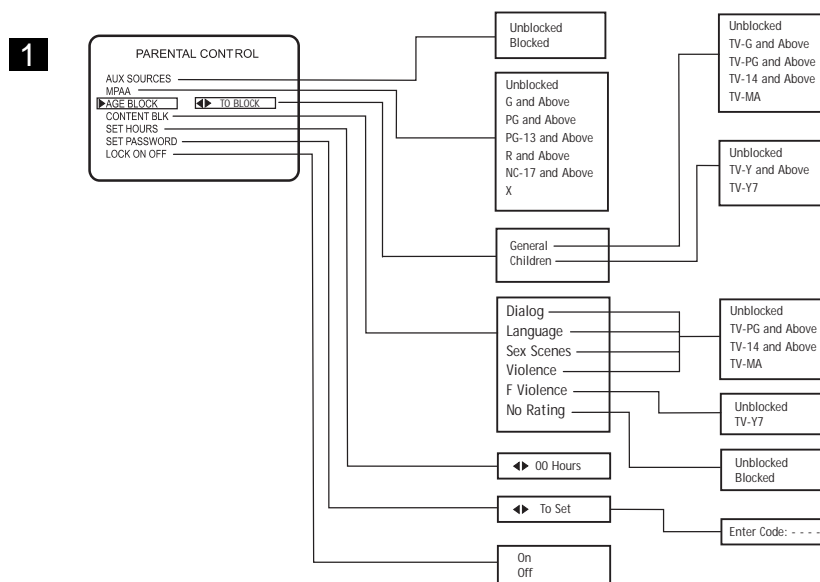

2 With the Parental Control menu on-screen, use Up or Down ADJ to highlight an option like Age Block for TV programs and movies, then press the Right ADJ arrow.

3 Use the Up/Down/Left/Right ADJ arrows to select and adjust or set the rating for an option. For Sex Scenes for example, use the "From TV-PG" setting. (See the Parental Ratings Charts on the next page for TV/Movie rating definitions).

4 After you have selected and adjusted the parental control menu options to your requirements:

- Set the hours you want Parental Control active.
- Set a 4-number password.
- Set the Lock On/Off option to On or Off.



No Rating means that the broadcast does not include rating information. You can choose to block broadcasts without V-Chip rating data.

Parental Control TV/Movie Rating Guidelines

TV Parental Guidelines Rating System

TV-G	General Audience	Considered suitable for all audiences; children may watch unattended.
TV-PG	Parental Guidance Suggested	Unsuitable for younger children, may contain: Suggestive Dialog, Foul Language, Sex and Violence Scenes.
TV-14	Parents Strongly Cautioned	Unsuitable for children under 14, may contain: Strong Dialog, Foul Language, Sex and Violence Scenes.
TV-MA	Mature Audiences Only	Adults only, may contain: Strong Dialog, Foul Language, Sex and Violence Scenes.

CHILDREN'S CLASSIFICATIONS

TV-Y	Children	Considered suitable for all children under 7 years old.
TV-Y7	Children 7 and over	Considered suitable for children over 7, may contain Fantasy Violence Scenes.

Motion Picture Association Of America (MPAA) Rating System

G	General Audiences	Content not offensive to most viewers.
PG	Parental Guidance Suggested	Content is such that parents may not want their children to view the program.
PG-13	Parental Guidance Suggested	Program is inappropriate for preteens, with a greater degree of offensive material than a PG rated program.
R	Restricted viewing	Not for children under age 17. Strong elements of sex and/or violence.
NC-17	Restricted Viewing	Not for children under age 17 under any circumstances. Strong sexual content.
X	Hard Core Films	Same as NC-17 rating.

Note: LG Electronics Corporation is not liable for any program content that appears when using this rating system; as always, user discretion is advised.



You can set different Parental Control viewing restrictions for general audiences and for children - - both can be active at the same time.



Simply specifying one TV program content block such as Sex Scenes, will not automatically block another undesirable content in the TV program from appearing.



Even if you choose to leave the Aux Source unblocked, the ratings you specify will automatically restrict the programming from the Aux audio/video source.



You cannot disable Parental Control by disconnecting the TV from power. Block hours will automatically reset to blocking time remaining if power is disconnected.

Channel Banks Setup

Use the Channel Banks to customize the channel offerings to the end user. The TV has four channel banks, where the administrator or installer can store groups of TV channels. Note: Channel banks set up requires an installer's remote with "Source" or "Bank" keys.

Planning The Channel Banks

Generally, TV channels are grouped into "program packages" with terms that are proposed to the end user. The user then opts for a package. Below is an example of how TV channels may be grouped.

Bank	Program Package
1	Basic cable channels
2	Extended cable channels
3	Extended with premium channels
4	Other cable service options

(Grouping is provided as an example only.)

You may plan your package by using a chart like the one after the following page. Remember, you can "blank" a channel for accommodating audio-only, such as an in-house communication channel. Sometimes, only one or two channel banks may be needed. You may leave any unused bank with the channels entered during Auto Program; or, you may delete the channels. However, you may want to leave at least one channel in any unused bank. Then, if someone selects an "unused" bank, that channel will assure them that the TV is functional. Note: Some channels from factory testing may be in the channel banks if you have not yet run Auto Program.

Adding/Deleting Channels

A previously prepared programming chart is helpful. (See next page.)

1. Run Auto Program (in the Setup menu). All channels found on your cable/antenna will be entered in Channel Bank 1, 2, 3, and 4.
Note: Be advised that running Auto Program overwrites any custom channel setups e.g. removes Blanked, Deleted.
2. Select a channel bank with the installer remote



The **BLNK** (blank) channel function is "global"
-- the same channel number is blanked in channel banks 1, 2, 3 and 4.

- press SOURCE/BANK (and repeat). CHANNEL BANK and BANK number are displayed.
3. Use the ADD/DEL/BLNK option (also in the



Channel Bank Number Display

Setup menu) to customize your program package. You may delete channels or add some that have not been entered. You can also 'Blank' a channel for accommodating an audio-only program source or in-house communication. See the "ADD/DEL/BLNK" menu page for more details.

Note: The Blank Channel feature is global. A channel will be blanked in all channel banks.

4. Repeat steps 2, and 3 to program another channel bank.

Inactive TV Display (Channel Bank 4)

The TV can be set up to be inactive; which would require an attendant using an installer remote to change to a "billable" active channel bank selection: Bank 1, 2 or 3.

Note: For institution control of patient-accessible programming, channels in Bank 4 need to be removed.



Inactive TV Display

Channel Banks Setup

Use the Channel Banks to customize the channels available to the end user
 Each channel bank is capable of storing up to 140 broadcast digital
 plus 125 analog channels

Figure 1. Typical channel banks after running Auto Program

BANK	Purpose	Channel Number																								
		1	2	3	4	5	6	7	8	9	10	11	12	13	14	15	16	17	18	19	20	21	22	23	24	25
1			A			A		A		A					A	A	A	A	A	A	A		A	A	A	A
2			A			A		A		A					A	A	A	A	A	A	A		A	A	A	A
3			A			A		A		A					A	A	A	A	A	A	A		A	A	A	A
4			A			A		A		A					A	A	A	A	A	A	A		A	A	A	A

A = Active -- Channel was found during AUTO PROGRAM

Figure 2. Typical channel banks after running Auto Program, and customizing with Add/Del/Blk

BANK	Purpose	Channel Number																								
		1	2	3	4	5	6	7	8	9	10	11	12	13	14	15	16	17	18	19	20	21	22	23	24	25
1	Basic		BC	A			A		A		A				D	D	D	D	D	D	D		D	D	D	D
2	Extend		BC	A			A		A		A				A	D	A	D	A	A	A		D	D	D	D
3	All CTV		BC	A			A		A		A				A	D	A	D	A	A	A		A	D	A	A
4	Other		BC	A			A		A		A				A	A	A	A	A	A	A		A	A	A	A

A = Active Channel was found during AUTO PROGRAM
 D = Delete Channel was deleted using Add/Del option.
 BC = Blanked Channel Channel was blanked using BLANK channel option (ADD/DEL/BLNK).

Adding / Deleting Channels

It is best to do ADD / DEL customizing before doing "BLNK." Auto Program (the channel search) enters the same channel numbers in Banks 1, 2, 3 and 4. Auto Program removes any channels previously customized with ADD / DEL / BLNK. The channels found in the channel search on your antenna / cable will be included, and any channels previously found but not currently available will not be included. ADD and DEL (not BLNK) can be used independently for channel banks 1, 2, 3 and 4. (If a channel is not found in the channel search, it cannot be added.)

Notes: A channel blanked, is blanked in all channel banks. Channels can be 'added' only if those channels were originally found in the channel search.

Channel allocations in tuning bands:

- Broadcast and Broadcast Digital: 2 - 69
- CABLE - CATV, HRC or ICC: 1 - 125

Channel Banks Setup

Use the Channel Banks form below to plan your program packages

Date _____ Installer _____

PLAN YOUR CHANNEL BANKS BY FILLING IN THESE CHARTS (or use photocopies)

B A N K	Purpose	Channel Number																								
		1	2	3	4	5	6	7	8	9	10	11	12	13	14	15	16	17	18	19	20	21	22	23	24	25
1																										
2																										
3																										
4																										

B A N K	Purpose	Channel Number																								
		26	27	28	29	30	31	32	33	34	35	36	37	38	39	40	41	42	43	44	45	46	47	48	49	50
1																										
2																										
3																										
4																										

B A N K	Purpose	Channel Number																								
		51	52	53	54	55	56	57	58	59	60	61	62	63	64	65	66	67	68	69	70	71	72	73	74	75
1																										
2																										
3																										
4																										

B A N K	Purpose	Channel Number																								
		76	77	78	79	80	81	82	83	84	85	86	87	88	89	90	91	92	93	94	95	96	97	98	99	100
1																										
2																										
3																										
4																										

B A N K	Purpose	Channel Number																								
		101	102	103	104	105	106	107	108	109	110	111	112	113	114	115	116	117	118	119	120	121	122	123	124	125
1																										
2																										
3																										
4																										

Installer Menu

Use the Installer Menu to set up or change operational settings.
See detailed descriptions of the Installer Menu items on the following pages

Installer menu items can be accessed by using the optional installer's remote control. Just press and hold MENU (about 8 seconds) until the menu disappears, then press 9, 8, 7, 6, then OK (Enter). To remove the Installer's Menu, press OK repeatedly. Any changes you make will be stored in non-volatile memory.

The Installer menu opens with the main menu. Use MENU and Up or Down ADJ to sequence through the installer menus and submenus. Use Up or Down ADJ to scroll up/down within the

menus and submenus. To change a setting, use the Left or Right ADJ keys. Press OK to return to the main menu.

Using the Installer Menu

Items 0-I ~ 117-I are accessible only in the Installer Menu. Their numbers, descriptions, ranges, factory default settings, and a place for listing any changes made on site are given below and on the following pages.

The Factory Menu that is intended for qualified service technicians only, is not shown. XX-F Menu Items (not shown here)

are service type adjustments and only qualified technicians having specialized test equipment should access them.

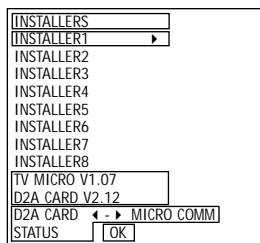

Menu Item	Function	Value Range	Default Value	Brief Description of Function and Comments
0-I.	INSTALLER SEQ	0 - 3	0	Leave default set at 0.
1-I.	POWER MANAGE	0 - 7	0	Sets number of hours of no activity before auto shutdown.
2-I.	AC ON	0 / 1	0	Set to 1 to enable auto turn on at power up.
3-I.	BAND-AFC	0 - 7	0	Sets Tuning band for Analog channels.
4-I.	STRT CHANNEL	0 - 255	255	Channel at turn-on (255 for last Channel). For digital channels, use with item 104-I Start Minor Channel.
5-I.	CHAN LOCK	0 / 1	0	When set to 1, cannot tune from current channel.
6-I.	GHOST CH	0 / 1	0	Set to 1 to enable Ghost Channel display.
7-I.	START VOLUME	0-63, 255	255	Volume level at TV turn-on (Set 255 to retain last level).
8-I.	MIN VOLUME	0 - 63	0	Minimum volume setting.
9-I.	MAX VOLUME	0 - 63	63	Maximum volume setting.
10-I.	MUTE DISABLE	0 / 1	0	Set to 1 to disable mute function.
11-I.	NOT USED			
12-I.	IR BANKS EN	0 / 1	0	Set to 1: enables TV to respond to IR codes to change Channel Bank directly.
13-I.	SCAN MODE	0 / 1	1	Puts TV On-Off event in Channel Up/Down sequence.
14-I.	STRT CH IN SM	0 / 1	0	Set to 1 to put TV On/Off below start channel number.
15-I.	SLEEP TIMER	0 / 1	1	Set to 1 to enable Sleep Timer.
16-I.	EN TIMER	0 / 1	1	Set to 1 to enable Timer.
17-I.	ALARM	0 / 1	1	Set to 1 to enable Alarm.
18-I.	NOT USED			
19-I.	NOT USED			
20-I.	FEATURE LEVEL	0 / 1	1	Zen 1 Leave default set 1 (1 Zen1).
21-I.	V-CHIP	0 / 1	1	Set to 1 to enable V-Chip (Parental Control).
22-I.	MAX BLK HRS	0 - 99	12	Sets number of Parental Control blocking hours.
23-I.	CAPTION LOCK	0 / 1	0	Set to 1 to retain caption setting at turn off.

Installer Menu

Installer Menu Items 24-I through 61-I

Menu Item	Function	Value Range	Default Value	Brief Description of Function and Comments
24-I.	TEXT MODE	0 / 1	1	Set to 1 to add Text option to closed caption menu.
25-I.	NOT USED			
26-I.	NOT USED			
27-I.	HOSPITAL MODE	0 - 2	2	Leave default set to 2.
28-I.	CH OVER RIDE	0 / 1	1	When set to 0, limits direct access to only channels in memory and locks out Auto Program function.
29-I.	OLD OCV	0 / 1	0	OCV should set to 1.
30-I.	ACK MASK	0 / 1	0	M.P.I. communication parameter.
31-I.	POLL RATE	20 - 169	94	M.P.I. communication parameter.
32-I.	TIMING PULSE	186 - 227	204	M.P.I. communication parameter.
33-I.	NOT USED			
34-I.	NOT USED			
35-I.	NOT USED			
36-I.	NOT USED			
37-I.	NOT USED			
38-I.	NOT USED			
39-I.	REAR VIDEO EN	0 / 1	1	Set to 1 to enable rear AUX video input.
40-I.	NOT USED			
41-I.	NOT USED			
42-I.	NOT USED			
43-I.	NOT USED			
44-I.	NOT USED			
45-I.	NOT USED			
46-I.	NOT USED			
47-I.	AUX STATUS	0 / 1	0	Set to 1 for M.P.I. AUX source reported as Channel number instead of Channel 0.
48-I.	DIS SETUP M	0 / 1	0	Set to 1 to disable Setup menu.
49-I.	NOT USED			
50-I.	DIS VIDEO M	0 / 1	0	Set to 1 to disable Video menu.
51-I.	DIS VCHIP M	0 / 1	0	Set to 1 to disable V-Chip (Parental Control) menu.
52-I.	NOT USED			
53-I.	DIS CHTIME	0 / 1	0	Set to 1 to disable Channel-Time on-screen display.
54-I.	EN SET COL	0 / 1	0	Set to 1 to enable custom color for the Setup menu.
55-I.	FOR SETUP M	0 - 7	6	Custom foreground color for the Setup menu.
56-I.	BCK SETUP M	0 - 7	4	Custom background color for the Setup menu.
57-I.	NOT USED			
58-I.	NOT USED			
59-I.	NOT USED			
60-I.	EN VIDEO COL	0 / 1	0	Set to 1 to enable custom color for the Video menu.
61-I.	FOR VIDEO M	0 - 7	4	Custom foreground color for the Video menu.

Installer Menu

Installer Menu Items 62-1 through 88-1

Menu Item	Function	Value Range	Default Value	Brief Description of Function and Comments
62-1.	BCK VIDEO M	0 - 7	7	Custom background color for the Video menu.
63-1.	EN PTL COL	0 / 1	0	Set to 1 to enable custom color for the V-Chip (Parental Control) menu.
64-1.	FOR PTL M	0 - 7	6	Custom foreground color for the V-Chip (Parental Control) menu.
65-1.	BCK PTL M	0 - 7	4	Custom background color for the V-Chip (Parental Control) menu.
66-1.	NOT USED			
67-1.	NOT USED			
68-1.	NOT USED			
69-1.	EN CHT COL	0 / 1	1	Set to 1 to enable custom color for the Channel-Time on-screen display.
70-1.	FOR CHT COL	0 - 7	1	Custom foreground color for the Channel-Time OSD.
71-1.	BCK CHT COL	0 - 7	1	Custom background color for the Channel-Time OSD.
72-1.	NOT USED			
73-1.	CH NOT AVBLE	0 / 1	0	If set to 1 and channel over ride is set to 0, "NOT AVAILABLE" message is displayed when directly accessing a channel not in the favorite channel list.
74-1.	CHTIME SIZE	0 / 1	0	If set to 1 and transparent background is selected for Channel-Time display, (foreground color = background color and custom color enabled) a large channel number is displayed instead of the normal Channel-Time on-screen display.
75-1.	REVERT CH	0 / 1	0	If set to 1 and loss of M.P.I. communication occurs, TV tunes to Start Channel.
76-1.	DEFEAT XDS	0 / 1	0	If set to 1, XDS display program information will not appear.
77-1.	QUICK SHUTOFF	0 - 17	0	Allows TV turn off with pillow speaker Channel button.
78-1.	UPN MSB	0 - 255	XX	User programmable number, most significant byte. (Line - Day)
79-1.	UPN MSB1	0 - 255	XX	User programmable number, most significant byte- 1. (Week)
80-1.	UPN MSB2	0 - 255	XX	User programmable number, most significant byte- 2. (SN - HIGH)
81-1.	UPN LSB	0 - 255	XX	User programmable number, least significant byte. (SN - LOW)
82-1.	CHKSM ERROR	0 / 1	1	Enforces rigid M.P.I. checksum.
83-1.	HANDSHK TIME	0 - 5	0	Relaxes M.P.I. timing to be compatible with PC based Windows controlled systems.
84-1.	PERMANENT BLK	0 / 1	0	Set to 1 to remove block hours setting for Parental Control and make blocks permanent.
85-1.	NOT USED			
86-1.	NOT USED			
87-1.	NOT USED			
88-1.	EN NOISE MUTE	0 / 1	1	If set to 1, the audio signal volume is limited to a minimum value if no signal is being received from the broadcaster.

Installer Menu

Installer Menu Items 89-I through 117-I

Menu Item	Function	Value Range	Default Value	Brief Description of Function and Comments
89-I.	POKE ENABLE	0 / 1	0	If set to 1, writing to Non - volatile memory through *M.P.I. is enabled.
90-I.	KEY LOCK	0 / 1	0	If set to 1, front keyboard functionality is disabled.
91-I.	NOT USED			
92-I.	NOT USED			
93-I.	NOT USED			
94-I.	NOT USED			
95-I.	NOT USED			
96-I.	NOT USED			
97-I.	NOT USED			
98-I.	NOT USED			
99-I.	NOT USED			
100-I.	NOT USED			
101-I.	NOT USED			
102-I.	NOT USED			
103-I.	NOT USED			
104-I	STRT MINOR CH	0 - 255	0	Selects Minor start channel. Set 0 for NTSC. Not 0, sets Minor channel number.
105-I	NOT USED			
106-I	A RATIO LOCK	0 / 1	0	To retain set aspect ratio on power cycle, set to 1. Set to 0 for default ratio on power cycle.
107-I	NOT USED			
108-I	NOT USED			
109-I	NOT USED			
110-I	NOT USED			
111-I	NOT USED			
112-I	NOT USED			
113-I	NOT USED			
114-I	NOT USED			
115-I	NOT USED			
116-I	NOT USED			
117-I	RESET2DEFAULT	0 / 1	0	0=Normal. 1=Loads factory default presets for all Installer menu settings.

Detailed Descriptions of Installer Menu Items

0-I. INSTALLER SEQUENCE

Gives access to Installer Menu depending on the code selected.

0 = 9876 1 = 4321 2 = 1478 3 = 3698

1-I. POWER MANAGE (Power Management)

Determines hours of no activity before automatic shutoff. The POWER MANAGE function is for saving energy. If set to 0, Power Manage is OFF. Settings

range from 0 - 7, with 1 - 7 representing the hours that the TV will remain on, unless there has been activity from either the control panel or remote control.

*M.P.I. Multiple Protocol Input: Zenith protocol for remote control of TV through RJ11 (M.P.I.) jack on TV connections panel.

Installer Menu

Detailed Descriptions for Installer Menu Items 2-1 through 9-1

2-1. AC ON (AC Power Switchable)

Allows the TV to turn ON just by applying AC power. Pressing the POWER button is not necessary. This is desirable if the TV is plugged into a cable box or a power outlet controlled by a wall switch. Use Left or Right ADJ to select 0 or 1, where 0 is the default is OFF, and 1 is ON.

Note: If set to 1 (ON), the TV does not respond to ON/OFF commands from either the remote or the front control panel, and the SLEEP TIMER is also not functional.

3-1. BAND/AFC (Band/Automatic Frequency Control) for Analog Channels

There are 8 possible settings for this option:

0 = Broadcast Fixed	4 = Broadcast AFC
5 = CATV Fixed	1 = CATV AFC
6 = HRC Fixed	2 = HRC AFC
7 = IRC Fixed	3 = IRC AFC

Channels are accessed faster when fixed modes are used. The AFC (search modes) should only be used when some channels are not on nominal frequencies. **Note:** Set BAND/AFC in Installer menu before running AUTO PROGRAM. If some channels are not found by Auto Program, rerun Auto Program when channel is broadcasting a program.

4-1. STRT CHANNEL (Start Channel)

 Important: For NTSC start channel, item 104-1 STRT MINOR CHANNEL, must be set to 0. If active, this function allows you to determine the initial channel number when the TV is turned ON. (To set a digital channel, use with Item 104 Start Minor Channel.) This feature is useful for an in-house information channel, since the TV would always select that channel when it is turned ON. Setting this to 255 causes the last channel viewed when TV was turned OFF to be the tuned to channel when the TV is turned ON again. The range of values is 0 - 255. Use ADJ (adjust) keys to choose numbers for the start channel.

5-1. CHAN LOCK (Channel Lock)

CHAN LOCK is ideal if a cable box (or similar) is the sole source for programming—and the TV must always be on the same channel. Changing channels with Channel Up/Down or keypad numbers is impossible. Channel Lock is inactive if set to 0

(default). Generally, this feature is used in conjunction with START CHANNEL (item 4-1.) where the start channel may, for example, be set to 3 or 4. If the start channel is 3, then the TV will remain on channel 3. **Note:** If CHANNEL LOCK is active and CHANNEL OVER RIDE is disabled, AUTO PROGRAM is not functional.

6-1. GHOST CH (Ghost Channel)

If set to 1, the current channel number is displayed in the upper right corner of the picture. The number moves slightly to prevent damage to the screen. The default is "0" or OFF. **NOTE:** When captions are on, "Ghost Channel!" is not displayed.

7-1. START VOLUME

This function allows the Installer to determine the initial volume level setting when the TV is turned ON. This feature is useful for an in-house information channel, since the TV would always select that Volume level when it is turned on. The range of values are 0 - 63, 255. If 255 is selected, the current volume level will be retained in memory when the TV is turned Off. At TV turn On, Volume level is automatically set to the previous level.

8-1. MIN VOLUME (Minimum Volume)

This function determines the minimum volume level allowable with the VOLUME (VOL) Up/Down control. In this way, for example, someone cannot set the sound too low to hear. The range is from 0 to 63 change values with ADJ (Adjust) Left/Right keys. The factory default is 0, which provides full range of volume control. It may be best to set the same value on every TV.

Note: The minimum volume level cannot have a value setting higher than in the MAX VOLUME level (described below).

9-1. MAX VOLUME (Maximum Volume)

This function determines the maximum volume level allowable with the VOLUME Up/Down control. In this way, for example, someone cannot set the sound level high enough to disturb others. The range is 0 to 63, with 63 as the default which gives the user the full range of volume control.

Continued on next page.

Installer Menu

Detailed Descriptions for Installer Menu Items 10-1 through 25-1

Change values with ADJ (Adjust) Left/Right keys. It may be best to set the same value on every TV.
Note: The maximum volume level cannot have a value setting lower than the MIN VOLUME level (See Item 8 -1).

10-1. MUTE DISABLE

Enables or disables sound mute function. If set to 1, sound cannot be muted. If set to 0, sound can be muted.

11-1. NOT USED

12-1. IR BANKS EN (IR Banks Enable)

For direct access to a particular Channel Bank. When enabled, installer can access a channel bank by inputting the IR code for the bank.

13-1. SCAN MODE

Allows variation in the On/Off setup with CHANNEL Up/Down. You may opt for TV channels only or TV channels + Off/On with the following settings for Scan Mode. Scan mode Characteristics:

0 = Channel Up/Down keys Change channels only.
1 = Channel Down below the lowest channel (or channel up higher than the highest channel) and the TV turns Off.

Note: If the start channel is digital, TV turns off as above. From TV Off state, TV does not tune in at lowest analog / Rear Aux when Channel Up/Down is pressed.

14-1. STRT CH IN SM (Start Channel in Scan Mode) If set to 1, installs TV On/Off event below the start channel at TV turn On.

15-1. SLEEP TIMER

If set to 1, the Sleep Timer feature is available (but no message is displayed prior to turn-Off). If set to 0, the Sleep Timer is not functional.

16-1. EN. TIMER (Enable Timer)

If set to 1, On/Off Timer functions are available to end user. Set to 0 to disable Timer functions.

Note: Clock must be set in order to use Timers.

17-1. ALARM

Gives you the option of making the Alarm function available to the user. Set to 1, Alarm function is available to user. Set to 0 to disable the Alarm function. **Note:** Clock must be set in order to set the Alarm.

18-1. NOT USED

19-1. NOT USED

20-1. FEATURE LEVEL

Default set to ZEN 1 for Zenith IR remote control operation. Set 0, P LBL for Zenith Private Label IR remote control operation.



WARNING: Do not change the default value unless you have the proper remote control to operate the TV.

21-1. V-CHIP

Set to 1 to activate V-Chip (Parental Control); have it available to user to filter or control or restrict programming content. Set to 0 to turn V-Chip feature Off, not available to user; no programming restrictions can be set.

22-1. MAX BLK HRS (Maximum Block Hours)

Set 0 to 99 for the maximum V-Chip (Parental Control) block hours. Default setup is for 12 blocking hours.

23-1. CAPTION LOCK

Set to 1 (On) to restore previous Caption On/Off state after TV turns Off. If set to 0 (Off), Captions are always Off, when TV is initially turned On.

24-1. TEXT MODE

Determines whether TEXT 1, TEXT 2, TEXT 3, or TEXT 4 decoding is enabled when TEXT is turned on (either from the Setup Menu or directly with CC on the remote).

TIP: Set Text Mode to 1 only if text is offered in your video system.

25-1. NOT USED

Installer Menu

Detailed Descriptions for Installer Menu Items 26-I through 53-I

26-I. NOT USED

27-I. HOSPITAL MODE

The default is 2 (which favors most hospitals). With this setting two things are affected: Channel Banks 1, 2 and 3 are accessible, while Bank 4 can be made inactive by removing all the channels from Channel Bank 4. Then, if Channel Bank 4 is selected when the TV is turned on, the TV screen will show "Inactive TV". The Channel Bank 4 setup allows the hospital to present TV viewing options to the patient. The patient can select programming options available in either Bank 1, 2 or 3. Channel Banks are available in all hospital modes.

- The IR code that will control the TV depends on Item 20-I Feature Level setting.

Hosp. Mode = 0 Not hospital mode.

Hosp. Mode = 1 Zenith P.L. IR Code (Bed 1)

Hosp. Mode = 2 Zenith IR Code (Bed 2)

28-I. CH. OVER RIDE (Channel Override)

If set to 1, the user can select channels with either Channel Up/Down or by direct keypad entry. If set to 0, only those channels that are entered

for scanning may be selected by direct keypad entry. **Note: If set to 0, Auto Program is locked out; (as shown on Setup menu) channel search is not available.**

29-I. OLD OCV (On Command Video™)

Set to 1 for operation with systems from On Command Corporation.

30-I. ACK MASK

M.P.I. Communication Parameter. Leave at default setting unless changed by Pay-Per-View provider.

31-I. POLL RATE

M.P.I. Communication Parameter. Leave at default setting unless changed by Pay-Per-View provider.

32-I. TIMING PULSE

M.P.I. Communication Parameter. Leave at default setting unless changed by Pay-Per-View provider.

33-I. NOT USED

34-I. NOT USED

35-I. NOT USED

36-I. NOT USED

37-I. NOT USED

38-I. NOT USED

39-I. REAR VIDEO EN. (Rear Video Enable)

Set to 1 to enable rear AUX (Video) input.

Set to 0 to disable rear AUX input.

40-I. NOT USED

41-I. NOT USED

42-I. NOT USED

43-I. NOT USED

44-I. NOT USED

45-I. NOT USED

46-I. NOT USED

47-I. AUX STATUS

Set to 1 for M.P.I. AUX source to be reported as a channel number instead of channel 0. Set to 0 to disable AUX identification change.

48-I. DIS SETUP M (Disable Setup Menu)

Set to 1 to disable the Setup menu. Setup menu will not appear. Set to 0 to enable the Setup menu.

49-I. NOT USED

50-I. DIS VIDEO M (Disable Video Menu)

Set to 1 to disable the Video menu. Video menu will not appear. Set to 0 to enable the Video menu.

51-I. DIS VCHIP M (Disable V-Chip Menu)

Set to 1 to disable V-Chip menu. V-Chip menu will not appear. Set to 0 to enable the V-Chip menu.

52-I. NOT USED

53-I. DIS CH-TIME (Disable Channel-Time OSD)

Set to 1 to disable the Channel-Time display.

Channel-Time display will not appear.

Set to 0 to enable the Channel-Time display.

Installer Menu

Detailed Descriptions for Installer Menu Items 54-I through 70-I

Notes: For Items 55-I to 71-I. Foreground Color 0 (Black), will only show highlighted option in black on menu, regardless of the background color chosen. Other Setup menu options will be blue. If Foreground and Background numbers are 0, background color will be transparent and all menu text will be Blue.

54-I. EN SET COL (Enable Setup Menu Color)

Set to 1 to enable custom color settings for the Setup menu. Set to 0 to disable custom color settings for the Setup menu.

55-I. FOR SETUP M (Setup Menu Foreground Color) Set according to Color Chart.

0 = Black 3 = Yellow 6 = Cyan
1 = Red 4 = Blue 7 = White
2 = Green 5 = Violet

56-I. BCK SETUP M (Setup Menu Background Color) Set according to Color Chart.

0 = Black 3 = Yellow 6 = Cyan
1 = Red 4 = Blue 7 = White
2 = Green 5 = Violet

Note: If foreground and background color are the same, menu background is transparent.

57-I. NOT USED

58-I. NOT USED

59-I. NOT USED

60-I. EN VIDEO COL (Enable Video Menu Color)

Set to 1 to enable custom color settings for the Video menu. Set to 0 to disable custom color settings for the Video menu.

61-I. FOR VIDEO M (Video Menu Foreground Color)

0 = Black 3 = Yellow 6 = Cyan
1 = Red 4 = Blue 7 = White
2 = Green 5 = Violet

62-I. BCK VIDEO COL (Video Menu Background Color)

0 = Black 3 = Yellow 6 = Cyan

1 = Red 4 = Blue 7 = White
2 = Green 5 = Violet

63-I. EN PTL COL (Enable V-Chip Menu)

Set to 1 to enable custom color settings for the V-Chip menu. Set to 0 to disable custom color settings for the V-Chip menu.

64-I. FOR PTL M (V-Chip Menu Foreground Color) Set according to Color Chart.

0 = Black 3 = Yellow 6 = Cyan
1 = Red 4 = Blue 7 = White
2 = Green 5 = Violet

65-I. BCK PTL M (V-Chip Menu Background Color) Set according to Color Chart.

0 = Black 3 = Yellow 6 = Cyan
1 = Red 4 = Blue 7 = White
2 = Green 5 = Violet

66-I. NOT USED

67-I. NOT USED

68-I. NOT USED

69-I. EN CH-T COL (Enable CH-Time OSD Color)

Set to 1 to enable custom color for the Channel-Time display. Set to 0 to disable custom color for the Channel-Time display.

70-I. FOR CH-T COL (Channel-Time Display Foreground Color)

0 = Black 3 = Yellow 6 = Cyan
1 = Red 4 = Blue 7 = White
2 = Green 5 = Violet

Note: If foreground and background color are the same, menu background is transparent.

Installer Menu

Detailed Descriptions for Installer Menu Items 71-I through 90-I

71-I. BCK CH-T COL (Channel-Time Display Background Color) See Notes on page 48.

0 = Black 3 = Yellow 6 = Cyan

1 = Red 4 = Blue 7 = White

2 = Green 5 = Violet

Note: If foreground and background color are the same, menu background is transparent.

72-I. NOT USED

73-I. CH NOT AVBLE (Channel Not Available)

When set to 1 and channel override is set to 0, "NOT AVAILABLE" message is displayed when directly accessing a channel not in the favorite channel list. **(Applies to NTSC Channels Only.)**

74-I. CH-TIME SIZE

If set to 1 and transparent background is selected for Channel-Time display, (foreground color = background color and custom color enabled) a large channel number is displayed instead of the normal Channel-Time display.

75-I. REVERT CH (Revert Channel)

If set to 1 and loss of M.P.I. communication occurs, TV automatically tunes to the specified Start Channel.

76-I. DEFEAT XDS

Set to 1 to disable XDS display. Set to 0 to enable XDS display. XDS data (provided at the discretion of the broadcaster), is available only on analog channels. After a channel change, wait 5 seconds then press ENTER to see XDS data, if available.

77-I. QUICK SHUTOFF

Allows TV power Off event to be controlled by all Remote Control, TV front Panel and Pillow Speaker Channel Up/Down buttons. User would push and hold channel button down for time required to have TV turn Off. Setting 0 = disabled. Value Range 0 - 17, each number represents 1/2 second. For example, if set to 4, TV would turn Off if user held any channel button down for 2 seconds.

78-I. UPN MSB

User programmable number, most significant byte readable by M.P.I. command.

79-I. UPN MSB-1

User programmable number, most significant byte-1 readable by M.P.I. Command.

80-I. UPN MSB-2

User programmable number, most significant byte-2 readable by M.P.I. command.

81-I. UPN LSB

User programmable number, least significant byte readable by M.P.I. command.

82-I. CHKSM ERROR

Enforces rigid M.P.I. checksum validation.

Set to 1 for validation.

Set to 0 to turn off.

83-I. HANDSHK TIME

Adds an additional delay to the handshake time which is 64 msec, thus relaxing M.P.I. timing requirements to be compatible with PC based Windows controlled systems, range is 0 - 5.

Set to 0 to retain standard 64 msec delay.

Set to 1 - 5 to increase @ 16 msec ea., the delay up to 144 msec.

84-I. PERMANENT BLK

Allows Parental Control blocking schemes to be permanent by removing the blocking hours function.

Set to 1 to install Parental Control blocking restrictions permanently.

Set to 0 for user-specified hours control of blocking schemes.

85-I. NOT USED

86-I. NOT USED

87-I. NOT USED

88-I. EN NOISE MUTE

If set to 1, the audio signal volume is limited to a minimum value if no signal is being received from the broadcaster.

89-I. POKE ENABLE

If set to 1, writing to Non-volatile Memory thru M.P.I. is enabled.

90-I. KEY LOCK

If set to 1, front keyboard buttons Channel, Volume and Captions are disabled, Power button remains enabled. If set to 0, front keyboard Channel, Volume, Captions and Power buttons are all enabled.

Installer Menu

Detailed Descriptions for Installer Menu Items 91-I through 117-I

91-I. NOT USED

92-I. NOT USED

93-I. NOT USED

94-I. NOT USED

95-I. NOT USED

96-I. NOT USED

97-I. NOT USED

98-I. NOT USED

99-I. NOT USED

100-I. NOT USED

101-I. NOT USED

102-I. NOT USED.

103-I. NOT USED.

104-I. STRT MINOR CH (Start Minor Channel)

Sets the starting minor digital channel number. For NTSC set at 0. If not 0, sets digital minor start channel number. Used with item 4-I Start Channel. Set the major channel number in 4-I and the minor digital dash number in item 101-I. At TV turn On, start channel number is automatically tuned in. Set to 0 if item 4-I is set to 255 for last tuned channel.

105-I. NOT USED

106-I. A RATIO LOCK (Aspect Ratio Lock)

If set to 1, current picture aspect ratio is retained at power off. At power on, previous aspect ratio will be used. If set to 0, resets aspect ratio to default setting at TV turn on.

107-I. NOT USED

108-I. NOT USED

109-I. NOT USED

110-I. NOT USED

111-I. NOT USED

112-I. NOT USED

113-I. NOT USED

114-I. NOT USED

115-I. NOT USED

116-I. NOT USED

117-I. RESET2DEFAULT

If set to 1 and OK (Enter) is pressed, TV will reset Installer menu items to their default settings. Reset will remove both analog and digital channels and any custom channel labels or custom menu settings.

LT2000/LT2002 QuickSet Clone Programmer

Use the QuickSet II "Clone" Programmer to copy the setup from a "master" TV then quickly transfer the setup to duplicate TV's; must be the same model number as the master TV.

THE CLONE HAS CONTROL OF THE TV

THE CLONE IS VERSION XX
 THE TV IS VERSION XX
 THE SW IS REVISION XX

CLONE CLOCK = XX:XX
 TV CLOCK = XX:XX

-PRESS ANY KEY TO CONTINUE.

-DISCONNECT CLONE WHEN DONE.

Learn Master TV Setup
Typical MPI Connections

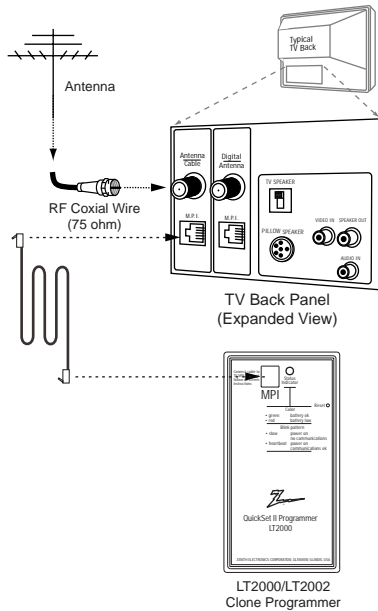

Teach Other TV the Setup
Typical MPI Connections

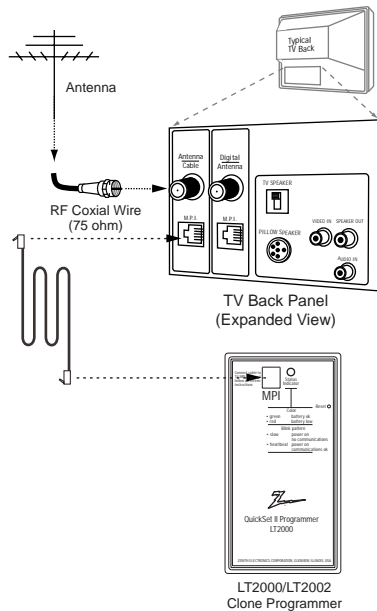

The optional QuickSet II Clone Programmer (LT2000/LT2002) allows custom setup and programming information to be quickly copied from a master TV into multiple identical television sets. Once learned from the master, setup data is retained in the clone programmer for future use.

When using the LT2002, cloning operations will work only if the TV is tuned to an **Analog** channel with a quality signal and operating with a stable picture displayed. To operate the LT2002, use the indicated keys on a HealthView Installer's remote or the remote shown on page 16.

Notes: Use only one MPI port for cloning. Do not run Auto Program while cloning.

LT2000/LT2002 QuickSet Programmer

Cloning Preparations

Before You Begin Cloning...

- Only use one MPI port for connecting to MPI equipment.
- Do not run Auto Program while TV is connected to clone programmer.
- The “master TV” should be connected to a good, stable signal from an over-the-air antenna or cable service and turned on.
- Teaching and Learning is only possible between identical model Zenith TV's. (However, the Clone programmer can store 3 different master TV setups.)

WARNING: Copying a blank or incorrect memory into a TV will cause the TV to operate erratically or become inoperable.



- Use a typical Zenith HealthView Installer remote or the Installer remote shown on page 16 to operate Learning and Teaching menus.
- Make sure that the batteries in the Clone programmer are fresh.
- If the batteries are removed, the Clone Clock time will be lost.
- Decide if you want to set the time from the Clone programmer or copy the time to the Clone programmer; from a TV which has the clock set to the current time.

- Follow the connection diagrams on the previous page to connect the Clone to a master TV and, after learning is complete, to another TV to “teach” it the setup.
- Setting the time and transferring it to the Clone or another TV is a separate procedure.
- Once a TV's setup is copied to another TV, the target TV needs to be disconnected from power for about 15 seconds to activate the newly-copied setup.
- See Troubleshooting to solve problems.

A. Set Up a Master TV

Using the installer remote shown on page 16, set up a “Master” TV with custom settings and features as described in the TV's operating guide.

The master TV's Setup is what you will copy to the Clone Programmer and transfer to TV's with the same model number so they will operate identically.

B. Connect Clone to Master TV

If there is a good connection, the “Clone has Control of the TV” message will appear on the TV screen. (See menu on the previous page.)



A slow flashing green light indicates there is a problem with the communications between the TV and the programmer. In this case, check for a damaged cable, poor contacts or other connection troubles.



If the status indicator is red, the programmer batteries are low and should be replaced. Use 4 good-quality alkaline AA batteries.

LT2000/LT2002 QuickSet Programmer

Cloning

```
THE CLONE HAS CONTROL OF THE TV

THE CLONE IS VERSION      XX
THE TV IS VERSION        XX
THE SW IS REVISION       XX

CLONE CLOCK   = XX:XX
TV    CLOCK   = XX:XX

-PRESS ANY KEY TO CONTINUE.

-DISCONNECT CLONE WHEN DONE.
```

```
CLONE SELECTION MENU

(1) LEARN FROM TV
(2) TEACH TO TV
(3) SET CLONE CLOCK FROM TV
(4) SET TV CLOCK FROM CLONE
(5) DISPLAY TV SETUP
(6) DISPLAY CLONE SETUP

-TO CHANGE MENU ITEMS, PRESS
CHANNEL KEYS OR DIGITS.
-TO EXECUTE ITEM, PRESS ON/OFF,
POWER, OR ENTER
```

C. Learn Setup from Master TV

Press 1 to select the "Learn From TV" option, then press ON/OFF, POWER, or ENTER to go to the Memory Bank Selection Menu. Pick the Memory "Bank" you want to store this Master TV's Setup in by pressing either Channel key repeatedly to pick Memory 1, 2 or 3. (If you choose a Memory "Bank" that already has a master TV's setup in it, it will be overwritten by this Master TV's setup.)

Once the Clone memory bank is selected, press ON/OFF, POWER or ENTER. The Clone memory bank you have selected will be shown. Press ON/OFF or POWER to begin copying the master TV's setup.

Ca. Set the Clock (Optional)

Set the time on the Master TV's Clock. (If the time has already been copied from another TV into the Clone programmer, you can set the Master TV's clock by copying the time from the Clone programmer.) The LT2000 Clone Programmer can copy the current time to both a master TV and to the Clone's internal clock; accurate to within one minute. (Another reason that the Clone programmer should be equipped with fresh, high-quality alkaline batteries is for it to keep the time as accurately as possible.)

Since the Clone Programmer's time cannot be set directly, the time needs to be copied from a Zenith TV equipped with M.P.I. Input capability.

Once the time is copied to the Clone programmer, the current time can then be transferred to another TV. (This can be a Master TV, or another TV which has had the features already set up.)

D. Teach Master TV's Setup to Another Identical TV

After Learning is complete, remove the M.P.I. cable from the master TV and connect it to the TV that you want to copy the master TV's setup to. With the "TV is Controlled by Clone" message displayed, press 2 or use either Channel key to go to the "Teach to TV" option, press ON/OFF, POWER or ENTER.

Follow on-screen instructions to transfer the Setup and other information to the "Learning" TV. After the "Teach to TV is Complete" message is displayed, press any key to return to the Clone menu option, then press ON/OFF, POWER or ENTER. If finished, remove the M.P.I. Cable from the TV.

E. Disconnect TV Power for 15

Seconds Unplug the TV power cord of the newly "Cloned TV" from the power outlet for about 15 seconds to activate the newly-copied Setup.

LT2000/LT2002 Clone Programmer

Clone Operation Notes

Disconnect the Clone from the TV when you are finished; automatically switching it off. The real-time clock continues to run after the main circuits are switched off.

Reset Clone After Static Shock

After replacing exhausted batteries, or if the programmer behaves strangely after a static shock, use a paper clip or similar instrument inserted through the small hole marked "RESET" to activate the internal reset switch and restore normal operation.

After a reset, check the real-time clock setting. It may be necessary to reset the Clone Programmer clock from a TV containing the correct time.

The LT2002 programmer is designed to be used with TV's containing the 221-01006 and later processors. Use with earlier TV sets may give unpredictable results. The specific microprocessor used in any TV set may be determined by activating the Installer Menu. The microprocessor part number appears on the screen when the Installer Menu is activated. Processors before the 221-01006-04 have a limited screen display capability. They can not display entire screens as shown in the quick setup instructions accompanying the LT2002 clone programmer. Use the printed menu illustrations on the quick setup sheet supplied with the Clone as an aid to making your programming choices. (Although the menus are not all displayed, the clone functions all operate normally).

Clone Programmer/Cloning Procedure Troubleshooting

Problem	Possible Cause(s)	Possible Solution(s)
Clone Programmer		
LED does not blink.	<ul style="list-style-type: none"> • M.P.I. cord not connected. • TV not turned On. • Weak batteries. 	<ul style="list-style-type: none"> -Connect M.P.I. cord. -TV must be On for clone to work. -Install 4 fresh AA high-quality alkaline batteries.
Clone menu hard to read.	<ul style="list-style-type: none"> • Weak signal. 	<ul style="list-style-type: none"> -Connect TV to a reliable signal Source.
No time set.	<ul style="list-style-type: none"> • No time on Master TV. 	<ul style="list-style-type: none"> -Set time on master TV, copy time to Clone Programmer.
Menu items 7-8 not on clone selection menu.	<ul style="list-style-type: none"> • Not necessary. 	<ul style="list-style-type: none"> -Channel Labels already cloned; if they were on Master TV.

Master and Other TV's

Cloning did not work.	<ul style="list-style-type: none"> • Procedure interrupted. • Different TV models. 	<ul style="list-style-type: none"> -Wait until procedure complete message is displayed. -Cloning is only possible with identical model Zenith TV's.
Clone time disappeared.	<ul style="list-style-type: none"> • Batteries were removed. 	<ul style="list-style-type: none"> -Batteries must remain installed to retain time settings.
New Setup not present.	<ul style="list-style-type: none"> • TV not reset. 	<ul style="list-style-type: none"> -Disconnect newly-cloned TV from power for 15 seconds.
Digital information not present.	<ul style="list-style-type: none"> • 2-5-5 + Menu not done. 	<ul style="list-style-type: none"> -Redo setup and 2-5-5 + Menu as required.



When cloning operations are complete, just unplug the LT2000 from the TV.



If the TV does not display a picture (blank screen) after a few seconds, just change channels.

Troubleshooting

Some Quick and Easy Tips for Resolving Problems

Installer Menu Settings and TV Problems

Installer menu item settings dictate how the TV functions. If a feature is not available or a problem can not be solved, check the installer menu settings to assure feature and functional items are set to appropriate levels, etc.

Symptom(s)	Possible Cause(s)	Possible Solution(s)	Page(s)
Power			
No Power.	<ul style="list-style-type: none">AC Power Cord not connected or power outlet doesn't work.	Connect power cord. Try a different power outlet. Local power failure?	17
Remote Control Problems			
Remote doesn't work.	<ul style="list-style-type: none">Wrong Bed setting.	Select Bed 2 on remote, unless Bed 1 is used.	16
	<ul style="list-style-type: none">TV software functioning.	Wait until software function is complete.	
	<ul style="list-style-type: none">Not aimed at remote sensor.	Point remote at TV Front Control Panel.	17
	<ul style="list-style-type: none">Remote too far from TV or IR path to TV obstructed.	Move remote closer to TV or darken room. Remove obstructions.	
	<ul style="list-style-type: none">Weak batteries.	Replace batteries.	17
	<ul style="list-style-type: none">Wrong battery polarity.	Check that "+" and "-" match in battery compartment.	17
	<ul style="list-style-type: none">Too much light in room.	Dim room light.	
Caption/Text Problems			
Picture has a big black box on it, but the sound is okay.	<ul style="list-style-type: none">Caption/Text mode turned On.	The CC (closed captions) option may be in Text 1, 2, 3, or 4 mode. Select Caption 1, or OFF in the Caption/Text menu.	26/27
No Closed Captions or Text.	<ul style="list-style-type: none">Not available on program.Not provided by broadcaster. (Even though CC indicated on OSD)Not turned On.	Check local TV listings to see if available on broadcast. Relocate over-the-air antenna. Try a different channel with Closed Captions or Text. Pick a Closed Caption or Text option and turn Captions On.	
Channel-Time Display for Analog/Digital Channels Problems			
Time on Analog-Digital OSDs is not the same.	<ul style="list-style-type: none">Automatic selected for Time Zone on Clock menu.	Select your local time zone in Time Zone menu to match clock time on analog and digital Ch-Time OSDs. Note: Analog and digital time OSDs may be a few minutes off. e.g. Analog = 4:10 p.m. Digital = 4:13 p.m.	25
Ch Preview Problems			
Ch preview menu does not appear when Ch Preview on remote is pressed.	<ul style="list-style-type: none">Digital channel tuned in.	Ch Preview only tunes in analog channels and Aux.	19

Troubleshooting

Some Quick and Easy Tips for Resolving Problems

Symptoms	Possible Cause(s)	Possible Solution(s)	Page(s)
Picture Reception			
Poor or no picture.	<ul style="list-style-type: none"> Channel Blanked. TV station problems. Video menu not adjusted properly. 	Set channel to 'Add' in Add/Del/Blk menu. Try a different channel. Check Video menu option settings.	21 16/17 32
Local interference.	<ul style="list-style-type: none"> Check for disturbing source. Appliance too close to TV. 	The following may cause image problems or distortion: Electrical appliances, powerful lights, cars, trucks; computers or portable phones; medical equipment. If possible increase the distance between the TV and the offending appliance. Or, shut one of them off.	
Poor or no color.	<ul style="list-style-type: none"> Sub-standard broadcast. Sub-standard cable signal. 	Try a different channel. Notify cable company of reception problem. If a VCR is connected, play a tape.	16/17
Picture wobbles or drifts.	<ul style="list-style-type: none"> RF not connected, loose. Local interference. 	Make or tighten connection. Try a different channel. Turn off interfering appliance.	8/9 16/17
No CATV reception.	<ul style="list-style-type: none"> Scrambled CATV channel. Cable not connected. Cable service interrupted. Antenna set, not CATV. 	Tune to unscrambled channel. Connect cable to Antenna/Cable (RF) jack. Contact cable service. Set Band/AFC to '1' in Installer menu, run Auto Program.	16/17 9/11 41 - 50
Normal picture, poor or no sound.	<ul style="list-style-type: none"> Audio muted. Pillow switch set to Pillow. Broadcast problem. A/V cables incorrectly connected. Audio Out cable wrong. 	Press MUTE or volume right key to increase sound level. Set to Normal for operation without pillow speaker. Try a different channel. Install A/V cables correctly. Install Matrix Out external amplifier/speaker cable correctly.	8/9 15 16/17 10/11/12 13
Snowy or Poor Picture.	<ul style="list-style-type: none"> Wrong Ant. connection/location. TV/VCR button set wrong. Wrong output channel selected. Loose connection. Broadcast problem. Video menu options set wrong. 	Move antenna, check connection/location. Set TV/VCR button on VCR correctly. Set output channels on all A/V equipment to same channel (3 or 4). Check that all connections are correct. Try another channel. Check Video menu brightness control.	12/15 10/11 8 - 15 16/17 32
TV turns Off.	<ul style="list-style-type: none"> Sleep Timer turned TV Off. Off Timer turned TV Off. Power failure. Power outlet controlled by switch. (Switch turned off.) 	Turn TV back On. Turn TV back On. Check other power outlets. Connect TV power cord to outlet that is not controlled by a switch.	16/17 16/17
TV turns On.	<ul style="list-style-type: none"> On Timer turned TV On. 	Disable On/Off Timer.	26
TV does not turn On/Off per On/Off Timer settings.	<ul style="list-style-type: none"> On/Off Timer option disabled. 	Go to Timer option in Setup menu and enable On/Off Timer. Check Timer On/Off settings.	26 26

Troubleshooting

Some Quick and Easy Tips for Resolving Problems

Symptom(s)	Possible Cause(s)	Possible Solution(s)	Page(s)
Parental Control Problems			
Patient has left Parental Control active, password is not known.	<ul style="list-style-type: none">Parental Control needs to be reset.	Press and hold down MENU key until menu disappears. Key in 9-8-7-6 and press CC. (For this to work, Installer menu item 0-1 Installer Seq needs to be set to 0.)	16 41
Protected/blocked message shows on-screen.	<ul style="list-style-type: none">Program content is restricted.	Key-in password and turn Lock On/Off (restrictions) Off. Set to Off in Lock On/Off menu.	34 - 37
	<ul style="list-style-type: none">Don't know password.	Tune to channel without Parental Control "Content" restrictions. Wait until block time expires.	34 - 37
TV - PG programs blocked.	<ul style="list-style-type: none">TV - PG set to be blocked.	Reset restrictions to PG - 13 so TV - PG programs will appear.	34 - 37
Foul language is heard.	<ul style="list-style-type: none">Foul language not blocked.	Restrict Language in Content options on Parental Control menu.	34 - 37
	<ul style="list-style-type: none">Program is not rated.	Restrict or block programs with no ratings.	34 - 37

Maintenance

Some suggestions for maintaining the optimum TV appearance

Routine TV Cabinet and Screen Cleaning

Careful and regular cleaning can extend the the useful service life of the TV. Be sure to turn the power off and pull out the power cord before you begin any cleaning.

Screen Cleaning

- Here's a great way to keep the dust off the screen for a while. Wet a soft cloth in a mixture of lukewarm water and a little fabric softener or dish washing detergent. Wring the cloth until it's almost dry, and then use it to wipe the screen.
- Make sure the excess water is off the screen, and then let it air-dry before turning it on.

Cabinet Cleaning

- Use a soft cloth with a mild soap solution to wipe the cabinet. (Avoid using any harsh, industrial strength variety of cleaner.)
- Rinse the cloth and wipe the cabinet again.
- Let the cabinet air-dry before turning the TV on.

Extended Absence

If the TV will be dormant for a long time, it's a good idea to unplug the power to protect against possible damage from lightning or power surges. If you use an off-air antenna, you may also want to disconnect it from the back of the TV.

If you unplug the TV, you may have to reset the clock using the Clock Set menu described earlier. See page 25.

Glossary

A list of definitions for some of the words found in this guide

75 OHM RF CABLE	The wire that comes from an off-air antenna or cable service provider. The end looks like a hex-shaped nut with a wire sticking through the middle. It screws onto the threaded jack on the back of the TV.
300 TO 75 OHM ADAPTER	A small device that connects a two-wire 300 ohm antenna to a 75 ohm RF jack. They are usually about an inch long with two screws on one end and a round opening with a wire sticking out on the other end.
A/V CABLES	Audio/Video cables are used for higher quality picture and sound from external A/V devices.
A/V DEVICE	Any device that produces video or sound (VCR, DVD, cable box, or television).
ADDED	Lets you add new channels to the list that the user can scroll through using CH (Channel) Up/Down.
AMPLIFIER	An electronic device that amplifies sound from a television, CD player, VCR, DVD, or other Audio/Video device.
ANTENNA	The physical receiver of television signals sent over the air. A large metal piece of equipment does not always have to be visible to be using an antenna.
AUTO PROGRAM	Auto Program has the TV automatically find all the channels available.
BLANK	Channels that are Blanked will not have Video (shows a blank screen) only audio, if present on channel. (Not available on digital channels.)
DELETED	Lets you remove channels from the list that the user will scroll through using CH (Channel) Up/Down.
DIGITAL AUDIO LANGUAGE	Other additional audio languages are available on some digital programs. Use for listening to audio in another language, such as Spanish or French.
DIGITAL TUNER	Receives a digital signal and turns it into picture and sound.
INPUT	Refers to an input jack that receives a signal from a TV, VCR, or other Audio/Video device.
JACK	A connection on the back of a TV, VCR, or other Audio/Video device.
MONO SOUND	Mono (monaural) sound is one channel of sound.
M.P.I. RJ11	Multiple Protocol Interface: ZENITH protocol for external control of TV through (M.P.I.) input jack on TV connections panel. (M.P.I. jack is used for cloning TV's features.)
OUTPUT	Refers to the output jack that sends a signal out of a VCR, DVD, or other A/V device.
SIGNAL	Picture and sound traveling through a cable, or over the air, to the television.
TUNER	Device that picks up the broadcast signal and turns it into picture and sound.
XDS	Extended Data Service: Additional program information included on the signal at the discretion of the broadcaster.

Notes

This page is available for the Installer to make notes as they relate to this TV set up

Zenith HealthView TV Warranty

HealthView Color TV Welcome to the LG family! We believe that you will be pleased with your new Zenith TV. Please read this warranty carefully, it is a "LIMITED WARRANTY" as defined under Federal Law. This warranty gives you specific legal rights, and you may also have other rights that vary from state-to-state within the U.S.A.

LG'S RESPONSIBILITY

Service Labor	During a period of one year from effective warranty date, LG will provide service labor by an LG authorized service center when needed, as determined by the LG service center, as a result of manufacturing defects.
Parts	New or remanufactured replacements for factory-defective parts will be supplied by an LG authorized service center for one year from effective warranty date (color picture tube — two years). Such replacement parts are warranted for the remaining portion of the original warranty period.
Warranty Service	Warranty service is available. (Some repairs may require the unit to be taken by the servicer to the repair facility and returned, at no additional charge.) Call 1-888-865-3026 for further information.
Not Covered	This warranty covers manufacturing defects and does not cover installation, adjustment of customer controls, installation or repair of antenna systems, cable converters or cable company-supplied equipment; it also does not cover damage due to misuse, abuse, negligence, acts of God or other causes beyond the control of LG. Any alteration of the product after manufacture voids this warranty in its entirety.

THIS WARRANTY IS IN LIEU OF ANY OTHER WARRANTY, EXPRESS OR IMPLIED, INCLUDING WITHOUT LIMITATION, ANY WARRANTY OF MERCHANTABILITY OR FITNESS FOR A PARTICULAR PURPOSE, AND LG SHALL NOT BE LIABLE FOR ANY CONSEQUENTIAL, INDIRECT, OR INCIDENTAL DAMAGES OF ANY KIND, INCLUDING LOST REVENUES OR PROFITS IN CONNECTION WITH THIS PRODUCT. SOME STATES DO NOT ALLOW LIMITATIONS ON HOW LONG AN IMPLIED WARRANTY LASTS OR THE EXCLUSION OR LIMITATION OF INCIDENTAL OR CONSEQUENTIAL DAMAGES, SO THE ABOVE LIMITATIONS OR EXCLUSIONS MAY NOT APPLY TO YOU.

OWNER'S RESPONSIBILITY

Effective Warranty Date	Warranty begins on the date of installation of the Direct-View TV. For your convenience, keep the dealer's dated bill of sale or delivery ticket as evidence of the purchase date.
Operating Guide	Read your Operating Guide carefully so that you will understand the operation of the TV and how to adjust the controls.
Antenna	Reception problems caused by inadequate antenna or faulty antenna connections are the owner's responsibility.
Warranty Service	For warranty service information, call 1-888-865-3026 . Parts and service labor that are LG's responsibility (see above) will be provided without charge. Other service is at the owner's expense. If you have any problem in obtaining satisfactory warranty service, call 1-888-865-3026 . You must provide the model number, serial number and date of purchase or date of original installation. Before you ask for warranty service, read "Maintenance and Troubleshooting" in the operating guide. You might avoid a service call.

For Customer Support/Service, please call:

1-888-865-3026

www.lgusa.com • www.zenith.com

LG Electronics U.S.A., Inc.
2000 Millbrook Drive
Lincolnshire, IL 60069

206-4065
Issue*
3828VA0518C