

User's Guide

L226WT
L226WTX
L226WTQ
L226WTG
L226WTM

Make sure to read the **Important Precautions** before using the product.
Keep the User's Guide(CD) in an accessible place for future reference.

See the label attached on the product and give the information to your dealer when you ask for service.

This unit has been engineered and manufactured to ensure your personal safety, however improper use may result in potential electrical shock or fire hazards. In order to allow the proper operation of all safeguards incorporated in this display, observe the following basic rules for its installation, use, and servicing.

On Safety

Use only the power cord supplied with the unit. In case you use another power cord, make sure that it is certified by the applicable national standards if not being provided by the supplier. If the power cable is faulty in any way, please contact the manufacturer or the nearest authorized repair service provider for a replacement.

The power supply cord is used as the main disconnection device. Ensure that the socket-outlet is easily accessible after installation.

Operate the display only from a power source indicated in the specifications of this manual or listed on the display. If you are not sure what type of power supply you have in your home, consult with your dealer.

Overloaded AC outlets and extension cords are dangerous. So are frayed power cords and broken plugs. They may result in a shock or fire hazard. Call your service technician for replacement.

Do not Open the Display.

- There are no user serviceable components inside.
- There are Dangerous High Voltages inside, even when the power is OFF.
- Contact your dealer if the display is not operating properly.

To Avoid Personal Injury :

- Do not place the display on a sloping shelf unless properly secured.
- Use only a stand recommended by the manufacturer.

To Prevent Fire or Hazards:

- Always turn the display OFF if you leave the room for more than a short period of time. Never leave the display ON when leaving the house.
- Keep children from dropping or pushing objects into the display's cabinet openings. Some internal parts carry hazardous voltages.
- Do not add accessories that have not been designed for this display.
- During a lightning storm or when the display is to be left unattended for an extended period of time, unplug it from the wall outlet.

On Installation

Do not allow anything to rest upon or roll over the power cord, and do not place the display where the power cord is subject to damage.

Do not use this display near water such as near a bathtub, washbowl, kitchen sink, laundry tub, in a wet basement, or near a swimming pool.

Displays are provided with ventilation openings in the cabinet to allow the release of heat generated during operation. If these openings are blocked, built-up heat can cause failures which may result in a fire hazard. Therefore, NEVER:

- Block the bottom ventilation slots by placing the display on a bed, sofa, rug, etc.
- Place the display in a built-in enclosure unless proper ventilation is provided.
- Cover the openings with cloth or other material.
- Place the display near or over a radiator or heat source.

Do not rub or strike the Active Matrix LCD with anything hard as this may scratch, mar, or damage the Active Matrix LCD permanently.

Do not press the LCD screen with your finger for a long time as this may cause some afterimages.

Some dot defects may appear as Red, Green or Blue spots on the screen. However, this will have no impact or effect on the display performance.

If possible, use the recommended resolution to obtain the best image quality for your LCD display. If used under any mode except the recommended resolution, some scaled or processed images may appear on the screen. However, this is characteristic of the fixed-resolution LCD panel.

On Cleaning

- Unplug the display before cleaning the face of the display screen.
- Use a slightly damp (not wet) cloth. Do not use an aerosol directly on the display screen because over-spraying may cause electrical shock.

On Repacking

- Do not throw away the carton and packing materials. They make an ideal container in which to transport the unit. When shipping the unit to another location, repack it in its original material.

On Disposal

- The fluorescent lamp used in this product contains a small amount of mercury.
- Do not dispose of this product with general household waste.
Disposal of this product must be carried out in accordance to the regulations of your local authority.

Connecting the speaker

1. Place the monitor with its front facing downward on a soft cloth.
2. Insert the protruding hook of the speaker in the direction of the slot in the back of the product.

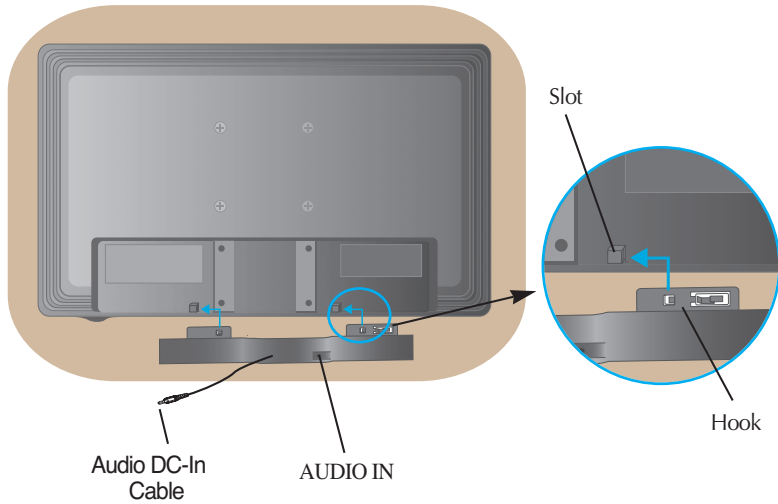

3. After setting up the speaker, connect the Audio DC-In Cable to the back of the product.

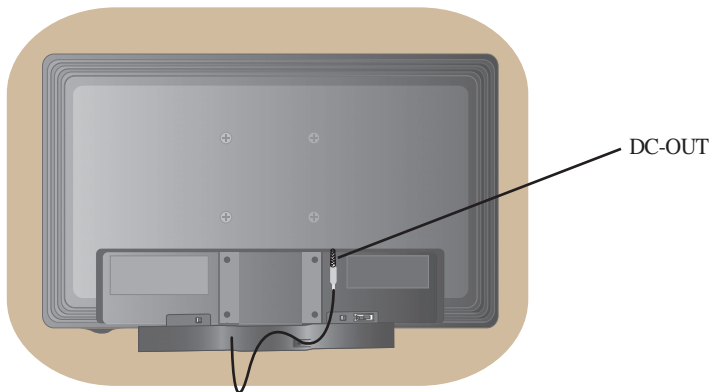

Connecting the Display

- Before setting up the monitor, ensure that the power to the monitor, the computer system, and other attached devices is turned off.

Connecting the stand

1. Place the monitor with its front facing downward on a soft cloth.
2. Assemble the Stand Body into the product in the correct direction as shown in the picture.
Make sure you push it until you hear it "click".

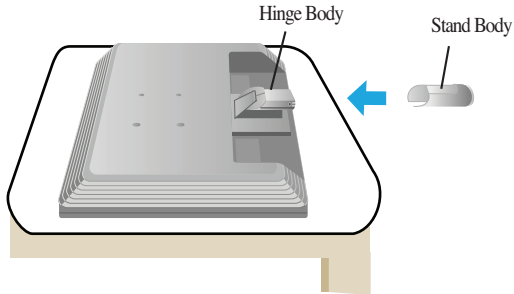

3. Assemble the Stand Base(Front, Rear) into the Stand Body in the correct direction.
4. Once assembled take the monitor up carefully and face the front side

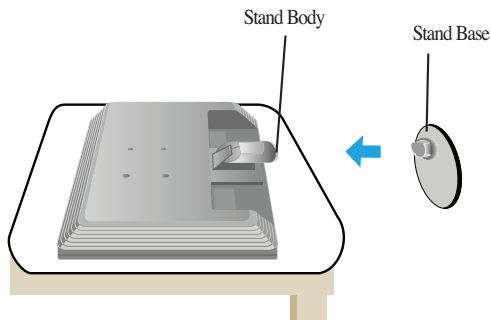

Important

- This illustration depicts the general model of connection. Your monitor may differ from the items shown in the picture.
- Do not carry the product upside down holding only the stand base. The product may fall and get damaged or injure your foot.

Disassembling the stand

Type. A

1. Put a cushion or soft cloth on a flat surface.



2. Place the monitor face Down on the cushion or soft cloth.



3. Pushing Latch inside, Take the stand base from stand body.



4. Separate the stand using a screwdriver as shown in the picture.

Note: Please keep the 4 screws in an accessible place for future use.

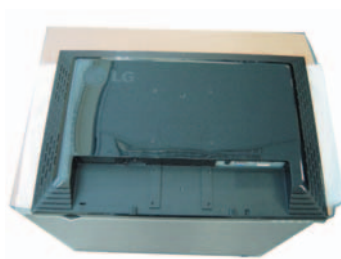

5. Pack up the product as shown in the picture.



Disassembling the stand

Type. B

1. Put a cushion or soft cloth on a flat surface.



2. Place the monitor face Down on the cushion or soft cloth.



3. Change your hold on the product as it follows and turn the Stand Base in the arrow direction.



4. Pull out the Stand to remove.



5. Pushing Latch inside, Take the stand base from stand body.



6. Pack up the product as shown in the picture.



Connecting the Display

- Before setting up the monitor, ensure that the power to the monitor, the computer system, and other attached devices is turned off.

Positioning your display

1. Adjust the position of the panel in various ways for maximum comfort.
 - Tilt Range : -5° ~ 20°

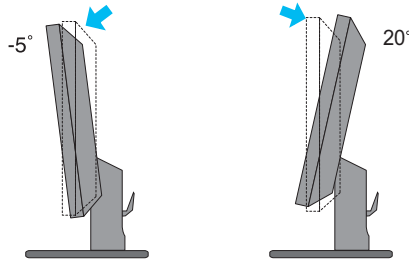

- Swivel : 355°

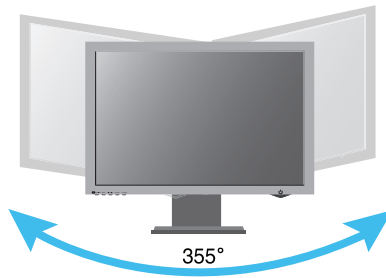



Ergonomic

It is recommended that in order to maintain an ergonomic and comfortable viewing position, the forward tilt angle of the monitor should not exceed 5 degrees.

Using the Computer

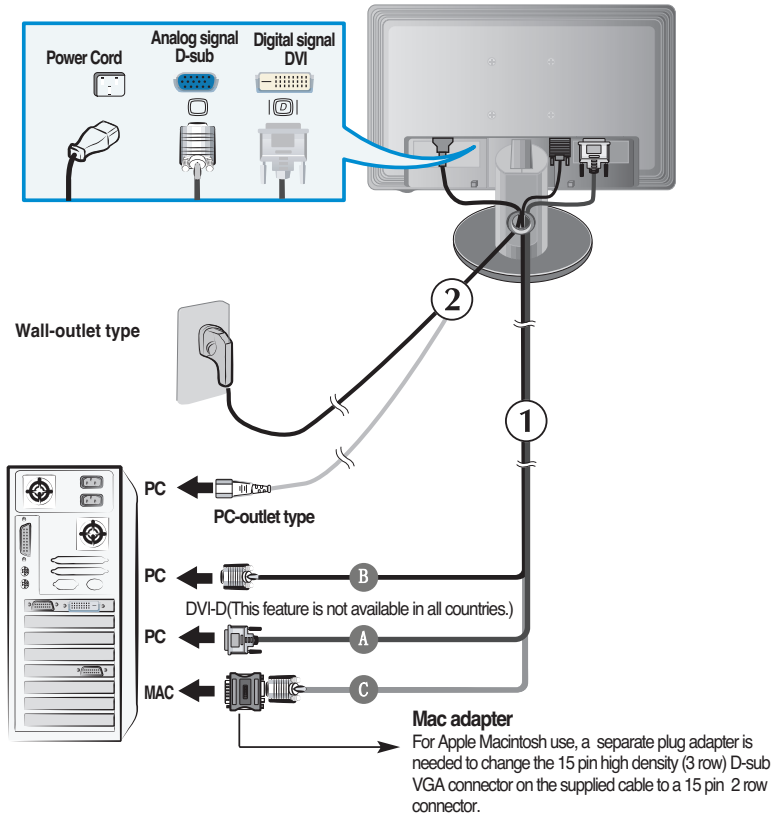
1. Make sure to turn off the computer and product. Connect the cable as below sketch map form ① to ②.
 - A Connect DVI Cable
 - B Connect Dsub Cable (PC)
 - C Connect Dsub Cable (Mac)



2. Press  button on the front switch panel to turn the power on.

When monitor power is turned on, the **'Self Image Setting Function'** is executed automatically.
(Only Analog Mode)

PROCESSING SELF
IMAGE SETTING

NOTE

'Self Image Setting Function'? This function provides the user with optimal display settings. When the user connects the monitor for the first time, this function automatically adjusts the display to optimal settings for individual input signals. If you want to adjust the monitor while in use, or wish to manually run this function once again, push the 'AUTO/SET' button on the front panel of the monitor. Otherwise, you may execute the 'Factory reset' option on the OSD adjustment menu. However, be aware that this option initializes all the menu items except 'Language'.

Side Jack

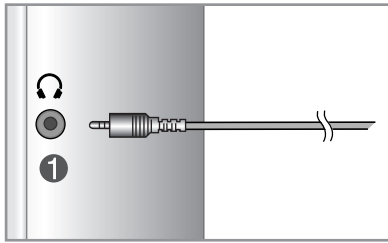

① Headphone/Earphone Input

Rear

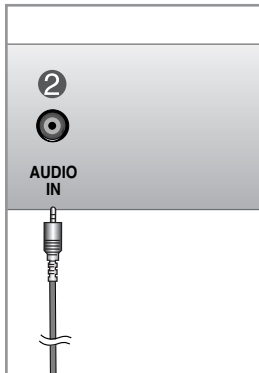

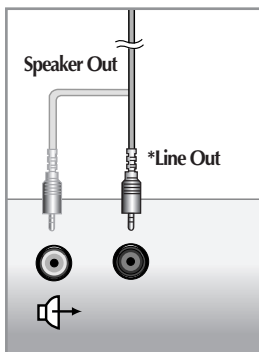

② Connects to the *LINE OUT jack of the PC sound card.



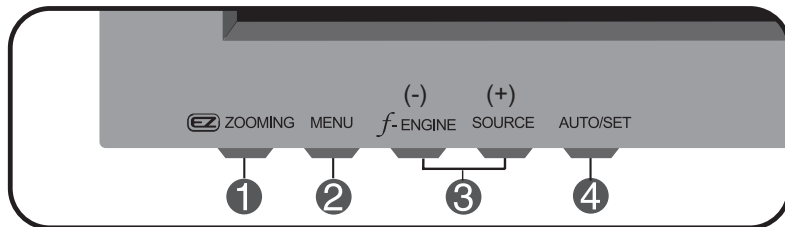
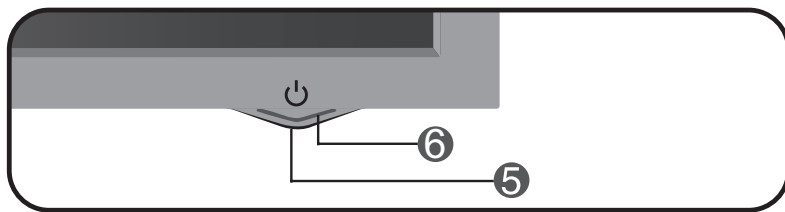

<Jack of the PC sound card>

Front Panel Controls

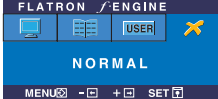

| Control | Function |
|---|---|
| <p>1  ZOOMING</p> | <p>At the current display, Use 'ez Zooming' Key, then the display resolution is transferred to the one step low resolution. Use 'ez Zooming' Key one more, the display is back to the original display.</p> <p>*Only One touch of ez-zoom, you can fine the best resolution you want and it is possible to magnify the size of characters and pictures for the old not having good eye sight, housewives not dealing with computer well and children.</p> <ul style="list-style-type: none"> ■ Recommend resolution are 1680 x 1050, 1280 x 1024, 1024 x 768, 800 x 600. ■ The setting method can differ by O/S or video card. In this case, Please ask to the computer or the video card manufacturer. |
| <p>2 MENU Button</p> <div style="display: flex; flex-direction: column; gap: 10px; margin-top: 10px;"> <div style="border: 1px solid black; background-color: #0070c0; color: white; padding: 2px 5px; text-align: center; font-size: 8px;">OSD LOCKED</div> <div style="border: 1px solid black; background-color: #0070c0; color: white; padding: 2px 5px; text-align: center; font-size: 8px;">OSD UNLOCKED</div> </div> | <p>Use this button to enter or exit the On Screen Display.</p> <p>OSD LOCKED/UNLOCKED</p> <p>This function allows you to lock the current control settings, so that they cannot be inadvertently changed. Press and hold the MENU button for several seconds. The message "OSD LOCKED" should appear.</p> <p>You can unlock the OSD controls at any time by pushing the MENU button for several seconds. The message "OSD UNLOCKED" should appear.</p> |

| Control | Function |
|--|---|
| <p>3 - + Buttons</p> <p>-  ENGINE</p> <p>+ SOURCE</p> | <p>Use these buttons to select or adjust functions in the On Screen Display.</p> <p>For more information, refer to page A17.</p>  <p>Use this button to make D-Sub or DVI connector active. This feature is used when two computers are connected to the display. The default setting is D-Sub.</p> |
| <p>4 AUTO/SET Button</p>  | <p>Use this button to enter a selection in the On Screen Display.</p> <p>AUTO IMAGE ADJUSTMENT</p> <p>When adjusting your display settings, always press the AUTO/SET button before entering the On Screen Display(OSD). This will automatically adjust your display image to the ideal settings for the current screen resolution size (display mode).</p> <p>The best display mode is</p> <p>22 inch monitor : 1680 x 1050</p> |
| <p>5 Power Button</p> | <p>Use this button to turn the display on or off.</p> |
| <p>6 Power Indicator</p> | <p>This Indicator lights up blue when the display operates normally(On Mode). If the display is in Sleep Mode (Energy Saving), this indicator color changes to amber.</p> |

Screen Adjustment

Making adjustments to the image size, position and operating parameters of the display is quick and easy with the On Screen Display Control system. A short example is given below to familiarize you with the use of the controls. The following section is an outline of the available adjustments and selections you can make using the OSD.

NOTE

- Allow the display to stabilize for at least 30 minutes before making image adjustments.

To make adjustments in the On Screen Display, follow these steps:

MENU → - + → AUTO/SET → - + → MENU

- 1** Press the **MENU Button**, then the main menu of the OSD appears.
- 2** To access a control, use the **- or + Buttons**. When the icon you want becomes highlighted, press the **AUTO/SET Button**.
- 3** Use the **- /+ Buttons** to adjust the image to the desired level. Use the **AUTO/SET Button** to select other sub-menu items.
- 4** Push the **MENU Button** once to return to the main menu to select another function. Push the **MENU Button** twice to exit from the OSD.

On Screen Display(OSD) Selection and Adjustment

The following table indicates all the On Screen Display control, adjustment, and setting menus.

| Main menu | Sub-menu | | A | D | Reference |
|---|-----------------|------------|---|---|---|
| PICTURE | BRIGHTNESS | | ● | ● | To adjust the brightness, contrast and gamma of the screen |
| | CONTRAST | | ● | ● | |
| | GAMMA | | ● | ● | |
| COLOR | PRESET | sRGB | ● | ● | To customize the color of the screen |
| | | 6500K | ● | ● | |
| | | 9300K | ● | ● | |
| | RED | | ● | ● | |
| | GREEN | | ● | ● | |
| | BLUE | | ● | ● | |
| POSITION | HORIZONTAL | | ● | | To adjust the position of the screen |
| | VERTICAL | | ● | | |
| TRACKING | CLOCK | | ● | | To improve the clarity and stability of the screen |
| | PHASE | | ● | | |
| | SHARPNESS | | ● | ● | |
| SETUP | LANGUAGE | | ● | ● | To customize the screen status for a user's operating environment |
| | OSD POSITION | HORIZONTAL | ● | ● | |
| | | VERTICAL | ● | ● | |
| | WHITE BALANCE | | ● | | |
| | POWER INDICATOR | | ● | ● | |
| | FACTORY RESET | | ● | ● | |
| FLATRON F-ENGINE | MOVIE /TEXT | | ● | ● | To select or customize desired image settings |
| | USER | | ● | ● | |
| | NORMAL | | ● | ● | |
| ● : Adjustable A : Analog Input D : Digital Input | | | | | |

NOTE

- The order of icons may differ depending on the model (A13~A17).

You were introduced to the procedure of selecting and adjusting an item using the OSD system. Listed below are the icons, icon names, and icon descriptions of the all items shown on the Menu.

Press the MENU Button, then the main menu of the OSD appears.

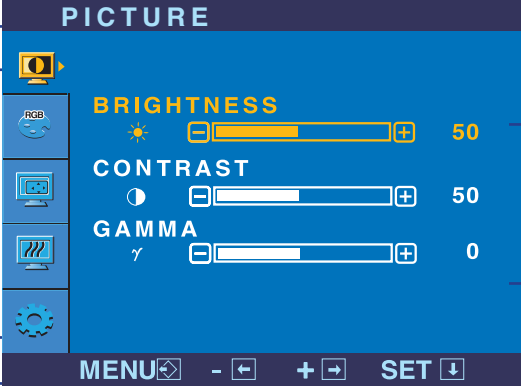

The screenshot shows the OSD menu with the following items:

- Menu Name:** PICTURE
- Icons:** A vertical list of icons on the left side: a monitor with a play button, an RGB icon, a monitor with a play button, a monitor with a play button, and a gear icon.
- Sub-menus:** BRIGHTNESS (value 50), CONTRAST (value 50), and GAMMA (value 0). Each sub-menu has a sun icon, a slider bar, and a plus/minus icon.
- Button Tip:** A legend at the bottom explains the navigation buttons: MENU (left arrow) for Exit, - + for Adjust (Decrease/Increase), SET (right arrow) for Enter, and a down arrow for Select another sub-menu.

NOTE

- OSD (On Screen Display) menu languages on the monitor may differ from the manual.

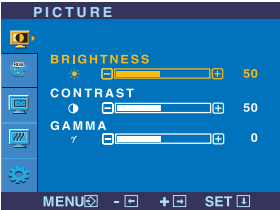
| Main menu | Sub menu | Description |
|--|--|--|
|  <h2>PICTURE</h2> | | |
|  | BRIGHTNESS CONTRAST GAMMA | <p>To adjust the brightness of the screen.</p> <p>To adjust the contrast of the screen.</p> <p>Set your own gamma value. : -50/0/50 On the monitor, high gamma values display whitish images and low gamma values display high contrast images.</p> |
| <ul style="list-style-type: none"> ■ MENU : Exit ■ - : Decrease ■ + : Increase ■ SET : Select another sub-menu | | |

| | | |
|--|--|--|
|  <h2>COLOR</h2> | | |
|  | PRESET RED GREEN BLUE | <ul style="list-style-type: none"> • sRGB: Set the screen color to fit the SRGB standard color specification. • 6500K: Slightly reddish white. • 9300K: Slightly bluish white. <p>Set your own red color levels.</p> <p>Set your own green color levels.</p> <p>Set your own blue color levels.</p> |
| <ul style="list-style-type: none"> ■ MENU : Exit ■ - : Decrease ■ + : Increase ■ SET : Select another sub-menu | | |

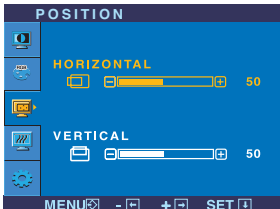
| | | |
|--|--------------------------------------|--|
|  <h2>POSITION</h2> | | |
|  | HORIZONTAL VERTICAL | <p>To move image left and right.</p> <p>To move image up and down.</p> |
| <ul style="list-style-type: none"> ■ MENU : Exit ■ - : Decrease ■ + : Increase ■ SET : Select another sub-menu | | |

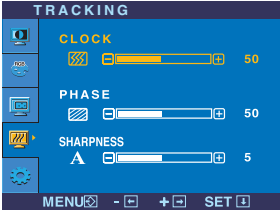
| Main menu | Sub menu | Description |
|---|---|--|
|  <p>TRACKING</p>  <ul style="list-style-type: none"> ■ MENU : Exit ■ - : Decrease ■ + : Increase ■ SET : Select another sub-menu | <p>CLOCK</p> <p>PHASE</p> <p>SHARPNESS</p> | <p>CLOCK To minimize any vertical bars or stripes visible on the screen background. The horizontal screen size will also change.</p> <p>PHASE To adjust the focus of the display. This item allows you to remove any horizontal noise and clear or sharpen the image of characters.</p> <p>SHARPNESS To adjust the clearness of the screen.</p> |

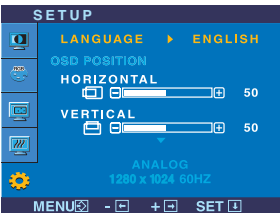
| | | |
|--|---|--|
|  <p>SETUP</p>  <ul style="list-style-type: none"> ■ MENU : Exit ■ - : Adjust ■ + : Adjust ■ SET : Select another sub-menu | <p>LANGUAGE</p> <p>OSD POSITION</p> <p>WHITE BALANCE</p> <p>POWER INDICATOR</p> <p>FACTORY RESET</p> | <p>LANGUAGE To choose the language in which the control names are displayed.</p> <p>OSD POSITION To adjust position of the OSD window on the screen.</p> <p>WHITE BALANCE If the output of the video card is different the required specifications, the color level may deteriorate due to video signal distortion. Using this function, the signal level is adjusted to fit into the standard output level of the video card in order to provide the optimal image. Activate this function when white and black colors are present in the screen.</p> <p>POWER INDICATOR Use this function to set the power indicator on the front side of the monitor to ON or OFF. If you set OFF, it will go off. If you set ON at any time, the power indicator will automatically be turned on.</p> <p>FACTORY RESET Restore all factory default settings except "LANGUAGE." Press the - button to reset immediately.</p> |
|--|---|--|

If this does not improve the screen image, restore the factory default settings. If necessary, perform the white balance function again. This function will be enabled only when the input signal is an analog signal.

On Screen Display(OSD) Selection and Adjustment

- ■ ■ The OSD screen will appear when you touch the **F-ENGINE** button on the monitor.

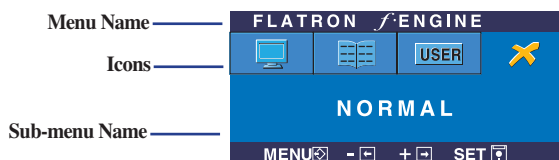

FLATRON F-ENGINE

When you execute F-ENGINE, two tones will appear on the screen as shown. The applied screen will appear on the left side, whereas the non-applied screen will appear on the right side. Touch the SET button to use the adjusted screen.

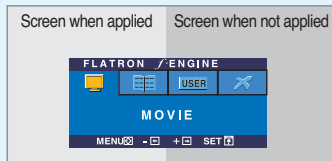

| Main menu | Sub menu | Description |
|-----------|----------|-------------|
|-----------|----------|-------------|

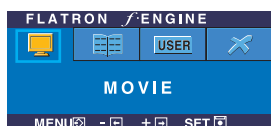

MOVIE TEXT This feature lets you easily select the best desired image condition optimized to the environment (ambient illumination, image types etc).
MOVIE: For animation images in videos or movies
TEXT: For text images (Word processing etc.)

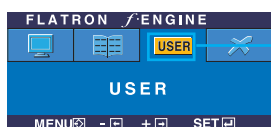

USER

User
 You can manually adjust brightness, ACE or RCM. You can save or restore the adjusted value even when using a different environment.

To adjust the **USER** sub-menu function, Press the **SET** Button

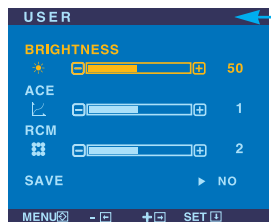

- ... (Brightness): Adjusts screen brightness.
- ...**ACE**(Adaptive Clarity Enhancer): Selects the clarity mode.
- ...**RCM**(Real Color Management): Selects the color mode.

- 0 Not applied
- 1 Green enhance
- 2 Flesh tone
- 3 Color Enhance

Select the **SAVE** sub-menu using the **SET** button and save the **YES** value using the **buttons**.

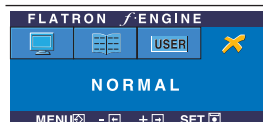

NORMAL This is under normal operating conditions.

Check the following before calling for service.

| No image appears | |
|---|--|
| <ul style="list-style-type: none">● Is the power cord of the display connected? | <ul style="list-style-type: none">• Check and see if the power cord is connected properly to the power outlet. |
| <ul style="list-style-type: none">● Is the power indicator light on? | <ul style="list-style-type: none">• Press the Power button. |
| <ul style="list-style-type: none">● Is the power on and the power indicator blue or green? | <ul style="list-style-type: none">• Adjust the brightness and the contrast. |
| <ul style="list-style-type: none">● Is the power indicator amber? | <ul style="list-style-type: none">• If the display is in power saving mode, try moving the mouse or pressing any key on the keyboard to bring up the screen.• Try to turn on the PC. |
| <ul style="list-style-type: none">● Do you see an "OUT OF RANGE" message on the screen? | <ul style="list-style-type: none">• This message appears when the signal from the PC (video card) is out of horizontal or vertical frequency range of the display. See the 'Specifications' section of this manual and configure your display again. |
| <ul style="list-style-type: none">● Do you see a "CHECK SIGNAL CABLE" message on the screen? | <ul style="list-style-type: none">• This message appears when the signal cable between your PC and your display is not connected. Check the signal cable and try again. |

| Do you see a "OSD LOCKED" message on the screen? | |
|---|--|
| <ul style="list-style-type: none">● Do you see "OSD LOCKED" when you push MENU button? | <ul style="list-style-type: none">• You can secure the current control settings, so that they cannot be inadvertently changed. You can unlock the OSD controls at any time by pushing the MENU button for several seconds: the message "OSD UNLOCKED" will appear. |

Display image is incorrect

- | | |
|---|--|
| <ul style="list-style-type: none">● Display Position is incorrect. | <ul style="list-style-type: none">• Press the AUTO/SET button to automatically adjust your display image to the ideal setting. If the results are unsatisfactory, adjust the image position using the H position and V position icon in the on screen display. |
| <ul style="list-style-type: none">● On the screen background, vertical bars or stripes are visible. | <ul style="list-style-type: none">• Press the AUTO/SET button to automatically adjust your display image to the ideal setting. If the results are unsatisfactory, decrease the vertical bars or stripes using the CLOCK icon in the on screen display. |
| <ul style="list-style-type: none">● Any horizontal noise appearing in any image or characters are not clearly portrayed. | <ul style="list-style-type: none">• Press the AUTO/SET button to automatically adjust your display image to the ideal setting. If the results are unsatisfactory, decrease the horizontal bars using the PHASE icon in the on screen display.• Check Control Panel --> Display --> Settings and adjust the display to the recommended resolution or adjust the display image to the ideal setting. Set the color setting higher than 24 bits (true color). |

Important

- Check **Control Panel --> Display --> Settings** and see if the frequency or the resolution were changed. If yes, readjust the video card to the recommend resolution.
- The setting method can differ by computer and O/S (Operation System), and resolution mentioned above may not be supported by the video card performance. In this case, please ask to the computer or the video card manufacturer.

Display image is incorrect

- | | |
|--|---|
| <ul style="list-style-type: none">● The screen color is mono or abnormal. | <ul style="list-style-type: none">• Check if the signal cable is properly connected and use a screwdriver to fasten if necessary.• Make sure the video card is properly inserted in the slot.• Set the color setting higher than 24 bits (true color) at Control Panel - Settings. |
| <ul style="list-style-type: none">● The screen blinks. | <ul style="list-style-type: none">• Check if the screen is set to interlace mode and if yes, change it to the recommend resolution.• Make sure the power voltage is high enough, It has to be higher than AC100-240V 50/60Hz. |

Have you installed the display driver?

- | | |
|--|---|
| <ul style="list-style-type: none">● Have you installed the display driver? | <ul style="list-style-type: none">• Be sure to install the display driver from the display driver CD (or diskette) that comes with your display. Or, you can also download the driver from our web site: http://www.lge.com. |
| <ul style="list-style-type: none">● Do you see an "Unrecognized monitor, Plug&Play (VESA DDC) monitor found" message? | <ul style="list-style-type: none">• Make sure to check if the video card supports Plug&Play function. |

| | | | |
|---------------------------------|---|---|-------------------------|
| Display | 22 inches (55.868 cm) Flat Panel Active matrix-TFT LCD Anti-Glare coating (L226WT/L226WTX/L226WTQ), Glare coating(L226WTG) 22 inches viewable 0.282*0.282 mm pixel pitch | | |
| Sync Input | Horizontal Freq. | Analog : 28 - 83 kHz (Automatic) Digital : 28 - 83 kHz (Automatic) | |
| | Vertical Freq. | 56 - 75 Hz (Automatic) | |
| | Input Form | Separate TTL, Positive/Negative SOG (Sync On Green) Digital | |
| Video Input | Signal Input | 15 pin D-Sub Connector DVI - D connector (Digital) | |
| | Input Form | RGB Analog (0.7 Vp-p/ 75 ohm), Digital | |
| Resolution | Max | Analog : VESA 1680 x 1050 @ 60 Hz Digital : VESA 1680 x 1050 @ 60 Hz | |
| | Recommend | VESA 1680 x 1050 @60 Hz | |
| Plug&Play | DDC 2B | | |
| Power Consumption | On Mode | : 45W(Typ.) | |
| | Sleep Mode | ≤ 1 W | |
| | Off Mode | ≤ 1 W | |
| Dimensions &Weight | | With Stand | Without Stand |
| | Width | 50.17 cm / 19.75 inches | 50.17 cm / 19.75 inches |
| | Height | 42.19 cm / 16.61 inches | 33.74 cm / 13.28 inches |
| | Depth | 23.39 cm / 9.21 inches | 5.95 cm / 2.34 inches |
| | Net | 5.65 kg (12.56 lbs) | |
| Tilt Range | Tilt | -5°~20° | |
| Power Input | AC 100-240V~ 50/60Hz 1.0A | | |
| Environmental Conditions | Operating Conditions | | |
| | Temperature | 10°C to 35 °C | |
| | Humidity | 10 % to 80 % non-Condensing | |
| | Storage Conditions | | |
| | Temperature | -20°C to 60 °C | |
| | Humidity | 5 % to 90 % non-Condensing | |
| Stand Base | Attached (<input type="checkbox"/>), Detached (<input type="checkbox"/>) | | |
| Signal cable | Attached (<input type="checkbox"/>), Detached (<input type="checkbox"/>) | | |
| Power cord | Wall-outlet type or PC-outlet type | | |

NOTE

- Information in this document is subject to change without notice.

| | | | |
|--|--|---|-------------------------|
| Display | 22 inches (55.868 cm) Flat Panel Active matrix-TFT LCD Anti-Glare coating 22 inches viewable 0.282*0.282 mm pixel pitch | | |
| Sync Input | Horizontal Freq. | Analog : 28 - 83 kHz (Automatic) Digital : 28 - 83 kHz (Automatic) | |
| | Vertical Freq. | 56 - 75 Hz (Automatic) | |
| | Input Form | Separate TTL, Positive/Negative SOG (Sync On Green) Digital | |
| Video Input | Signal Input | 15 pin D-Sub Connector DVI - D connector (Digital) | |
| | Input Form | RGB Analog (0.7 Vp-p/ 75 ohm), Digital | |
| Resolution | Max | Analog : VESA 1680 x 1050 @60 Hz Digital : VESA 1680 x 1050 @60 Hz | |
| | Recommend | VESA 1680 x 1050 @60 Hz | |
| Plug&Play | DDC 2B | | |
| Power Consumption (without speaker) | On Mode | : 45W(Typ.) | |
| | Sleep Mode | ≤ 1 W | |
| | Off Mode | ≤ 1 W | |
| Dimensions & Weight | With Stand | | Without Stand |
| | Width | 50.17 cm / 19.75 inches | 50.17 cm / 19.75 inches |
| | Height | 42.19 cm / 16.61 inches | 37.14 cm / 14.62 inches |
| | Depth | 23.39 cm / 9.21 inches | 5.95 cm / 2.34 inches |
| | Net | 5.85 kg (13 lbs) | |
| Tilt Range | Tilt -5°~20° | | |
| Power Input | AC 100-240V~ 50/60Hz 1.0A | | |
| Environmental Conditions | Operating Conditions | | |
| | Temperature | 10°C to 35 °C | |
| | Humidity | 10 % to 80 % non-Condensing | |
| | Storage Conditions | | |
| Temperature | -20°C to 60 °C | | |
| Humidity | 5 % to 90 % non-Condensing | | |
| Stand Base | Attached (<input type="checkbox"/>), Detached (<input type="checkbox"/>) | | |
| Signal cable | Attached (<input type="checkbox"/>), Detached (<input type="checkbox"/>) | | |
| Power cord | Wall-outlet type or PC-outlet type | | |
| Audio | RMS Audio Output | 1W+1W(R+L) | |
| | Input Sensitivity | 0.7Vrms | |
| | Speaker Impedance | 16Ω | |

NOTE

- Information in this document is subject to change without notice.

Preset Modes (Resolution)

| Display Modes (Resolution) | | Horizontal Freq. (kHz) | Vertical Freq. (Hz) |
|----------------------------|-------------|------------------------|---------------------|
| 1 | 720 x 400 | 31.468 | 70 |
| 2 | 640 x 480 | 31.469 | 60 |
| 3 | 640 x 480 | 37.500 | 75 |
| 4 | 800 x 600 | 37.879 | 60 |
| 5 | 800 x 600 | 46.875 | 75 |
| 6 | 1024 x 768 | 48.363 | 60 |
| 7 | 1024 x 768 | 60.123 | 75 |
| 8 | 1152 x 864 | 67.500 | 75 |
| 9 | 1280 x 1024 | 63.981 | 60 |
| 10 | 1280 x 1024 | 79.976 | 75 |
| 11 | 1680 x 1050 | 64.674 | 60 |
| *12 | 1680 x 1050 | 65.290 | 60 |

*Recommend Mode

Indicator

| MODE | LED Color |
|------------|-----------|
| On Mode | blue |
| Sleep Mode | amber |
| Off Mode | Off |

Installing the Wall mount plate

This monitor satisfies the specifications of the Wall mount plate or the interchange device.

1. Place the monitor with its front facing downward on a soft cloth.



2. Separate the stand using a screwdriver as shown in the picture.

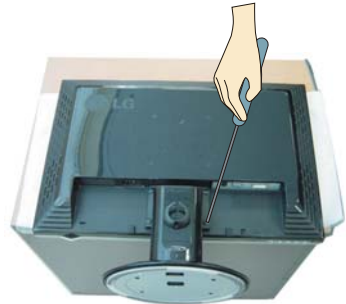

3. Install the Wall mount plate.

Wall mount plate(Seperate purchase)

This is stand-type or wall mount type and is connectable with Wall mount plate. Please refer to the installation guide for more details, which is provided when Wall mount plate is purchased.

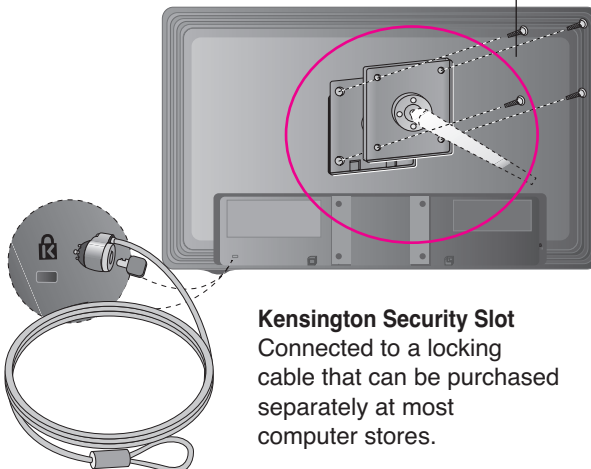

Kensington Security Slot
Connected to a locking cable that can be purchased separately at most computer stores.

Digitally yours ■■■■■.....

