

<http://www.lg.ca>



Unique Features	Full HD up-scaling (1080p)	Portable In
	View Full HD picture quality with simple setup.	Listen to music from your portable device (MP3, Notebook, etc).
	Go to page 10	Go to page 19

P/NO : MFL42932933

Safety Precaution



CAUTION
RISK OF ELECTRIC SHOCK
DO NOT OPEN



CAUTION: TO REDUCE THE RISK OF ELECTRIC SHOCK DO NOT REMOVE COVER (OR BACK) NO USER-SERVICEABLE PARTS INSIDE REFER SERVICING TO QUALIFIED SERVICE PERSONNEL.



This lightning flash with arrowhead symbol within an equilateral triangle is intended to alert the user to the presence of uninsulated dangerous voltage within the product's enclosure that may be of sufficient magnitude to constitute a risk of electric shock to persons.



The exclamation point within an equilateral triangle is intended to alert the user to the presence of important operating and maintenance (servicing) instructions in the literature accompanying the product.

WARNING: TO PREVENT FIRE OR ELECTRIC SHOCK HAZARD, DO NOT EXPOSE THIS PRODUCT TO RAIN OR MOISTURE.

WARNING: Do not install this equipment in a confined space such as a book case or similar unit.

CAUTION: Do not block any ventilation openings. Install in accordance with the manufacturer's instructions.

Slots and openings in the cabinet are provided for ventilation and to ensure reliable operation of the product and to protect it from overheating.

The openings should never be blocked by placing the product on a bed, sofa, rug or other similar surface. This product should not be placed in a built-in installation such as a bookcase or rack unless proper ventilation is provided or the manufacturer's instruction have been adhered to.

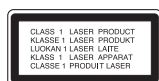

CAUTION:

This product employs a Laser System.

To ensure proper use of this product, please read this owner's manual carefully and retain it for future reference. Should the unit require maintenance, contact an authorized service center.

Use of controls, adjustments or the performance of procedures other than those specified herein may result in hazardous radiation exposure.

To prevent direct exposure to laser beam, do not try to open the enclosure. Visible laser radiation when open. **DO NOT STARE INTO BEAM.**

FCC WARNING: This equipment may generate or use radio frequency energy. Changes or modifications to this equipment may cause harmful interference unless the modifications are expressly approved in the instruction manual. The user could lose the authority to operate this equipment if an unauthorized change or modification is made.

REGULATORY INFORMATION: FCC Part 15

This equipment has been tested and found to comply with the limits for a Class B digital device, pursuant to Part 15 of the FCC Rules. These limits are designed to provide reasonable protection against harmful interference when the product is operated in a residential installation.

This product generates, uses, and can radiate radio frequency energy and, if not installed and used in accordance with the instruction manual, may cause harmful interference to radio communications. However, there is no guarantee that interference will not occur in a particular installation. If this product does cause harmful interference to radio or television reception, which can be determined by turning the product off and on, the user is encouraged to try to correct the interference by one or more of the following measures:

- Reorient or relocate the receiving antenna.
- Increase the separation between the product and receiver.
- Connect the product into an outlet on a circuit different from that to which the receiver is connected.
- Consult the dealer or an experienced radio/TV technician for help.

- Labelling information:

This device complies with Part 15 of the FCC rules.

Operation is subject to the following two conditions: (1) This device may not cause harmful interference, and (2) This device must accept any interference received, including interference that may cause undesired operation.

- RF Exposure Statement:

The antenna(s) used for this transmitter must be installed to provide a separation distance of at least 20 cm from all persons and must not be collocated or operating in conjunction with any antenna or transmitter other than those contained in this device.

This Class B digital apparatus complies with Canadian ICES-003, Issue 2, and RSS-210, Issue 4 (Dec. 2000).

"To prevent radio interference to the licensed service, this device is intended to be operated indoors and away from windows to provide maximum shielding. Equipment (or its transmit antenna) that is installed outdoors is subject to licensing."

Cet appareil numérique de la classe B est conforme à la norme NMB-003, No. 2, et CNR-210, No. 4 (Dec. 2000).

<< Pour empêcher que cet appareil cause du brouillage au service faisant l'objet d'une licence, il doit être utilisé à l'intérieur et devrait être placé loin des fenêtres afin de fournir un écran de blindage maximal. Si le matériel (ou son antenne d'émission) est installé à l'extérieur, il doit faire l'objet d'une licence.>>

Operation is subject to the following two conditions:

this device may not cause interference, and (2) this device must **accept any interference**, including interference that may cause undesired operation of the device.

The term "IC:" before the certification/registration number only signifies that the Industry Canada technical specifications were met.

IMPORTANT SAFETY INSTRUCTIONS

1. Read these instructions.
2. Keep these instructions.
3. Heed all warnings.
4. Follow all instructions.
5. Do not use this apparatus near water.
6. Clean only with dry cloth.
7. Do not block any ventilation openings. Install in accordance with the manufacturer's instructions.
8. Do not install near any heat sources such as radiators, heat registers, stoves, or other apparatus (including amplifiers) that produce heat.
9. Do not defeat the safety purpose of the polarized or grounding-type plug. A polarized plug has two blades with one wider than the other. A grounding type plug has two blades and a third grounding prong. The wide blade or the third prong are provided for your safety. If the provided plug does not fit into your outlet, consult an electrician for replacement of the obsolete outlet.
10. Protect the power cord from being walked on or pinched particularly at plugs, convenience receptacles, and the point where they exit from the apparatus.
11. Only use attachments/accessories specified by the manufacturer.
12. Use only with the cart, stand, tripod, bracket, or table specified by the manufacturer, or sold with the apparatus. When a cart is used, use caution when moving the cart/apparatus combination to avoid injury from tip-over.



13. Unplug this apparatus during lightning storms or when unused for long periods of time.
14. Refer all servicing to qualified service personnel. Servicing is required when the apparatus has been damaged in any way, such as power-supply cord or plug is damaged, liquid has been spilled or objects have fallen into the apparatus, the apparatus has been exposed to rain or moisture, does not operate normally, or has been dropped.

Copyrights

It is forbidden by law to copy, broadcast, show, broadcast via cable, play in public, or rent copyrighted material without permission. This product features the copy protection function developed by Macrovision. Copy protection signals are recorded on some discs. When recording and playing the pictures of these discs picture noise will appear. This product incorporates copyright protection technology that is protected by method claims of certain U.S. patents and other intellectual property rights owned by Macrovision Corporation and other rights owners. Use of this copyright protection technology must be authorized by Macrovision Corporation, and is intended for home and other limited viewing uses only unless otherwise authorized by Macrovision Corporation. Reverse engineering or disassembly is prohibited.

CONSUMERS SHOULD NOTE THAT NOT ALL HIGH DEFINITION TELEVISION SETS ARE FULLY COMPATIBLE WITH THIS PRODUCT AND MAY CAUSE ARTIFACTS TO BE DISPLAYED IN THE PICTURE. IN CASE OF 525 PROGRESSIVE SCAN PICTURE PROBLEMS, IT IS RECOMMENDED THAT THE USER SWITCH THE CONNECTION TO THE 'STANDARD DEFINITION' OUTPUT. IF THERE ARE QUESTIONS REGARDING OUR TV SET COMPATIBILITY WITH THIS MODEL 525p UNIT, PLEASE CONTACT OUR CUSTOMER SERVICE CENTER.

Welcome to your new DVD Receiver

Contents

Setting up	5-7
LED indicator of Wireless Transmitter	8
LED indicator of Wireless Receiver	8
Setting an ID of Wireless Transmitter	8
Hooking up the unit	9-10
Remote control	11
Main Unit	12
Adjust the settings	13-14
Setting the sound mode	14
Displaying Disc Information	15
Playing a disc or file	15-17
Viewing photo files	18
Listening to the radio	18
Listening to music from your USB device	19
Listening to music from your portable player	19
Controlling your TV with the supplied Remote Control	20
Language Codes	21
Area Codes	21
Troubleshooting	22
Types of Playable Discs	23
Specifications	24



What is SIMPLINK?

Some functions of this unit are controlled by TV's remote control when this unit and LG TV with SIMPLINK are connected through HDMI connection.

- Controllable functions by LG TV's remote control; Play, Pause, Scan, Skip, Stop, Power Off, etc.
- Refer to the TV owner's manual for the details of SIMPLINK function.
- LG TV with SIMPLINK function has the logo as shown above.
- Use a higher version cable than 1.2A HDMI cable.

CAUTION: The apparatus should not be exposed to water (dripping or splashing) and no objects filled with liquids, such as vases, should be placed on the apparatus.

CAUTION concerning the Power Cord

Most appliances should be placed on a dedicated circuit;

That is, a single outlet circuit which powers only that appliance and has no additional outlets or branch circuits. Check the specification page of this owner's manual to be certain. Do not overload wall outlets. Overloaded wall outlets, loose or damaged wall outlets, extension cords, frayed power cords, or damaged or cracked wire insulation are dangerous. Any of these conditions could result in electric shock or fire. Periodically examine the cord of your appliance, and if its appearance indicates damage or deterioration, unplug it, discontinue use of the appliance, and have the cord replaced with an exact replacement part by an authorized servicer. Protect the power cord from physical or mechanical abuse, such as being twisted, kinked, pinched, closed in a door, or walked upon. Pay particular attention to plugs, wall outlets, and the point where the cord exits the appliance. To disconnect power from the unit, unplug the unit from the outlet. When installing the product, ensure that the plug is easily accessible.

Setting up

The speakers are detached from the speaker stands.

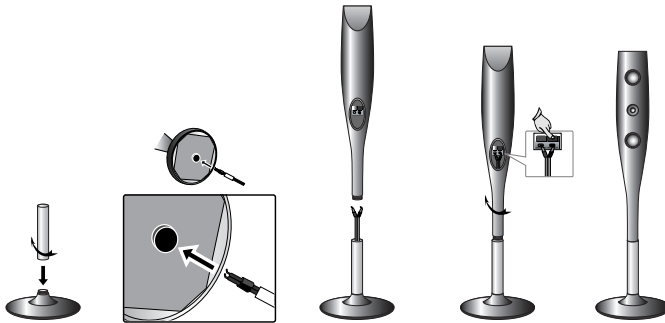

Assembling to the Speakers

- 1** Fix the post to the base by rotating the post. And Draw the speaker cord through the hole on the base.
- 2** Draw the speaker cord through the hole on the speaker.
- 3** Fix the speaker to the stand by rotating the speaker. Connect the speaker cord to the appropriate terminals on the speaker.

Attaching the speakers to the DVD receiver

- 1** **You will have received 4 speaker cables.**
Each one is color-coded by a band near each end and connects one of the 4 speakers to the DVD receiver.
- 2** **Connect the wires to the DVD receiver.**
Match each wire's colored band to the same colored connection terminal on the rear of the DVD receiver. To connect the cable to the DVD receiver, press each plastic finger pad to open the connection terminal. Insert the wire and release the finger pad.

Connect the red end of each wire to the terminals marked +(plus) and the black end to the terminals marked - (minus).

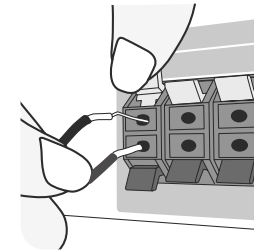

- 3** **Connect the wires to the speakers.**
Connect the other end of each wire to the correct speaker according to the color coding:

COLOR	SPEAKER	POSITION
Green	Center	Above screen, directly in front of you.
Orange	Sub Woofer	
Red	Front	In front of you, to the right of the screen.
White	Front	In front of you, to the left of the screen.

To connect the cable to the speakers, press each plastic finger pad to open the connection terminals on the base of each speaker. Insert the wire and release the finger pad.

Setting up

Attaching the speakers to the Wireless Receiver

- 1 Connect the power cord of the Wireless Receiver to the outlet.
- 2 Connect the wires to the Wireless Receiver.
Connect the Wireless Receiver and the rear speaker (right, left) with the speaker cable.

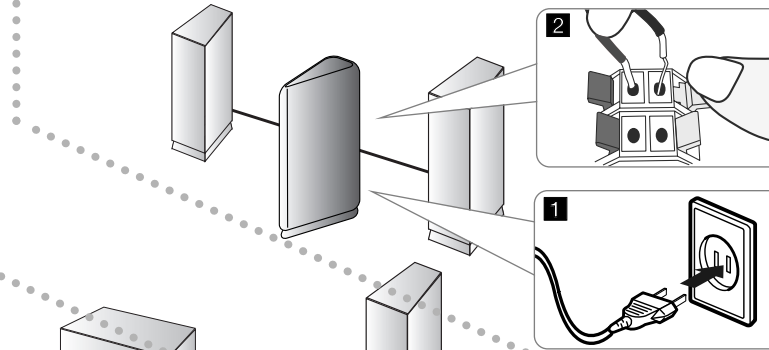

Attaching the Wireless Transmitter to the DVD receiver

- 1 Connect the DC power cable to the unit and transmitter.
- 2 Connect the SOUND SIGNAL connector of the Wireless Transmitter and rear (right, left) speaker of the main set with the sound signal cable.

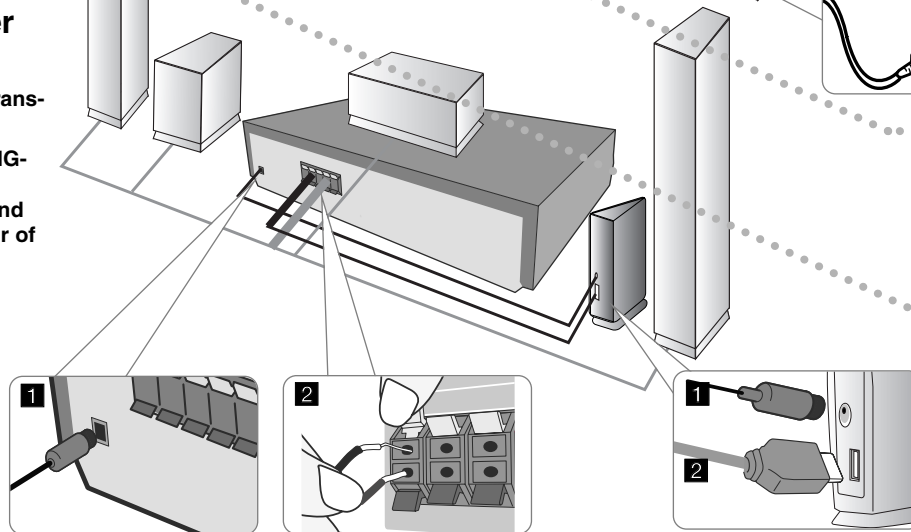

Be careful of the following

- Be careful to make sure children do not put their hands or any objects into the *speaker duct.
- *Speaker duct: A hall for plentiful bass sound on speaker cabinet(enclosure).
- Set the distance between this unit and Wireless Receiver within 10m.
- Optimum performance can be implemented only when the Wireless Transmitter and the Wireless Receiver within distance of 2m to 10m is used since communication failure may occur if longer distance is used.
- Be sure to match the speaker cable to the appropriate terminal on the components: + to + and - to -. If the cables are reversed, the sound will be distorted and will lack bass.
- It takes a few seconds (and may take longer) for the Wireless Transmitter and Wireless Receiver to communicate with each other.
- When the unit is turned off, the Wireless Transmitter is in standby mode (off) automatically after about 10 seconds.
- If the Wireless Transmitter is turned off, the Wireless Receiver will not function.

About Ferrite Core

Be sure to attach the ferrite core to the speaker cable (for connecting to this unit and wireless receiver).

This ferrite core can reduce noises.

How to attach the ferrite core

- 1 Press the stopper [a] of the ferrite core to open.
- 2 Wind the speaker cables once on the ferrite core. (Refer to the fig.3 and comment.).
- 3 Close the ferrite core until it clicks.

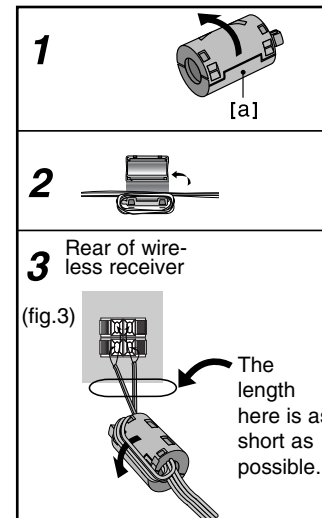

LED indicator of Wireless Transmitter

LED color	Operation
BLUE	The main set is turned on, everything is connected and transmitting.
RED	The wireless transmitter is in standby mode.
OFF (No display)	The DC cable is disconnected to the unit.

LED indicator of Wireless Receiver

LED color	Operation
BLUE	The Wireless Receiver is receiving the signal of the Wireless transmitter.
RED	The Wireless Receiver is in standby mode.
OFF (No display)	The Wireless Receiver is turned off.

Setting an ID of Wireless Transmitter

When the unit is manufactured, the ID is already set. If an interference occurs or you use a new Wireless Receiver, an ID is set again.

	ON Wireless Kit
1 Connect the SOUND SIGNAL connector of the transmitter and the rear (right, left) speaker terminals of main unit with the SOUND SIGNAL cable.:	-
2 Connect the DC cable to the unit and transmitter.:	-
3 Turn off the Wireless Receiver:	POWER Switch
4 Press the ID. for more than 3 seconds: The Blue LED indicator will quickly flicker	ID.
5 Turn on the Wireless Receiver:	POWER Switch

Be careful of the following

If there is a strong electromagnetic wave product nearby, interference may occur. Put the unit (Wireless Receiver and main unit) away from there. (Ex: Microwave oven)

If there is no audio signal for longer than 10 minutes, the Wireless Receiver and Wireless Transmitter will automatically switch to standby mode. In power saving mode, both LEDs will turn red. LEDs will turn blue when there is any audio signal back.

If you operate main unit then wireless speakers (rear speakers) sound within a few seconds in standby mode.

Hooking up the unit

- 1 Connect jacks on the unit and your TV (DVD player or Digital Device etc.) using the cables.

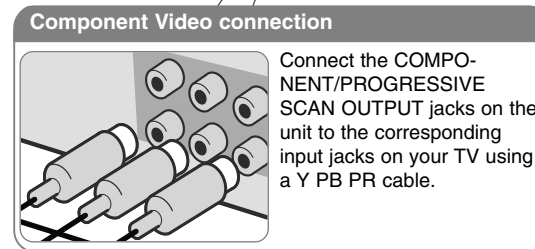
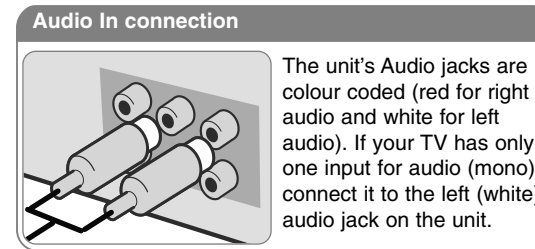
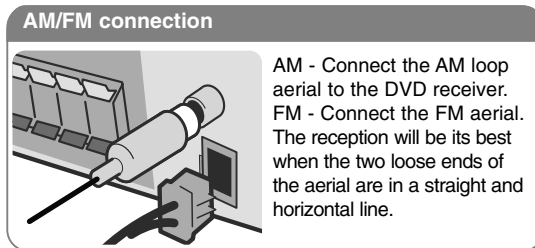
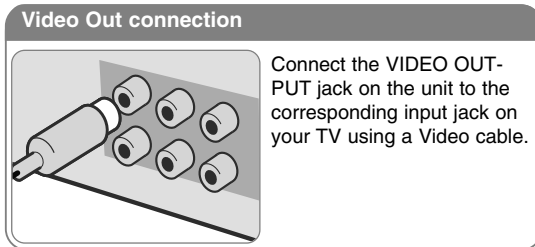

- 2 Plug the power cord into the power source.

Hooking up the unit

HDMI Out connection

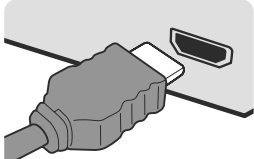

Connect the HDMI OUTPUT jack on the unit to the HDMI input jack on an HDMI compatible TV using an HDMI cable. Set the TV's source to HDMI. In stop mode, select HDMI mode by pressing HDMI.

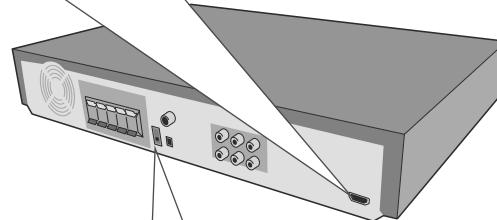

Digital Audio in connection

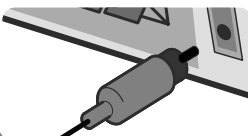

Connect the unit's OPTICAL IN jack to the optical out jack on your TV (or Digital Device etc.)

Hooking up the unit - more function

Resolution Setting

You can change the resolution for component video and HDMI output.
Press RESOLUTION repeatedly to select the desired resolution - 480i, 480p, 720p, 1080i, 1080p
The resolution may not be selected depending on the connection or TV.

Available resolution according to connection

[HDMI OUT]: 1080p, 1080i, 720p and 480p
[COMPONENT VIDEO OUT]: 1080i, 720p, 480p and 480i
[VIDEO OUT]: 480i

Notes on HDMI connection

- If the picture does not appear on the screen with the analog video connections, change the resolution to 480i.
- For 720p and 1080i resolution on the component video out, only non-copy protected discs can be played back. If the disc is copy protected, it will be displayed at the 480p(NTSC) resolution.
- 1080p, 1080i, 720p and 480p does not work with the analog video connections (MONITOR OUT).
- If you change the resolution, the display MENU (MP3/JPEG/DivX) size is changed.
- If your TV does not accept your resolution setting, abnormal picture appears on the screen. Please read owner's manual for TV, and then set the resolution that your TV can accept.

Enjoying audio from an external source

You can enjoy audio from an external source through your DVD receiver.
Press AUX repeatedly to select the desired input source. - AUX, AUX OPT, AUDIO IN

Remote control

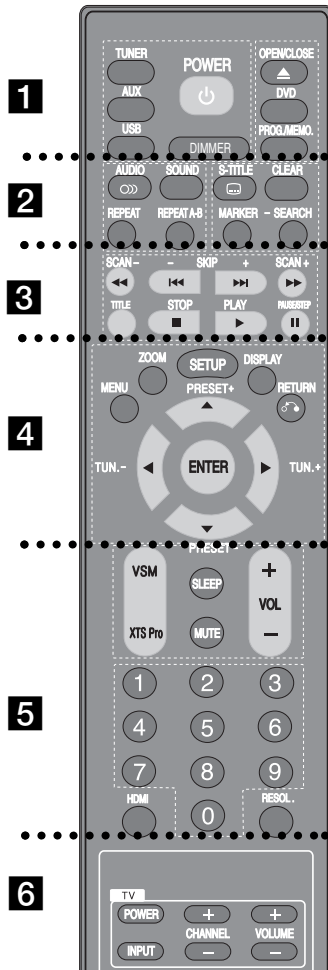

- • • • • **1** • • • • •
- TUNER** : Selects the System's tuner (FM and AM bands).
- AUX** : Changes the input source (AUX, AUX OPT, PORTABLE)
- USB** : Plays the multimedia files.
- DIMMER** : Changes brightness of the display window on the front panel during power-on status.
- OPEN/CLOSE** (▲) : Opens and closes the disc tray.
- DVD** : Selects the function (DVD/CD)
- PROG./MEMO.** : Accesses or removes Program menu.
- POWER** : Switches the unit ON or OFF.
- • • • • **2** • • • • •
- AUDIO** : Selects an audio language (DVD) or an audio channel (CD).
- SOUND** : Selects the sound mode.
- S-TITLE** : During playback ,S - TITLE repeatedly to select a desired subtitle language.
- CLEAR** : Removes a track number on the Program List.
- REPEAT** : Repeats a Chapter/ Track/ Title/ all.
- REPEAT A-B** : Repeats sequence.
- MARKER** : Marks a point during playback.
- SEARCH** : Displays MARKER SEARCH menu.
- • • • • **3** • • • • •
- SCAN**(◀◀ / ▶▶) : Search backward or forward.
- SKIP**(◀◀◀ / ▶▶▶) : Go to next or previous chapter/ track.
- TITLE** : If the current DVD title has a menu, the title menu appears on the screen. Otherwise, the disc menu may appear.
- STOP** (■) : Stops playback.
- PLAY** (▶) : Starts playback
- PAUSE/STEP** (||) : Pause playback.
- • • • • **4** • • • • •
- MENU** : Accesses the menu on a DVD disc.
- ZOOM** : Watching an enlarged video image
- SETUP** : Accesses or removes setup menu
- DISPLAY** : Accesses On-Screen Display.

- RETURN** (↶) : Press to move backwards in the menu.
- PRESET(-/+)** : Selects programed station of Radio.
- TUN.(-/+)** : Tunes in the desired radio station.
- ENTER** : Acknowledges menu selection.
- ◀ / ▶ / ▲ / ▼ (left/right/up/down)** :Used to navigate on-screen displays.
- • • • • **5** • • • • •
- VSM** : Press **VSM** to set the VIRTUAL sound.
- XTS Pro** : Supplies more natural and realistic sound. Supplies great sound effect.
- SLEEP** : Sets the System to turn off automatically at a specified time.
- MUTE** : Press MUTE to mute your unit. You can mute your unit in order, for example, to answer the telephone.
- VOLUME (+/-)** : Adjusts speaker volume.
- 0-9 numerical buttons** : Selects numbered options in a menu.
- HDMI** : Switches the HDMI mode to HDMI (active) and OFF (inactive).
- RESOLUTION (RESOL.)**: Changes the resolution depending on your TV.
- • • • • **6** • • • • •
- TV Control buttons** : Controls the TV. See the page 20.

Put the batteries into the remote control
 Make sure that the + (plus) and – (minus) on the batteries match those on the remote control.

Main Unit

Open/Close

DVD/CD Disc Drawer

PORT. IN port

The PORT. In port means you can connect a audio device to play trough the surround sound speakers.

Power

Turn the unit on and off.

USB port

The USB port allows you can connect a memory device to your DVD player.

Func., Play

Press and hold down this button for about 3 seconds then press repeatedly to select other function.

Pause

Mono/Stereo(St.)

Stop

Tuning (-/+)
Skip / Search

Volume

Control the volume when using any function.

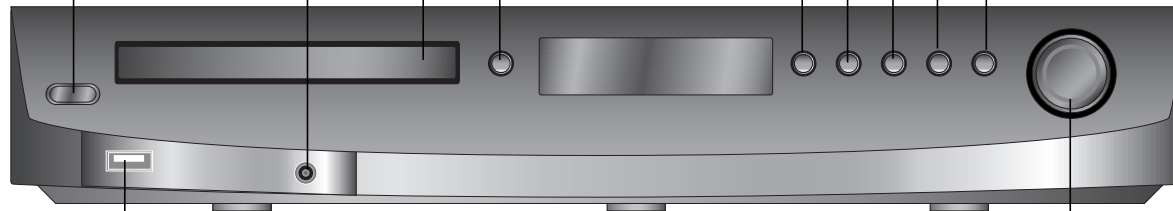

Adjust the settings	
	ON REMOTE
1 Display setup menu :	SETUP
2 Select a desired option on the first level:	▲▼
3 Move to second level:	▶
4 Select a desired option on the second level:	▲▼
5 Move to third level:	▶
6 Change the setting:	▲▼, ENTER

Adjust the settings - more function

Adjust the language settings

OSD – Select a language for the Setup menu and on-screen display.

Disc Menu/Audio/Subtitle – Select a language for the Menu/Audio/Subtitle.

[Original]: Refers to the original language in which the disc was recorded.

[Others]: To select another language, press number buttons then ENTER to enter the corresponding

4-digit number according to the language code list in the reference chapter (see page 21). If you make a mistake before pressing ENTER, press CLEAR.

[OFF] (for Disc Subtitle): Turn off Subtitle.

Adjust the display settings

TV Aspect – Select which screen aspect to use based on the shape of your TV screen.

[4:3]: Select when a standard 4:3 TV is connected.

[16:9]: Select when a 16:9 wide TV is connected.

Display Mode – If you selected 4:3, you'll need to define how you would like widescreen programs and films to be displayed on your TV screen.

[Letterbox]: This displays a widescreen picture with black bands at the top and bottom of the screen.

[Panscan]: This fills the entire 4:3 screen, cropping the picture as necessary.

5.1 Speaker Setup	
	ON REMOTE
1 Open the settings menu:	SETUP
2 Scroll to the audio icon:	▲▼
3 Scroll right to enter the audio menu, then select 5.1 Speaker Setup:	▶ ▲▼ ENTER
4 Highlight the speaker you want to adjust:	◀▶
	
5 Move between the options and change the settings:	▲▼◀▶
6 Set the output level (volume) of a speaker: Anywhere between -5dB and +5dB. Size : Since the speaker setting are fixed, you cannot change the setting.	◀▶
7 Set the distance each Speaker is away from your set watching position. This ensures that all sound reaches you perfectly synchronised. You cannot adjust the front or subwoofer speakers.	◀▶
8 Test the signals of each speaker: Adjust the volume to your taste according to these signals.	◀▶
9 Save your settings and exit the Setup menu:	ENTER

Adjust the audio settings

DRC (Dynamic Range Control) – Make the sound clear when the volume is turned down (Dolby Digital only). Set to [On] for this effect.

Vocal – Select [On] to mix karaoke channels into normal stereo. This function is effective for multi-channel karaoke DVDs only.

HD AV Sync - Sometimes Digital TV encounters a delay between picture and sound. If this happens you can compensate by setting a delay on the sound so that it effectively 'waits' for the picture to arrive: this is called HD AV Sync. Use ▲▼ to scroll up and down through the delay amount, which you can set at anything between 0 and 300m sec.

The delay will vary depending on which digital TV channel you are on. If you change the channel you may need to readjust the HD AV Sync.

Adjust the lock settings

To access the lock options, you must enter the 4-digit password. If you have not yet entered a password you are prompted to do so. Enter a 4-digit password. Enter it again to verify. If you make a mistake while entering the number, press CLEAR to delete numbers.

If you forget your password you can reset it. Press SETUP to display the Setup menu. Input '210499' and press ENTER. The password has now been cleared.

Rating – Select a rating level. The lower the level, the stricter the rating. Select [Unlock] to deactivate the rating.

Password – Sets or changes the password for lock settings.

[New]: Enter a new 4-digit password using the numerical buttons then press ENTER. Enter the password again to confirm.

[Change]: Enter the new password twice after entering the current password.

Area code – Select a code for a geographic area as the playback rating level. This determines which area's standards are used to rate DVDs controlled by the parental lock. See the Area Codes on page 21.

Adjust the others settings

PBC (Playback Control) – Playback control provides special navigation features that are available on some Video CDs. Select [On] to use this feature.

DivX(R) Registration – We provide you with the DivX® VOD (Video On Demand) registration code that allows you to rent and purchase videos using the DivX® VOD service.

For more information, visit www.divx.com/vod.

Press ENTER when [Select] icon is highlighted and you can view the registration code of the unit.

Setting the sound mode

Switch on XTS/XTS Pro Sound

XTS allows you to get the best sound quality for whatever you are watching. Press the **XTS Pro** button repeatedly to cycle through the three options: XTS On, XTS Pro On, Normal.

XTS - Use XTS when the bass of an original soundtrack is weak by enhancing the subwoofer. It also splits the sound evenly between the front and rear speakers.

XTS-P - This optimizes the audio signal in balanced frequency response and enhances the speakers' performance. XTS Pro also recognizes Dolby Digital, Pro Logic II, and DTS surround-sound processing modes.

Set a pre-programmed sound field

This system has a number of pre-set surround sound fields. Select the one which best suits the program you are watching by pressing SOUND repeatedly to cycle through the options: Bypass, On Stage, Studio, Club, Hall, Theatre, Church, Movie, Music, Matrix.

VSM (VIRTUAL SOUND MATRIX)

You can select the Virtual sound. Press VSM to set the virtual sound.

2Ch source

[ON STAGE] mode: Simulates a large Concert hall

[VIRTUAL] mode: Realtime 3D positioned sound rendering technology with stereo sources, optimized for stereo speakers. Listeners may experience amazing virtual surround effects with their own multimedia players.

5.1Ch source

[VIRTUAL] mode: The Multichannel sound changes the sound in 5.1 ch into a virtual one in the 10.1 ch so that it provides such a feeling that you listen to the sound simultaneously from the right and left speakers and center speaker.

Displaying Disc Information

	ON REMOTE
1 Press DISPLAY:	DISPLAY
2 Select a item:	▲▼
3 Adjust the Display menu settings:	◀▶
4 To return the exit:	DISPLAY

Displaying Disc Information - more function

You can select an item by pressing ▲▼ and change or select the setting by pressing ▶▶.

	Current title (or track) number/total number of titles (or tracks)
	Current chapter number/total number of chapters
	Elapsed playing time
	Selected audio language or channel
	Selected subtitle
	Selected angle/total number of angles
	Selected sound mode
	Moving to another GROUP (in case of DVD Audio Disc)
	Viewing another PAGE (in case of DVD Audio Disc)

Symbol Used in this Manual

All discs and files listed below	ALL	MP3 files	MP3
DVD and finalized DVD±R/RW	DVD	WMA files	WMA
Video CDs	VCD	DivX files	DivX
Audio CDs	ACD		

Playing a Disc or file

	ON REMOTE
1 Open the disc tray:	OPEN/CLOSE
2 Insert a Disc: (On unit)	-
3 Close the disc tray:	OPEN/CLOSE
4 Adjust the menu settings: or Select a file from the menu:	▲▼▶▶ ▲▼
5 Start the Disc playing:	▶ PLAY
6 To stop the Disc playing:	■ STOP

Playing a Disc or file - more function

Playing a DVD or Video CD that has a menu **DVD** **VCD**

Most DVDs or Video CD now have menus which load first before the film begins to play. You can navigate these menus using ▲▼▶▶ to highlight an option. Press ENTER to select.

Skip to the next/previous chapter/track **ALL**

Press SKIP (▶▶) to move to the next chapter/track.
Press SKIP (◀◀) to return to the beginning of the current chapter/track.
Press SKIP (◀◀) twice briefly to step back to the previous chapter/track.

Pause playback **ALL**

Press PAUSE/STEP (||) to pause playback. Press PLAY (▶) to continue playback.

Frame-by-Frame playback **DVD** **DivX** **VCD**

Press PAUSE/STEP (||) repeatedly to play title Frame-by-Frame.

Playing repeatedly **ALL**

Press REPEAT repeatedly to select an item to be repeated. The current title, chapter or track will be played back repeatedly. To return to normal playback, press REPEAT repeatedly to select [OFF]. This function does not operate during Video CD playback, change the PBC to OFF on setup menu.

Fast forward or fast reverse **ALL**

Press SCAN (◀◀ or ▶▶) to play fast forward or fast reverse during playback. You can change the playback speed by pressing SCAN (◀◀ or ▶▶) repeatedly. Press PLAY (▶) to continue play at normal speed.

Selecting a subtitle language **DVD** **DivX**

During playback, press S-TITLE (⏏) repeatedly to select a desired subtitle language.

Slow down the playing speed **DVD** **VCD**

While playback is paused, press SCAN (◀◀ or ▶▶) to slow down, go forward or reverse playback. You can change the various playback speed by pressing SCAN (◀◀ or ▶▶) repeatedly. Press PLAY (▶) to continue play at normal speed. The video CD cannot be slow down reverse playback.

Watch and listen 1.5 times faster **DVD** **VCD** **ACD** **MP3** **WMA**

Press PLAY when a DVD is already playing to watch and listen to a DVD 1.5 times faster than normal playback speed. ▶x1.5 will appear in the top right corner of the screen. Press PLAY again to return to normal playback speed.

Viewing the Title menu **DVD**

Press TITLE to display the disc's title menu, if available.

Viewing the DVD MENU **DVD**

Press MENU to display the disc menu, if available.

Starting play from selected time **DVD** **DivX** **VCD**

Searches for the starting point of entered time code. Press DISPLAY during playback and select the time clock icon. Input the required start time in hours, minutes, and seconds and press ENTER. If you enter the wrong number, press CLEAR to enter again.

Last Scene Memory **DVD**

This unit memorizes the last scene from the last disc that is viewed. The last scene remains in memory even if you remove the disc from the player or switch off(Stand-by mode) the unit. If you load a disc that has the scene memorized, the scene is automatically recalled.

Mixed disc or USB Flash Drive – DivX, MP3/WMA and JPEG

When playing a disc or USB Flash Drive containing DivX, MP3/WMA and JPEG files together, you can select which menu of files you would like to play by pressing TITLE

Changing the character set to display DivX® subtitle correctly **DivX**

If the subtitle does not display properly during playback, press and hold S-TITLE for about 3 seconds then press S-TITLE to select another language code until the subtitle is displayed properly

DivX file requirement **DivX**

DivX disc compatibility with this player is limited as follows:

- Available resolution size: 800x600 (W x H) pixel
- The file name of the DivX subtitle is available by 45 characters.
- If the cords is impossible code to express in the DivX file, it may be displayed as " _ " mark on the display.
- If the number of the screen frame is over 30 per 1 second, this unit may not operate normally.
- If the video and audio structure of recorded files are not interleaved, either video or audio is outputted.
- The file name of the DivX subtitle is available by 45 characters.
- If the name of movie file is different from that of the subtitle file,during playback of a DivX file, subtitle may not be displayed.
- MPEG4 file extensions: ".avi", ".mpg", ".mpeg"
- Playable DivX subtitle: SubRip(*.srt/* .txt) ,SAMI(*.smi), SubStation Alpha(*.ssa/* .txt) MicroDVD(*.sub/* .txt) SubViewer 2.0(*.sub/* .txt) (Files (VobSub(.sub) included with USB device is not supported SubViewer 2.0 (.sub/.txt), TMPlayer(.txt), DVD Subtitle System(.txt)
- Playable Codec format: "MP43", "3IV1 ", "3IV2"
- Playable Audio format: "AC3", "PCM", "MP3"
- Sampling frequency: within 32 - 48 kHz (MP3), within 24 - 48kHz (WMA)
- Bit rate: within 32 - 320kbps (MP3), 40 - 192kbps (WMA)
- CD-R/RW, DVD±R/RW Format: ISO 9660
- Maximum Files/Disc: Less than 999 (total number of files and folders)

Creating your own program **ACD** **MP3** **WMA**

You can play the contents of a disc in the order you want by arranging the order of the music files on the disc. The program is cleared when the disc is removed. Select a desired music file then press PROG./MEMO. or select " " and then press ENTER to add the music file to the program list. To add all music files on the disc, select " " and then press ENTER. Select a music file from the program list then press ENTER to start programmed playback. To clear a music file from the program list, select the music file you want to clear then press CLEAR or select " " icon and then press ENTER. To clear all music files from the program list, select " " then press ENTER.

Displaying file information (ID3 TAG) **MP3** **WMA**

While playing an MP3 file containing file information, you can display the information by pressing DISPLAY repeatedly.

MP3/WMA music file requirement

MP3/WMA compatibility with this unit is limited as follows:

- File extensions: ".mp3", ".wma".
- Sampling frequency: within 32 - 48 kHz (MP3), within 24 - 48kHz (WMA)
- Bit rate: within 32 - 320kbps (MP3), 40 - 192kbps (WMA)
- CD-R/RW, DVD±R/RW Format: ISO 9660
- Maximum Files/Disc: Less than 999 (total number of files and folders)

Screen Saver

The screen saver appears when you leave the unit in Stop mode for about five minutes.

Repeating a specific portion (A-B) **DVD**

Press REPEAT A-B at the beginning of the portion you wish to repeat and again at the end of the portion. Your selected portion will be repeated continually. To return to normal playback, press REPEAT A-B to select [OFF].

Hearing a different audio **DVD** **DivX**

During playback, press AUDIO () repeatedly to switch between the available audio languages or encoding methods.

Watching a enlarged video image **DVD**

During playback or pause mode, press ZOOM to enlarge the video image (3 steps). You can move through the zoomed picture using ◀▶▲▼ buttons. Press CLEAR to exit.

Slow down the playing speed **DVD**

While playback is paused, press SCAN(◀◀ or ▶▶) to slow down, go forward or reverse playback. You can change the various playback speed by pressing SCAN (◀◀ or ▶▶) repeatedly. Press PLAY (▶) to continue play at normal speed.

Marking a favorite scene **DVD** **DivX**



You can mark positions by pressing MARKER at the desired position for up to 9 markers. Also you can recall or clear positions by pressing SEARCH. Use ◀ or ▶ to select a desired marker, then press ENTER to recall it or CLEAR to clear it.

Viewing photo files

	ON REMOTE
1 Open the disc tray: (On unit: ▲)	OPEN/CLOSE
2 Insert a disc: (On unit)	-
3 Close the disc tray: (On unit: ▲)	OPEN/CLOSE
4 Select a photo file:	▲▼
5 Display the selected file in full screen:	ENTER
6 To return to the menu:	■ STOP

Viewing photo files - more function

Viewing photo files as a slide show

Use ▲▼◀▶ to highlight () icon then press ENTER to start slide show. You can change slide show speed using ◀▶ when () icon is highlighted.

Skip to the next/previous photo

Press SKIP (◀◀ or ▶▶) to view the previous/next photo.

Rotate a photo

Use ▲▼◀▶ to rotate the photo in full screen mode.

Pause a slide show

Press PAUSE/STEP (⏸) to pause a slide show. Press PLAY (▶) to continue the slide show.

Photo file requirement

JPEG file compatibility with this unit is limited as follows:

- File extensions: ".jpg"
- Photo size: Less than 2MB recommended
- CD-R/RW, DVD±R/RW Format: ISO 9660
- Maximum Files/Disc: Less than 999 (total number of files and folders)

Listening to the radio

Be sure that both FM and AM aerials are connected.

	ON REMOTE
1 Turn the power on:	POWER
2 Select either FM or AM:	TUNER
3 Select a radio station:	TUN-/+
4 To 'save' a radio station: A preset number will show in the display.	PROG/MEMO.
5 To select a 'saved' station input the preset number: Up to 50 radio stations can be saved.	PRESET-/+
6 To confirm press:	PROG/MEMO.

Listening to the radio - more function

Look for radio stations automatically

Press and hold TUN.-/TUN.+ for more than a second. The tuner will scan automatically and stop when it finds a radio station.

Choose a preset number for a radio station

When storing a radio station, the preset number can be chosen. When the player automatically shows a preset number, press PRESET -/+ to change it. Press PROG./MEMO. to save your chosen number.

Delete all the saved stations

Press and hold PROG./MEMO for two seconds. ERASE ALL will flash up on the DVD receiver display. Press PROG./MEMO to erase all saved radio stations.

Improve poor FM reception

Press PAUSE (MONO/ST) on the front panel. This will change the tuner from stereo to mono and usually improve the reception.

Listening to music from your USB device

The advantage of connecting your portable USB player through the system's USB port is that the USB device can be controlled from the system.

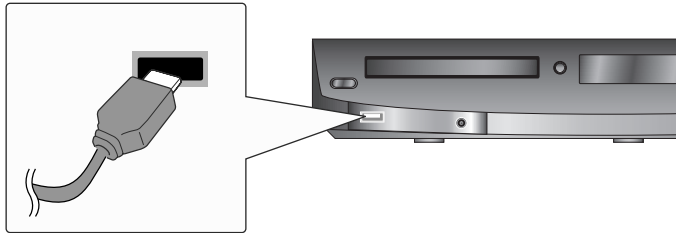

	ON REMOTE
1 Connect the USB device to the unit using a USB cable (not supplied).:	-
2 Select the USB function:	USB
3 Select a file from the menu:	▲ ▼
4 Start your music playing:	▶
5 Before disconnecting the portable USB device, change to any other function by pressing:	DVD or TUNER
6 Remove the USB device:	-

Listening to music from your USB device - more function

Compatible USB Devices

- Devices which require additional program installation when you have connected it to a computer, are not supported.
- MP3 Player : Flash type MP3 player.
The MP3 player requiring installation of a driver is not supported.
- USB Flash Drive : Devices that support USB1.0 or USB1.1.

USB device requirement

- **Do not extract the USB device while in operation.**
- To prevent data loss, back up all data.
- If you use a USB extension cable or USB hub, the USB device might not be recognized.
- A device using NTFS file system is not supported. (Only FAT (16/32) file system is supported.)
- The USB function of this unit does not support all USB devices.
- Digital camera and mobile phone are not supported.
- This unit does not supported more than 999 files.
- If the connected USB device has two or more folders, a drive folder is displayed on the screen. If you want to move to the previous menu after you select a folder, press RETURN.

Listening to music from your portable player

The player can be used to play the music from many types of portable players.

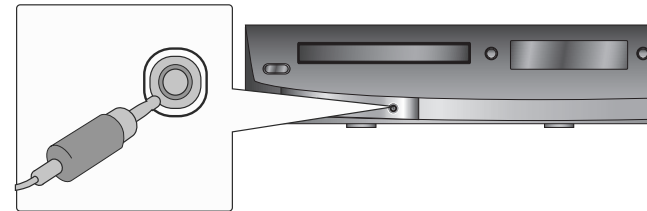

	ON REMOTE
1 Connect the portable player by plugging the unit into PORT. IN on the front of the player.:	-
2 Turn the power on:	POWER
3 Select the PORTABLE function:	AUX
4 Turn the portable player on and start it playing:	-

Controlling your TV with the supplied Remote Control

You can control the sound level, input source, TV's channel and power switch of your LG TV with the supplied remote control.

Controlling other TV's with the remote control

You can control the sound level, input source, TV's channel and power switch of non-LG TVs as well. If your TV is listed in the table, set the appropriate manufacturer code. While holding down TV POWER button, press the number buttons to select the manufacturer code for your TV. Release TV POWER button.

Manufacturer	Code Number	Manufacturer	Code Number
ADMIRAL	16,33,37,44,45	MONTGOMERY	01,06,08,09
AIWA	70	WARD	23,24,32,33,34
AKAI	01	NEC	01,08
AMARK	09	NOBLEX	07
AOC	01	PACKARD BELL	43
BELL & HOWELL	33	PANASONIC	07,11,13,25,35,36
BROKSONIC	18,19	PHILCO	01,06,07,08,09, 15,38,43,58
CANDLE	51	PHILIPS	06,07,43,61,62,65
CCE	07	PIONEER	30
CENTURION	08	PORTLAND	09
CINERAL	43	PROSCAN	03,37,44
CITIZEN	49,50,51,52,53,54,55	QUASAR	11,13
CORONADO	09	RADIO SHACK	16,17,23
CROWN	09	RCA	01,03,37,44,69
CURTIS MATHES	01,03,08,33,35,37,44	REALISTIC	16,17,23
DAEWOO	16,38,39,40,41,42,43	SAMPO	08
DAYTRON	01,08	SAMSUNG	01,08,09,25,68
EMERSON	01,09,16,17,18,19	SANYO	28,29
FISHER	28,29	SCOTT	01,08
FUNAI	46,47	SEARS	09,25,26,27,28,29
GENERAL ELECTRIC	03,10,11,13,37,44	SEMP	64
GRADIENTE	01,56,57,63,67	SHARP	09,22,23,24,60,66
HITACHI	09,14,15,43	SIGNATURE 2000	01,06,08,09,10, 23,24,33,34
JC PENNEY	01,08,10,27,35	SONY	12,62
JVC	20,21,63,67	SOUNDESIGN	51
KIOTE	43	SYLVANIA	01,04,05,06,07, 08,35,51
KMC	09	SYMPHONIC	46,47
KTV	01,08,09,31	TATUNG	11
LG (GOLDSTAR)	01,07,08,09,35,39,40	TEKNIKA	07,09,16,33,51
LODGENET	33	TELERENT	09,33
LOGIK	33	THOMSON	69
LXI	09,24,25,26,27,28,29	YORX	08
MAGNAVOX	01,02,04,05,06, 07,08,09,20, 34,35,43,51,61,62,65	TOSHIBA	01,25,26,27,64
MAJESTIC	33	WARDS	01,06,08,09,10,33,34
MARANTZ	01,32	XR1000	48
MEMOREX	33	ZENITH	01,02,33,59
MGA/MITSUBISHI	01,08,32,34		

Language Codes

Use this list to input your desired language for the following initial settings: Disc Audio, Disc Subtitle, Disc Menu.

Language	Code	Language	Code	Language	Code	Language	Code	Language	Code	Language	Code
Afar	6565	Croatian	7282	Hausa	7265	Lingala	7678	Quechua	8185	Tajik	8471
Afrikaans	6570	Czech	6783	Hebrew	7387	Lithuanian	7684	Rhaeto-Romance	8277	Tamil	8465
Albanian	8381	Danish	6865	Hindi	7273	Macedonian	7775	Rumanian	8279	Telugu	8469
Ameharic	6577	Dutch	7876	Hungarian	7285	Malagasy	7771	Russian	8285	Thai	8472
Arabic	6582	English	6978	Icelandic	7383	Malay	7783	Samoan	8377	Tonga	8479
Armenian	7289	Esperanto	6979	Indonesian	7378	Malayalam	7776	Sanskrit	8365	Turkish	8482
Assamese	6583	Estonian	6984	Interlingua	7365	Maori	7773	Scots Gaelic	7168	Turkmen	8475
Aymara	6588	Faroeese	7079	Irish	7165	Marathi	7782	Serbian	8382	Twi	8487
Azerbaijani	6590	Fiji	7074	Italian	7384	Moldavian	7779	Serbo-Croatian	8372	Ukrainian	8575
Bashkir	6665	Finnish	7073	Javanese	7487	Mongolian	7778	Shona	8378	Urdu	8582
Basque	6985	French	7082	Kannada	7578	Nauru	7865	Sindhi	8368	Uzbek	8590
Bengali; Bangla	6678	Frisian	7089	Kashmiri	7583	Nepali	7869	Singhalese	8373	Vietnamese	8673
Bhutani	6890	Galician	7176	Kazakh	7575	Norwegian	7879	Slovak	8375	Volapük	8679
Bihari	6672	Georgian	7565	Kirghiz	7589	Oriya	7782	Slovenian	8376	Welsh	6789
Breton	6682	German	6869	Korean	7579	Panjabi	8065	Spanish	6983	Wolof	8779
Bulgarian	6671	Greek	6976	Kurdish	7585	Pashto, Pushto	8083	Sudanese	8385	Xhosa	8872
Burmese	7789	Greenlandic	7576	Laothian	7679	Persian	7065	Swahili	8387	Yiddish	7473
Byelorussian	6669	Guarani	7178	Latin	7665	Polish	8076	Swedish	8386	Yoruba	8979
Chinese	9072	Gujarati	7185	Latvian, Lettish	7686	Portuguese	8084	Tagalog	8476	Zulu	9085

Area Codes







Choose a area code from this list.

Area	Code	Area	Code	Area	Code	Area	Code	Area	Code
Afghanistan	AF	Costa Rica	CR	Greenland	GL	Maldives	MV	Paraguay	PY
Argentina	AR	Croatia	HR	Hong Kong	HK	Mexico	MX	Philippines	PH
Australia	AU	Czech Republic	CZ	Hungary	HU	Monaco	MC	Poland	PL
Austria	AT	Denmark	DK	India	IN	Mongolia	MN	Portugal	PT
Belgium	BE	Ecuador	EC	Indonesia	ID	Morocco	MA	Romania	RO
Bhutan	BT	Egypt	EG	Israel	IL	Nepal	NP	Russian Federation	RU
Bolivia	BO	El Salvador	SV	Italy	IT	Netherlands	NL	Saudi Arabia	SA
Brazil	BR	Ethiopia	ET	Jamaica	JM	Netherlands Antilles	AN	Senegal	SN
Cambodia	KH	Fiji	FJ	Japan	JP	New Zealand	NZ	Singapore	SG
Canada	CA	Finland	FI	Kenya	KE	Nigeria	NG	Slovak Republic	SK
Chile	CL	France	FR	Kuwait	KW	Norway	NO	Slovenia	SI
China	CN	Germany	DE	Libya	LY	Oman	OM	South Africa	ZA
Colombia	CO	Great Britain	GB	Luxembourg	LU	Pakistan	PK	South Korea	KR
Congo	CG	Greece	GR	Malaysia	MY	Panama	PA	Spain	ES

Troubleshooting

PROBLEM	CAUSE	CORRECTION
No power	The power cord is disconnected.	Plug the power cord into the wall outlet securely.
No picture	The TV is not set to receive the DVD signal.	Select the appropriate video input mode on the TV so the picture from the DVD Receiver appears on the TV screen.
	The video cables are not connected securely.	Connect the video cables securely to both the TV and DVD Receiver.
There is little or no sound	Equipment connected via the audio cable is not set to receive DVD signal output.	Select the correct input mode of the audio receiver so you can hear the sound from the DVD receiver.
	The audio cables are not connected to the speakers or receiver securely.	Connect the audio cables into the connection terminals correctly.
	The audio cables are damaged.	Replace with a new audio cable.
The DVD picture quality is poor	The disc is dirty.	Clean the disc using a soft cloth with outward strokes.
A DVD/CD will not play	No disc is inserted.	Insert a disc
	An unplayable disc is inserted.	Insert a playable disc (check the disc type, colour system and regional code).
	The disc is inserted upside down.	Place the disc with the label or printed side facing upwards.
	The menu is open on screen.	Press SETUP to close the menu screen.
	There is a parental lock which prevents the playback of DVDs with a certain rating.	Enter your password or change the rating level.
Humming noise heard while a DVD or CD is playing	The disc is dirty.	Clean the disc using a soft cloth with outward strokes.
	The DVD receiver is located too close to the TV, causing feedback.	Move DVD receiver and audio components further away from your TV.
Radio stations can't be tuned in properly	The antenna is positioned or connected poorly.	Check the antenna connection and adjust its position. Attach an external aerial if necessary.
	The signal strength of the radio station is too weak.	Tune to the station manually.
	No stations have been preset or preset stations have been cleared (when tuning by scanning preset channels).	Preset some radio stations, see page 18 for details.
The remote control doesn't work well / at all	The remote is not pointed directly at the DVD receiver.	Point the remote directly at the unit.
	The remote is too far from the DVD receiver.	Use the remote within 23 feet (7m) of the DVD receiver.
	There is an obstacle in the path between the remote control and the unit.	Remove the obstacle.
	The batteries in the remote control are flat.	Replace the batteries with new ones.

Types of Playable Discs

Type	Logo
DVD-VIDEO: Discs such as movies that can be purchased or rented.	
DVD-R: Video mode and finalized only	
DVD-RW: Video mode and finalized only DVD VR format that have been finalized can not be played in this unit	
DVD+R: Video mode only Supports the double layer disc also	
DVD+RW: Video mode only	
Video CD (VCD/SVCD):	
Audio CD:	
This unit plays DVD±R/RW and CD-R/RW that contains audio titles, DivX, MP3,WMA and/or JPEG files. Some DVD±RW/DVD±R or CD-RW/CD-R cannot be played on this unit due to the recording quality or physical condition of the disc, or the characteristics of the recording device and authoring software.	

“Dolby”, “Pro Logic”, and the double-D symbol are trademarks of Dolby Laboratories.
Manufactured under license from Dolby Laboratories.

Manufactured under license under U.S. Patent #'s: 5,451,942; 5,956,674; 5,974,380; 5,978,762; 6,487,535 & other U.S. and worldwide patents issued & pending. DTS and DTS Digital Surround are registered trademarks and the DTS logos and Symbol are trademarks of DTS, Inc. © 1996-2007 DTS, Inc. All Rights Reserved.

HDMI, the HDMI logo and High-Definition Multimedia Interface are trademarks or registered trademarks of HDMI licensing LLC.

About the Symbol Display

“” may appear on your TV display during operation and indicates that the function explained in this owner's manual is not available on that specific DVD video disc.

Regional Codes

This unit has a regional code printed on the rear of the unit. This unit can play only DVD discs labeled same as the rear of the unit or “ALL”.

- Most DVD discs have a globe with one or more numbers in it clearly visible on the cover. This number must match your unit's regional code or the disc cannot play.
- If you try to play a DVD with a different regional code from your player, the message “Check Regional Code” appears on the TV screen.

Copyrights

It is forbidden by law to copy, broadcast, show, broadcast via cable, play in public, or rent copyrighted material without permission. This product features the copy protection function developed by Macrovision. Copy protection signals are recorded on some discs. When recording and playing the pictures of these discs picture noise will appear. This product incorporates copyright protection technology that is protected by method claims of certain U.S. patents and other intellectual property rights owned by Macrovision Corporation and other rights owners. Use of this copyright protection technology must be authorized by Macrovision Corporation, and is intended for home and other limited viewing uses only unless otherwise authorized by Macrovision Corporation. Reverse engineering or disassembly is prohibited.

CONSUMERS SHOULD NOTE THAT NOT ALL HIGH DEFINITION TELEVISION SETS ARE FULLY COMPATIBLE WITH THIS PRODUCT AND MAY CAUSE ARTIFACTS TO BE DISPLAYED IN THE PICTURE. IN CASE OF 525 OR 625 PROGRESSIVE SCAN PICTURE PROBLEMS, IT IS RECOMMENDED THAT THE USER SWITCH THE CONNECTION TO THE 'STANDARD DEFINITION' OUTPUT. IF THERE ARE QUESTIONS REGARDING OUR TV SET COMPATIBILITY WITH THIS MODEL 525p AND 625p UNIT, PLEASE CONTACT OUR CUSTOMER SERVICE CENTER.

You have to set the disc format option to [Mastered] in order to make the discs compatible with the LG players when formatting rewritable discs. When setting the option to Live File System, you cannot use it on LG players.
(Mastered/Live File System : Disc format system for Windows Vista)

Specifications

General			
Power supply	Refer to main label.		
Power consumption	Refer to main label.		
Net Weight	4 kg		
External dimensions (W x H x D)	430 x 73 x 305 mm		
Operating conditions Temperature	5°C to 35°C, Operation status: Horizontal		
Operating humidity	5% to 85%		
Laser	Semiconductor laser, wavelength 650 nm		
Tuner FM/AM [MW]			
FM Tuning Range	87.5 - 108.0 MHz or 65.0 - 74.0 MHz, 87.5 - 108.0 MHz		
FM Intermediate Frequency	10.7 MHz		
AM Tuning Range	522 - 1,620 kHz or 520 - 1,720 kHz		
AM Intermediate Frequency	450 kHz		
Amplifier			
Stereo mode	100 W + 100 W (4Ω at 1 kHz, THD 10 %)		
Surround mode Front:	100 W + 100 W (THD 10%) Center*: 100 W		
	Surround*: 100 W + 100 W		
	(4Ω at 1 kHz, THD 10 %)		
	Subwoofer*: 200 W (3Ω at 70 Hz, THD 10 %)		
Speakers			
	Front/Rear Speaker	Center speaker	Passive Subwoofer
Type	2 Way 2 Speaker	2 Way 2 Speaker	1Way1 Speaker
Impedance	4 Ω	4 Ω	3 Ω
Rated Input Power	100 W	100 W	200 W
Max. Input Power	200 W	200 W	400 W
Net Dimensions (W x H x D)	300 x 1277 x 300 mm	430 x 107 x 83 mm	165 x 422 x 415 mm
Net Weight	4.11 kg	1.12 kg	7.6 kg

Designs and specifications are subject to change without prior notice.

Specifications

Transmitter	
External dimensions (WxHxD)	52.8x110.5x140 mm.
Net Weight	0.14 kg
Transmission	2.4 GHz
Power Supply	DC 7.5V max
Wireless Receiver	
Power requirements	Refer to main label
Power consumption	Refer to main label
External dimensions (WxHxD)	64x213.6x252.3 mm
Net Weight	1.2 kg
Reception Output	2.4 GHz