

W1_MCD112-212_ENG_MFL40387022



MODEL : MCD112
MCD212

ENGLISH

There is so much your Hi-Fi system can do

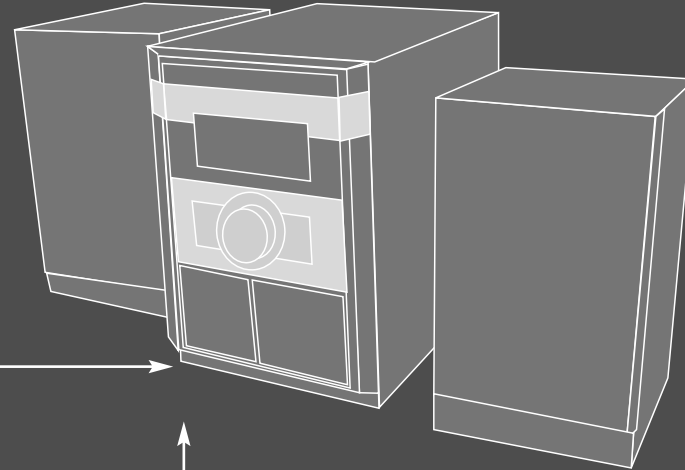

**Record from a CD,
AUX, USB or radio
to cassette**

Go to page 8

Contents

Setting up	3
About Player	4
About Remote control	5
Listening to CDs	6
Connecting your portable USB player - OPTIONAL	6
Listening to the radio	7
Listen to cassette tapes	7
Recording	8
USER EQ	8
Setting the Clock	8
Use your player as an alarm clock	9
About MP3/WMA	9
Safety Precaution	10
Troubleshooting	11
Specifications	11



**Lull me to sleep
and wake me up**

Go to page 9



**Play CDs and
cassettes**

Go to pages 6 & 7

Before connecting, operating or adjusting this product, please read this instruction booklet carefully and completely.

Setting up

1 Connect the speaker cables to the player

Cables from the left-hand speaker connect to the terminal marked L (left) + (plus) and - (minus). Cables from the right-hand speaker are connected to the terminal marked R (right) + (plus) and - (minus). To connect the cable to the player, press each of the four square plastic finger pads on the rear of the player. The connector will open ready to receive a cable.

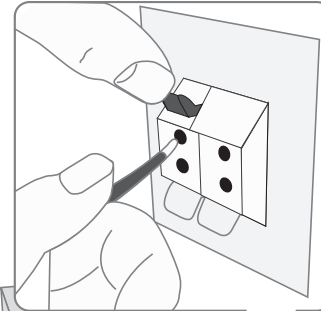

Put the batteries in the remote control

Make sure that the + (plus) and - (minus) on the batteries match those on the remote control.

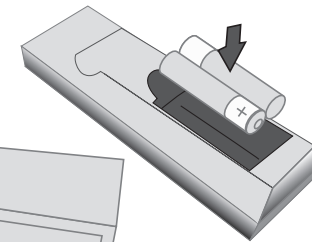

2 Fit the AM loop aerial to its stand

Connect the AM loop aerial to the player.

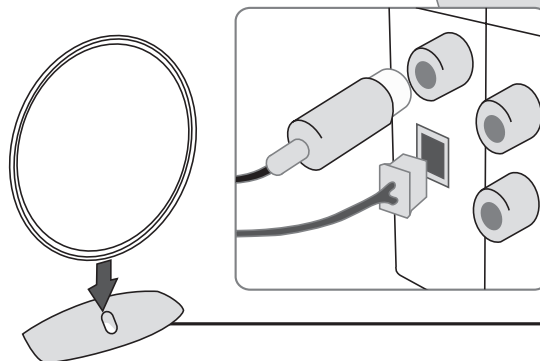



3 Connect the FM aerial

The reception will be at its best when the two loose ends of the aerial are in a straight line and horizontal.

4 Plug the power plug into a wall socket

About Player

POWER

You can set up the unit into an economic power save mode. In the power-on status, press and hold  (POWER) for about 3 seconds. To cancel power save mode, press  (POWER).

ST./MONO

Press **ST./MONO**. This will change the tuner from stereo to mono and usually improve the reception.

MP3 OPT. (MP3 Optimizer)

This function is optimized for compressible MP3 files so that it improves the bass sound.

DEMO

Press **DEMO** in power off state to demonstrate the function on display window. To cancel it, press  or **DEMO** again.

Headphone jack

Connect a headphone plug (ϕ 3.5 mm) into the jack to listen to the sound through headphones (not supplied).

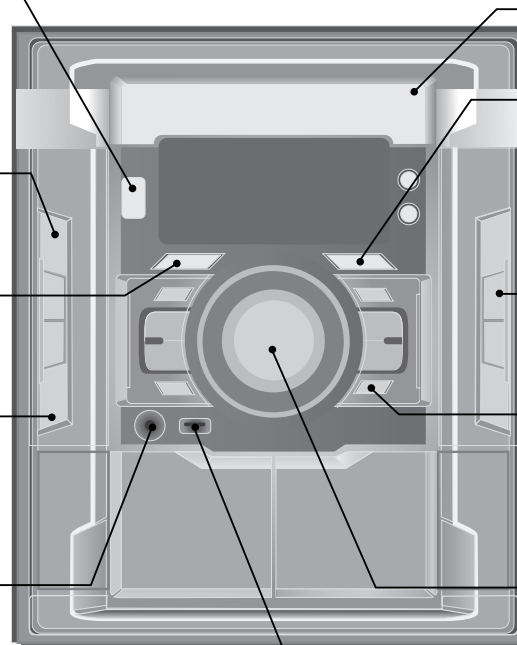

CD tray

XTS - PRO

The function creates the optimum sound for you to play of the original sound. Each time you press **XTS - PRO**, "XTS -- PRO ON" or "XTS -- PRO OFF" is displayed in turn. (The XTS Pro function will not be operated when a headphone has been connected.)

D.SKIP

If more than one portable USB player is connected to the system at the same time, press **D.SKIP** to select one of them.

AUX

You can connect many other types of audio or audio visual device to the system via the auxiliary sockets (AUX IN) on the back of the player.

VOLUME

Control the volume when using any function.

USB connector - OPTIONAL

Connect a remote USB compatible player here.

About Remote control

Search for a folder of MP3/WMA files

When a CD containing MP3/WMA files in several folders is being played, press **PRESET/FOLDER** to select the folder you want to play.

Fall asleep while listening to your player

Firstly, start a radio station or music. Press **SLEEP** on the remote one or more times to select a delay of between 10 and 180 minutes, after which the player will turn off.

Use when playing a CD

Listen to your tracks again and again

Press **REPEAT** once to repeat the track currently playing. Press **REPEAT** twice to repeat the whole CD, or if you're listening to the whole folder of MP3/WMA CD. The display will show what is being repeated.

Use when playing a cassette tape

Sound quality adjustment

You can select a desired sound mode by using **EQ**.

Play any track on a CD

Press the corresponding number buttons on the remote control.

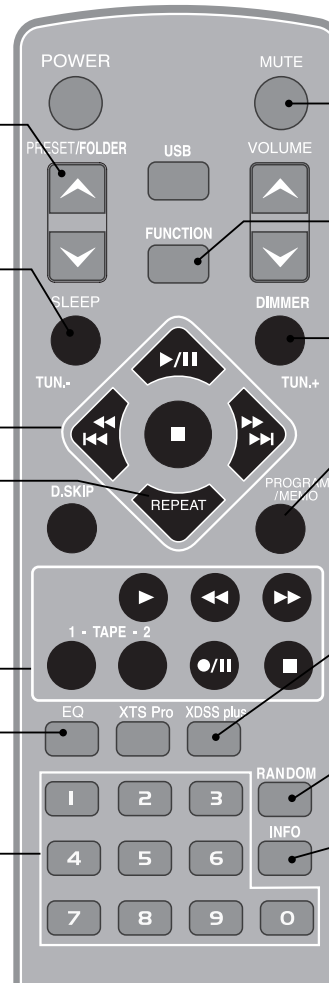

Temporarily stop the sound
Press the button again to return to the sound.

To change the functions
Change the functions between FM, AM, CD, AUX, USB or TAPE.

Dimm the display light

For storing radio stations
If you have saved radio stations using **PROGRAM/MEMO**, you can scroll through them and select one. (see Listening to the radio)

eXtreme Dynamic Sound System
Reinforce the treble, bass and surround sound effect. XDSS ON will show in the display. Press again for XDSS OFF.

RANDOM
Press **RANDOM**, play tracks/files you can in a random order or cancel it.

See information about your music
MP3/WMA files often come with tags. The tag gives the Title, Artist or Album. Press **INFO** while a file is playing to see this information. If there are no tags, "NO ID3 TAG" or "NO WMA TAG" will show.

Listening to CDs

	ON PLAYER	ON REMOTE
1. Open the CD drawer:	▲ OP./CL.	
2. Select the CD tray :	D.SKIP	D.SKIP
3. Insert the CD : Label facing up.		
4. Close the CD drawer: The display will show the total number of tracks (files).	▲ OP./CL.	
5. Select the CD function:	CD	FUNCTION
6. Start the CD playing:	▶	▶/II
7. To stop a CD playing:	■ STOP	■ (CD STOP)

Listening to CDs - more you can do

Pause or restart a CD

Press **CDII** on the front panel or **▶/II** on the remote control during playback. Press this button again to resume play.

Search for a section within a track

Hold **I◀◀◀/▶▶▶I** during playback, then release at the point you want. (This function is only available for Audio CD's.)

Skip to another track

Press **I◀◀◀/▶▶▶I** on either the player or the remote control.

Listen to your tracks in any order

Up to 20 tracks on a CD can be listened to in the order of your choice. Insert a CD and wait for it to be read. Press **PROGRAM/MEMO**, then use **I◀◀◀/▶▶▶I** to select the track. Press **PROGRAM/MEMO** again to save and select the next track. Press **▶** or **▶/II**. To clear your selection, press **STOP**, **PROGRAM/MEMO**, **STOP**.

NOTE : You can choose a desired CD by using **D.SKIP**.

Connecting your portable USB player - OPTIONAL

The advantage of connecting your portable USB player through the system's USB port is that the portable device can be controlled from the system. Connect the portable player to the system using a USB cable (not supplied).

	ON PLAYER	ON REMOTE
1. Press:	USB	USB
2. The display will show CHECKING, followed by the number of files displayed.		
3. Press:	▶	▶/II
4. Alternatively a numbered track can be played by using the numbers on the remote control.		
5. Before disconnecting the portable USB player, change to any other function by pressing:	CD, TUNER, TAPE or AUX	FUNCTION
6. Remove the USB cable.		

NOTE : Some portable devices are not compatible with this system.

Listening to the radio

Make sure both the FM and AM aerials are connected.

	ON PLAYER	ON REMOTE
1. Select either AM or FM:	TUNER	FUNCTION
2. Select the radio station:	TUNING (-) or TUNING (+)	TUN.-/ TUN.+
3. To 'save' a radio station: A preset number will show in the display.		PROGRAM/MEMO
4. To select a 'saved' station: Up to 50 radio stations can be saved.	PRESET(-) or PRESET(+)	PRESET/FOLDER
5. To confirm press:		PROGRAM/MEMO

Listening to the radio - more you can do

See information about your radio stations - OPTIONAL

The FM tuner is supplied with the Radio Data System (RDS) facility. This shows the letters RDS on the display, plus information about the radio station being listened to. Press **RDS** several times to view the information.

PTY - Programme Type, such as News, Sport, Jazz Music.

RT - Radio Text, the name of the radio station.

CT - Time Control, the time at the location of the radio station.

PS - Programme Service name, the name of channel.

You can search the radio stations by programme type by pressing **RDS**.

The display will show the last PTY in use. Press **PRESET(-) / PRESET(+)**

one or more times to select your preferred programme type. Press and

hold **TUNING (-) / TUNING (+)**. The tuner will search automatically. When a station is found the search will stop.

Look for radio stations automatically

Press **TUNING (-) / TUNING (+)** on the front panel for more than 0.5 second. Or press **TUN.- / TUN.+** on the remote control for more than 0.5 second. The tuner will scan automatically and stop when it finds a radio station.

Choose a 'preset number' for a radio station

When storing a radio station, the preset number can be chosen. When the player automatically shows a preset number press **PRESET/FOLDER** then. Press **PROGRAM/MEMO** to save the number.

Delete all the saved stations

Press and hold **PROGRAM/MEMO** for two seconds. "ERASE ALL" shows. Press **PROGRAM/MEMO** to erase all the saved stations.

Listen to cassette tapes

	ON PLAYER	ON REMOTE
1. Open the tape door :		
2. Insert the tape :		
3. Close the tape door :		
4. Select the TAPE function :	TAPE	FUNCTION
5. Start the tape playing :	▶	▶
6. To stop a tape playing:	■ STOP	■ (TAPE STOP)

Listen to cassette tapes - more you can do

To Play Fast backward or Forward

After pressing **◀◀/▶▶** on the remote control or **◀◀◀◀/▶▶▶▶** on the front panel during playback, or stop, press **▶** at a point you want.

Dubbing

This function shows how to record from tape to tape. Press **TAPE** (or **FUNCTION**) to select tape function.

• TAPE 1 - Insert a playback tape to dub.

• TAPE 2 - Insert a blank tape.

Press **DUBB** as shown below. To stop dubbing, press **■**.

Recording

Record from a CD, AUX, USB or radio to cassette

Wind the tape to the point recording starts.

Use only normal tapes.

	ON PLAYER	ON REMOTE
1. Open the TAPE 2 door :	PUSH EJECT	
2. Insert a blank tape :		
3. Close the TAPE 2 door :		
4. Select a mode (FM, AM, CD, USB (OPTIONAL) or AUX) in which you want to record : - Start playing the source you want to record.	CD, TUNER, USB, TAPE or AUX	FUNCTION
5. Puts the unit in standby more for recording:	REC	●/
6. Start the Recording :	REC	●/
7. To stop a Recording :	■ STOP	■

CD to Tape Synchronized Recording

The CD synchro recording function dubs a complete CD and programmed titles automatically into a cassette.

	ON PLAYER	ON REMOTE
1. Select the CD function :	CD	FUNCTION
2. Start the Recording : The synchronized recording is started automatically after about 7 seconds.	CD SYNC.	
3. To stop a Recording :	■ STOP	

USER EQ

You can listen to music with the desired sound effect (BASS, MIDDLE and TREBLE).

	ON PLAYER	ON REMOTE
1. Select a "USER EQ":	EQ.	EQ
2. When "USER EQ" is displayed, press :	SET	
3. Select the sound effect you want among BASS, MIDDLE or TREBLE :	PRESET (-) or PRESET (+)	
4. Adjust sound level (MIN, -4 to +4, MAX) :		
5. Repeat the steps from 3 to 4 to set other sound effect :		
6. Press :	SET	

Setting the Clock

	ON PLAYER
1. Press for at least 2 seconds:	CLOCK
2. Choose from either: AM 12:00 (for an am and pm display) or 0:00 (for a 24 hour display).	
3. Confirm your selection:	SET
4. Select the hours:	
5. Press:	SET
6. Select the minutes:	
7. Press:	SET

Use your player as an alarm clock

Press and hold **TIMER** for two seconds. Each function, TUNER, CD, USB, TAPE flashes for two seconds. Press **SET** when the function you want to be woken by is showing. If you choose TUNER, 'PLAY' and 'REC' flash, PLAY and REC. Choose one of them.

If you choose TUNER and PLAY you will be shown the stations you have saved as presets. Use **TUNING (-)** or **TUNING (+)** to select the station you want, then press **SET**.

You will be shown the ON TIME display. This is where you set the time you want the alarm to go off. Use **TUNING (-)** or **TUNING (+)** to change the hours and minutes and **SET** to save.

You will then be shown the OFF TIME display. This is where you set the time you want the function to stop. Use **TUNING (-)** or **TUNING (+)** to change the hours and minutes and press **SET** to save.

Next you will be shown the volume (VOL) you want to be woken by.

Use **TUNING (-)** or **TUNING (+)** to change the volume and **SET** to save.

Switch the system off. The red (clock icon) shows that the alarm is set.

When the system is turned off you can check the time the alarm is set for by pressing **TIMER**. You can also turn the alarm on and off by pressing **TIMER**. To set the alarm to go off at a different time, switch the system on and reprogramme following the same steps as initially.

About MP3/WMA

MP3/WMA Disc compatibility with this unit is limited as follows:

- Sampling Frequency
8 - 48 kHz (MP3), 32 - 48 kHz (WMA)
- Bit rate
8 - 320 kbps (MP3), 48 - 320 kbps (WMA)
- CD-R physical format should be "ISO 9660"
- If you record MP3/WMA files using the software which cannot create a FILE SYSTEM, for example "Direct-CD" etc., it is impossible to playback MP3 files. We recommend that you use "Easy-CD Creator", which creates an ISO 9660 file system.
- File names should be named using 30 letters or less and must incorporate ".mp3", ".wma" extension e.g. "*****.MP3" or "*****.WMA"
- Do not use special letters such as "/ : * ? " < >" etc.
- Even if the total number of files on the disc has more than 1000, it will only be shown up to 999.

Safety Precaution



CAUTION: TO REDUCE THE RISK OF ELECTRIC SHOCK DO NOT REMOVE COVER (OR BACK) NO USER-SERVICEABLE PARTS INSIDE REFER SERVICING TO QUALIFIED SERVICE PERSONNEL.



This lightning flash with arrowhead symbol within an equilateral triangle is intended to alert the user to the presence of uninsulated dangerous voltage within the product's enclosure that may be of sufficient magnitude to constitute a risk of electric shock to persons.



The exclamation point within an equilateral triangle is intended to alert the user to the presence of important operating and maintenance (servicing) instructions in the literature accompanying the product.

WARNING: TO PREVENT FIRE OR ELECTRIC SHOCK HAZARD, DO NOT EXPOSE THIS PRODUCT TO RAIN OR MOISTURE.

WARNING: Do not install this equipment in a confined space such as a book case or similar unit.

CAUTION: Do not block any ventilation openings. Install in accordance with the manufacturer's instructions.

Slots and openings in the cabinet are provided for ventilation and to ensure reliable operation of the product and to protect it from over heating.

The openings should be never be blocked by placing the product on a bed, sofa, rug or other similar surface. This product should not be placed in a built-in installation such as a bookcase or rack unless proper ventilation is provided or the manufacturer's instruction has been adhered to.

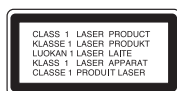

CAUTION:

This product employs a Laser System.

To ensure proper use of this product, please read this owner's manual carefully and retain it for future reference. Should the unit require maintenance, contact an authorized service center.

Use of controls, adjustments or the performance of procedures other than those specified herein may result in hazardous radiation exposure.

To prevent direct exposure to laser beam, do not try to open the enclosure. Visible laser radiation when open. DO NOT STARE INTO BEAM.

CAUTION: The apparatus should not be exposed to water (dripping or splashing) and no objects filled with liquids, such as vases, should be placed on the apparatus.

CAUTION concerning the Power Cord

Most appliances recommend they be placed upon a dedicated circuit;

That is, a single outlet circuit which powers only that appliance and has no additional outlets or branch circuits. Check the specification page of this owner's manual to be certain.

Do not overload wall outlets. Overloaded wall outlets, loose or damaged wall outlets, extension cords, frayed power cords, or damaged or cracked wire insulation are dangerous. Any of these conditions could result in electric shock or fire. Periodically examine the cord of your appliance, and if its appearance indicates damage or deterioration, unplug it, discontinue use of the appliance, and have the cord replaced with an exact replacement part by an authorized servicer.

Protect the power cord from physical or mechanical abuse, such as being twisted, kinked, pinched, closed in a door, or walked upon. Pay particular attention to plugs, wall outlets, and the point where the cord exits the appliance.

To disconnect power from the mains, pull out the mains cord plug. When installing the product, ensure that the plug is easily accessible.



Disposal of your old appliance

1. When this crossed-out wheeled bin symbol is attached to a product it means the product is covered by the European Directive 2002/96/EC.
2. All electrical and electronic products should be disposed of separately from the municipal waste stream via designated collection facilities appointed by the government or the local authorities.
3. The correct disposal of your old appliance will help prevent potential negative consequences for the environment and human health.
4. For more detailed information about disposal of your old appliance, please contact your city office, waste disposal service or the shop where you purchased the product.



This product is manufactured to comply with EMC Directive 2004/108/EC and Low Voltage Directive 2006/95/EC.

European representative :

LG Electronics Service Europe B.V. Veluwezoom 15, 1327 AE Almere,
The Netherlands (Tel : +31-036-547-8940)

Troubleshooting

Symptom	Cause	Correction
No power.	<ul style="list-style-type: none"> The power cord is disconnected. 	<ul style="list-style-type: none"> Plug the power cord into the wall outlet securely.
No sound.	<ul style="list-style-type: none"> The power of the external source equipment is turned off. 	<ul style="list-style-type: none"> Switch on the external source equipment.
	<ul style="list-style-type: none"> The speaker cable is connected to a wrong position. 	<ul style="list-style-type: none"> Set the speaker cable to the correct position, then turn on the unit again by pressing POWER.
The unit does not start playback.	<ul style="list-style-type: none"> An unplayable disc is inserted. 	<ul style="list-style-type: none"> Insert a playable disc.
	<ul style="list-style-type: none"> The disc is placed upside down. 	<ul style="list-style-type: none"> Place the disc with the playback side down.
	<ul style="list-style-type: none"> The disc is not placed within the guide. 	<ul style="list-style-type: none"> Place the disc on the disc tray correctly inside the guide.
	<ul style="list-style-type: none"> The disc is dirty. 	<ul style="list-style-type: none"> Clean the disc.
The remote control does not work properly.	<ul style="list-style-type: none"> The remote control is not pointed at the remote sensor of the unit. 	<ul style="list-style-type: none"> Point the remote control at the remote sensor of the unit.
	<ul style="list-style-type: none"> The remote control is too far from the unit. 	<ul style="list-style-type: none"> Operate the remote control within about 23 ft (7 m).
	<ul style="list-style-type: none"> There is an obstacle in the path of the remote control and the unit. 	<ul style="list-style-type: none"> Remove the obstacle.
	<ul style="list-style-type: none"> The batteries in the remote control are exhausted. 	<ul style="list-style-type: none"> Replace the batteries with new ones.
Unable to record.	<ul style="list-style-type: none"> Record protect tabs are removed. 	<ul style="list-style-type: none"> Cover holes on back edge of tape with tap.

Specifications

General	
Net Weight	5.57 kg (MCD212 Model) 5.36 kg (MCD112 Model)
External dimensions (WxHxD)	270 x 310 x 390 mm
Tuner	
FM Tuning Range	87.5 - 108.0 MHz or 65 - 74 MHz, 87.5 - 108.0 MHz
AM Tuning Range	522 - 1620 kHz or 520 - 1720 kHz
Amplifier	
Output Power	100W + 100 W (MCD212 Model) 50W + 50 W (MCD112 Model)
T.H.D	0.5 %
Frequency Response	40 - 20000 Hz
Signal-to-noise ratio	75 dB
CD	
Frequency response	40 - 20000 Hz
Signal-to-noise ratio	75 dB
Dynamic range	75 dB
Speakers	
MCS212F	Type Bass Reflex 2 Way 2 Speaker
	Impedance 4 Ω
	Rated Input Power 100 W
	Max. Input Power 200 W
	Net Dimensions (WxHxD) 220 x 326 x 272 mm
	Net Weight (1EA) 3.25kg
MCS112F	Type Bass Reflex 2 Way 2 Speaker
	Impedance 4 Ω
	Rated Input Power 50 W
	Max. Input Power 100 W
	Net Dimensions (WxHxD) 200 x 326 x 228 mm
	Net Weight (1EA) 2.92 kg

Designs and specifications are subject to change without notice.



P/NO : MFL40387022