

Model	V-CE641HTG.CAQPLGT		
Language	English+Chinese		
Page	27	Color(cover/body)	1/1
Material	Weight 100g	Size(W*H)	150×220(mm)
Date	2009.02.09	Designer	GEYANG
Part No.	MFL57903810	Description	Owners Manual

### Chage Record

No.	Change content	ECO No.	Date	Designer	Confirm
①					
②					
③					
④					
⑤					
⑥					
⑦					
⑧					
⑨					

## 使用说明书



# 吸尘器

强劲吸力

V-CE641HTG

中文 ——> 1-14 页

English ——> Page15-27

售后服务电话



使用前请仔细阅读说明书，阅读完后请妥善保管以备需要时查阅。

## 目录

产品规格	2
使用前注意事项	3-4
吸尘器的组装与吸力调节	5
部分名称与连接方法	
附件	
尖吸嘴的使用	6
集尘桶的拆卸/清理方法	7
灰尘分离器的清理方法	
集尘桶、灰尘分离器的清理安装方法	8
清洗方法	
安装方法	
电机保护过滤器的拆卸/洗涤/安装方法	9
拆卸方法	
清洗方法	
排气过滤器的拆卸/清洁/安装方法	10
拆卸方法	
清洗方法	
安装方法	
申报故障维修的确认事项	11-13
装相单	14

## 产品规格

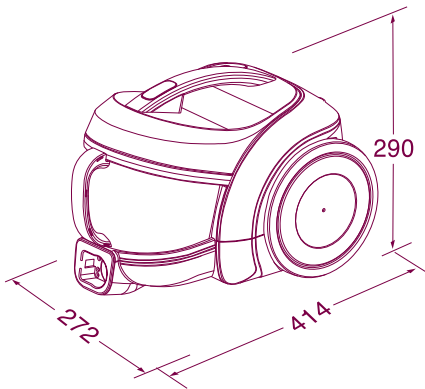

型号: V-CE641HTG  
额定电压: 220V~ 50Hz  
额定功率: 1200W  
最大功率: 1400W  
吸率: 300W  
净重: 5.3Kg  
集尘容量: 1.5L  
外形尺寸: 272mm x 414mm x 290mm  
本产品执行标准: GB4706.1-2005  
GB4706.7-2004  
GB17625.1-2003  
GB4343-2003

※ 为了提高产品质量而进行的外观及设计规格上的变更将不再另行通知。

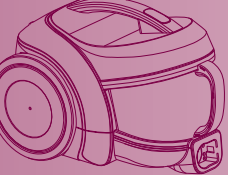

## 使用前注意事项

### 使用前注意事项

忽视说明而导致的错误操作将会对您造成不同程度的损害，请认真阅读以下提示说明。



**危险** 此标识表明违反标记事项时，会立刻发生严重伤害或死亡现象。



**警告** 此标识表明违反标记事项时，有可能发生严重伤害或死亡现象。



**注意** 此标识表明违反此标记事项时，有可能发生财产损失或轻微伤害。



### 危险

请不要在易燃液体附近使用吸尘器，以免发生火灾。

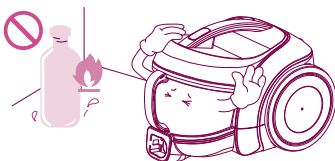

插拔电源插头时，请先关闭电源开关，以免发生火灾或触电的危险。请不要用湿手触摸电源插头，以防触电。（不要在220V以外的电源上使用产品）

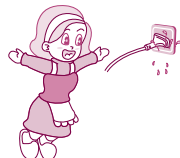

### 警告

请不要让大头钉等金属物存留在软管、机体延长管内，否则会造成短路故障。

请不要吸入头发团、大纸团等物品，否则容易堵塞软管，如有堵管现象，请及时清理。

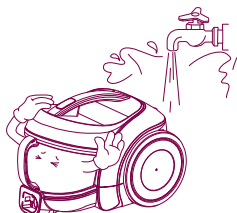
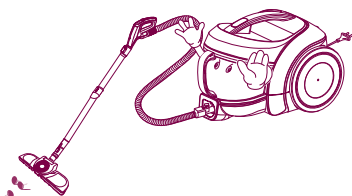

为避免发生火灾或触电的危险，在清扫时，注意不要让机体吸入液体、刀片、火种以及水泥、石膏粉等小微粒。

15A以上的电流请单独使用插线板，在一个插线板上同时使用多种电器可能会引发火灾。建议不要使用电源线延长线，以免引起不必要的危险。本吸尘器最大电流为6A。

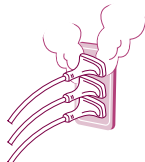



## 使用前注意事项

### 警告

请不要让电源线与吸尘器接近电暖器等热源，以免使机体变形或发生火灾。请您不要使用破损的电源和插头，如有破损，必须由指定维修站更换。



请不要在吸入口和排气口堵塞时，继续长时间运作，否则可能造成机体变形或损坏。

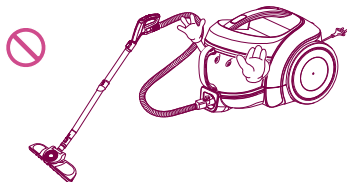

请不要让儿童把吸尘器及组件，如延长管等当做玩具，以防止意外。



使用过程中，延长管和机体会产生静电的可能，请您使用时注意。



### 注意

非专业维修人员请勿开机修理。

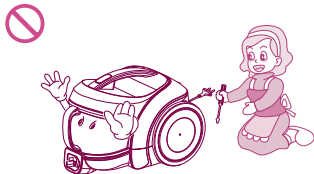

请不要弯曲、践踏、拉拽软管，如软管受损，请不要继续使用。  
请不要用重物或尖刃物压线。



注意不要使电源线夹在门缝里或用电源线提拉吸尘器，防止电源线受损。

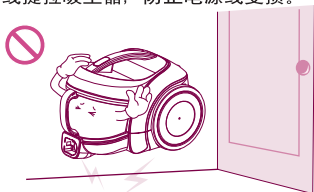

集尘筒集满时，请您正确开启集尘筒清理。请您注意不要在没安装集尘筒或过滤网时使用吸尘器。

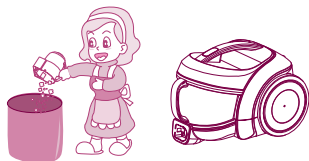

收卷电线时，请拿住电源插头后再按动卷线器按钮。

请不要将电源线拉至红色警告线以外，否则可能损坏电源线或不能回卷。  
收线时请注意插头，以免损坏周围物品。

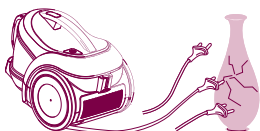

请您注意保护自身安全，使身体各部位远离吸尘器吸口或活动部位。

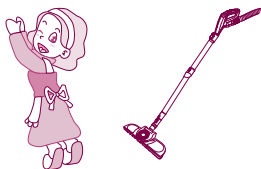

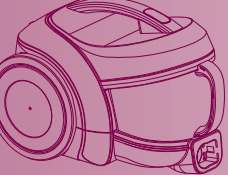

## 吸尘器的组装与吸力调节

### 部分名称与连接方法

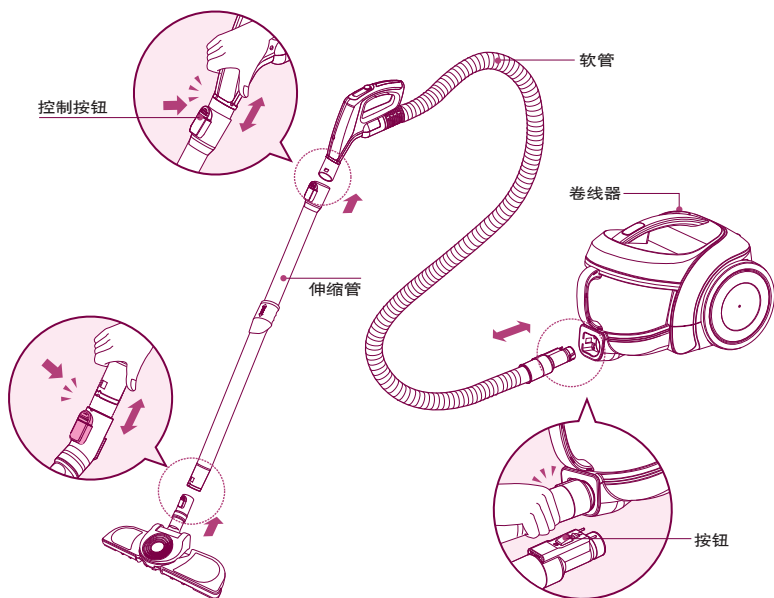
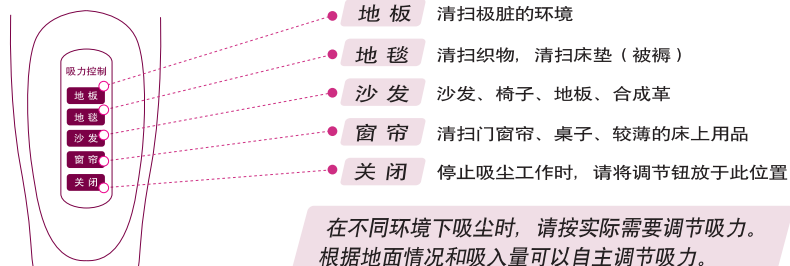

### 附件



● 角落刷头



● 软管

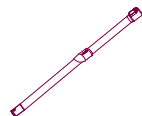

● 伸缩管

## 尖吸嘴的使用

### 尖吸嘴

- ▶ 尖吸嘴可以用来清理房间角落等不易清理到的地方。

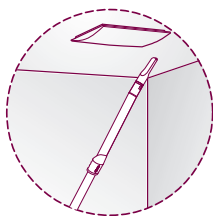
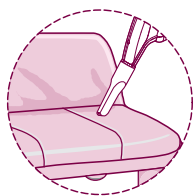
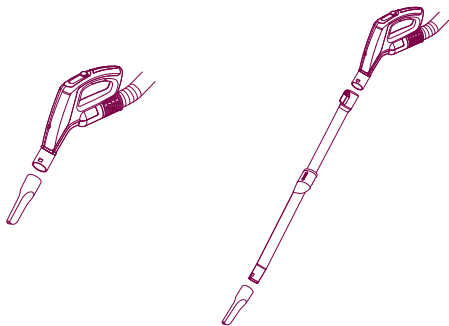
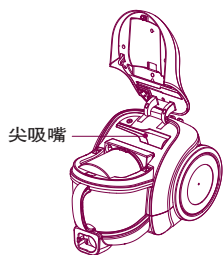

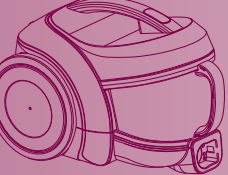

## 集尘桶的拆卸/清理方法

- ⚠ 注意：**
- 集尘量达到集尘桶上标记的MAX线时，清理集尘桶。
  - 集尘量超过MAX时，吸入力可能降低。

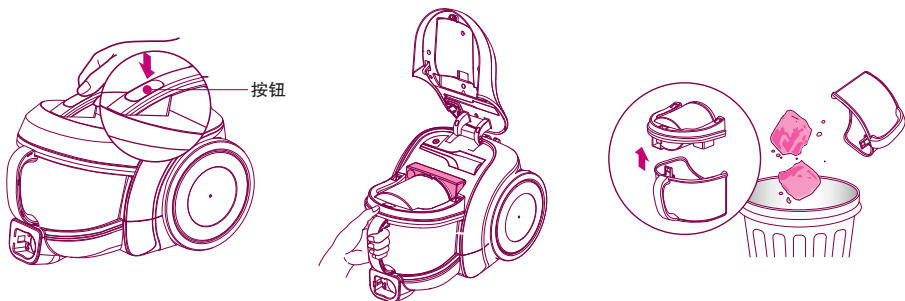

- 1 按住主机盖按钮，打开主机盖。      2 握住集尘桶手柄，取下集尘桶。      3 打开集尘桶的盖子，倒掉灰尘。

## 灰尘分离器的清理方法

- ⚠ 注意：**
- 清洁集尘桶时，检查灰尘分离器内部。
  - 灰尘分离器内部有很多废纸、塑料等异物时，可能降低吸入力，请及时清理灰尘分离器。



- 1 检查灰尘分离器内部是否有灰尘。      2 握住灰尘分离器盖的手柄拆卸盖子。



- 3 倒掉灰尘。      4 堵住灰尘分离器盖的小孔，抖掉灰尘。

# 集尘桶、灰尘分离器的清洗/安装方法

## 清洗方法

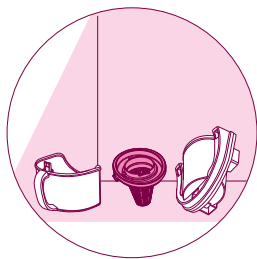
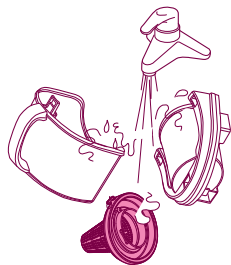

- 冲洗干净集尘桶、灰尘分离器、灰尘分离器盖。
- 在阴凉、通风处干燥一天左右，待完全干燥再使用。

## 安装方法

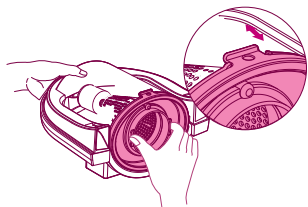

- 1 对准灰尘分离器盖的突起部和灰尘分离器槽后安装盖子。

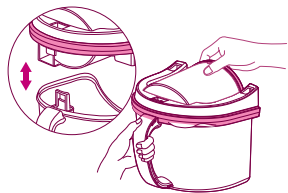

- 2 安装灰尘分离器和集尘桶。

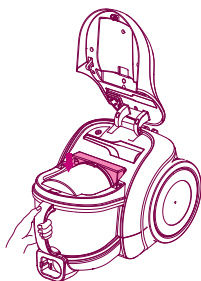

- 3 将集尘桶安装在吸尘器上。

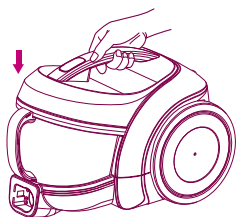

- 4 握住主机移动手柄，盖上吸尘器的盖子。

注意：• 吸尘器盖子没有完全盖好的情况下握住手柄移动吸尘器时，盖子有可能被打开，而导致产品的损坏及集尘桶掉落，所以请务必确认盖子是否盖好，在听到咔的一声响后，证明已经盖好。  
• 在没有安装灰尘分离器盖的情况下使用吸尘器时，有可能出现噪音变大、吸入力急剧降低的现象，所以请务必再次确认是否安装好。

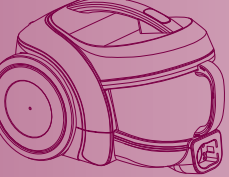

# 电机保护过滤器的拆卸/洗涤/安装方法

## 拆卸方法

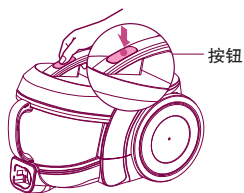

1 按住主机盖按钮，打开主机盖。

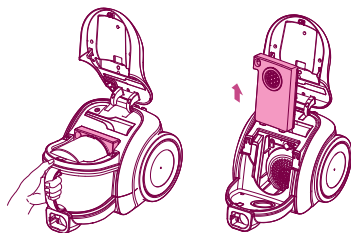

2 拆卸集尘桶后，从主机取出电机保护过滤器。

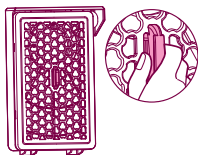

3 握住过滤器外壳手柄，从过滤器盖分离。

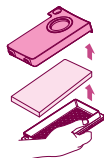

4 取出电机保护过滤器。

## 清洗方法

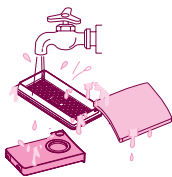

1 冲洗干净



2 彻底去除水分

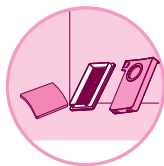

3 在阴凉、通风处干燥一天左右，待完全干燥后再使用。

注意：• 安装方法与拆卸方法相反。

• 在没有安装电机保护过滤器的情况下使用吸尘器时，可能出现噪音变大、灰尘进入电机，导致产品寿命缩短等现象，所以请再次确认安装情况。

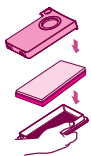

1 将电机保护过滤器装入过滤器外壳内。

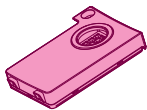

2 盖上过滤器盖。

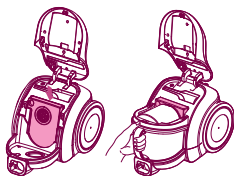

3 将组装好的过滤器插入过滤器安装部位后安装集尘桶。

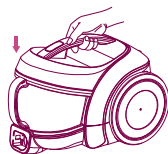

4 握住主机的移动手柄，盖上吸尘器盖。

# 集尘桶、灰尘分离器的清洗/安装方法

## 拆卸方法

- ▶ 排气过滤器至少半年清洗一次或根据使用频率酌情清理。

排气过滤器盖按钮

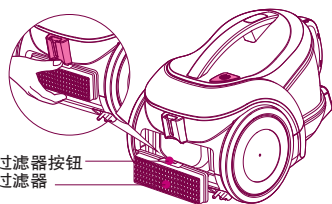
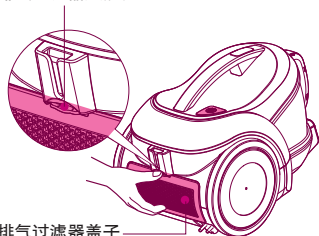

## 清洁方法



- 1 抖动排气过滤器进行清洁。

## 安装方法

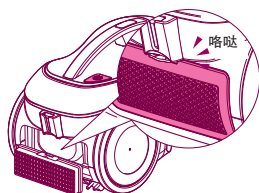

- 2 放入排气过滤器，按钮处有“咯哒”声时，表示排气过滤器盖安装准确。

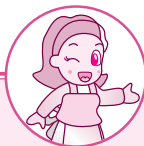

## 使用吸尘器后的保管方法

卷线器按钮

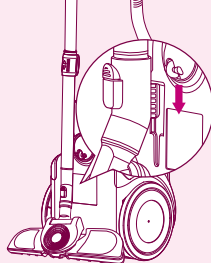
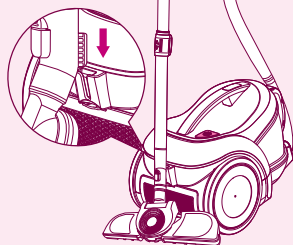
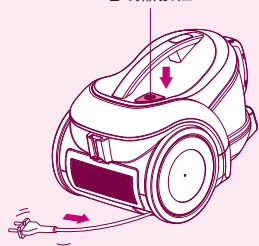

- 按下卷线器按钮时吸尘器电线自动被卷入。
- 吸入口的突起部插入主机背面或底面的凹槽后进行保管。

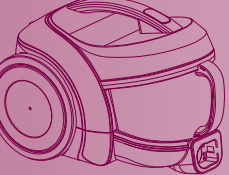

## 申报故障维修前的确认事项

- ▶ 我们应该避免产品并没有出现故障，却因申请维修服务而带来的不必要的麻烦。产品出现异常时，在申请服务中心或代理店的服务之前请确认以下事项。或许按照使用说明书的简单操作就可以解决了。

吸入力差？

**第一阶段** 确认吸入力调节键是否设为“最强”。

**第二阶段** 清洗电机保护过滤器。

12p

### 拆卸方法

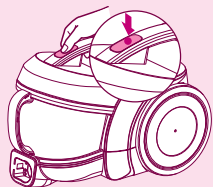

**1** 按住主机盖按钮，打开主体盖。

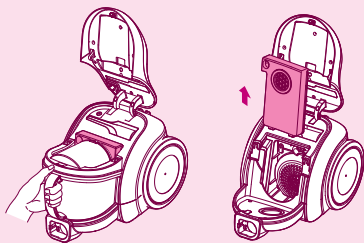

**2** 卸下集尘桶，从主机取出电机保护过滤器。

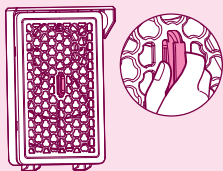

**3** 握住过滤器外壳手柄，从过滤器盖分离。

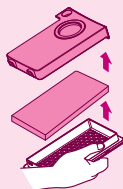

**4** 取出电机保护过滤器。

### 清洗方法 (用凉水清洗)



**1** 用流动水冲洗干净



**2** 彻底去除水分。

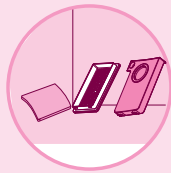

**3** 在阴凉、通风处干燥一天左右，待完全干燥后再使用。



# 故障通告前需确认事项

## 故障通告前请先确认

- ▶ 如果您怀疑产品发生故障，请先确认故障发生原因，再与售后服务中心或代理商联系，以确保检修的效率。

现象:

噪音加大  
软管收缩

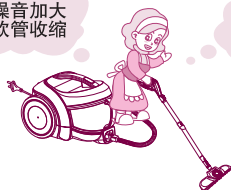

吸力忽然  
下降

吸尘器求助:

请检查集尘筒  
和吸入口



## 处理要领

- ① 查看集尘筒灰尘是否集满（到达MAX处），如果是，请及时清理集尘筒。



已经满了吗？请及时清理集尘筒哦！

- ② 请确认集尘筒滤芯是否堵塞  
过滤器堵塞时会发出异常声，请及时清洗。



滤芯有问题吗？那么检查一下吸入口。

- ③ 检查吸入口时，需将吸力调节到最大。

### 第一步

将伸缩管与刷头分离后，检查有无阻塞，如发现问题请立即清理。



如果还有问题，请进行第二步。

### 第二步

分离手柄与伸缩管，检查有无阻塞，如有阻塞，请将伸缩管收短，清除异物。



如果还有问题，请进行第三步。

### 第三步

检查软管是否阻塞，将吸力调至最强，用手堵放管口，反复几次。



如果还有问题，请清理一下滤芯。



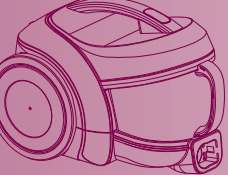

## 故障通告前需确认事项

### 故障通告前请先确认

- ▶ 如果您怀疑产品发生故障，请先确认故障发生原因，再与售后服务中心或代理商联系，以确保检修的效率。

#### 故障

吸尘器为何不能工作？



机体内有噪音。



机体出现异味。



电源线不能全部卷入机体，电源线不能全部拉出。



机体或排出的气体过热。



软管内壁脏。

#### 检查

- 电源插头是否插上？
- 电源插座有电吗？
- 软管是否插上？
- 电机热保护处于开启期间。

- 吸尘器吸力过大或电机高速运转时所发出的声音，不属于异常情况，请正常使用。
- 如果不是正常的电机响声，而是异常的噪音，请打电话与维修中心联系。
- 集尘筒已满。
- 集尘筒滤芯堵塞。
- 吸入口阻塞。
- 伸缩管阻塞。
- 软管阻塞。

- 电机运作时，用于固定电机的橡胶圈会受热而产生少量气味，不会影响运作或使机器发生损坏。
- 机器不小心吸入一些水或集尘筒长期不清理时，会有一些异味排出，此时应及时清理集尘筒。

- 将电源线拉出一部分后重新卷入。
- 请用力将电源线拉出，不会损坏电源线。
- 由于线在内部互相缠绕或夏季周围温度过高所致。
- 由于线在内部折曲或未缠在卷线器上，启动卷线器后，能正常运作。

- 吸力是否正常？

- 从机体内排出的热气，是由电机导热产生的热量所致，属正常温度，请继续使用。

- 请勿将水吸入，水与灰尘混合吸入后，有可能弄脏管壁。

#### 措施

- 请将电源插牢（本产品适用于220V电压）。
- 确认插座是否有电。
- 将软管插牢。
- 2小时后重新启动。

- 清理集尘筒。
- 用软毛刷轻刷滤芯，用水冲洗后放置于阴凉处风干一天。
- 将吸入的异物取出后再使用。
- 将伸缩管内异物取出后再使用。
- 将软管内异物取出后再使用。

# 装箱单

## 装箱单

吸尘器 .....	一台
说明书 .....	一本
软管 .....	一根
伸缩管 .....	一根
角落刷头 .....	一个

## Table of contents

<i>Product specifications</i> .....	15
<i>Attention before using the appliance</i> .....	16~17
<i>Assembling and adjusting the Cleaner</i> .....	18
<i>Parts description and assembly</i>	
<i>Accessories</i>	
<i>Elbow Tube</i> .....	19
<i>How to separate or empty the dust box</i> .....	20
<i>How to empty the dust separator</i>	
<i>How to clean and assemble the dust box and separator</i> .....	21
<i>Cleaning</i>	
<i>Assembling</i>	
<i>How to separate, clean and assemble the protection filter of the motor</i> .....	22
<i>Disassembling</i>	
<i>Cleansing</i>	
<i>How to separate, clean and assemble exhaust filter</i> .....	23
<i>Disassembling</i>	
<i>Cleansing</i>	
<i>Assembling</i>	
<i>Check before reporting the trouble</i> .....	24~26
<i>Packing List</i> .....	27

## Product specifications

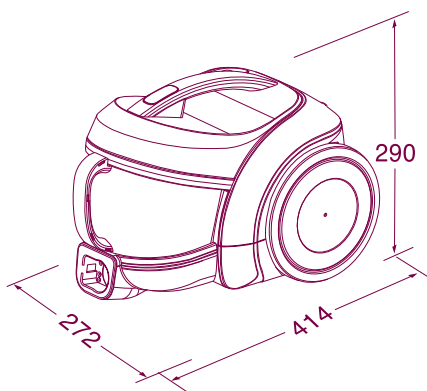

Model: V-CE641HTG

220V~ 50Hz

IEC: 1200W

MAX: 1400W

Suction Power: 300W

Net Weight: 5.3Kg

Dust Capacity: 1.5L

Dimension: 272mm x 414mm x 290mm

This appliance complies with the following GB Directives:

GB4706.1-2005

GB4706.7-2004

GB17625.1-2003

GB4343-2003

※ You will not be informed otherwise of any changes in appearance and standard deriving for improvement of product quality.

# Attention before using the appliance

## Attention before using the appliance

Please read all the following information, which contains important instructions for the safety, the use of the appliance.



### DANGER

May immediately cause serious injury or death.



### WARNING

May possibly cause serious injury or death.



### ATTENTION

May possibly cause losses of property or light injury.



### DANGER

Do not pick up anything that is burning or smoking, such as cigarettes, matches or hot ashes.



Please turn off the power before pulling out the plug to prevent fire or electric shock. Never handle plug or appliance with wet hands. (Do not use the appliance on the power above 220V.)

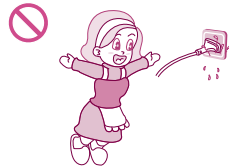

### WARNING

Avoid picking up hard, sharp objects with the cleaner. They may damage the cleaner and the tank.

Do not vacuum the objects like hair ball or big paper ball, otherwise the hose is possibly blocked up. Please clear the hose in time when it is blocked.

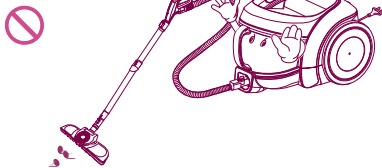

To avoid the danger of fire or electric shock, do not vacuum liquid, blade, flammable substances, or small particles like cement and gesso in cleaning.

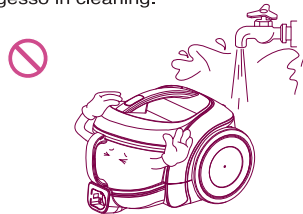

Independently use a socket when the current is  $\geq 15A$ . It may cause fire when many electric appliances share one socket. In order to avoid the needless danger, you had better not use the prolonged thread of power cord. The current at most 6A is allowed



Unplug cleaner when not in use. Turn off all controls before unplugging.



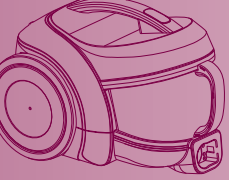

# Attention before using the appliance

## ! WARNING

Do not let the power cord near the electric heater or other heat source, lest that the cleaner should be deformed or it should cause fire. Do not use the appliance when the power cord or plug is damaged. The damaged power cord or plug must be replaced in the approved service station.



Close supervision is necessary when any appliance is used by or near children. Do not allow vacuum cleaner to be used as a toy or to run unattended at any time.

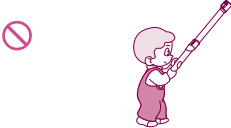

Do not operate the appliance for long when the nozzle inlet or nozzle outlet is blocked, which may have it deformed or damaged.

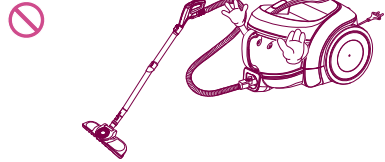

In using the appliance, pay attention to the electrostatic effect generated on the telescopic tube and cleaner body.

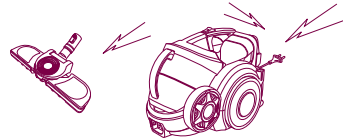

## ! ATTENTION

Do not allow the non-professional maintenance people to repair.

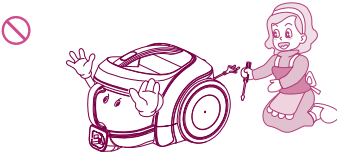

Do not pull or carry by cord, use cord as a handle, close door on cord or pull cord around sharp edges or corners. Do not run appliance over cord. Keep cord away from heated surfaces.

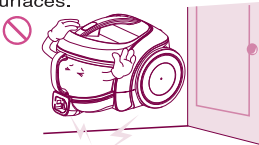

In winding the power cord, hold the plug before pressing the button of the cord reel. Do not pull the power cord beyond the red warning line, other wise the power cord may be damaged or unable to be wound up. Pay attention to the plug in winding the cord to avoid damaging the surrounding objects.

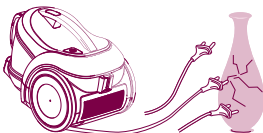

Do not bend, stamp on, or drag the hose. Do not continue to use the hose if it is damaged.

Do not use any heavy or sharp object to press the power cord.



Do not use without dust tank or filters in place. Change tank frequently when picking up very fine materials such as powder.

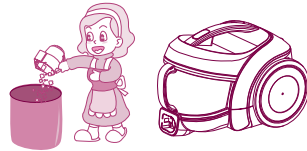

Keep hair, loose clothing, fingers, feet and all parts of body away from the nozzle or movable portion.

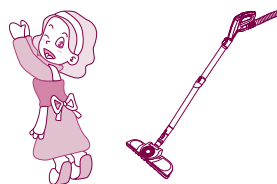

# Assembling and adjusting the Cleaner

## Parts description and assembly

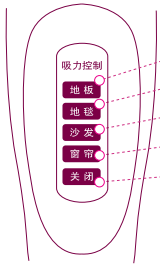

- **地板** cleaning the dirtiest environment.
- **地毯** cleaning fabrics and mattress (bedding).
- **沙发** cleaning sofa, chair, floor.
- **窗帘** cleaning door and window curtain, table, and light blanket.
- **关闭** Adjusting to “关闭” when you stop operating the appliance.

When cleaning under different environment, adjust the suction level according to practical need.

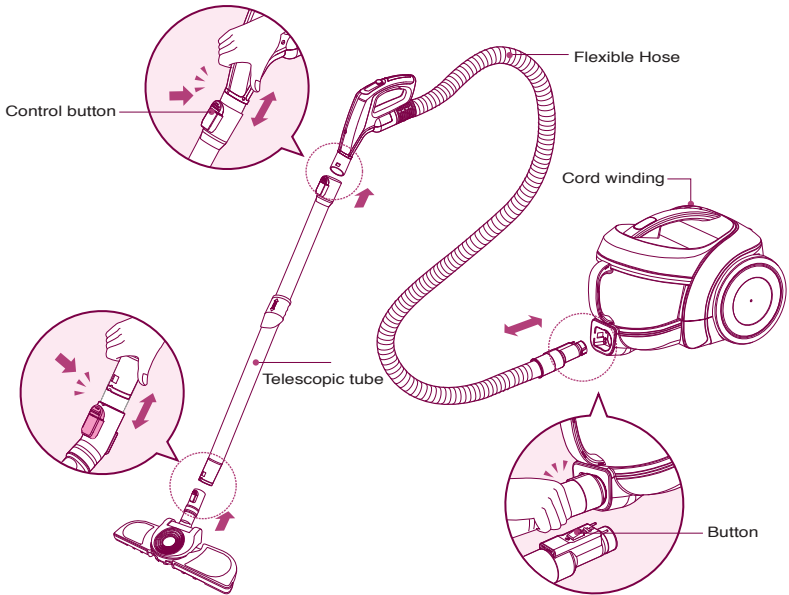

### Accessories



● Corner Nozzle



● Hose

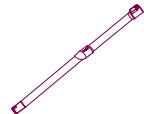

● Telescopic tube

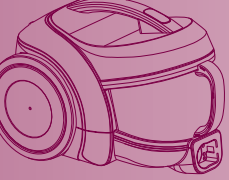

## Using the Accessories, Elbow Tube

### Nozzle, Crevice

- ▶ Nozzle, Crevice can be used for cleaning the place hard to reach.

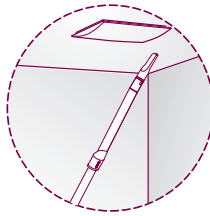
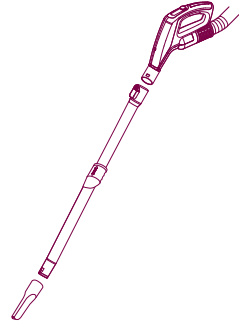
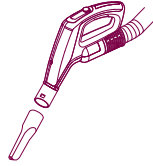



# How to separate or empty the dust box

- Warning:**
- Empty the box when the dust settles up to the MAX line.
  - Too much dust beyond this line may reduce the inhaling power.

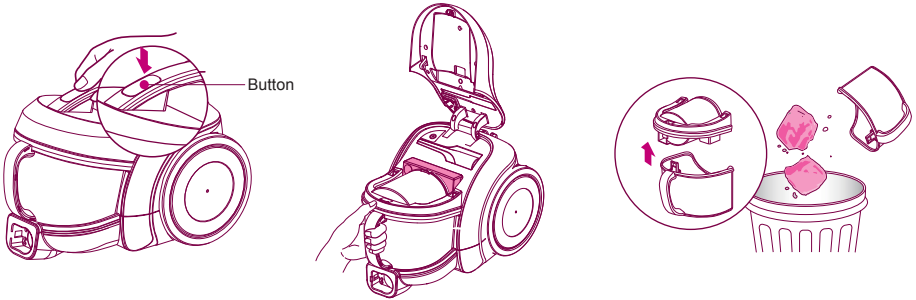

- 1 Uncover by pressing the button.
- 2 Detach the dust box by holding its handle.
- 3 Empty the dust box.

## How to empty the dust separator

- Warning:**
- Check the inside of the dust separator when cleaning the dust box.
  - Clean the inside of the dust separator, because too much foreign substance such as waste paper or plastic in the dust separator may reduce the inhaling power.



- 1 Check if the dust has settled in the dust separator.
- 2 Separate the cover by holding its handle.

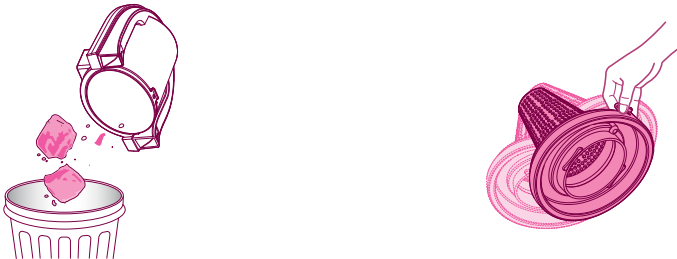

- 3 Empty the separator.
- 4 Remove the dust from the small holes in the cover of the separator.

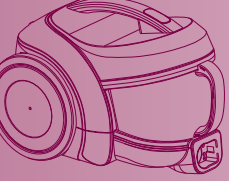

# How to clean and assemble the dust box and separator

## Cleaning



- Cleanse the dust box, separator and its cover with running water.

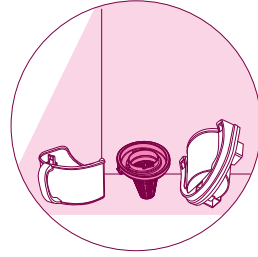

- Dry them in the well-ventilated shade for a day before using.

## Assembling

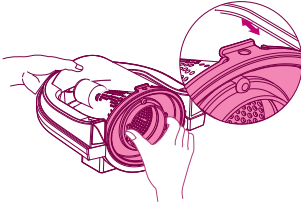

- 1 Attach the cover by inserting the spiral in the cover into the groove.

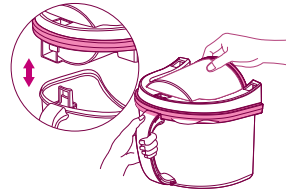

- 2 Assemble the dust separator and box.

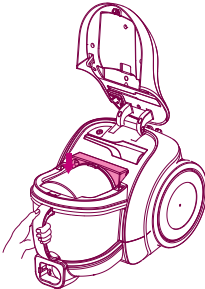

- 3 Attach the assembled dust box to the body of the cleaner.

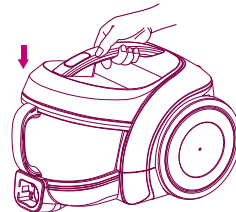

- 2 Cover the cleaner by holding the carrying handle of the body.

**Warning:**

- If you move the cleaner by holding the carrying handle with the cover not fully closed, the cover may open, causing damage to the parts and the dust box. So check if the cover has been properly closed.
- If you use the cleaner without assembling the cover of the dust separator, it will increase the noise and reduce the inhaling power when cleaning. So check the assembling once again.

# How to separate, clean and assemble the protection filter of the motor

## Disassembling

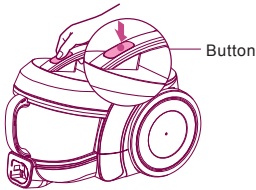

- 1 Uncover by pressing the button.

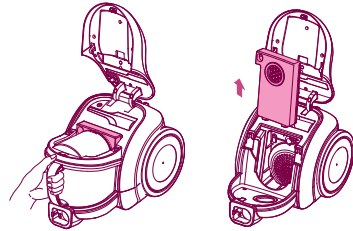

- 2 Detach the protection filter of the motor from the body after disassembling the dust box.

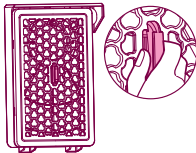

- 3 Separate it from the filter cover by holding the handle of the case.

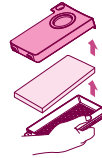

- 4 Detach the filter.

## Cleansing



- 1 Clean with running water.



- 2 Remove the water completely.

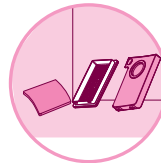

- 3 Dry in the well-ventilated shade for a day before using.

**Warning:** • Assembling is done in reverse order of disassembling.

• If you use the cleaner without assembling the protection filter of the motor, noise increases and dust gets into the motor when cleaning, thus leading to the shorter life of the cleaner. So check the assembling once again.



- 1 Put the filter into the case.



- 2 Cover the filter.

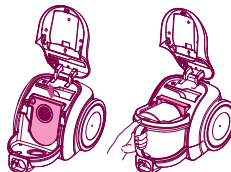

- 3 Mount the assembled filter and assemble the dust box.

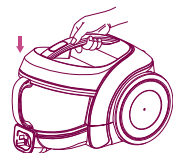

- 4 Cover the cleaner by holding the carrying handle of the body.

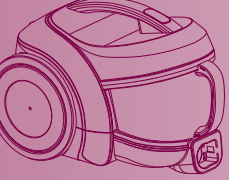

# How to separate, clean and assemble exhaust filter

## Disassembling

- ▶ The exhaust filter should be cleaned at least once half a year. Allow exhaust filter to dry in a shaded location for a dry.

Cover button of the exhaust filter

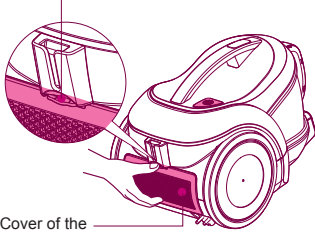

Cover of the exhaust filter

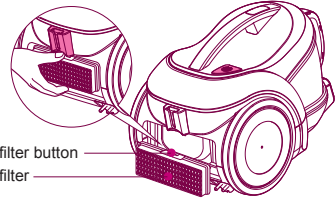

Exhaust filter button  
Exhaust filter

## Cleansing

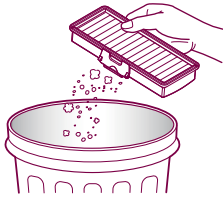

- 1 Shake off the exhaust filter.

## Assembling

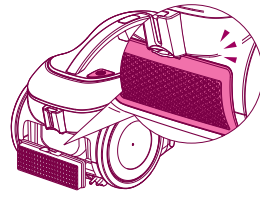

- 2 Insert the exhaust filter and join the cover properly until you hear the click of the button.



## How to keep the cleaner after using

Cord winding button

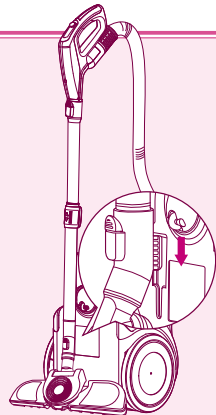
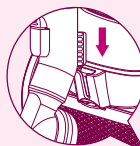
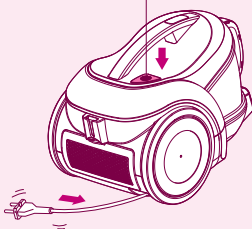

- The cord winds up when you press the button.
- Insert the spiral of the inhaler into the groove in the back or at the bottom of the body.

# Check before reporting the trouble

- ▶ You won't be happy to waste money by calling for service when there is no trouble with the cleaner. Here is good advice to follow for trouble shooting before calling for service. Read the instructions carefully, and you can remove the trouble by yourself.

If inhaling is not well done?

Stage 1

Check if the control button of the inhaling power has been put to "MAX".

Stage 2

Clean the protection filter of the motor.

12p

## Disassembling

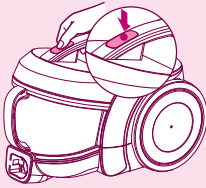

- 1 Uncover the body by pressing the button of the cover.

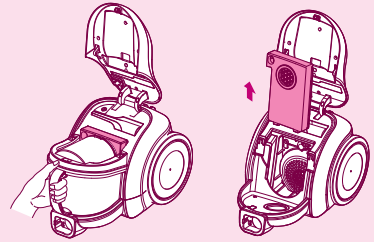

- 2 Detach the protection filter of the motor from the body after disassembling the dust box.

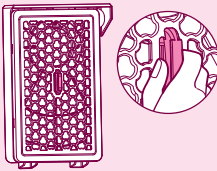

- 3 Separate the filter from the cover by holding the handle of the case.

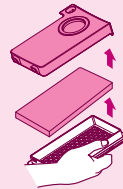

- 4 Detach the protection filter of the motor.

## Cleansing (with cold water)



- 1 Cleanse it with running water.



- 2 Remove the water completely.

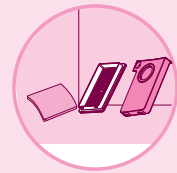

- 3 Dry it in the well-ventilated shade for a day before using.

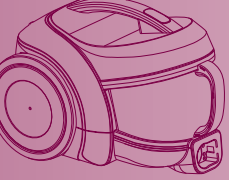

# If you have a problem

## If you have a problem

- If a minor problem occurs, it usually can be solved quite easily when the cause is found by using the check list below.

Problem:

The noise increases and the hose shrink.



Suction power is abruptly weakened.

Help:

Check the dust tank and suction inlet.



## Solution

- 1 Dust tank full. (Arrive at MAX line)  
Empty dust tank.



Is it full? Empty the dust tank in time!

- 2 Motor filter dirty.  
Clean the motor filter with brush and water, allow to dry and replace in cleaner.



Is the filter OK? Then check the suction inlet.

- 3 When checking the suction inlet, adjust the suction level to the maximum.

### First step

Turn cleaner off and disconnect from electrical outlet, then disconnect nozzle from telescopic tube. Check if it is blocked, and remove any blockages.



If there is still a problem, proceed the second step.



### Second step

Disconnect the telescopic tube from hose. Check if it is blocked, and remove any blockages.



If there is still a problem, proceed the third step.

### Third step

Plug cleaner in, turn on, and check hose end for suction. Remove any obstructions.







If there is also a problem, clean the filter.



# If you have a problem

## Please check before notifying malfunction

► If you doubt the product meets with malfunction, please check the cause of such malfunction before contacting with the after-sales service center or agent, so as to ensure efficiency of repair.

Malfunction	Check	Troubleshooting
<p>The vacuum does not work?</p> 	<ul style="list-style-type: none"><li>• Is the plug inserted?</li><li>• Is the socket powered on?</li><li>• If the hose inserted?</li><li>• If the motor heat protection opened?</li></ul>	<ul style="list-style-type: none"><li>• Insert the plug tight (This product is applicable for 220V)</li><li>• Verify the power of socket is on</li><li>• Insert the hose tight</li><li>• Restart in 2 hours</li></ul>
<p>The vacuum does not work?</p> 	<ul style="list-style-type: none"><li>• When the vacuum cleaner's suction is too large or the motor is under high speed running, they do not belong to the abnormal conditions. So, please use the vacuum cleaner properly.</li><li>• If it is the noise rather than the normal motor sound, please phone the repair center.</li><li>• The duster collector is filled up.</li><li>• The filter is clogged.</li><li>• Suction inlet is jammed.</li><li>• Drawtube is clogged.</li><li>• Hose is clogged.</li></ul>	<ul style="list-style-type: none"><li>• Clean out the dust collector.</li><li>• Purge the sponge filter with water and air-dry in the shady and cool place for one day.</li><li>• Take out the sucked objects before use.</li><li>• Take out the objects inside the drawtube before use.</li><li>• Take out the objects inside the hose before use.</li></ul>
<p>Peculiar smell exists inside the vacuum cleaner</p> 	<ul style="list-style-type: none"><li>• When the motor is running, the rubber band used for fixing the motor will produce a little smell due to the heat, but it will not affect the operation or damage the machine.</li><li>• When the machine sucks some water accidentally or the dust collector is not cleaned for a long period of time, the peculiar smell will be produced. So, clean up the dust collector timely.</li></ul>	
<p>The power cord can not be scrolled thoroughly into the vacuum cleaner or the power cord can not be fully pulled.</p> 	<ul style="list-style-type: none"><li>• Pull out part of the power cord and then re-scroll it.</li><li>• Please put forth your strength to pull out the power cord, which will not be damaged.</li><li>• The power cord entwined inside the machine or it is caused by high temperature in the summer.</li><li>• The cord is bended inside the machine or not coiled around the winder. After the winder is started, the normal operation could be realized.</li></ul>	
<p>The vacuum cleaner or the discharged air is too heat.</p> 	<ul style="list-style-type: none"><li>• Is the suction normal?</li></ul>	<ul style="list-style-type: none"><li>• The heat air discharged from the machine is arising from the heat produced by motor. So, the temperature is normal, please use the machine continuously.</li></ul>
<p>Inner wall of the hose is too dirt.</p>	<ul style="list-style-type: none"><li>• Never suck the water because after mixing of the water and dust, the tube wall will be polluted and the motor will be damaged.</li></ul>	

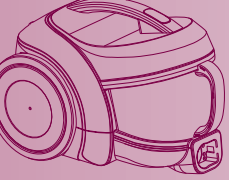

## Packing List

### Packing List

Vacuum Cleaner .....	1
Owner's Manual .....	1
Hose .....	1
Telescopic tube .....	1
Conner Nozzle .....	1



如有问题

瞬间感动 Moment Of Truth  
LG 售后

请打电话



400-819-9999

售后热线



LG 电子 (天津) 电器有限公司

地址: 中国·天津市北辰区兴淀公路

传真: 022-26903476

邮编: 300402

全国技术服务中心服务咨询电话: 400-819-9999



<http://cn.lge.com>

P/No.: MFL57903810