

使用说明书

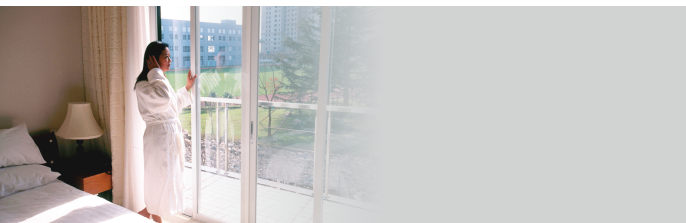

吸尘器

强劲吸力

V-774CAY

中文 → 1-12页

English → Page 13-23

售后服务电话



使用前请仔细阅读说明书，阅读完后请妥善保管以备需要时查阅。

目 录

产品规格	2
使用前注意事项	3-4
吸尘器的组装与吸力调节	5
部分名称与连接方法	
附件	
各种附件刷头的使用方法	6
毛刷、尖吸嘴、鸭嘴的使用	
可折叠刷头的使用	
震动刷头使用方法与清洗方法	7
使用方法	
清洗方法	
集尘筒	8
取放方法	
清洗方法	
排气海绵的清洗更换	9
排气海绵	
机器的正确保管	9
故障通告前需确认事项	10-11
装箱单	12

产品规格

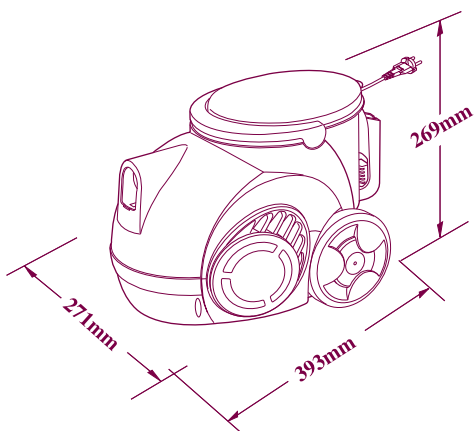

型号: V-774CAY
额定电压: 220V~50Hz
额定功率: 1200W
最大功率: 1400W
吸率: 300W
净重: 4.5KG
集尘容量: 1L
外形尺寸: 393mmx271mmx269mm
本产品执行标准: GB4706.1-2005
GB4706.7-2004
GB17625.1-2003
GB4343-2003

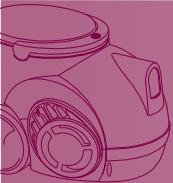

※ 为了提高产品质量而进行的外观及设计规格上的变更将不再另行通知。



使用前注意事项

使用前注意事项

忽视说明而导致的错误操作将会对您造成不同程度的损害，请认真阅读以下提示说明。

-  **危险** 此标识表明违反标记事项时，会立刻发生严重伤害或死亡现象。
-  **警告** 此标识表明违反标记事项时，有可能发生严重伤害或死亡现象。
-  **注意** 此标识表明违反此标记事项时，有可能发生财产损失或轻微伤害。

危险

请不要在易燃液体附近使用吸尘器，以免发生火灾。

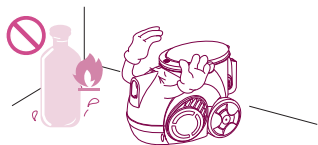

插拔电源插头时，请先关闭电源开关，以免发生火灾或触电的危险。请不要用湿手触摸电源插头，以防触电。（不要在220V以外的电源上使用产品）



警告

请不要让大头钉等金属物存留在软管、机体延长管内，否则会造成短路故障。请不要吸入头发团、大纸团等物品，否则容易堵塞软管，如有堵管现象，请及时清理。

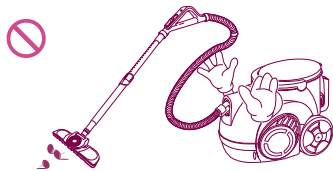

为避免发生火灾或触电的危险，在清扫时，注意不要让机体吸入液体、刀片、火种以及水泥、石膏粉等小微粒。



15A以上的电流请单独使用插线板，在一个插线板上同时使用多种电器可能会引发火灾。建议不要使用电源线延长线，以免引起不必要的危险。本吸尘器最大额定电流为6A。

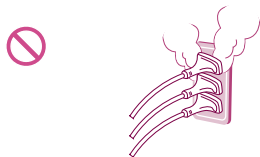

长时间不使用电器时，请记住拔掉电源插头；正处于通电时，请您不要离开。



使用前注意事项

警告

请不要让电源线与吸尘器接近电暖器等热源，以免使机体变形或发生火灾。请您不要使用破损的电源和插头，如有破损，必须由指定维修站更换。



请不要在吸入口和排气口堵塞时，继续长时间运作，否则可能造成机体变形或损坏。

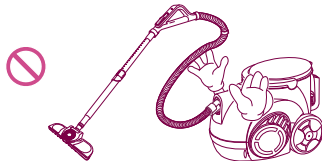

请不要让儿童把吸尘器及组件，如延长管等当做玩具，以防止意外。



使用过程中，延长管和机体会产生静电的可能，请您使用时注意。

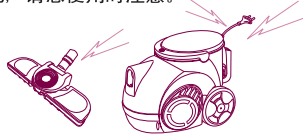

注意

非专业维修人员请勿开机修理。



请不要弯曲、践踏、拉拽软管，如软管受损，请不要继续使用。
请不要用重物或尖刃物压线。



注意不要使电源线夹在门缝里或用电源线提拉吸尘器，防止电源线受损。

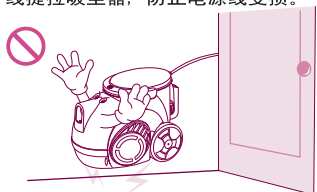

集尘筒集满时，请您正确开启集尘筒清理。请您注意不要在没安装集尘筒或过滤网时使用吸尘器。

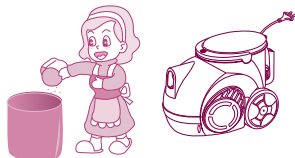

收卷电线时，请拿住电源插头后再按动卷线器按钮。

请不要将电源线拉至红色警告线以外，否则可能损坏电源线或不能回卷。

收线时请注意插头，以免损坏周围物品。

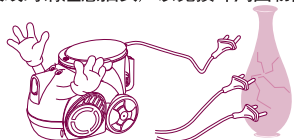

请您注意保护自身安全，使身体各部位远离吸尘器吸口或活动部位。



吸尘器的组装与吸力调节

吸尘器的组装

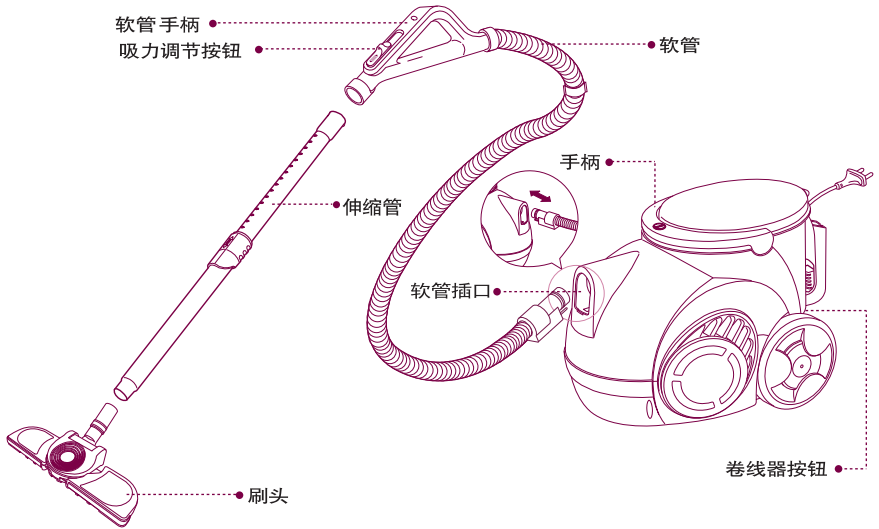

附件

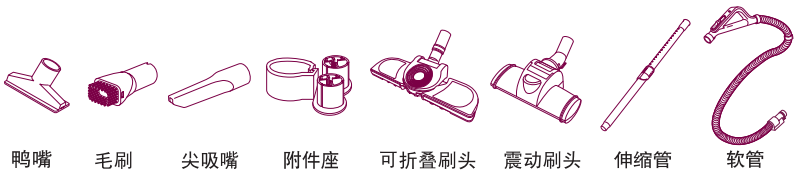

吸力调节

请按图示使用

软管手柄处有一个手动的气流控制扭，使您可以简单方便地调节吸力大小。

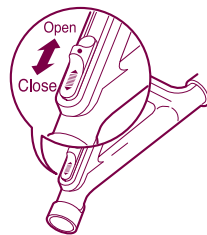

各种附件刷头的使用方法

毛刷、尖吸嘴与鸭嘴的使用

- ▶ 打开塑料袋拿出附件，然后将毛刷及尖吸嘴、鸭嘴装到附件座上，将附件装到钢管的一头。

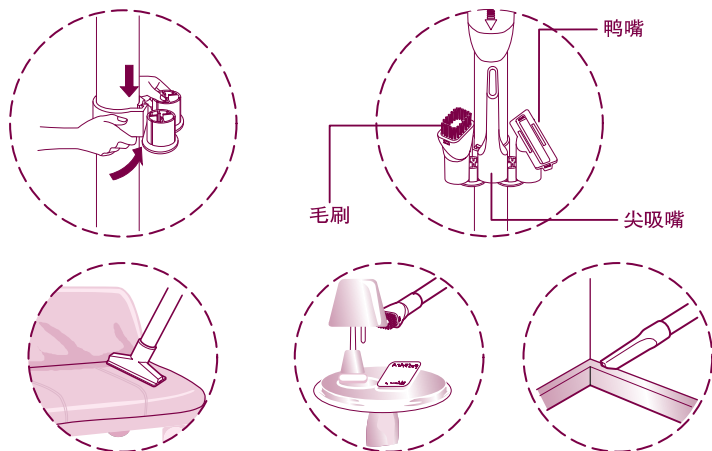

- ▶ 鸭嘴是用来对饰物、床垫等物品进行吸除的。
- ▶ 毛刷用于吸扫画框、家具边沿、书籍和其它不规则的表面。
- ▶ 尖吸嘴是用来吸扫一般不容易接触的地方，如有蜘蛛网的地方或沙发垫子之间的缝隙等。

可折叠刷头的使用

组合

- ▶ 可折叠刷头可以清洁普通地面，也可以折叠成直角来清洁墙角。

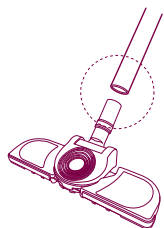

使用

- ▶ 不用再为清扫角落和窄小空间发愁，折叠刷头会给您带来更多便利。

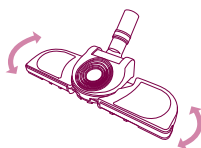

清洁

- 1 用毛刷尖吸嘴清洁

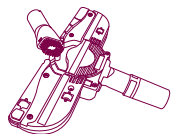

- 2 用棉质抹布擦拭

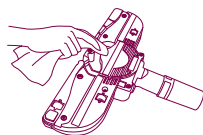

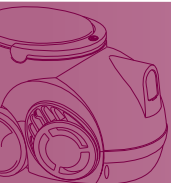

震动刷头使用方法与清洗方法

震动刷头使用方法

请按图示使用

组合

直接与延长管组合

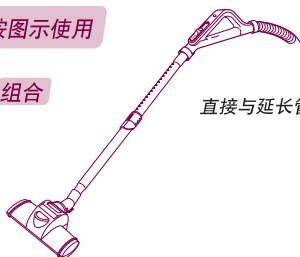

最佳效果清扫方法

● 床、床褥、厚棉被

● 薄被、毛毯

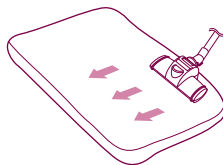
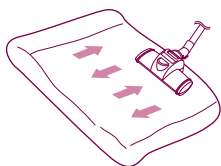

清扫薄被时，下面垫一个厚被，效果更理想！

- 若震动拍不运作，可轻轻向地面敲打刷头后再使用。
- 如还不震动，检查一下振动拍是否被棉絮卡住或需要调大吸力。
- 吸地毯时，根据地毯种类的不同，也会有发生不震动的可能性，所以最好专用于清扫床上用品。
- 集尘筒集满灰尘或吸力减小，震动幅度相应减小时，应注意及时清理滤芯。

震动刷头清洗方法

- ▶ 用毛刷尖吸嘴上的毛刷简单清理震动刷头
- ▶ 内外部都需要清理（吸入口不可用水冲洗，否则有可能产生机器故障）



1 分离刷头底盘



2 擦拭刷头缝隙脏物



3 用水冲洗底盘



4 将底盘嵌入卡槽
将刷头重新装好

- 内部震动结构具有严格的尺寸要求，请勿自行拆开本产品，否则会影响震动性能。注意不要让异物进入振动活塞行腔。
- 请勿拆开震动活塞行腔，否则会对拍打性能产生影响。
- 底盘应很好地与刷头结合后再使用，在重新装好震动刷头前，请确认震动拍是否已放到正确的位置上。如没有底盘震动拍，有可能不运作。
- 请只在清扫床上用品时使用震动刷头。（在普通地面或其他部位使用，会弄脏底盘或出现其他损坏）

集尘筒

集尘筒取放方法

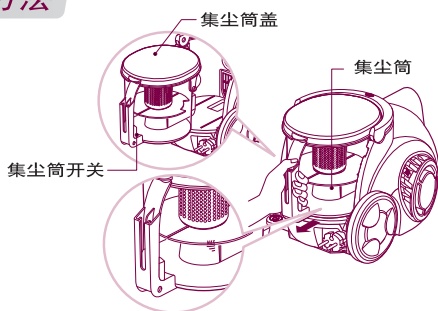

- 灰尘集到MAX线时，请清理集尘筒后再使用。
- 按住集尘筒开关，拉出集尘筒。
- 安装集尘筒时，握住手柄，推至发出“咔嚓”声为止。

集尘筒清洗方法

- ▶ 当灰尘集到MAX线时，需清理集尘筒。
- ▶ 请每月冲洗一次集尘筒。

1 打开集尘筒盖

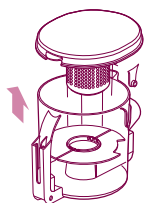

2 拿出集尘筒内挡板 (清洁后请按示意图重新插入)

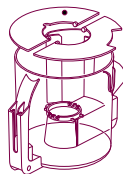

3 用水冲洗



- ▶ 集尘筒内若有螺丝、儿童玩具等小物件进入时，开机运作会使集尘筒瞬间被损坏。
- ▶ 集尘筒内若有长筒丝袜、塑料袋等较大的垃圾物时，请清除后再开机使用。

1 用水清洗集尘筒的过滤器时， 可用软毛刷刷洗。

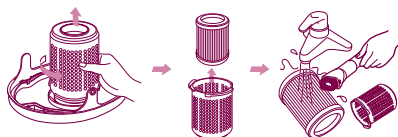

2 放置在阴凉处自然风干。

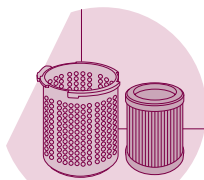

- ▶ 集尘筒过滤器被堵塞后，机器发出异常噪音，然后停止，此时请清理集尘筒内的过滤器，然后重新开启机器使用。

排气海绵的清洗更换/机器的正确保管

排气海绵清洗方法

- ▶ 请至少半年清洗一次，放置在阴凉处风干，或根据使用频率酌情处理。

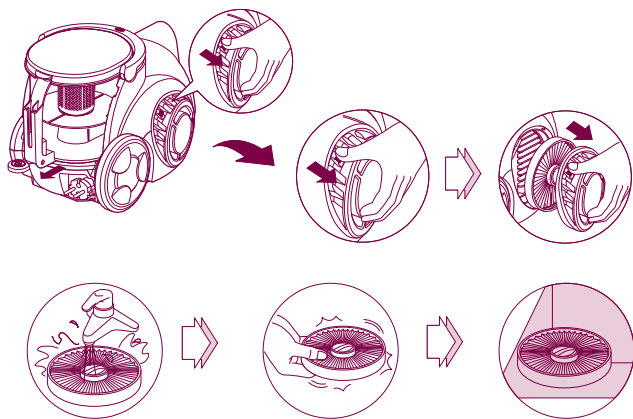

机器的正确保管方法

- 1 拔掉插头，按下卷线器按钮，收起电源线。
- 2 将刷头的定位钩插入集尘筒后面的钩槽中，然后将吸尘器放入适当的位置。

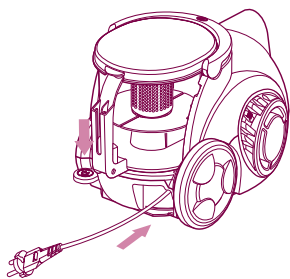

- * 如电源线不能完全收回机体内时，请按下卷线器按钮，拉出一部分线后再重新收回。

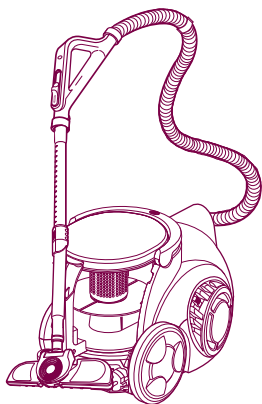

故障通告前需确认事项

故障通告前请先确认

- ▶ 如果您怀疑产品发生故障，请先确认故障发生原因，再与售后服务中心或代理商联系，以确保检修的效率。

现象：
吸力突然
下降！

噪音加大
软管收缩



吸力忽然
下降

吸尘器求助：

请检查集尘筒
和吸入口



处理要领

- ① 查看集尘筒灰尘是否集至MAX线处，如果是，请及时清理集尘筒。



已经满了吗？请及时清理集尘筒哦！

- ② 请确认集尘筒滤芯是否堵塞
请用软毛刷轻轻刷掉滤芯上的灰尘。



滤芯有问题吗？那么检查一下吸入口。

- ③ 检查吸入口时，需将吸力调节到最大。

第一步

将钢管与刷头分离后，检查有无阻塞，如发现问题请立即清理。

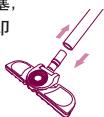

如果还有问题，
请进行第二步。

第二步

分离手柄与钢管，检查有无阻塞，如有阻塞，请将两截钢管分开，清除异物。



如果还有问题，
请进行第三步。

第三步

检查软管是否阻塞，将吸力调至最强，用手堵放管口，反复几次。



如果还有问题，
请清理一下滤芯。



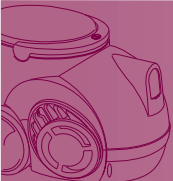



故障通告前需确认事项

故障通告前请先确认

- ▶ 如果您怀疑产品发生故障，请先确认故障发生原因，再与售后服务中心或代理商联系，以确保检修的效率。

故障	检查	措施
<p>吸尘器为何不能工作？</p> 	<ul style="list-style-type: none">• 电源插头是否插上？• 电源插座有电吗？• 电机热保护处于开启期间。	<ul style="list-style-type: none">• 请将电源插牢（本产品适用于220V电压）。• 确认插座是否有电。• 2小时后再重新启动。
<p>机体内有噪音。</p> 	<ul style="list-style-type: none">• 吸尘器吸力过大或电机高速运转时所发出的声音，不属于异常情况，请正常使用。• 如果不是正常的电机响声，而是异常的噪音，请打电话与维修中心联系。• 集尘筒已满。• 集尘筒滤芯堵塞。• 吸入口阻塞。• 钢管阻塞。• 软管阻塞。	<ul style="list-style-type: none">• 清理集尘筒。• 用软毛刷轻轻刷滤芯，用水冲洗后放置于阴凉处风干一天。• 将吸入的异物取出后再使用。• 将钢管内异物取出后再使用。• 将软管内异物取出后再使用。
<p>机体出现异味。</p> 	<ul style="list-style-type: none">• 电机运作时，用于固定电机的橡胶圈会受热而产生少量气味，不会影响运作或使机器发生损坏。• 机器不小心吸入一些水或集尘筒长期不清理时，会有一些异味排出，此时应及时清理集尘筒。	
<p>震动刷头不动作或震幅过小。</p> 	<ul style="list-style-type: none">• 震动刷头是用于清扫床上用品、沙发等织物时使用的。• 清扫地毯时，请使用大刷头。• 检查底盘是否正确地与刷头结合。• 清扫薄织物时，请在下面垫上厚被褥。• 请确认集尘筒和吸入口各部位是否有阻塞现象。• 吸力下降也可能使震幅减小。	
<p>电源线不能全部卷入机体，电源线不能全部拉出。</p> 	<ul style="list-style-type: none">• 将电源线拉出一部分后重新卷入。• 请用力将电源线拉出，不会损坏电源线。• 由于线在内部互相缠绕或夏季周围温度过高所致。• 由于线在内部折曲或未缠在卷线器上，启动卷线器后，能正常运作。	
<p>机体或排出的气体过热。</p> 	<ul style="list-style-type: none">• 吸力是否正常？	<ul style="list-style-type: none">• 从机体内排出的热气，是由电机导热产生的热量所致，属正常温度，请继续使用。
<p>软管内发现有异物。</p>	<ul style="list-style-type: none">• 软管里有异物请及时清理。• 请勿将水吸入，水与灰尘混合吸入后，有可能弄脏管壁。	

装箱单

装箱单

吸尘器	1	台
软管	1	根
伸缩延长管	1	根
可折叠刷头	1	个
震动刷头	1	个
毛刷	1	个
尖吸嘴	1	个
鸭嘴	1	个
附件座	1	个
说明书	1	本
保修卡	1	份

Table of contents

Product specifications	14
Attention before using the appliance	15-16
Assembling and adjusting the Cleaner	17
Parts description and assembly	
Accessories	
Using the Accessories and Elbow Tube	18
Using the Cleaning Head	19
Using and cleaning the Sani Punch	20
Using the Sani Punch	
Cleaning the Sani Punch	
Dust Tank	21
Removing and replacing the Dust Tank	
Cleaning the Dust Tank	
Cleaning the Exhaust Filter / Storage	22
If you have a problem	23-24
Packing list	25

Product specifications

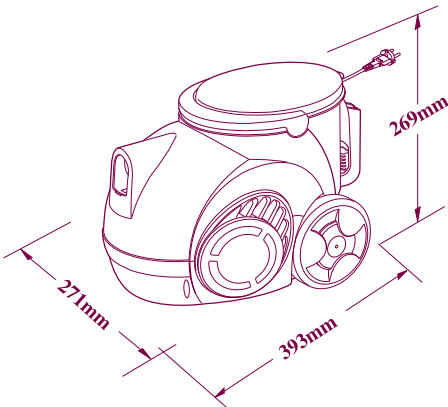

Model: V-774CAY
220V~50Hz
IEC: 1200W
MAX: 1400W
Suction Power: 300W
Net Weight: 4.5KG
Dust Capacity: 1L
Dimension: 393mmx271mmx269mm
This appliance complies with the following GB Directives:
GB4706.1-2005
GB4706.7-2004
GB17625.1-2003
GB4343-2003

※ You will not be informed otherwise of any changes in appearance and standard deriving for improvement of product quality.

Attention before using the appliance

Attention before using the appliance

Please read all the following information, which contains important instructions for the safety, the use of the appliance.



DANGER

May immediately cause serious injury or death.



WARNING

May possibly cause serious injury or death.



ATTENTION

May possibly cause losses of property or light injury.



DANGER

Do not pick up anything that is burning or smoking, such as cigarettes, matches or hot ashes.

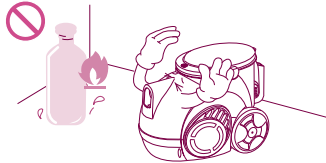

Please turn off the power before pulling out the plug to prevent fire or electric shock. Never handle plug or appliance with wet hands. (Do not use the appliance on the power above 220V.)

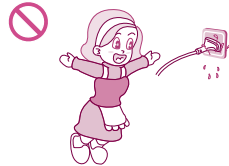

WARNING

Avoid picking up hard, sharp objects with the cleaner. They may damage the cleaner and the tank.

Do not vacuum the objects like hair ball or big paper ball, otherwise the hose is possibly blocked up. Please clear the hose in time when it is blocked.

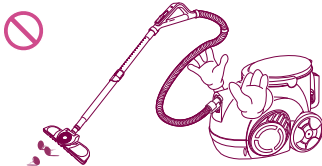

To avoid the danger of fire or electric shock, do not vacuum liquid, blade, flammable substances, or small particles like cement and gesso in cleaning.

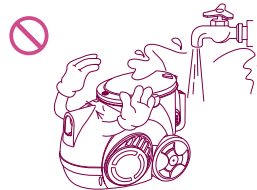

Independently use a socket when the current is $\geq 15A$. It may cause fire when many electric appliances share one socket. In order to avoid the needless danger, you had better not use the prolonged thread of power cord.

Unplug cleaner when not in use. Turn off all controls before unplugging.

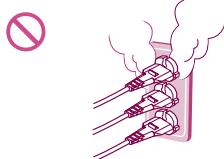

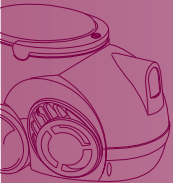

Attention before using the appliance

WARNING

Do not let the power cord near the electric heater or other heat source, lest that the cleaner should be deformed or it should cause fire. Do not use the appliance when the power cord or plug is damaged. The damaged power cord or plug must be replaced in the approved service station.



Close supervision is necessary when any appliance is used by or near children. Do not allow vacuum cleaner to be used as a toy or to run unattended at any time.



Do not operate the appliance for long when the nozzle inlet or nozzle outlet is blocked, which may have it deformed or damaged.



In using the appliance, pay attention to the electrostatic effect generated on the tube and cleaner body.

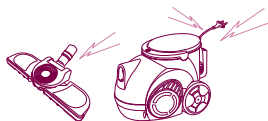

ATTENTION

Do not allow the non-professional maintenance people to repair.

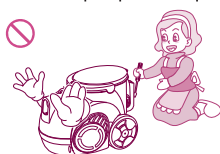

Do not pull or carry by cord, use cord as a handle, close door on cord or pull cord around sharp edges or corners. Do not run appliance over cord. Keep cord away from heated surfaces.

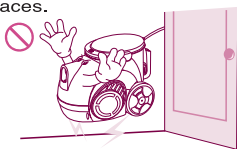

In winding the power cord, hold the plug before pressing the button of the cord reel. Do not pull the power cord beyond the red warning line, other wise the power cord may be damaged or unable to be wound up. Pay attention to the plug in winding the cord to avoid damaging the surrounding objects.



Do not bend, stamp on, or drag the hose. Do not continue to use the hose if it is damaged.

Do not use any heavy or sharp object to press the^P over cord.



Do not use without dust tank or filters in place. Change tank frequently when picking up very fine materials such as powder.

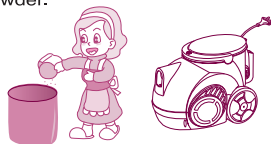

Keep hair, loose clothing, fingers, feet and all parts of body away from the nozzle or movable portion.

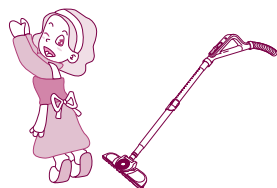

Assembling and adjusting the Cleaner

Parts description and assembly

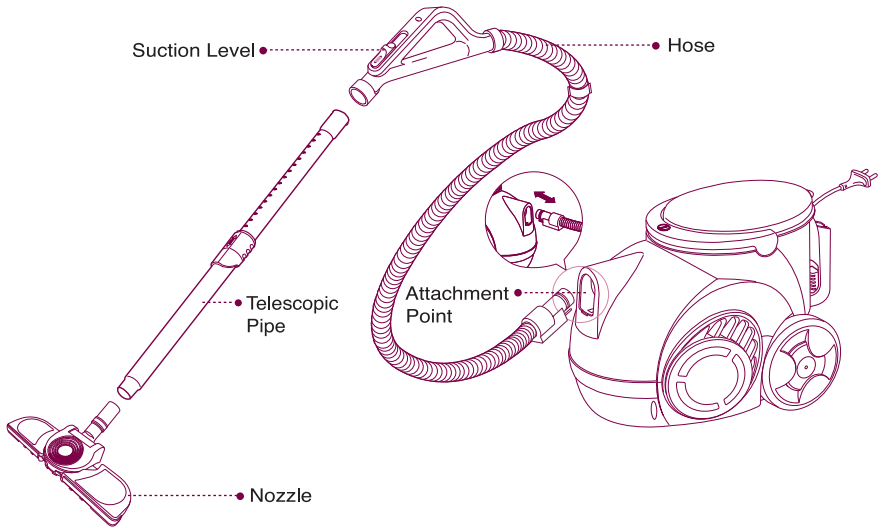

Accessories

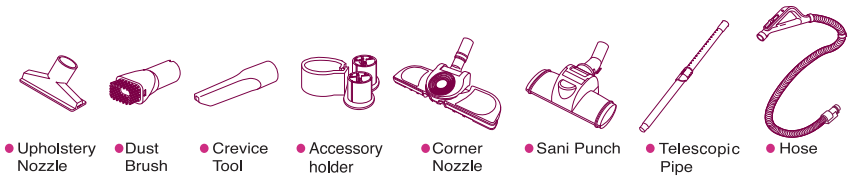

Adjusting the Suction level

Operation

This button can control the suction power easily. You can adjust the suction power use this button.

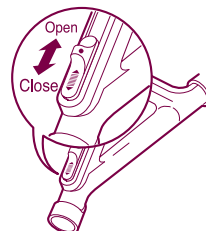

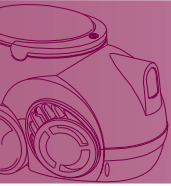

Using the Accessories

Using the Dusting Brush & Crevice Tool and Upholstery Nozzle

- ▶ Tear the vinyl bag and pull out accessories. Attach the accessory holder into tube. And then, fit the Dusting Brush & Crevice Tool and Upholstery Nozzle onto the accessory holder. Fit the accessory onto the end of the tube.

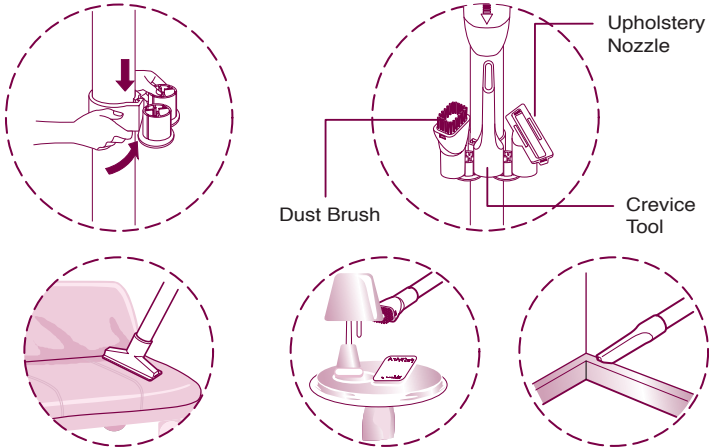

- ▶ Upholstery Nozzle is for vacuuming upholstery, mattresses, etc.
- ▶ Dusting Brush is for vacuuming picture frames, furniture frames, books and other irregular surfaces.
- ▶ Crevice Tool is for vacuuming in those normally hard-to-reach places such as reaching cobwebs, or between the cushions of a sofa.

Using the Corner nozzle

Assembling

- ▶ Push tube into nozzle outlet.

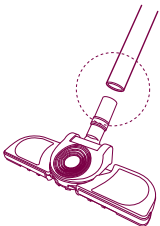

Use

- ▶ This nozzle can be used to clean The corner and floor.

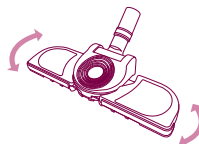

Cleaning

- 1 Using the brush to clean the nozzle

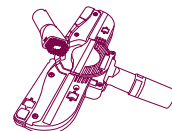

- 2 Wipe all the soiled parts of the vacuum nozzle body with a cloth.

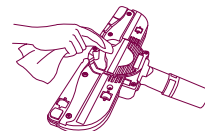

Using and cleaning the Sani Punch

Using the Sani Punch

Use it as shown in the diagram

Assembling

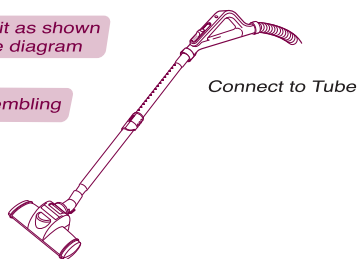

Effective cleaning

• bed, bedding, heavy blanket

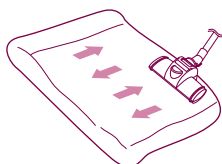

• Light blanket & sheet

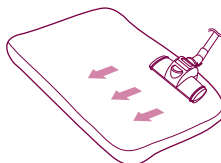

To increase cleaning efficiency for light blankets, lay on top of a bulky blanket and then clean.

- If the punch bar does not move, lift the nozzle slightly off the surface.
- If it does not move, even after doing this, check if the suction power is too low or if the nozzle base is clogged with a foreign object.
- This Sani Punch nozzle is for effective cleaning of beds and blankets to remove mites and dust.

Cleaning the Sani Punch

- ▶ For simple cleaning of the vacuum nozzle, detach the Sani Punch nozzle from the tube and attach the crevice tool to vacuum dust.
- ▶ Follow the instruction below for through washing.  (Do not soak the entire body of the vacuum nozzle in water, it may cause the vibrator to malfunction)



1 Press the button on the rear side of the vacuum nozzle to separate the bottom plate.



2 Wipe all the soiled parts of the vacuum nozzle body with a cloth.



3 Wash the removed bottom plate with water and dry it..



4 Insert the attachment projections on bottom plate to the vacuum nozzle grooves.

- Since the vibrator inside is composed of precision parts, never disassemble the body. Be careful not to let foreign objects clog the air suction part on top of the vacuum nozzle.
- Since removal of the punch bar may cause performance problems, do not warp or remove it.
- Attach the bottom plate properly before using. Without this bottom plate, it may not function.
- Since this vacuum nozzle has been made exclusively for cleaning beds, blankets and upholstery, use it only for these cleaning purposes. (Using it to clean the floor may result soiling it or a drop in performance, do not use it for such purposes.)

Dust Tank

Removing and replacing the Dust Tank

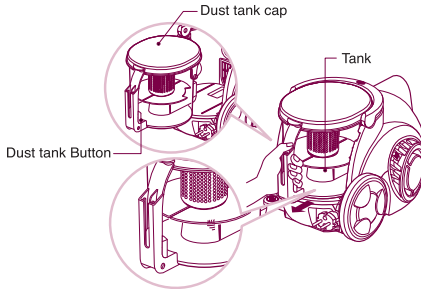

- Make the dust tank empty if dusts are filled to the "MAX".
- Press the button of cover and pull the dust tank forward.
- To reinstall the dust tank, replace the dust tank cap and push the dust tank into the tank mount as far as it will go.

Cleaning the Dust Tank

- ▶ Make the dust tank empty if dusts are filled to the "MAX".
- ▶ The Dust tank should be cleaned at least once a month.

1 Open the dust tank cap.

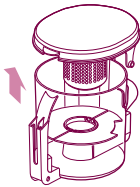

2 Remove two plates from the dust tank.

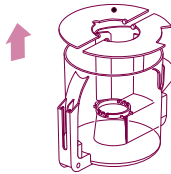

3 Wash both parts with soft cloth. Gently rinse both parts under cold running water.

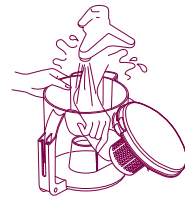

- ▶ Avoid picking up hard, sharp objects with the cleaner. They may damage the cleaner and the tank.
- ▶ Do not vacuum the big objects like plastic or big paper ball. Please clear the dust tank in time.

1 Clean the motor filter with the brush under cold running water.

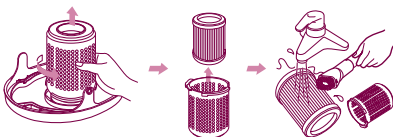

2 Allow the motor filter to dry in a shaded location for a day.

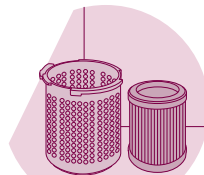

- ▶ Suction power may be weakened when insignificant dusts are sucked. In this case, clean the filter.

Cleaning the Exhaust Filter/ Storage

Cleaning the Exhaust Filter

- The exhaust filter should be cleaned at least once half a year. Allow exhaust filter to dry in a shaded location for a dry.

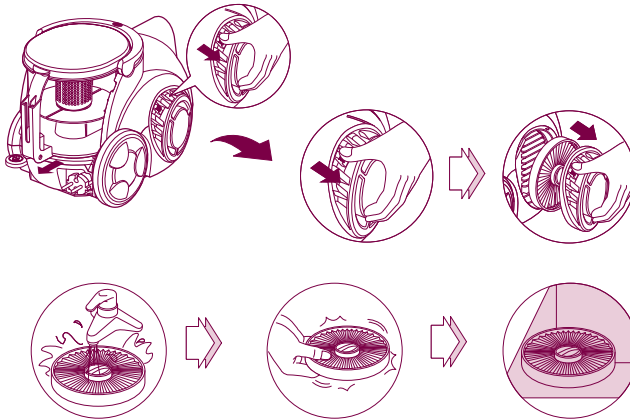

Storage

- 1 When you have switched off and unplugged the appliance, press on the button to automatically rewind the cord.
- 2 To store after vacuuming and pause while vacuuming.
 - For deposit after vacuuming, for example to move a small piece of furniture or a rug, use the Park system to support the flexible hose and cleaning head.
 - Slide the hook on the large cleaning head into the slot on the rear of the dust chamber.

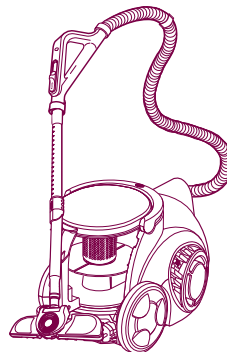
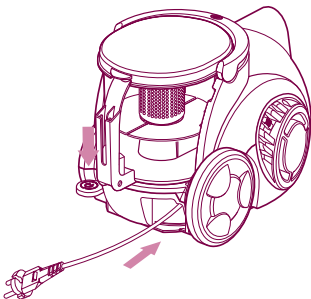

* If the power cord cannot be completely rewound, pull out part of the cord and rewind it again.

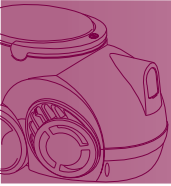

If you have a problem

If you have a problem

► If a minor problem occurs, it usually can be solved quite easily when the cause is found by using the check list below.

Problem:
Suction is weakened.

The noise increases and the hose shrink.



Suction power is abruptly weakened.

Help:

Check the dust tank and suction inlet.



Solution

- 1** Dust tank full.
Empty dust tank.



Is it full? Empty the dust tank in time!

- 2** Motor filter dirty.
Clean the motor filter with brush and water, allow to dry and replace in cleaner.



Is the filter OK? Then check the suction inlet.

- 3** When checking the suction inlet, adjust the suction level to the maximum.

First step

Turn cleaner off and disconnect from electrical outlet, then disconnect nozzle from tube. Check if it is blocked, and remove any blockages.

If there is still a problem, proceed the second step.

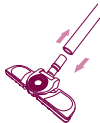

Second step

Disconnect the tube from hose. Check if it is blocked, and remove any blockages.

If there is still a problem, proceed the third step.

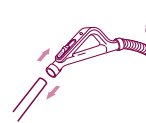

Third step

Plug cleaner in, turn on, and check hose end for suction. Remove any obstructions.







If there is also a problem, clean the filter.



If you have a problem

If you have a problem

► If a minor problem occurs, it usually can be solved quite easily when the cause is found by using the check list below.

PROBLEM	CHECK	SOLUTION
<p>Cleaner won't run.</p> 	<ul style="list-style-type: none">• Not "ON" at hand grip.• Not firmly plugged in.• No voltage in wall plug.• Blown fuse or tripped breaker.	<ul style="list-style-type: none">• Turn "ON" at hand grip.• Plug unit in firmly.• Check fuse or breaker.• Replace fuse/reset breaker.
<p>Noise from cleaner.</p> 	<ul style="list-style-type: none">• The noise is given out when the suction power is too strong or the motor is operating at high speed, which does not belong to abnormal condition. Please use it normally.• If it is not the normal motor sound, please contact the service center.• Dust tank is full.• Motor filter dirty.• Obstruction in suction inlet, tube or hose.	<ul style="list-style-type: none">• Empty dust tank.• Clean filter with water, allow to dry and replace in cleaner.• Remove obstruction.
<p>Strange smell in the appliance body.</p> 	<ul style="list-style-type: none">• A strange smell is produced from the motor mount packing, when the motor is operating. It does not affect the operation or damage the appliance.• When some water is sucked casually into the appliance or the cleaner has not been used for a long time, some strange smell may be exhausted. In this case, timely empty and clean the dust tank.	
<p>Sani Punch won't work, or the punch bar does not move.</p> 	<ul style="list-style-type: none">• Sani Punch is just used to clean bedclothes, sofa and other fabrics.• When cleaning carpet, please use big brush head.• Check whether the bottom plate is correctly connect with the nozzle. When cleaning light blankets, lay on top of a bulky blanket and then clean.• Check if the suction power is too low or if the nozzle base is clogged with a foreign object.	
<p>Power cord cannot be rewind completely, or the power cord cannot be fully pulled out.</p> 	<ul style="list-style-type: none">• Pull out part of the cord and rewind it.• Pull out the power cord forceful, which will not damage the cord.• Because of inter-winding cord inside or high temperature in summer.• It can be normal operated after starting cord reel, when it is due to the cord being twisted or not wound up on the reel.	
<p>Appliance or the exhausted air is overheated.</p> 	<ul style="list-style-type: none">• If the suction power is normal.	<ul style="list-style-type: none">• The exhausted hot air is caused by motor, and belongs to the normal temperature. You can continue to use it.
<p>Inner wall of the hose is blocked.</p>	<ul style="list-style-type: none">• Please clean the hose at time.• Do not suck in water. The combination of water and dusts can possibly dirty the inner wall of the hose.	

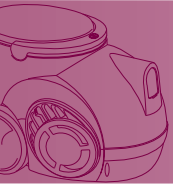

Packing List

Packing List

Vacuum Cleaner	1
Owner's Manual	1
Upholstery Nozzle	1
Dusting Brush	1
Corner nozzle	1
Sani Punch	1
Hose	1
Telescopic Pipe	1
Accessory Holder	1
Crevice Tool	1
Warranty Card	1

如有问题

瞬间感动 Moment Of Truth
LG 售后

请打电话



LG 电子 (天津)电器有限公司

地址: 中国·天津市北辰区兴淀公路

传真: 022-26903476

邮编: 300402

全国技术服务中心服务咨询电话: 400-819-9999



<http://cn.lge.com>

P/No.: MFL32930847